



General catalogue 2016



-45°C

0°C

80°C

Daikin world

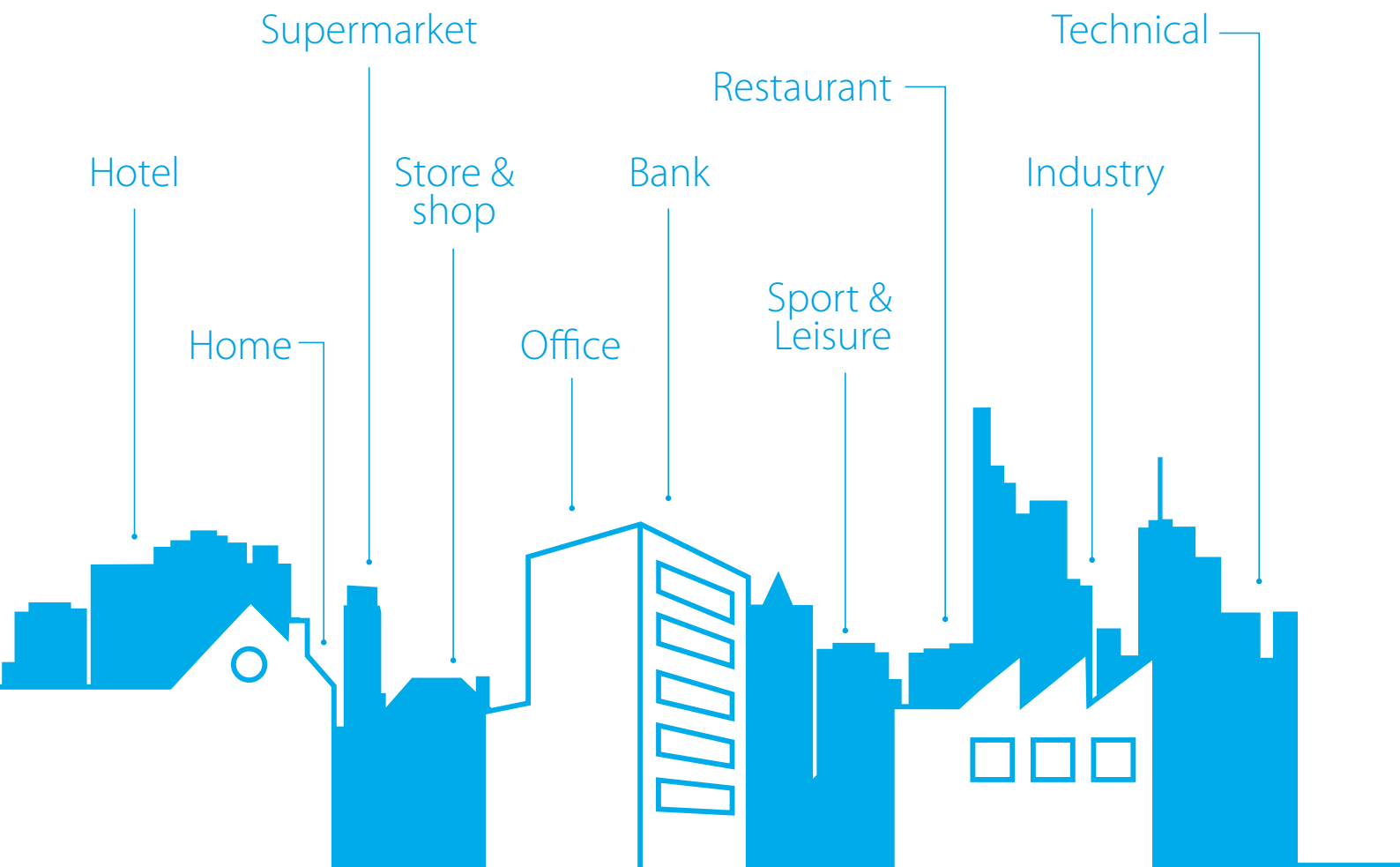

The perfect working environment is essential for all businesses. From supermarkets to offices, from public buildings to hotels, from restaurants to shops it is essential that the quality of the air is optimised at all times – but no space is used in exactly the same way and that calls for flexible, tailored and economic solutions. Daikin, the innovation leader for more than 90 years, understands this and its ‘total solution’ concept is built around customised solutions for individual clients. Whether cooling, heating, ventilation, air curtains or refrigeration with intelligent control systems.

Daikin has the units, the experience and the solution for you. Learn all about our solutions for your business and read more about customer experiences.

Our promise...

... is to ensure that customers can depend on Daikin for the ultimate in comfort, so that they are free to focus on their own working and home lives.

We promise to dedicate ourselves to technological excellence, a design focus and the highest quality standards so that our customers can trust and rely on the comfort we deliver.

Our promise to the planet is absolute. Our products are at the forefront of low energy-usage and we will innovate to further reduce the environmental impact of HVACR (Heating, Ventilation, Air conditioning, Refrigeration) solutions. We lead where others follow.

We will continue our global leadership in HVACR solutions as our specialist expertise in all market sectors combined with 90 years' experience enable us to deliver added value in long-lasting relationships based on trust, respect and credibility.

We promise to continue our forward-thinking ethos, treating challenges as opportunities to produce ever-better solutions. We will drive innovation and go the extra distance for our customers and our company. We will be smart and ready to do things differently.

We will deliver on these core values of our brand and enjoy sustainable success with continued growth.



Table of content

What's new in 2016	4
Why choose R-32 refrigerant?	8
Replacement technology	9
Seasonal efficiency, smart use of energy	10
Tools and Platforms	12
Air purifiers	14

Heating

Source to water heat pumps	19
Daikin Altherma hybrid heat pump	28
Daikin Altherma ground source heat pump	30
Daikin Altherma low temperature	32
Daikin Altherma high temperature split	58
Daikin Altherma Flex Type	64
Domestic hot water heat pump	70
Gas condensing boiler	72

Air conditioning

Residential applications - Split	77
Pair applications	89
Multi model applications	106
Light commercial applications - Sky Air	161
Indoor units	174
Siesta Sky Air	182
Outdoor units	206
Twin, triple, double twin applications	207
Rooftops	212
Commercial applications - VRV	219
Powerful selection programs	226
Outdoor units	234
Indoor units	258
Hot water	282
Ventilation & Biddle Air Curtains	295
Marine Types	313

Applied systems

Chillers	315
Air cooled chillers (Cooling only)	324
Air cooled chillers (Heat pump)	366
Air cooled condensing units	376
Water cooled chillers	378
Condenserless chillers	392
Water cooled centrifugal chillers	398
Fan coil units	407
Air handling units	433

Refrigeration

ZEAS condensing units	456
Conveni-Pack	460
Booster unit	463
Commercial condensing units	464
Industrial condensing unit	467

Control systems

Control systems	470
-----------------	-----

What's new in 2016



p.49 **NEW** E(D/B)LQ-CV3 - Small monobloc

- › Compact heating only and reversible monobloc for space heating & cooling with optional domestic hot water
- › Fuss-free installation : only water connections required
- › Reliable operation even when -25°C outside thanks to frost protection features such as free hanging coil



p.71 **NEW** EKHHP-A2V3+ERWQ-AV3 - Domestic hot water heat pump

- › Domestic hot water is heated almost immediately
- › Combine it with solar heating for even better energy efficiency
- › Easy installation: no water tank pressure and only limited pressure in the heat exchanger
- › Low maintenance: no anode means no scale and lime deposits or corrosion
- › Electrical back-up (2,5 kW) ensures hot water under all circumstances. The 500L tank can also be equipped with an external hydraulic back-up



p.172 **Round flow cassette auto-cleaning panel with finer mesh filter**



- NEW** › For fine dust applications (e.g. clothing shops) a decoration panel with finer mesh filter guarantees optimal working conditions within these high demanding surroundings

For every application a panel:

- Auto-cleaning panel with standard filter BYCQ140DG, white (RAL9010) with grey louvers
- NEW** • Auto-cleaning panel with finer mesh filter BYCQ140DGF, white (RAL9010) with grey louvers
- Full white (RAL9010) panel with standard filter BYCQ140DW
- White (RAL9010) with grey louvers panel with standard filter BYCQ140D

p.241 **NEW** RXYSQ-TV1 / RXYSQ-TV1 / RXYSQ-TY1
VRV IV S-series

- › Widest range of mini units on the market: from 4 up to 12HP
- › RXYSQ4,5T: The most compact (823mm high) and lightweight (88kg) VRV in the market makes the unit almost unnoticeable
- › Either connect VRV or stylish indoor units (Daikin Emura, Nexura)
- › Incorporates VRV IV standards & technologies such as Variable Refrigerant temperature



VRV IV S-series



p.245 **NEW** SB.RKXYQ-T - VRV IV heat pump for indoor installation

The invisible VRV

- › Unique VRV heat pump for indoor installation
- › Total flexibility for any shop location and building type as the outdoor unit is invisible and split up in 2 parts
- › Highly suited to densely populated areas thanks to the low operation sound and seamless integration into surrounding architecture
- › Incorporates VRV IV standards & technologies such as Variable Refrigerant temperature
- › Lightweight units reduce installation time and effort



VRV IV i-series



p.253 **NEW** RWEYQ-T8 - Water cooled VRV IV

- › Connectable to the most extended and compact range of BS boxes (BS1Q-A / BS-Q14A)
- › Ideal for high-rise buildings, using water as heat source
- › Unified range for geothermal and standard series and heat pump and heat recovery
- › Incorporates VRV IV standards & technologies such as Variable Refrigerant temperature
- › 2-stage heat recovery: between indoor units and between outdoor units via the water circuit



VRV IV W-series





p.282 **VRV hydroboxes compliant with Eco-design legislation**

- NEW** › LT hydrobox HXY-A8 and HT hydrobox HXHD-A8 fully Eco-design compliant thanks to new pump
- › For efficient space cooling/heating and hot water production
- › Free heating provided by transferring heat from areas requiring cooling to areas requiring heating or hot water
- › Saves time on design and installation as all water-side components are fully integrated with direct control over leaving water temperature



p.298 **VAM-FC compliant with Eco-design legislation**

- NEW** › Fully compliant with the new Eco-design legislation coming into force 01/01/2016
- › Energy saving ventilation using indoor heating, cooling and moisture recovery
- › Free cooling possible
- › Prevent energy losses with optional CO₂ sensor
- › High efficiency filters available



p.328 **NEW** EWAQ-G - EWYQ-G-
p.370 **Air cooled scroll chiller and heat pump**

- › Single refrigerant circuit (2 scroll compressors) with single evaporator
- › Compact design to allow easy indoor installation or retrofit operations
- › Micro channel heat exchanger technology reduces the amount of refrigerant used in the system, lowering environmental impact
- › Partial and total heat recovery option available
- › Stainless steel plate heat exchanger

p.382 **NEW** EWHQ-G-/EWWQ-G-/EWWQ-L-/
 p.383 EWLQ-G-/EWLQ-L-
 p.384 Water cooled scroll (condenserless) chiller
 p.393 and heat pump
 p.394

- › Single refrigerant circuit (2 scroll compressors) with single evaporator (EWWQ-G-SS)
- › Dual refrigerant circuit (4 scroll compressors) with single evaporator (EWWQ-L-SS)
- › Conceived for stacked installation to reduce the footprint (EWWQ-G-SS)
- › Heat pump version with reversibility on refrigerant side, ideal for geothermal applications (EWHQ-G-SS)
- › For chilled water production, to be combined with a remote condensing unit (EWLQ-G-SS/EWLQ-L-SS)
- › Compact design to allow easy indoor installation or retrofit operations
- › Master/slave control (standard available) allows sequencing control (up to 4 units) without any external device
- › Pump (low 100 kPa and high 200 kPa lift) available for evaporator and condenser



p.475 **COMING**
SPRING 2016 BRC1E53A/B/C - Wired remote control with
 duty rotation

- NEW**
- › Replaces BRC1E52A/B in Spring 2016 and includes following additional functionalities:
 - Duty rotation and back-up for infrastructure cooling
 - Remote control save mode : screen turns off when no person is changing mode or adjusting settings
 - Demand control: decreases the power consumption to 70 or 40 % when other large appliances need to be switched on
 - Selection of quiet mode function for the outdoor unit



p.482 **NEW** DCC601A51 - Centralised touch controller
 with cloud connection

- › Centrally control your building (air conditioning, window contact, ...)
- › Intuitive and user-friendly interface
- › Stylish optional screen fits any interior
- › Plug&play installation

Cloud package options:

- › Online control: control your system no matter where you are
- › Multi site: control and compare the energy use of multiple sites
- › Energy saving: Maximize your air conditioning system operation automatically and keep track of your energy use





Why choose R-32 refrigerant?

Ten years ahead of legislation

Improving indoor comfort while having a low environmental impact. With this in mind, Daikin launched the **first worldwide air conditioners with R-32 refrigerant in Japan at the end of 2012**, where millions have since been installed. Meanwhile, R-32 models have been introduced in many other countries and since 2013 as a first in Europe.



Did you know?

The new European F-gas regulation 517/2014 includes a ban on some refrigerants in certain applications. R-32 is a perfect answer to this.

Daikin has introduced R-32 models 10 years ahead of time. The sooner the industry changes to lower GWP refrigerants, the better for the environment.

GWP is not the only parameter

There is no refrigerant which can meet the needs of every kind of application. This means that Daikin had to evaluate its options carefully, taking into account not only the GWP or amount of refrigerant used, but also aspects such as energy efficiency, safety and affordability.

For example, selecting a refrigerant with a lower GWP but which uses more energy would not be a good choice, as it would be counterproductive for the total product's global warming impact.

Daikin, followed by other industry players, selected R-32 because it contributes to the EU F gas regulation targets, whilst being energy efficient, safe and affordable.

Advantages of R-32

The chemical name for R-32 is difluoromethane. It has been used for many years as a component of the refrigerant blend R-410A. Daikin and others in the industry recognise the advantages of using R-32 in its pure form.

	R-410A	R-32
Composition	Blend of 50% R-32 + 50% R-125	Pure R-32 (no blend)
GWP (Global Warming Potential)	2087.5	675
ODP (Ozone Depletion Potential)	0	0

Compared to R-410A, the GWP (Global Warming Potential) of R-32 is only one third, while it allows for a much smaller refrigerant volume. It contributes to the EU F-gas regulation targets, while being energy efficient, safe and affordable. R-32 is also easier to recycle and re-use. In addition, R-32 is easy to handle for installers and service technicians as it can be charged in both liquid and gas phase. And there is no need to worry about fractionation or glide problems.

Comparison example for Daikin Emura 3.5 kW model available in R-410A and R-32 version

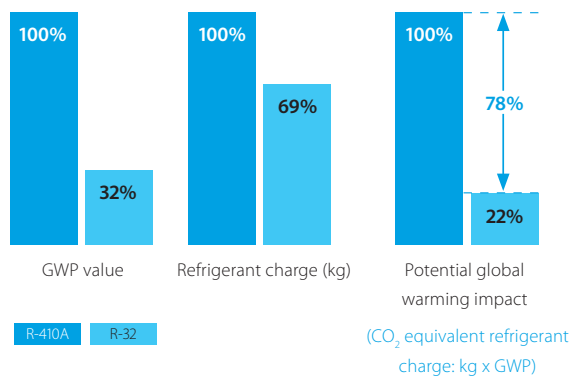

Replacement technology

Replacement technology

The quick and quality way of upgrading R-22 and R-407C systems

Service and maintenance with R-22 is prohibited from 01/01/2015 onwards, meaning repairs are impossible to R-22 systems. Avoid unexpected downtime for your customers and replace these systems now!



Installer benefits

Less installation time

Tackle more projects in less time thanks to **faster installation**. It is more profitable than replacing the full system with new piping.

Lower installation costs

Reducing installation costs enables you to offer customers the most **cost-effective** solution and improve your competitive edge.

Replace competitor systems

It is a trouble-free replacement solution for Daikin systems and for systems made by other manufacturers.

Optimize your business

A simple solution for replacement technology enables you to **handle more projects** for more customers in less time and offer them the best price! Everybody gains.

Keep your refrigerant piping

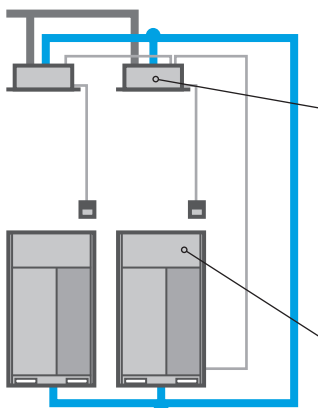

The Daikin low-cost upgrade solution

! Replace indoor units and BS boxes

Contact your local dealer to check compatibility in case you need to keep the indoor units.

! Replace outdoor units

Customer benefits

Save on running costs

Comparison based on EER

(efficiency of a residential product in cooling mode)



Comparison based on SEER

(efficiency of a residential product according to current seasonal legislation of a product in cooling mode)



No disturbance

Re-use your **existing piping** ensuring a quick and quality replacement allowing work to be done without affecting your comfort or business

Upgrade your comfort

Upgrade your comfort with cutting-edge design, low noise levels, WIFI controls and more...

It's all about A



New energy labels for heat generators and water heaters



From September 26, 2015, all space heating and hot water systems are required to display a label which clearly indicates the system's efficiency class. The new labelling requirements follow on from the adoption in 2010 of the energy labelling Directive (2010/30/EU). The primary aim of the Directive has been to remove poorly performing, energy inefficient products from the market. Only heat pumps with an efficiency class of A+ (for 55°C) or A (for low temperature heat pumps declared at 35°C) and better will be allowed in the market. Condensing gas and oil boilers will need at least a B label.

Daikin has been proactive in addressing the new energy requirements, through further improvements and additions to Daikin heating and hot water systems which guarantee energy efficiency to an 'A' grade or higher.

Find out more on www.daikineurope.com



Daikin leads the way...

Seasonal efficiency, Smart use of energy



Challenging 20-20-20 environmental targets with Europe's energy label

The European Commission has set challenging targets for improving energy efficiency in the EU. These so-called 20-20-20 targets aim at a 20% reduction in CO₂ emissions, 20% share of renewable energy and a 20% reduction in the use of primary energy, all by the year 2020. To realise these objectives, Europe issued the Eco-Design Directive [2009/125/EC]. This sets minimum efficiency requirements for energy related products.

Air-to-Air heat pumps

Since 2013, all air conditioners and air-to-air heat pumps under 12 kW are in scope of this Eco-Design Directive. Products unable to comply with the minimum efficiency requirement (such as non-inverter air conditioners) will lose their CE marking and thus may no longer be sold in the European Union.

To inform consumers concerning these new energy performance standards, Europe also introduced a new energy label. The former European energy label, introduced in 1992, has had its effect. Consumers were able to compare and make purchasing decisions based on uniform labelling criteria. The new label that came into force on 1 January 2013 allows end-users to make even better informed choices, since seasonal efficiency reflects air conditioner efficiency over an entire season.

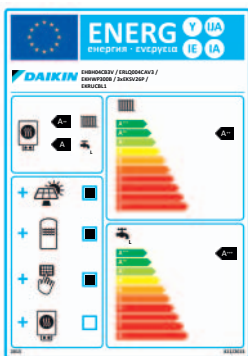

The energy label includes multiple classifications from A+++ to D reflected in colour shadings ranging from dark green (most energy efficient) to red (least efficient). Information on the label includes not only the new seasonal efficiency ratings for heating (SCOP) and cooling (SEER), but also annual energy consumption and sound levels.

Heating systems

Since September 2015, space heaters, combi heaters (Lot 1) and domestic hot water heaters (Lot 2) need to comply with these 20-20-20 targets. This gives the opportunity to the end user to choose the most efficient heating system for his specific solution by for example comparing oil boilers with air-to-water heat pumps.

Ventilation

The EU has decided to extend this system of minimum seasonal efficiency requirements and energy labels also to ventilation systems, from January 2016 onwards. Ecodesign data will be required for both VAM units and air handling units. Energy labels for VAM units only.

Refrigeration

Next to heat pumps, heat generators, water heaters and ventilation also refrigeration units needs to comply to minimum efficiency requirements. From July 2016 onwards, commercial condensing units and ZEAS will be in scope of this new EU legislation.

Although legislation for ventilation will only come into force from January 2016 onwards, and for Refrigeration from July 2016 onwards Daikin is already preparing their units and communication tools to be ahead of legislation again.

Tools and platforms

We're here to help you!

Literature

See all the literature available

- › for you
- › for your customers



[www.daikineurope.com/
support-and-manuals/catalogues](http://www.daikineurope.com/support-and-manuals/catalogues)

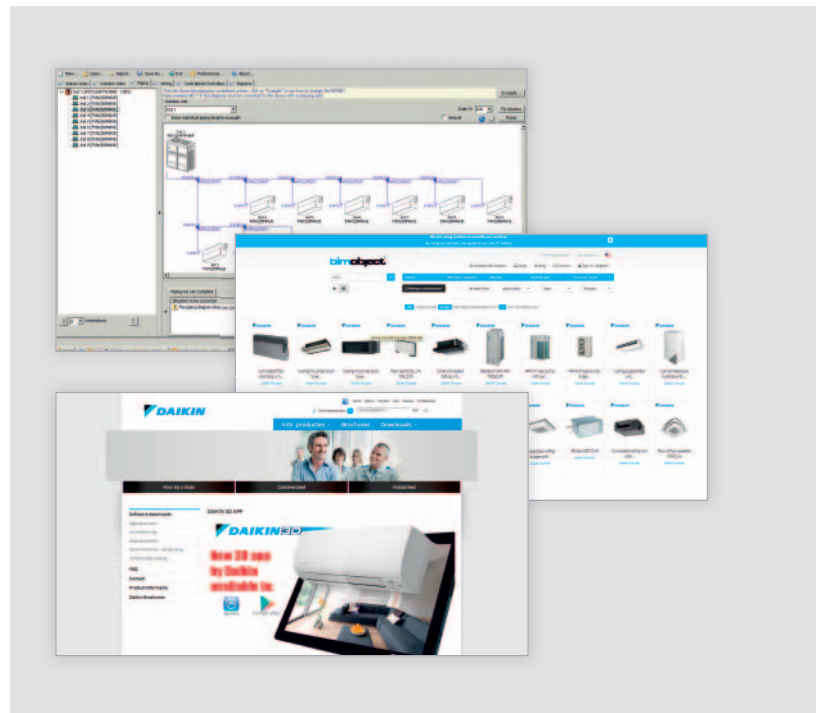

Sales supporting apps

We offer a variety of building modelling, selection, simulation and quotation software tools to support your sales.

[www.daikineurope.com/
support-and-manuals/
software-downloads](http://www.daikineurope.com/support-and-manuals/software-downloads)

Some of our most used apps:

There's an
app
for that

- › **Daikin Altherma simulator:** for appropriate heat pump selection
- › **3D app:** Allows you to choose the air conditioning and watch it at home BEFORE you buy!
- › **Error code app:** quickly know the meaning of fault codes for each product family
- › **Load calculation tool:** helps you to calculate the heat and cool load of your building
- › **Multi selection tool:** for quick calculation of multi split combinations & piping lengths
- › **Xpress:** quick quotation tool for VRV
- › **Astra:** AHU design software
- › **BIM models** for VRV units



Online support

NEW Business portal

- › Experience our new extranet that thinks with you at my.daikin.eu
- › Find information in seconds via a powerful search
- › Customise the options so you see only info relevant for you
- › Access via mobile device or desktop

my.daikin.eu



Internet

Find our solution for different applications:

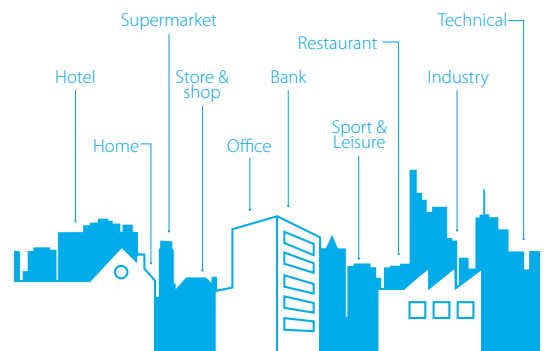

- › Get more commercial details on our flagship products via our dedicated minisites

[www.daikineurope.com/
commercial/applications](http://www.daikineurope.com/commercial/applications)

[www.daikineurope.com/
industrial/applications](http://www.daikineurope.com/industrial/applications)

- › See our references



www.daikineurope.com/references



Pure air

Because Daikin cares

MC70L

The streamer technology air purifier, a blend of new technology, improved performance, and ultra quiet operation, is designed to care for you by unobtrusively providing **purified air** to produce a healthy home environment. Purified air improves the perception of **comfort** and, by **removing** and destroying **contaminants** and **odours**, the streamer technology air purifier also plays an essential role for those who suffer from **asthma** or **allergies**. These efforts place the streamer technology air purifier among the best residential air purifiers on the market today.

Three times purification, a good deed for your health

Pollen, dust and pet hair are just some of the potential causes of allergies, asthma and respiratory problems. A Daikin air purifier cleans the air and relieves you of these troubles thanks to a three-part operation:

- allergen removal
- virus and bacteria removal
- odour removal

What is the Daikin streamer technology ?

“Streamer Discharge” is a type of plasma discharge in which high speed electrons capable of **oxidative decomposition** are generated. It has the ability to **eliminate bacteria** and **mould** as well as hazardous **chemical substances** and **allergens**, etc. Compared to standard plasma discharge (glow discharge), the discharge range of Daikin’s Streamer Discharge is wider, which makes it easier for electrons to collide with oxygen and nitrogen in the air. This enables high speed electrons to be generated three dimensionally over a wide area, which results in an oxidative decomposition speed that is over 1,000 times greater with the same electrical power. Daikin’s Streamer Discharge technology has proven successful in stably generating high speed electrons, a feat that has been considered difficult up to now.

Main specifications

Daikin has already received great praise for its air purifiers: a British Allergy Foundation seal of approval and the TÜV Nord test mark confirm the efficiency of our units.

Six-layer powerful decomposition and removal configuration

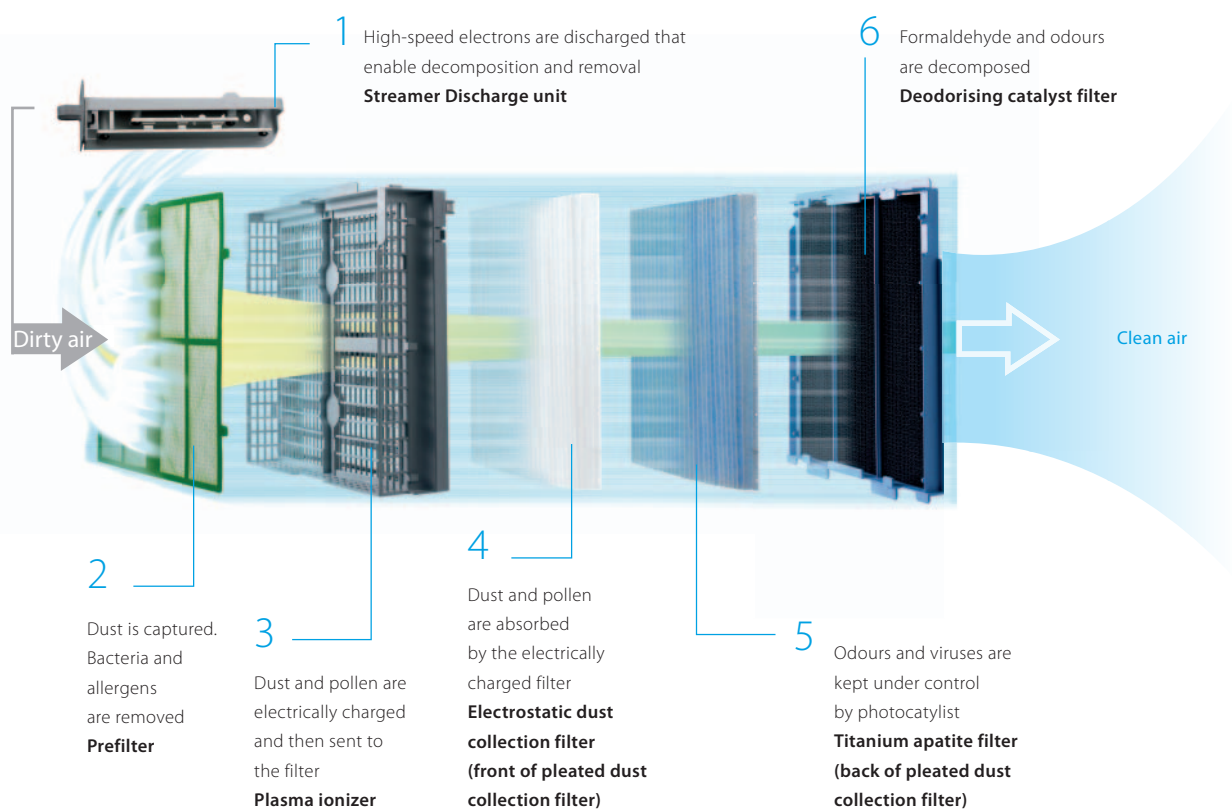

- Stylish design
- Improved performance
- Unprecedented comfort
- Super quiet operation
- Easy to maintain
- Portable
- No installation



Indoor unit				MC70L
Applicable room area			m ²	46
Dimensions	Unit	HeightxWidthxDepth	mm	576x403x241
Weight	Unit		kg	8.5
Casing	Colour			White
Fan	Type			Multi Blade Fan (Sirocco fan with shroud assembly)
	Air flow rate	Air purifying operation	Turbo/High/Medium/Low/Silent	m ³ /h 420/285/210/130/55
Sound pressure level	Air purifying operation	Turbo/High/Medium/Low/Silent		dBA 48.0/39.0/32.0/24.0/16.0
Air purifying operation	Power input	Turbo/H/M/L/Silent		kW 0.065/0.026/0.016/0.010/0.007
Deodorizing method				Flash streamer / Titanium apatite photocatalytic filter / Deodorising catalyst
Bacteria filtering method				Flash streamer / Titanium apatite photocatalytic filter
Dust collecting method				Plasma ionizer / Electrostatic dust collection filter
Sign	Item	01/02/03/04/05/06/07/08/09/10/11		Dust: 3 stages/Odour: 3 stages/Automatic operation (LL-H)/Airflow rate (LL/L/M/H)/Turbo mode (HH)/Anti-pollen mode/Sleep mode/Lock (Anti-tamper)/Off timer (1.2.4h)/Maintenance: Filter replacement/Maintenance: Cleaning of ionization/streamer
Power supply	Phase/Voltage		V	1~/220-240/220-230



Humidification and purification in one

MCK75J

There are many substances in the air you breathe such as allergen, bacteria, virus and tobacco smoke, which causes your health to suffer. Above all things, dryness is especially a big issue during wintertime. Daikin Ururu Air Purifier **purifies and moisturizes** the air inside your home and relieves the effects of dry air. Just fill the 4l tank occasionally and it will humidify your room with a maximum volume of 600ml/h. This useful and innovative function stems from the incorporation of a slim line water tank and combined water wheel and vaporisation filter assembly.

- Humidification thanks to the slim water tank
- Air purification

How does the humidification function work?

Water in the tank flows into the receiver tray housing the water wheel, which lifts the water as it rotates and releases it onto the filter. Air blown onto the filter, absorbs its moisture and discharges it into the room as humidification.

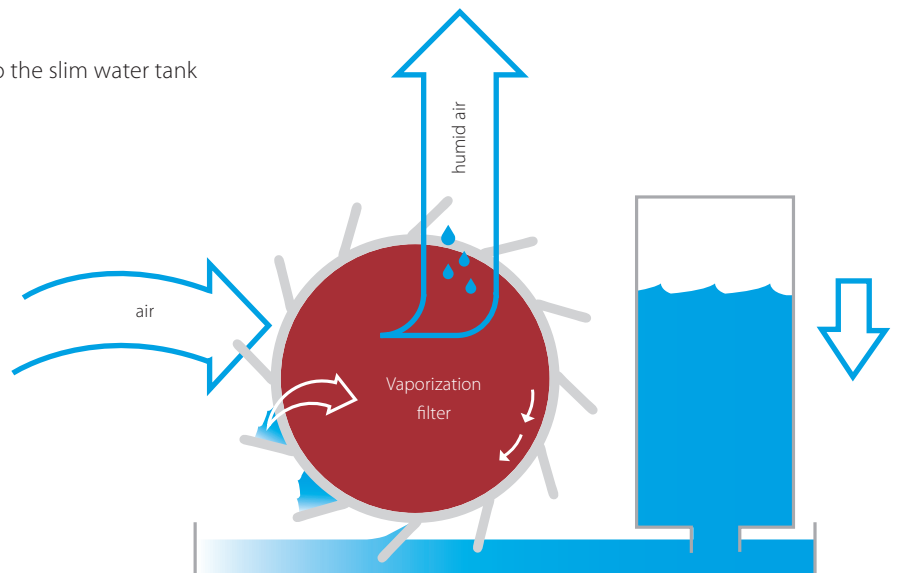

Daikin has already received great praise for its air purifiers: the Daikin TÜV award confirms the efficiency of this unit.

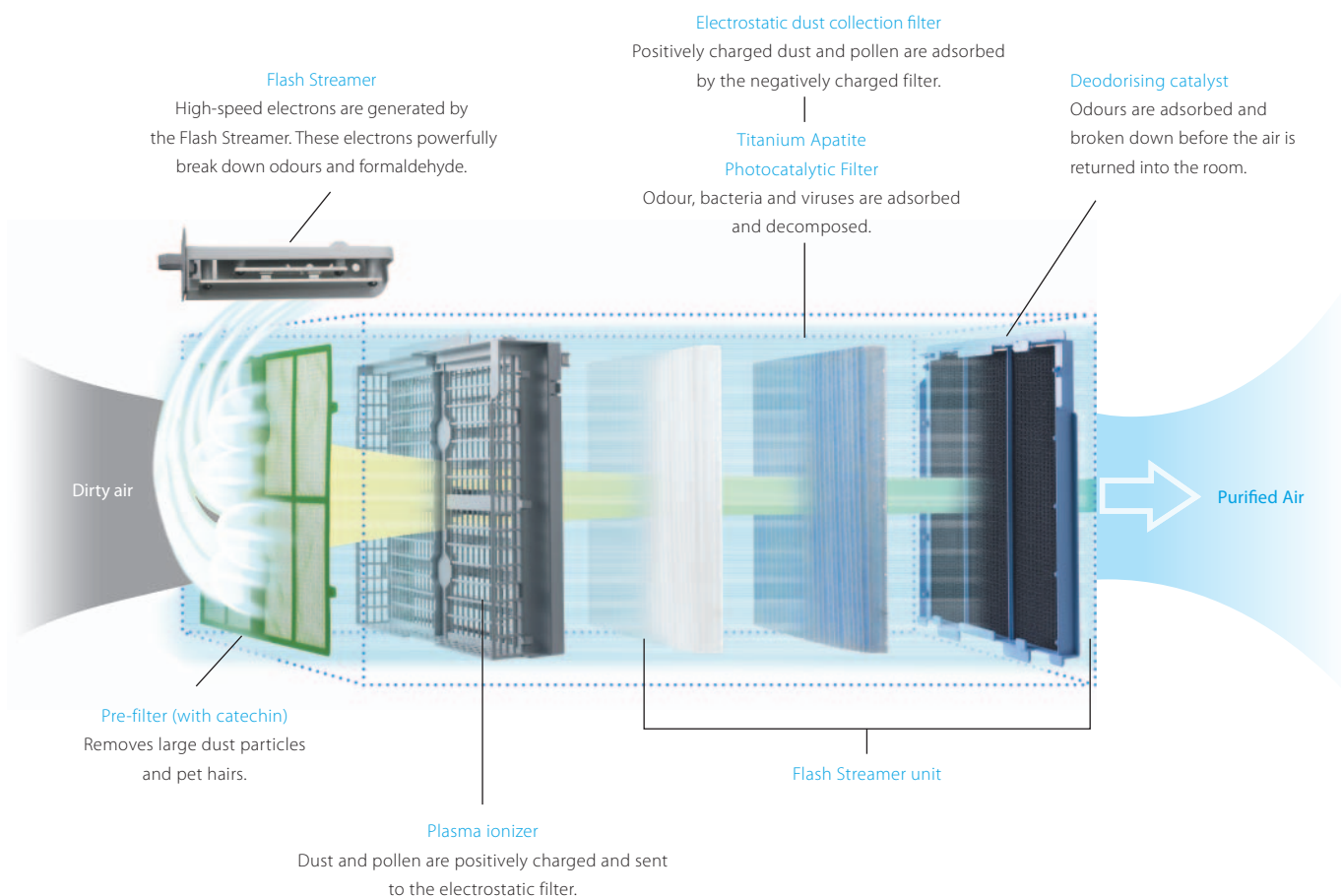

How does the filter work?

Daikin Ururu Air Purifier also removes efficiently allergens (e.g. pollen, house dust mites, dust, etc.), bacteria and viruses. Additionally, it has a high deodorizing efficiency; it eliminates efficiently tobacco smoke whilst decomposing other smells. It quickly collects particles and breaks them down rapidly. Its quiet operation makes it ideal for quiet nights. The unit includes seven pleated filters (one for immediate use and 6 spares).

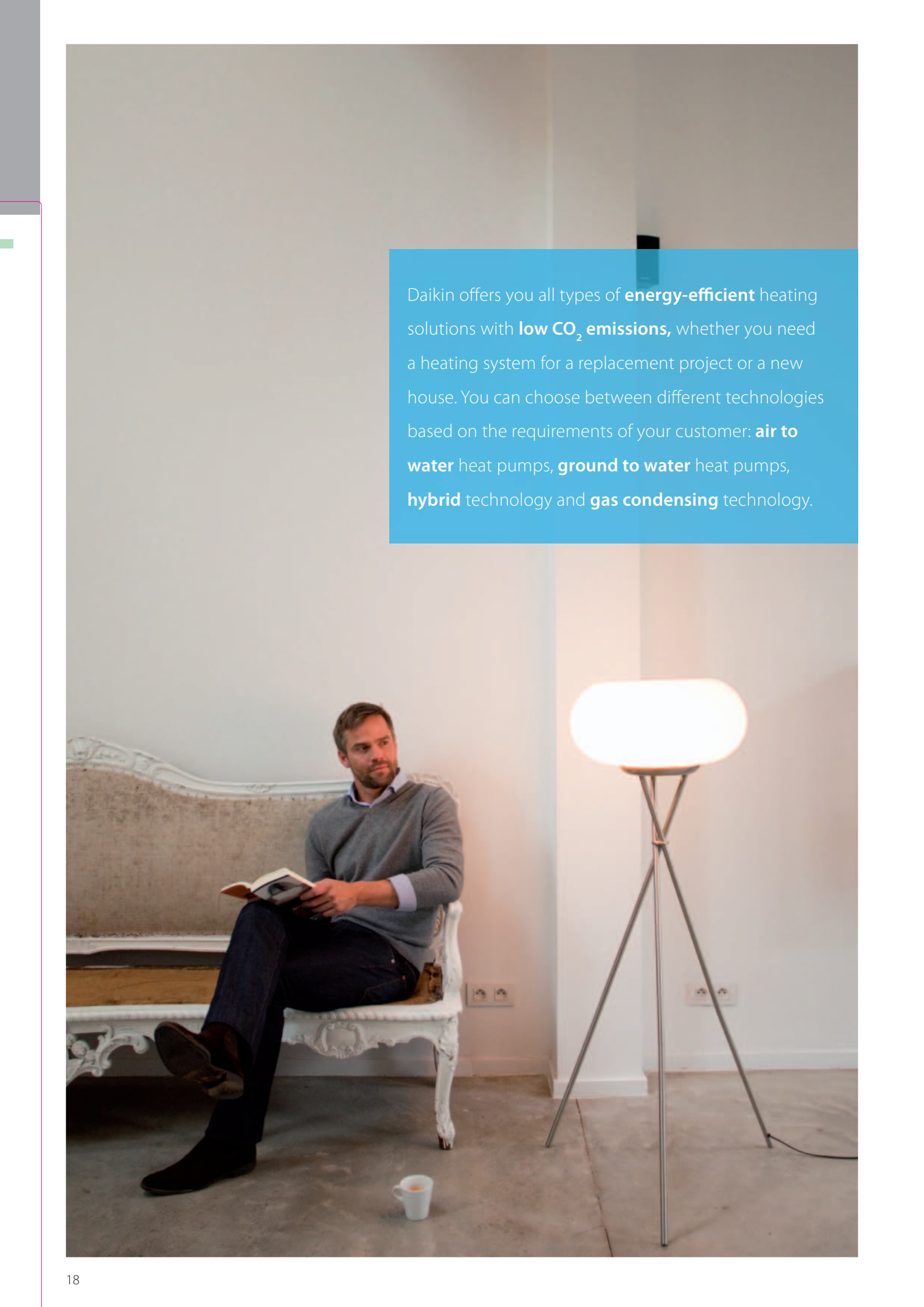

Indoor unit				MCK75J	
Application	Floor standing type				
Applicable room area	46 m ²				
Dimensions	Unit	HeightxWidthxDepth	590x395x268 mm		
Weight	Unit	11.0 kg			
Casing	Colour: Black (N1) (Panel colour: silver)				
Fan	Type: Multi Blade Fan (Sirocco fan with shroud assembly)				
	Air flow rate	Air purifying operation	Turbo/High/Medium/Low/Silent	m ³ /h	
				450/330/240/150/60	
		Humidifying operation	Turbo/High/Medium/Low/Silent	m ³ /h	
				450/330/240/150/120	
Sound pressure level	Air purifying operation	Turbo/High/Medium/Low/Silent	50.0/43.0/36.0/26.0/17.0 dBA		
	Humidifying operation	Turbo/High/Medium/Low/Silent	50/43/36/26/23 dBA		
Humidifying operation	Power input	Turbo/H/M/L/Silent	0.084/0.037/0.020/0.013/0.012 kW		
	Humidification	Turbo/High/Medium/Low/Silent	600/470/370/290/240 ml/h		
	Water tank capacity	4.0 l			
Air purifying operation	Power input	Turbo/H/M/L/Silent	0.081/0.035/0.018/0.011/0.008 kW		
Deodorizing method	Flash streamer / Titanium apatite photocatalytic filter / Deodorising catalyst				
Dust collecting method	Plasma ionizer / Electrostatic dust collection filter				
Sign	Item	01			
	Dust: 3 stages / Odour: 3 stages / Air flow rate: auto/LL/L/M/H, Turbo mode HH, anti-pollen mode / Off timer: 1/4/8h / Cleaning: ionization/streamer				
Power supply	Name/Phase/Frequency/Voltage	VM/1~/50/60/220-240/220-230 Hz/V			
Type	Humidifying air purifier				

A man with a beard, wearing a grey sweater and dark pants, is sitting on a white ornate chair, reading a book. To his right is a tall, modern floor lamp with a glowing white oval shade and a tripod base. A small white cup sits on the floor in front of him. The background is a plain white wall with a light switch and a power outlet.

Daikin offers you all types of **energy-efficient** heating solutions with **low CO₂ emissions**, whether you need a heating system for a replacement project or a new house. You can choose between different technologies based on the requirements of your customer: **air to water** heat pumps, **ground to water** heat pumps, **hybrid** technology and **gas condensing** technology.

Heating

Why choose a Daikin heating system? 20

Products overview 24

Combination tables 26

Daikin Altherma hybrid heat pump	28
EHYHBH-AV32/EHYKOMB-AA / EVLQ-CV3	29
EHYHBX-AV3/EHYKOMB-AA / EVLQ-CV3	29
Daikin Altherma ground source heat pump	30
EGSQH-A9W	31
Daikin Altherma low temperature	32
EHVH-CB / ERLQ-CV3/W1	34
EHVH-CB / ERHQ-BV3/W1	35
EHVX-CB / ERLQ-CV3/CW1	36
EHVX-CB / ERHQ-BV3/BW1	37
EHVZ-CB / ERLQ-CV3/CW1	38
EHVZ-CB / ERHQ-BV3/W1	39
EHSB-A / ERLQ-CV3/W1	40
EHSB-A / ERLQ-CV3/W1	41
EHSX-A / ERLQ-CV3/W1	42
EHSXB-A / ERLQ-CV3/W1	43
EBBH-CB / ERLQ-CV3/CW1	44
EBBH-CB / ERHQ-BV3/BW1	45
EBBX-CB / ERLQ-CV3/CW1	46
EBBX-CB / ERHQ-BV3/BW1	47
E(B/D)LQ-CV3 / EK(2)CB-CV3 / EKMBUH3V3/9W1	49
EB(L/H)Q-BB6V3/W1	50
ED(L/H)Q-BB6V3/W1	51
Domestic hot water tanks	52
EKHWP-B/PB	52
EKHWE-A	53
EKHWS-B	53
Solar connection	54
EKSRRPS4	54
EKSRRDS2	54
EKS(V/H)-P	55
Room thermostat	56
EKRUCBL/S	56
EKRTR	56
EKTRW	56
Daikin heat pump convector	57
FWXV-A	57

Daikin Altherma high temperature split	58
EKHRD-AD / ER(R/S)Q-A	60
Domestic hot water tanks	61
EKHTS-AC	61
EKHWP-B	62
Solar connection	63
EKS(H/V)-P	63
EKSRRPS4	63

Daikin Altherma Flex Type	64
EKHVM(R/Y)D-AB	65
EKHRD-AD	66
EMRQ-A	67
Domestic hot water tanks	68
EKHWP-B	68
EKHTS-AC	68
Daikin heat pump convector	69
FWXV-A	69

Domestic hot water heat pump	70
EKHHP-A2V3 / ERWQ-AV3	71

Gas condensing boiler	72
RTRNETA3AA	72
EKOMB(G)-A	73

Options & accessories 74

All-in-one heating comfort for residential & commercial applications



Why choose a Daikin heating system?

- More than **50 years of experience** in heat pumps
- Innovative heating technologies to **reduce running costs** and optimise renewable energy usage
- Research and development **in Europe for Europe**
- A solution for any application
- Combinable with **all kinds of heat emitters**

Solutions for space heating and domestic hot water



- Air to water technology:** extracting heat from the outside air
- › Guaranteed heating capacity down to -25°C: no need to worry in winter time
 - › Solar connection possible for domestic hot water support to optimise renewable energy use



- Hybrid technology:** gas condensing technology combined with air-to-water technology
- › Most economical operation mode is selected depending on energy prices, outdoor temperature and internal heat load
 - › Optimisation of both technologies



- Ground to water technology:** extracting heat from the ground
- › Ideal for climates where the average winter ambient temperature drops below 3°C
 - › High seasonal efficiency thanks to stable underground temperatures



- Gas condensing technology:**
- › Low costs for **both** heating and hot water thanks to new dual heat exchanger
 - › Easy installation in minimum space by using our optional pre-assembled B-pack which contains all the components for the functional installation in one module and fits behind the boiler



Optimal comfort ... all combined into one system

- › Heating
- › Domestic hot water with optional solar support
- › Cooling
- › Easy control

A solution for any application

- › New build
- › Low energy houses
- › Renovation of complete heating system
- › Renovation without changing radiators/piping
- › Bivalent solution: combination of current heating system with Daikin heating system

Combinable with all kinds of heat emitters

Depending on the needs of your customer, you can select a system combinable with

- › Under floor heating
- › Heat pump convectors
- › Low temperature radiators
- › High temperature radiators (up to 80°C)

Solutions for domestic hot water only

Air to water technology: extracting heat from the outside air to heat up the water.

- › Perfect solution when replacing an electric domestic hot water tank
- › Ideal to combine with a drain-back or pressurised solar system to optimise energy savings
- › Water temperatures of up to 55°C with heat pump operation only

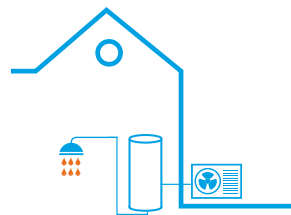

Heating





EHBH(X)-CB



EGSQH-A9W







EKOMB(G)-A(H)





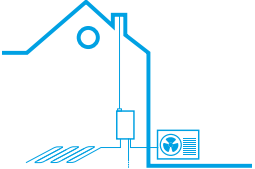



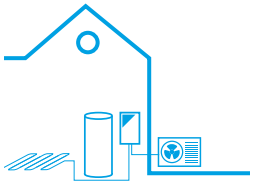

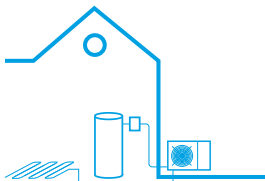
EKHDRD-ADV1/Y1

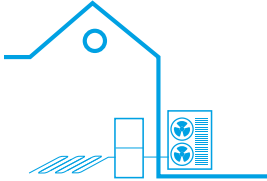
Products overview

Solutions for heating and domestic hot water

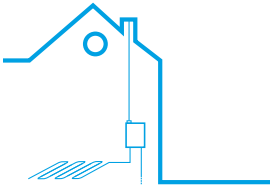
Solutions	Hybrid technology	Ground-to-water technology	
	Daikin Altherma hybrid heat pump	Daikin Altherma ground source heat pump	Daikin Altherma low temperature split
Different technologies	 	 	 
Energy label	<ul style="list-style-type: none"> › heating: up to A⁺⁺ › hot water: A 	<ul style="list-style-type: none"> › heating: A⁺⁺ › hot water: A 	<ul style="list-style-type: none"> › heating: A⁺ › hot water: up to A⁺⁺
Applications	<ul style="list-style-type: none"> › Ideal for replacement of a gas boiler 	<ul style="list-style-type: none"> › Suitable for new houses and for renovations 	<ul style="list-style-type: none"> › Ideal for new houses, low energy houses or together with an existing boiler (bivalent)
Functionalities	<ul style="list-style-type: none"> › Space heating › Domestic hot water › Cooling › Solar connection for hot water production 	<ul style="list-style-type: none"> › Space heating › Domestic hot water 	<ul style="list-style-type: none"> › Space heating › Domestic hot water › Cooling › Solar connection for hot water production
Installation	<ul style="list-style-type: none"> › 1 indoor unit + 1 gas condensing boiler › 1 outdoor unit 	<ul style="list-style-type: none"> › 1 indoor unit 	<ul style="list-style-type: none"> › 1 indoor unit › 1 outdoor unit
Different emitters	<ul style="list-style-type: none"> › Under floor heating › Low and high temperature radiators 	<ul style="list-style-type: none"> › Under floor heating › Fan coil units › Heat pump convactor › Low and high temperature radiators 	<ul style="list-style-type: none"> › Under floor heating › Low temperature radiators › Fan coil units › Heat pump convactor

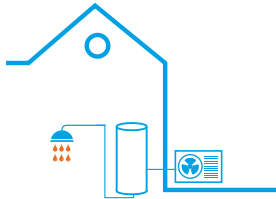
Solutions for heating and domestic hot water				Solution for domestic hot water only
Air-to-water technology			Combustion	
Daikin Altherma low temperature monobloc	Daikin Altherma high temperature split	Daikin Altherma Flex Type	Gas condensing boiler	Domestic hot water heat pump
 	 	 	 	 
	<ul style="list-style-type: none"> › heating: A⁺ › hot water: B 	<ul style="list-style-type: none"> › heating: A⁺ › hot water: A 	<ul style="list-style-type: none"> › heating: A › hot water: A 	<ul style="list-style-type: none"> › hot water: A
	<ul style="list-style-type: none"> › Ideal for replacement of a traditional boiler 	<ul style="list-style-type: none"> › Ideal for large hot water and heating requirements in <ul style="list-style-type: none"> › Apartments › Collective housing › Hotels › Fitness › Spa › Schools › Hospitals › Libraries 	<ul style="list-style-type: none"> › Ideal for replacement of an existing gas boiler 	<ul style="list-style-type: none"> › Ideal for replacement of an electric domestic hot water tank
	<ul style="list-style-type: none"> › Space heating › Domestic hot water › Solar connection for hot water production 	<ul style="list-style-type: none"> › Space heating › Domestic hot water › Cooling (Heat recovery) 	<ul style="list-style-type: none"> › Space heating › Domestic hot water 	<ul style="list-style-type: none"> › Domestic hot water › Solar connection for hot water production
› 1 outdoor unit	<ul style="list-style-type: none"> › 1 indoor unit › 1 outdoor unit 	<ul style="list-style-type: none"> › Several indoor units › 1 or more outdoor units 	› 1 indoor unit	<ul style="list-style-type: none"> › 1 indoor unit › 1 outdoor unit
	<ul style="list-style-type: none"> › High temperature radiators 	<ul style="list-style-type: none"> › Under floor heating › Low temperature radiators › Fan coil units › Heat pump convector 	<ul style="list-style-type: none"> › Under floor heating › Radiators 	<ul style="list-style-type: none"> › Tap water

Combination tables

Daikin Altherma hybrid heat pump

Outdoor		Indoor			
		Heat pump module			Gas condensing boiler
		EHYHBH-AV32 heating only		EHYHBX-AV3 heat pump	EHYKOMB-AA2 ⁽¹⁾ EHYKOMB-AA3 ⁽²⁾
		05	08	08	33
EVLQ-CV3	05	x			x
	08		x	x	x

(1) applicable for Germany, Belgium, France, Italy, United Kingdom, Spain, Netherlands, Ireland, Switzerland, Malta

(2) Applicable for Bulgaria, Bosnia Herzegovina, Croatia, Hungary, Slovakia, Slovenia, Portugal, Greece, Cyprus, Poland, Turkey, Lithuania, Latvia

Daikin Altherma low temperature split

Indoor		Outdoor						Domestic hot water tank-optional						
		Range	Down to -20°C outdoor temp.			ERHQ-BV3 ERHQ-BW1	ERHQ-BV3 ERHQ-BW1	ERHQ-BV3 ERHQ-BW1	EKHWP-B		EKHWP-PB		EKHWS-B	EKHWE-A
			ERLQ-CV3	ERLQ-CV3	ERLQ-CV3	ERLQ-CV3 ERLQ-CW1	ERLQ-CV3 ERLQ-CW1	ERLQ-CV3 ERLQ-CW1	300	500	300	500	150-200-300	150-200-300
Wall mounted	EHBH-CB	04	heating only			—			hot water + drain-back solar		hot water + pressurised solar	hot water + pressurised solar	hot water	
		08	heating only			—			hot water + drain-back solar		hot water + pressurised solar	hot water + pressurised solar		
		11	—			heating only			—	hot water + drain-back solar	—	hot water + pressurised solar		
		16	—			heating only			—	hot water + drain-back solar	—	hot water + pressurised solar		
	EHBX-CB	04	heating & cooling			—			hot water + drain-back solar	hot water + drain-back solar	hot water + pressurised solar	hot water + pressurised solar		
		08	heating & cooling			—			hot water + drain-back solar	hot water + drain-back solar	hot water + pressurised solar	hot water + pressurised solar		
		11	—			heating & cooling			—	hot water + drain-back solar	—	hot water + pressurised solar		
		16	—			heating & cooling			—	hot water + drain-back solar	—	hot water + pressurised solar		
Floor standing with integrated domestic hot water tank	EHVH-CB	04	heating & hot water			—			hot water + drain-back solar		hot water + pressurised solar	hot water + pressurised solar		
		08	heating & hot water			—			hot water + drain-back solar		hot water + pressurised solar	hot water + pressurised solar		
		11	—			heating & hot water			hot water + drain-back solar		hot water + pressurised solar	hot water + pressurised solar		
		16	—			heating & hot water			hot water + drain-back solar		hot water + pressurised solar	hot water + pressurised solar		
	EHVX-CB	04	heating, cooling & hot water			—			hot water + drain-back solar		hot water + pressurised solar	hot water + pressurised solar		
		08	heating, cooling & hot water			—			hot water + drain-back solar		hot water + pressurised solar	hot water + pressurised solar		
		11	—			heating, cooling & hot water			hot water + drain-back solar		hot water + pressurised solar	hot water + pressurised solar		
		16	—			heating, cooling & hot water			hot water + drain-back solar		hot water + pressurised solar	hot water + pressurised solar		
Floor standing with integrated solar supported domestic hot water tank	EHSX-A	04	heating, cooling & hot water with drain-back solar			—			hot water + drain-back solar		hot water + pressurised solar	hot water + pressurised solar		
		08	heating, cooling & hot water with drain-back solar			—			hot water + drain-back solar		hot water + pressurised solar	hot water + pressurised solar		
		16	—			heating, cooling & hot water with drain-back solar (ERLQ only)			hot water + drain-back solar		hot water + pressurised solar	hot water + pressurised solar		
	EHSB-A bivalent	04	heating, cooling & hot water with pressurised solar			—			hot water + drain-back solar		hot water + pressurised solar	hot water + pressurised solar		
		08	heating, cooling & hot water with pressurised solar			—			hot water + drain-back solar		hot water + pressurised solar	hot water + pressurised solar		
		16	—			heating, cooling & hot water with pressurised solar (ERLQ only)			hot water + drain-back solar		hot water + pressurised solar	hot water + pressurised solar		
	EHSXB-A bivalent	04	heating, cooling & hot water with pressurised solar			—			hot water + drain-back solar		hot water + pressurised solar	hot water + pressurised solar		
		08	heating, cooling & hot water with pressurised solar			—			hot water + drain-back solar		hot water + pressurised solar	hot water + pressurised solar		
16		—			heating, cooling & hot water with pressurised solar (ERLQ only)			hot water + drain-back solar		hot water + pressurised solar	hot water + pressurised solar			

Daikin Altherma low temperature monobloc

		Monobloc			Domestic hot water tank-optional					
Down to -20°C outdoor temp.			EBLQ-BB6V3 EBLQ-BB6W1	EDLQ-BB6V3 EDLQ-BB6W1	EKHWP-B		EKHWP-PB		EKHWS-B	EKHWE-A
Down to -25°C outdoor temp.		E(D/B)LQ-CV3 EK(2)CB	EBHQ-BB6V3 EBHQ-BB6W1	EDHQ-BB6V3 EDHQ-BB6W1	300	500	300	500	150-200-300	150-200-300
	005	Heating only heating & cooling EBLQ	—	—	hot water + drain-back solar		hot water + pressurised solar	hot water + pressurised solar	hot water	
	007		—	—	hot water + drain-back solar	—	hot water + pressurised solar			
	011	—	heating & cooling	heating only						
	014	—								
	016	—								

Daikin Altherma high temperature split

		Outdoor			Domestic hot water tank-optional			
		ERRQ-A	ERRQ-A	ERRQ-A	EKHTS-AC	EKHWP-B	EKHWP-PB	
		ERSQ-A	ERSQ-A	ERSQ-A				
Indoor		Range	011	014	016	200-260	300-500	300-500
Floor standing	EKHBRD-AD	011	heating only			hot water	hot water + drain-back solar	hot water + pressurised solar
		014						
		016						

Daikin Altherma Flex Type

		Outdoor					Domestic hot water tank-optional			
		EMRQ-A	EMRQ-A	EMRQ-A	EMRQ-A	EMRQ-A	EKHTS-AC	EKHWP-B	EKHWP-PB	
		8	10	12	14	16				
Indoor		Range						200-260	300-500	300-500
Floor standing	EKHVMRD-AB	50	heating only					hot water	hot water + drain-back solar	hot water + pressurised solar
		80								
	EKHVMYD-AB	50	heating & cooling							
		80								
	EKHBRD-AD	011	heating only							
		014								
016										

Daikin Altherma hybrid heat pump, the natural combination



Why choose Daikin Altherma hybrid heat pump?

- **Low running costs** for heating and domestic hot water compared to traditional boilers
- Low investment cost
- **Ideal for renovation** applications with 27 kW gas boiler and 5 or 7 kW heat pump
- Easy and fast installation

Low running costs

1. Space heating

Daikin Altherma hybrid heat pump smartly chooses between the heat pump and/or the gas boiler, possibly in simultaneous operation based on

- › energy prices
- › outdoor temperature
- › the internal heat load

always selecting the most economical mode to operate.

2. Domestic hot water: heated using gas condensing technology

- › Efficiency increase of up to 10-15% compared to traditional gas condensing boilers thanks to a special dual heat exchanger:
- › cold tap water flows directly into the heat exchanger
- › optimal and continuous condensing of the flue gases during domestic hot water preparation

Low investment cost

- › No need to replace the existing radiators (up to 80°C) and pipe work
- › Compact dimensions: space needed for the new system is very similar to that of an existing system



Supporting tools

Extranet

- › Experience our new business portal at my.daikin.eu
- › Find information easily
- › Access via mobile or desktop
- › Customise the options so you see only info relevant for you



Software

- › Calculate your energy savings: <http://ecocalc.daikin.eu/>

Ideal for renovation applications

- › All heat loads are covered up to 27 kW

Easy and fast installation: 3 components

- › Heat pump outdoor unit
- › Heat pump indoor unit
- › Gas condensing boiler

Gas condensing boiler

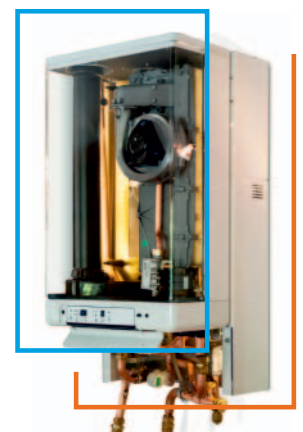

Heat pump indoor unit

Daikin Altherma hybrid heat pump

Hybrid technology combining gas and air to water heat pump for heating and hot water

- › Daikin Altherma hybrid heat pump combines air-to-water heat pump technology with gas condensing technology
- › Depending on outdoor temperature, energy prices and internal heat load, Daikin Altherma hybrid heat pump always selects the most economical mode to operate
- › Low investment cost: no need to replace the existing radiators (up to 80°C) and pipe work
- › Provides sufficient heat in renovation applications as all heat loads are covered up to 32kW
- › Easy and fast installation thanks to the compact dimensions and quick interconnections
- › Outdoor unit extracts heat from the outdoor air, even at -25°C



Efficiency data		EHYHBH/EHYHBX + EVLQ		05AV32 + 05CV3	08AV32 + 08CV3	08AV3 + 08CV3	
Heating capacity	Nom.		kW	4.40 (1) / 4.03 (2)	7.40 (1) / 6.89 (2)	7.40 (3) / 6.89 (4)	
Cooling capacity	Nom.		kW	-	-	6.9 (4) / 5.4 (4)	
Power input	Heating	Nom.	kW	0.87 (1) / 1.13 (2)	1.66 (1) / 2.01 (2)	1.66 (3) / 2.01 (4)	
	Cooling	Nom.	kW	-	-	2.01 (3) / 2.34 (4)	
COP				5.04 (1) / 3.58 (2)	4.45 (1) / 3.42 (2)	4.45 (3) / 3.42 (4)	
EER				-	-	3.42 (3) / 2.29 (4)	
Domestic hot water heating	General	Declared load profile		XL			
	Average climate	Average climate η _{wh} (water heating efficiency) %		96			
Space heating	Average climate water outlet 55°C	General	SCOP	3.28	3.24	3.29	
			η _s (Seasonal space heating efficiency) %	128	127	129	
	Average climate water outlet 35°C	General	Seasonal space heating eff. class	A++			
			η _s (Seasonal space heating efficiency) %	-			
		Seasonal space heating eff. class		-			
Indoor Unit		EHYHBH/EHYHBX		05AV32	08AV32	08AV3	EHYKOMB33AA2/3
Gas	Consumption (G20)	Min-Max	m ³ /h	-			0.78-3.39
	Consumption (G25)	Min-Max	m ³ /h	-			0.90-3.93
	Consumption (G31)	Min-Max	m ³ /h	-			0.30-1.29
	Connection	Diameter	mm	-			15
Central heating	Heat input Q _n (net calorific value)	Min-Max	kW	-			7.6 / 6.2 / 7.6-27 / 22.1 / 27
	Output P _n at 80/60°C	Min-Nom	kW	-			8.2 / 6.7 / 8.2-26.6 / 21.8 / 26.6
	Efficiency	Net calorific value	%	-			98 / 107
	Operation range	Min/Max	°C	-			15/80
Domestic hot water	Output	Min-Nom	kW	-			7.6-32.7
	Water flow	Rate	l/min	-			9.0 / 15.0
	Operation range	Min/Max	°C	-			40/65
Supply air	Connection		mm	-			100
	Concentric			-			Yes
Flue gas	Connection		mm	-			60
Casing	Colour			White			White - RAL9010
	Material			Precoated sheet metal			Precoated sheet metal
Dimensions	Unit	HeightxWidthxDepth	mm	902x450x164			820x-x490x270
Weight	Unit		kg	30	31.2		36
Power supply	Phase/Frequency/Voltage		Hz/V	-			1~/50/230
Electrical power consumption	Max.		W	-			55
	Standby		W	-			2
Operation range	Heating	Ambient	Min.-Max. °C	-			-
		Water side	Min.-Max. °C	-			-
	Cooling	Ambient	Min.-Max. °CDB	-			-
		Water side	Min.-Max. °C	-			-
Notes							For water circuit central heating, safety valve: refer to EHYHB*
Outdoor Unit		EVLQ		05CV3	08CV3		
Dimensions	Unit	HeightxWidthxDepth	mm	735x832x307			
Weight	Unit		kg	54			
Compressor	Quantity			1			
	Type			Hermetically sealed swing compressor			
Operation range	Heating	Min.-Max.	°CWB	-25~-25			
	Refrigerant	Type		R-410A			
	Charge		kg	1.45	1.60		
			TCO ₂ eq	3	3.3		
	GWP			2,087.5			
	Control			Expansion valve (electronic type)			
Sound power level	Heating	Nom.	dBA	61	62		
Sound pressure level	Heating	Nom.	dBA	48	49		
Power supply	Name/Phase/Frequency/Voltage		Hz/V	V3/1~/50/230			
Current	Recommended fuses		A	20			

(1) Condition: Ta DB/WB 7°C/6°C - LWC 35°C (DT = 5°C) (2) Ta DB/WB 7°C/6°C - LWC 45°C (DT = 5°C) (3) cooling Ta 35°C - LWE 18°C (DT = 5°C); heating Ta DB/WB 7°C/6°C - LWC 35°C (DT = 5°C) (4) cooling Ta 35°C - LWE 7°C (DT = 5°C); heating Ta DB/WB 7°C/6°C - LWC 45°C (DT = 5°C) (5) Contains fluorinated greenhouse gases



Daikin Altherma ground source heat pump

Why choose Daikin?

The simple answer is that it is more efficient than an on/off ground source heat pump. Thanks to high efficiencies resulting from our **inverter technology**, the Daikin Altherma ground source heat pump provides a **leading edge performance**.

Highest seasonal efficiency thanks to our inverter heat pump technology

The Daikin inverter heat pump technology has been shown to provide an increase in seasonal efficiency of up to 20% when compared to traditional on/off ground source heat pumps. Higher brine temperatures during continuous compressor operation, in partial load conditions. Less back up heater operation thanks to the boosting of the inverter compressor frequency.

Quick and easy installation including a domestic hot water tank

Installation time is reduced up to 5 hours thanks to the compact designed unit that includes both the space heating and the brine expansion vessel.



Flexibility covering multiple house types

Providing a solution which can cover heat loads from 3-12 kW means replacement of a 6 to 12 kW range is possible with one single unit. This is not only a flexible solution but also space saving.

No affected surroundings

Very limited outdoor space is required, except for the necessary space to prepare the excavation works.

Supporting tools

Extranet

- › Experience our new business portal at my.daikin.eu
- › Find information easily
- › Access via mobile or desktop
- › Customise the options so you see only info relevant for you
www.daikineurope.com/groundsource

Internet

Visit the website:
www.daikineurope.com/groundsource

Daikin Altherma ground source heat pump

Ground source heat pump for heating & hot water

- › Ground source heat pump technology uses stable geothermal energy, unaffected by the outside temperature
- › Highest seasonal efficiency thanks to our inverter heat pump technology
- › Quick and easy installation thanks to factory-fitted piping on top of the unit and reduced overall weight
- › Integrated indoor unit: all-in-one floor standing unit including the domestic hot water tank
- › User interface with thermostat function for higher comfort, quick commissioning, easy servicing and energy management to control energy consumption and costs



Indoor Unit		EGSQH		10S18A9W		
Heating capacity	Min.	kW		3.11 (1) / 2.47 (2)		
	Nom.	kW		10.20 (1) / 9.29 (2)		
	Max.	kW		13.00 (1) / 11.90 (2)		
Power input	Nom.	kW		2.34 (1) / 2.82 (2)		
COP				4.35 (1) / 3.29 (2)		
Casing	Colour			White		
	Material			Precoated sheet metal		
Dimensions	Unit	Height/Width/Depth	mm	1,732/600/728		
Weight	Unit			210		
Tank	Water volume			180		
	Insulation	Heat loss	kWh/24h	1.4		
	Corrosion protection				Anode	
	Operation range	Domestic hot water	Water side Max (booster heater)	-		
Refrigerant	Type			R-410A		
	Charge			1.8		
				3.8		
	Control			Electronic expansion valve		
GWP			2,087.5			
Sound power level	Nom.	dBA		46		
Sound pressure level	Nom.	dBA		32		
Power supply	Name/Phase/Frequency/Voltage	Hz/V		9W/3~/50/400		
Current	Recommended fuses	A		25		
Domestic hot water heating	General	Declared load profile		L		
	Average climate	η_{wh} (water heating efficiency)	%	93.1		
	Water heating energy efficiency class				A	
Space heating	Average climate water outlet 55°C	General	η_s (Seasonal space heating efficiency)	%	144	
			Seasonal space heating eff. class	A++		
	Average climate water outlet 35°C	General	η_s (Seasonal space heating efficiency)	%	202	
			Seasonal space heating eff. class	A++		

(1) EWB/LWB 0°C/-3°C - LWC 35°C (DT=5°C) (2) EWB/LWB 0°C/-3°C - LWC 45°C (DT=5°C)

Daikin Altherma low temperature The natural choice



Why choose Daikin Altherma low temperature?

Daikin Altherma low temperature offers a wide range to adapt to your customer's needs.

- Ideal for **new builds**
- Heating, domestic hot water and cooling with optional solar support
- Capacities from 4 to 16 kW
- Combinable with **under floor heating**, heat pump convectors and low temperature radiators
- Easy control
- **Flexible solutions:** split floor standing, split wall mounted, monobloc

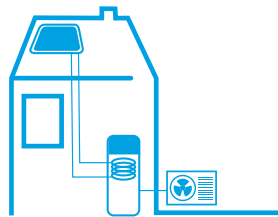

Daikin Altherma low temperature split

- › Best seasonal efficiencies providing the highest savings on running costs
- › Perfect fit for new builds, as well as for low-energy houses

Floor-standing unit with integrated domestic hot water tank

Compact and yet 100% comfort guaranteed

- › All components and connections factory-mounted
- › Very small installation footprint required
- › Minimum electrical input with constantly available hot water
- › Bi-zone option: two temperature zones automatically regulated by the same indoor unit

Integrated solar unit and domestic hot water tank

Maximising renewable energy with top comfort for hot water preparation

- › Solar support for domestic hot water
- › Lightweight plastic tank
- › Bivalent option: can be combined with a secondary heat source
- › App control available

Wall mounted unit

High flexibility for installation and domestic hot water connection

- › Compact unit with small installation space: almost no side clearance required
- › Can be combined with a separate domestic hot water tank of up to 500 litres, with or without solar support

Monobloc outdoor unit

Ideal when indoor space is limited

- › Compact monobloc for space heating & cooling with optional domestic hot water
- › Fuss-free installation: only water and electricity connections are required
- › Reliable operation down to -25°C (outside) thanks to effective frost-protection features



Case Study

Efficient partial-load operation is especially important for the temperature range where the highest heat output is required. Typically, 80% of the total heat output is required in an outdoor temperature range of -2°C to 10°C . Achieving high efficiencies in this temperature range, contributes strongly to high seasonal efficiencies.

Typical application:

- › Location: Paris
- › Design temperature: -7°C
- › Heat load: 7kW
- › Heating off temperature: 16°C

- › Largest part of heat output delivered at optimal efficiencies
- › Less on/off operation when heat load becomes lower than the minimum capacity the heat pump can deliver, optimising efficiency and comfort
- › Modulating range doubled vs standard air-to-water heat pumps
- › New range delivers around 1kW additional in full-load condition at -7°C (+25%)

Standard heat pump

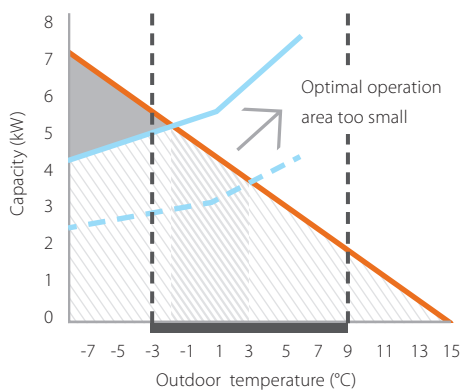

Daikin Altherma

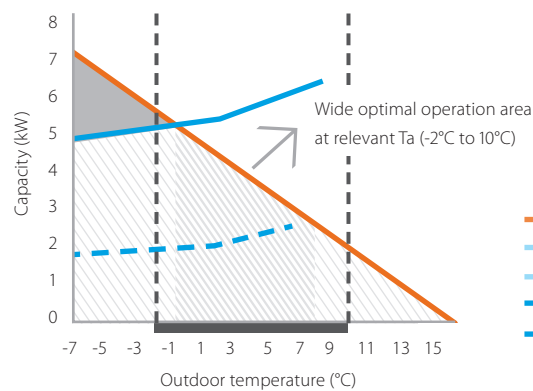

Resulting in
the best possible
efficiencies

- heat load line
- standard heat pump max capacity
- - - standard heat pump min capacity
- ERLQ006CAV3 max capacity
- - - ERLQ006CAV3 min capacity



Eco-calculator

Supporting tools

Extranet

- › Experience our new business portal at my.daikin.eu
- › Find information easily
- › Access via mobile or desktop
- › Customise the options so you see only info relevant for you

Internet

- › Find our solutions for different applications on www.daikineurope.com/minisite/daikin_altherma_it/

Literature

- › See all the literature available on www.daikineurope.com/support-and-manuals/catalogues

Software

- › Calculate your energy savings: <http://ecocalc.daikin.eu/>

Daikin Altherma low temperature split



Floor standing air to water heat pump for heating and hot water, ideal for low energy houses

- › Integrated indoor unit: all-in-one floor standing unit including the domestic hot water tank
- › Energy efficient heating only system based on air to water heat pump technology
- › Perfect fit for new built as well as for low energy houses
- › Best seasonal efficiencies, providing the highest savings on running costs
- › Flexible configuration with respect to heat emitters
- › Outdoor unit extracts heat from the outdoor air, even at -25°C

Efficiency data		EHVH + ERLQ		04S18 CB3V + 004 CV3	08S18CB3V / 08S26CB9W + 006CV3	08S18CB3V / 08S26CB9W + 008CV3	11S18CB3V / 11S26CB9W + 011CV3	16S18CB3V / 16S26CB9W + 014CV3	16S18CB3V / 16S26CB9W + 016CV3	11S18CB3V / 11S26CB9W + 011CW1	16S18CB3V / 16S26CB9W + 014CW1	16S18CB3V / 16S26CB9W + 016CW1			
Heating capacity	Nom.			kW	4.40 (1) / 4.03 (2)	6.00 (1) / 5.67 (2)	7.40 (1) / 6.89 (2)	11.2 (1) / 11.0 (2)	14.5 (1) / 13.6 (2)	16.0 (1) / 15.2 (2)	11.2 (1) / 11.0 (2)	14.5 (1) / 13.6 (2)	16.0 (1) / 15.2 (2)		
Power input	Heating	Nom.		kW	0.870 (1) / 1.13 (2)	1.27 (1) / 1.59 (2)	1.66 (1) / 2.01 (2)	2.43 (1) / 3.10 (2)	3.37 (1) / 4.10 (2)	3.76 (1) / 4.66 (2)	3.42 (1) / 4.21 (2)	3.37 (1) / 4.10 (2)	3.76 (1) / 4.66 (2)		
COP					5.04 (1) / 3.58 (2)	4.74 (1) / 3.56 (2)	4.45 (1) / 3.42 (2)	4.60 (1) / 2.75 (2) / 3.55 (3) / 2.10 (4)	4.30 (1) / 2.65 (2) / 3.32 (3) / 2.08 (4)	4.25 (1) / 2.64 (2) / 3.26 (3) / 2.09 (4)	4.60 (1) / 2.75 (2) / 3.55 (3) / 2.10 (4)	4.30 (1) / 2.65 (2) / 3.32 (3) / 2.08 (4)	4.25 (1) / 2.64 (2) / 3.26 (3) / 2.09 (4)		
Domestic hot water heating	General	Declared load profile			L	XL	L	XL	L	XL	L	XL	L	XL	
	Average climate	η_{wh} (water heating efficiency)		%	95.0	86.4	90.0	86.4	90.0	87.4	97.7	87.4	97.7	87.4	97.7
		Water heating energy efficiency class		A											
Space heating	Average climate water outlet 55°C	General	SCOP		3.20	3.22	3.23	3.09	3.16	3.06	3.09	3.16	3.06		
		η_s (Seasonal space heating efficiency)		%	125	126		120	123	119	120	123	119		
			Seasonal space heating eff. class		A++				A+						
	Average climate water outlet 35°C	General	SCOP		4.52	4.29	4.34	3.98	3.90	3.80	3.98	3.90	3.80		
		η_s (Seasonal space heating efficiency)		%	178	169	171	156	153	149	156	153	149		
		Seasonal space heating eff. class		A++				A+		A++		A+			

Indoor Unit		EHVH		04S18 CB3V	08S18CB3V / 08S26CB9W	08S18CB3V / 08S26CB9W	11S18CB3V / 11S26CB9W	16S18CB3V / 16S26CB9W	16S18CB3V / 16S26CB9W	11S18CB3V / 11S26CB9W	16S18CB3V / 16S26CB9W	16S18CB3V / 16S26CB9W						
Casing	Colour	White																
	Material	Precoated sheet metal																
Dimensions	Unit	HeightxWidthxDepth		mm														
		1,732x600x728																
Weight	Unit	kg																
		116	117	127	117	127	117	126	118	128	118	128	117	126	118	128	118	128
Tank	Water volume	l																
	Maximum water temperature		°C															
	Maximum water pressure		bar															
	Corrosion protection		Anode															
Operation range	Heating	Water side Min.~Max.		°C				15~55				15~55						
	Domestic hot water	Water side Min.~Max.		°C				25~60				25~60 / 60						
Refrigerant	Charge	TCO ₂ eq																
	GWP																	
		2,087.5																
Sound power level	Nom.	dBA																
		42				44				42				44				
Sound pressure level	Nom.	dBA																
		28				30				28				30				

Outdoor Unit		ERLQ		004CV3	006CV3	008CV3	011CV3	014CV3	016CV3	011CW1	014CW1	016CW1								
Dimensions	Unit	HeightxWidthxDepth		mm				1,345x900x320												
Weight	Unit	kg																		
		54	56		113			114												
Compressor	Quantity	1																		
	Type	Hermetically sealed swing compressor				Hermetically sealed scroll compressor														
Operation range	Cooling	Min.~Max.		°CDB				10.0~43.0					10.0~46.0							
	Domestic hot water	Min.~Max.		°CDB				-25~35					-20~35							
Refrigerant	Type	R-410A																		
	GWP	2,087.5																		
	Charge	TCO ₂ eq																		
			3.1	3.3		7.1			3.4											
		1.5		1.6		Expansion valve (electronic type)														
Sound power level	Heating	Nom.		dBA				61					62							
	Cooling	Nom.		dBA				63					64				66			
Sound pressure level	Heating	Nom.		dBA				48					49				50			
	Cooling	Nom.		dBA				48					49				50			
Power supply	Name/Phase/Frequency/Voltage			Hz/V		V3/1~/50/230					W1/3N~/50/400									
Current	Recommended fuses			A		16					20				40					

(1) Cooling Ta 35°C - LWE 18°C (DT = 5°C); heating Ta DB/WB 7°C/6°C - LWC 35°C (DT = 5°C) (2) cooling Ta 35°C - LWE 7°C (DT = 5°C); heating Ta DB/WB 7°C/6°C - LWC 45°C (DT = 5°C) (3) Ta DB -7°C (RH85%) - LWC 35°C (4) Ta DB -7°C (RH85%) - LWC 45°C (5) Contains fluorinated greenhouse gases

Daikin Altherma low temperature split



Efficiency data			EHVH + ERHQ		11S18CB3V / 11S26CB9W + 011BV3		16S18CB3V / 16S26CB9W + 014BV3		16S18CB3V / 16S26CB9W + 016BV3		11S18CB3V / 11S26CB9W + 011BW1		16S18CB3V / 16S26CB9W + 014BW1		16S18CB3V / 16S26CB9W + 016BW1					
Heating capacity	Nom.		kW		11.2 (1) / 10.3 (2)		14.0 (1) / 13.1 (2)		16.0 (1) / 15.2 (2)		11.3 (1) / 11.0 (2)		14.5 (1) / 13.6 (2)		16.1 (1) / 15.1 (2)					
Power input	Heating	Nom.	kW		2.55 (1) / 3.17 (2)		3.26 (1) / 4.04 (2)		3.92 (1) / 4.75 (2)		2.63 (1) / 3.24 (2)		3.42 (1) / 4.21 (2)		3.82 (1) / 4.69 (2)					
COP					4.39 (1) / 3.25 (2)		4.29 (1) / 3.24 (2)		4.08 (1) / 3.20 (2)		4.30 (1) / 3.39 (2)		4.24 (1) / 3.22 (2)		4.20 (1) / 3.22 (2)					
Domestic hot water heating	General	Declared load profile		L	XL	L	XL	L	XL	L	XL	L	XL	L	XL					
	Average climate	η_{wh} (water heating efficiency)	%	90.5	95.3	90.5	95.3	90.5	95.3	84.3	87.3	84.3	87.3	84.3	87.3					
Space heating	Average climate water outlet 55°C	General	SCOP	2.86		2.82		2.92		2.90		2.80		2.96						
		General	η_s (Seasonal space heating efficiency)	%	112	110	114	113	109	115										
	Average climate water outlet 35°C	General	Seasonal space heating eff. class	A																
		General	SCOP	2.99		3.23		3.29		3.08		3.34		3.33						
		General	η_s (Seasonal space heating efficiency)	%	117	126	129	120	131	130										
		General	Seasonal space heating eff. class	A		A+		A		A+										
Indoor Unit			EHVH		11S18CB3V / 11S26CB9W		16S18CB3V / 16S26CB9W		16S18CB3V / 16S26CB9W		11S18CB3V / 11S26CB9W		16S18CB3V / 16S26CB9W		16S18CB3V / 16S26CB9W					
Casing	Colour	White																		
	Material	Precoated sheet metal																		
Dimensions	Unit	HeightxWidthxDepth	mm																	
Weight	Unit	kg																		
Tank	Water volume	l		117	126	118	128	118	128	117	126	118	128	118	128					
	Maximum water temperature	°C		65																
	Maximum water pressure	bar		10																
	Corrosion protection			Anode																
Operation range	Heating	Water side	Min.~Max.	°C																
	Domestic hot water	Water side	Min.~Max.	°C																
Refrigerant	Charge	TCO ₂ eq		-																
	GWP			2,087.5																
Sound power level	Nom.	dBA		42				44				42				44				
Sound pressure level	Nom.	dBA		28				30				28				30				
Outdoor Unit			ERHQ		011BV3		014BV3		016BV3		011BW1		014BW1		016BW1					
Dimensions	Unit	HeightxWidthxDepth	mm																	
Weight	Unit	kg																		
Compressor	Quantity	1																		
	Type	Hermetically sealed scroll compressor																		
Operation range	Cooling	Min.~Max.	°CDB																	
	Domestic hot water	Min.~Max.	°CDB																	
Refrigerant	Type	R-410A																		
	Charge	kg	2.7				3.0													
		TCO ₂ eq	5.6				6.3													
	GWP	2,087.5																		
Sound power level	Heating	Nom.	dBA		64				66				64				66			
	Cooling	Nom.	dBA		64				66				64				66			
Sound pressure level	Heating	Nom.	dBA		49				51				50				52			
	Cooling	Nom.	dBA		50				52				54				52			
Power supply	Name/Phase/Frequency/Voltage	Hz/V		V3/1~/50/230								W1/3N~/50/400								
Current	Recommended fuses	A		32								20								

(1) Cooling Ta 35°C - LWE 18°C (DT = 5°C); heating Ta DB/WB 7°C/6°C - LWC 35°C (DT = 5°C) (2) cooling Ta 35°C - LWE 7°C (DT = 5°C); heating Ta DB/WB 7°C/6°C - LWC 45°C (DT = 5°C) (3) Contains fluorinated greenhouse gases

Daikin Altherma low temperature split

Floor standing air to water heat pump for **heating, cooling and hot water**; ideal for low energy houses

- › Integrated indoor unit: all-in-one floor standing unit including the domestic hot water tank
- › Energy efficient heating and cooling system based on air to water heat pump technology
- › Perfect fit for new built as well as for low energy houses
- › Best seasonal efficiencies, providing the highest savings on running costs
- › Flexible configuration with respect to heat emitters
- › Outdoor unit extracts heat from the outdoor air, even at -25°C

Efficiency data			EHVX + ERLQ		04S18 CB3V + 004 CV3	08S18CB3V /08S26CB9W +006CV3	08S18CB3V /08S26CB9W +008CV3	11S18CB3V /11S26CB9W +011CV3	16S18CB3V /16S26CB9W +014CV3	16S18CB3V /16S26CB9W +016CV3	11S18CB3V /11S26CB9W +011CW1	16S18CB3V /16S26CB9W +014CW1	16S18CB3V /16S26CB9W +016CW1		
Heating capacity	Nom.				kW	4.40 (1) / 4.03 (2)	6.00 (1) / 5.67 (2)	7.40 (1) / 6.89 (2)	11.2 (1) / 11.0 (2)	14.5 (1) / 13.6 (2)	16.0 (1) / 15.2 (2)	11.2 (1) / 11.0 (2)	14.5 (1) / 13.6 (2)	16.0 (1) / 15.2 (2)	
Cooling capacity	Nom.				kW	4.08 (1) / 4.17 (2)	5.88 (1) / 4.84 (2)	6.20 (1) / 5.36 (2)	12.1 (1) / 11.7 (2)	12.7 (1) / 12.6 (2)	13.8 (1) / 13.1 (2)	12.1 (1) / 11.7 (2)	12.7 (1) / 12.6 (2)	13.8 (1) / 13.1 (2)	
Power input	Heating	Nom.			kW	0.870 (1) / /1.13 (2)	1.27 (1) / 1.59 (2)	1.66 (1) / 2.01 (2)	2.43 (1) / 3.10 (2)	3.37 (1) / 4.10 (2)	3.76 (1) / 4.66 (2)	2.43 (1) / 3.10 (2)	3.37 (1) / 4.10 (2)	3.76 (1) / 4.66 (2)	
	Cooling	Nom.			kW	0.900 (1) / /1.80 (2)	1.51 (1) / 2.07 (2)	1.64 (1) / 2.34 (2)	3.05 (1) / 4.31 (2)	3.21 (1) / 5.08 (2)	3.74 (1) / 5.73 (2)	3.05 (1) / 4.31 (2)	3.21 (1) / 5.08 (2)	3.74 (1) / 5.73 (2)	
COP						5.04 (1) / 3.58 (2)	4.74 (1) / 3.56 (2)	4.45 (1) / 3.42 (2)	4.60 (1) / 2.75 (2) / 3.55 (3) / 2.10 (4)	4.30 (1) / 2.65 (2) / 3.32 (3) / 2.08 (4)	4.25 (1) / 2.64 (2) / 3.26 (3) / 2.09 (4)	4.60 (1) / 2.75 (2) / 3.55 (3) / 2.10 (4)	4.30 (1) / 2.65 (2) / 3.32 (3) / 2.08 (4)	4.25 / 2.64 / 3.26 / 2.09	
EER						4.55 (1) / 2.32 (2)	3.89 (1) / 2.34 (2)	3.79 (1) / 2.29 (2)	3.98 (1) / 2.72 (2)	3.96 (1) / 2.47 (2)	3.69 (1) / 2.29 (2)	3.98 (1) / 2.72 (2)	3.96 (1) / 2.47 (2)	3.69 (1) / 2.29 (2)	
Domestic hot water heating	General Average climate	Declared load profile		r _{wh} (water heating efficiency) %		L XL		L XL		L XL		L XL		L XL	
		Water heating energy efficiency class		%		95.0	86.4	90.0	86.4	90.0	87.4	97.7	87.4	97.7	87.4
Space heating	Average climate water outlet 55°C	General	SCOP			3.20	3.22	3.23	3.09	3.16	3.06	3.09	3.16	3.06	
			η _s (Seasonal space heating efficiency) Seasonal space heating eff. class	%		125	126		120	123	119	120	123	119	
	Average climate water outlet 35°C	General	SCOP			4.52	4.29	4.34	3.98	3.90	3.80	3.98	3.90	3.80	
			η _s (Seasonal space heating efficiency) Seasonal space heating eff. class	%		178	169	171	156	153	149	156	153	149	

Indoor Unit			EHVX		04S18 CB3V /08S26CB9W	08S18CB3V /08S26CB9W	11S18CB3V /11S26CB9W	16S18CB3V /16S26CB9W	16S18CB3V /16S26CB9W	11S18CB3V /11S26CB9W	16S18CB3V /16S26CB9W	16S18CB3V /16S26CB9W
Casing	Colour	White										
	Material	Precoated sheet metal										
Dimensions	Unit	HeightxWidthxDepth	mm									
Weight	Unit	kg										
Tank	Water volume	l										
	Maximum water temperature	°C										
	Maximum water pressure	bar										
	Corrosion protection	Anode										
Operation range	Heating	Water side	Min.~Max.		°C		15~55		15~55			
	Cooling	Water side	Min.~Max.		°C		5~22		5~22			
	Domestic hot water	Water side	Min.~Max.		°C		25~60		25~60 / 60			
Refrigerant	Charge	TCO ₂ eq										
	GWP	2,087.5										
Sound power level	Nom.	dBA		42		44		42		44		
Sound pressure level	Nom.	dBA		28		30		28		30		

Outdoor Unit			ERLQ		004CV3	006CV3	008CV3	011CV3	014CV3	016CV3	011CW1	014CW1	016CW1	
Dimensions	Unit	HeightxWidthxDepth	mm											
Weight	Unit	kg												
Compressor	Quantity	54												
	Type	Hermetically sealed swing compressor												
Operation range	Cooling	Min.~Max.	°CDB		10.0~43.0		10.0~46.0		10.0~46.0					
	Domestic hot water	Min.~Max.	°CDB		-25~35		-20~35		-20~35					
Refrigerant	Type	R-410A												
	GWP	2,087.5												
	Charge	TCO ₂ eq	kg		3.1		3.3		7.1		3.4			
Sound power level	Heating	Nom.	dBA		61		62		64		66		66	
		Nom.	dBA		63		64		66		69		69	
	Cooling	Nom.	dBA		48		49		51		52		52	
		Nom.	dBA		48		49		50		52		54	
Power supply	Name/Phase/Frequency/Voltage	Hz/V												
Current	Recommended fuses	A												

(1) Condition 1: cooling Ta 35°C - LWE 18°C (DT = 5°C); heating Ta DB/WB 7°C/6°C - LWC 35°C (DT = 5°C) (2) Cooling Ta 35°C - LWE 7°C (DT = 5°C); heating Ta DB/WB 7°C/6°C - LWC 45°C (DT = 5°C)
(3) Ta DB -7°C (RH85%) - LWC 35°C (4) Ta DB -7°C (RH85%) - LWC 45°C (5) Contains fluorinated greenhouse gases

Daikin Altherma low temperature split



Efficiency data			EHVX + ERHQ		11S18CB3V / 11S26CB9W + 011BV3		16S18CB3V / 16S26CB9W + 014BV3		16S18CB3V / 16S26CB9W + 016BV3		11S18CB3V / 11S26CB9W + 011BW1		16S18CB3V / 16S26CB9W + 014BW1		16S18CB3V / 16S26CB9W + 016BW1		
Heating capacity	Nom.	kW			11.2 (1) / 10.3 (2)		14.0 (1) / 13.1 (2)		16.0 (1) / 15.2 (2)		11.3 (1) / 11.0 (2)		14.5 (1) / 13.6 (2)		16.1 (1) / 15.1 (2)		
Cooling capacity	Nom.	kW			13.9 (1) / 10.0 (2)		17.3 (1) / 12.5 (2)		17.8 (1) / 13.1 (2)		15.1 (1) / 11.7 (2)		16.1 (1) / 12.6 (2)		16.8 (1) / 13.1 (2)		
Power input	Heating	Nom.			2.55 (1) / 3.17 (2)		3.26 (1) / 4.04 (2)		3.92 (1) / 4.75 (2)		2.63 (1) / 3.24 (2)		3.42 (1) / 4.21 (2)		3.82 (1) / 4.69 (2)		
	Cooling	Nom.			3.86 (1) / 3.69 (2)		5.86 (1) / 5.69 (2)		6.87 (1) / 5.95 (2)		4.53 (1) / 4.31 (2)		5.43 (1) / 5.08 (2)		6.16 (1) / 5.73 (2)		
COP					4.39 (1) / 3.25 (2)		4.29 (1) / 3.24 (2)		4.08 (1) / 3.20 (2)		4.30 (1) / 3.39 (2)		4.24 (1) / 3.22 (2)		4.20 (1) / 3.22 (2)		
EER					3.60 (1) / 2.71 (2)		2.95 (1) / 2.32 (2)		2.59 (1) / 2.20 (2)		3.32 (1) / 2.72 (2)		2.96 (1) / 2.47 (2)		2.72 (1) / 2.29 (2)		
Domestic hot water heating	General Average climate	Declared load profile															
		η_{wh} (water heating efficiency) %	Water heating energy efficiency class		L	XL	L	XL	L	XL	L	XL	L	XL	L	XL	L
				90.5	95.3	90.5	95.3	90.5	95.3	84.3	87.3	84.3	87.3	84.3	87.3	84.3	87.3
				A													
Space heating	Average climate water outlet 55°C	General	SCOP η_s (Seasonal space heating efficiency) %			2.86		2.82		2.92		2.90		2.80		2.96	
				Seasonal space heating eff. class		A+											
Average climate water outlet 35°C	General	SCOP η_s (Seasonal space heating efficiency) %			2.99		3.23		3.29		3.08		3.34		3.33		
			Seasonal space heating eff. class		A		A+		A		A+						
Indoor Unit			EHVX		11S18CB3V / 11S26CB9W		16S18CB3V / 16S26CB9W		16S18CB3V / 16S26CB9W		11S18CB3V / 11S26CB9W		16S18CB3V / 16S26CB9W		16S18CB3V / 16S26CB9W		
Casing	Colour	White															
	Material	Precoated sheet metal															
Dimensions	Unit	HeightxWidthxDepth		mm													
	Unit	1,732x600x728															
Weight	Unit	kg															
	Tank	Water volume	l		180	260	180	260	180	260	180	260	180	260	180	260	180
Operation range	Heating	Water side	Min.~Max.	°C													
	Cooling	Water side	Min.~Max.	°C													
	Domestic hot water	Water side	Min.~Max.	°C													
Refrigerant	Charge	TCO ₂ eq															
	GWP	2,087.5															
Sound power level	Nom.	dBA		42				44				42				44	
Sound pressure level	Nom.	dBA		28				30				28				30	
Outdoor Unit			ERHQ		011BV3		014BV3		016BV3		011BW1		014BW1		016BW1		
Dimensions	Unit	HeightxWidthxDepth		mm													
	Unit	kg															
Compressor	Quantity	1															
	Type	Hermetically sealed scroll compressor															
Operation range	Cooling	Min.~Max.		°CDB													
	Domestic hot water	Min.~Max.		°CDB													
Refrigerant	Type	R-410A															
	Charge	kg		2.7		3.0		3.0		3.0		6.3		6.3			
Sound power level	Heating	Nom.		dBA		64		66		66		64		66			
	Cooling	Nom.		dBA		64		66		69		64		66			
Sound pressure level	Heating	Nom.		dBA		49		51		53		51		52			
	Cooling	Nom.		dBA		50		52		54		50		54			
Power supply	Name/Phase/Frequency/Voltage			Hz/V													
Current	Recommended fuses			A													
				V3/1~/50/230						W1/3N~/50/400							
				32						20							

(1) Cooling Ta 35°C - LWE 18°C (DT = 5°C); heating Ta DB/WB 7°C/6°C - LWC 35°C (DT = 5°C) (2) Cooling Ta 35°C - LWE 7°C (DT = 5°C); heating Ta DB/WB 7°C/6°C - LWC 45°C (DT = 5°C) (3) Contains fluorinated greenhouse gases

Daikin Altherma low temperature split



Optimum efficiency offering full flexibility in heat emitters throughout the house

- › Two different temperature zones can be automatically regulated by the same indoor unit
- › Offers flexibility to the end user to combine different heat emitters e.g. under floor heating and radiators while optimising the efficiency
- › Integrated indoor unit: all-in-one floor standing unit including the domestic hot water tank
- › Energy efficient heating only system based on air to water heat pump technology
- › Outdoor unit extracts heat from the outdoor air, even at -25°C

Efficiency data			EHVZ + ERLQ	04S18CB3V + 004CV3	08S18CB3V + 006CV3	08S18CB3V + 008CV3	16S18CB3V + 011CV3	16S18CB3V + 014CV3	16S18CB3V + 016CV3	16S18CB3V + 011CW1	16S18CB3V + 014CW1	16S18CB3V + 016CW1
Heating capacity	Nom.		kW	4.40 (1) / 4.03 (2)	6.00 (1) / 5.67 (2)	7.40 (1) / 6.89 (2)	11.2 (1) / 11.0 (2)	14.4 (1) / 13.5 (2)	15.9 (1) / 15.1 (2)	11.2 (1) / 11.0 (2)	14.4 (1) / 13.5 (2)	15.9 (1) / 15.1 (2)
Power input	Heating	Nom.	kW	0.870 (1) / 1.13 (2)	1.27 (1) / 1.59 (2)	1.66 (1) / 2.01 (2)	2.43 (1) / 3.10 (2)	3.39 (1) / 4.12 (2)	3.77 (1) / 4.67 (2)	2.43 (1) / 3.10 (2)	3.39 (1) / 4.12 (2)	3.77 (1) / 4.67 (2)
COP				5.04 (1) / 3.58 (2)	4.74 (1) / 3.56 (2)	4.45 (1) / 3.42 (2)	4.60 (1) / 2.75 (2) / 3.55 (3) / 2.10 (4)	4.24 (1) / 2.61 (2) / 3.28 (3) / 2.05 (4)	4.22 (1) / 2.61 (2) / 3.23 (3) / 2.07 (4)	4.60 (1) / 2.75 (2) / 3.55 (3) / 2.10 (4)	4.24 (1) / 2.61 (2) / 3.28 (3) / 2.05 (4)	4.22 (1) / 2.61 (2) / 3.23 (3) / 2.07 (4)
Pump Additional Zone	Nominal ESP unit (*RLQ*°C*)	Heating	kPa	52.3 / 55.4	40.6 / 43.3	28.3 / 32.7	26.2 / 28.3	25.0	25.0	26.2 / 28.3	25.0	25.0
Pump Main Zone	Nominal ESP unit (*RLQ*°C*)	Heating	kPa	48.6 / 51.9	39.5 / 42.3	26.4 / 31.2	18.2 / 20.7	25.0	25.0	18.2 / 20.7	25.0	25.0
Domestic hot water heating	General	Declared load profile		L								
	Average climate	General	η_{wh} (water heating efficiency) %	95.0	86.4	87.4						
Space heating	Average climate water outlet 55°C	General	SCOP	3.20	3.22	3.23	3.09	3.16	3.06	3.09	3.16	3.06
			η_s (Seasonal space heating efficiency) %	125	126		120	123	119	120	123	119
	Average climate water outlet 35°C	General	Seasonal space heating eff. class	A++			A+					
			SCOP	4.52	4.29	4.34	-					
			η_s (Seasonal space heating efficiency) %	178	169	171	-					
			Seasonal space heating eff. class	A++			-					
Indoor Unit			EHVZ	04S18CB3V	08S18CB3V	16S18CB3V						
Casing	Colour	White										
	Material	Precoated sheet metal										
Dimensions	Unit	HeightxWidthxDepth	mm	1,732x600x728								
Weight	Unit		kg	121	122		180			121		
Tank	Water volume		l	180								
	Maximum water temperature		°C	65								
	Maximum water pressure		bar	10								
	Corrosion protection			Anode								
Operation range	Heating	Water side Min.~Max.	°C	15~55			15~55					
	Domestic hot water	Water side Min.~Max.	°C	25~60			25~60 / 60					
Refrigerant	Charge		TCO ₂ eq	-								
	GWP			2,087.5								
Sound power level	Nom.		dBA	42			44					
Sound pressure level	Nom.		dBA	28			30					
Outdoor Unit			ERLQ	004CV3	006CV3	008CV3	011CV3	014CV3	016CV3	011CW1	014CW1	016CW1
Dimensions	Unit	HeightxWidthxDepth	mm	735x832x307								
Weight	Unit		kg	54	56		113			114		
Compressor	Quantity			1								
	Type			Hermetically sealed swing compressor				Hermetically sealed scroll compressor				
Operation range	Cooling	Min.~Max.	°CDB	10.0~43.0			10.0~46.0					
	Domestic hot water	Min.~Max.	°CDB	-25 (2.000~35 (2)			-20 (2.000~35 (2)					
Refrigerant	Type			R-410A								
	GWP			2,087.5								
	Charge		TCO ₂ eq	3.1	3.3		7.1			3.4		
Sound power level	Heating	Nom.	dBA	61	62		64 (3)	66 (3)	66 (3)	64 (3)	66 (3)	66 (3)
		Nom.	dBA	63		64 (4)	66 (4)	69 (4)	64 (4)	66 (4)	69 (4)	
Sound pressure level	Heating	Nom.	dBA	48 (3)		49 (3)	51 (5)		52 (5)	51 (5)		52 (5)
	Cooling	Nom.	dBA	48 (3)	49 (3)	50 (3)	50 (5)	52 (5)	54 (5)	50 (5)	52 (5)	54 (5)
Power supply	Name/Phase/Frequency/Voltage		Hz/V	V3/1~/50/230								
Current	Recommended fuses		A	16			20			40		

(1) cooling Ta 35°C - LWE 18°C (DT = 5°C); heating Ta DB/WB 7°C/6°C - LWC 35°C (DT = 5°C) (2) cooling Ta 35°C - LWE 7°C (DT = 5°C); heating Ta DB/WB 7°C/6°C - LWC 45°C (DT = 5°C)

(3) heating Ta DB -7°C (RH85%) - LWC 35°C (4) heating Ta DB -7°C (RH85%) - LWC 45°C (5) Contains fluorinated greenhouse gases

Daikin Altherma low temperature split



Efficiency data				EHVZ + ERHQ	16S18CB3V + 011BV3	16S18CB3V + 014BV3	16S18CB3V + 016BV3	16S18CB3V + 011BW1	16S18CB3V + 014BW1	16S18CB3V + 016BW1
Heating capacity	Nom.		kW		11.2 (1) / 10.3 (2)	14.0 (1) / 13.1 (2)	16.0 (1) / 15.2 (2)	11.3 (1) / 11.0 (2)	14.5 (1) / 13.6 (2)	16.1 (1) / 15.1 (2)
Power input	Heating	Nom.	kW		2.55 (1) / 3.17 (2)	3.26 (1) / 4.04 (2)	3.92 (1) / 4.75 (2)	2.63 (1) / 3.24 (2)	3.42 (1) / 4.21 (2)	3.82 (1) / 4.69 (2)
COP					4.39 (1) / 3.25 (2)	4.29 (1) / 3.24 (2)	4.08 (1) / 3.20 (2)	4.30 (1) / 3.39 (2)	4.24 (1) / 3.22 (2)	4.20 (1) / 3.22 (2)
Pump Additional Zone	Nominal ESP unit (*RHQ*B*)	Heating	kPa		26.2 / 35.0	25.0		24.8 / 28.3		25.0
Pump Main Zone	Nominal ESP unit (*RHQ*B*)	Heating	kPa		18.2 / 28.8	25.0		16.4 / 20.7		25.0
Domestic hot water heating	General	Declared load profile			L					
	Average climate	η _{wh} (water heating efficiency)		%	90.5					
Space heating	Average climate water outlet 55°C	General	Water heating energy efficiency class		A					
			SCOP	%	2.86	2.82	2.92	2.90	2.80	2.96
Space heating	Average climate water outlet 35°C	General	η _s (Seasonal space heating efficiency)		112	110	114	113	109	115
			Seasonal space heating eff. class		A+					
Space heating	Average climate water outlet 35°C	General	η _s (Seasonal space heating efficiency)		-					
			Seasonal space heating eff. class		-					

Indoor Unit				EHVZ	16S18CB3V
Casing	Colour	White			
	Material	Precoated sheet metal			
Dimensions	Unit	HeightxWidthxDepth	mm	1,732x600x728	
Weight	Unit		kg	121	
Tank	Water volume		l	180	
	Maximum water temperature		°C	65	
	Maximum water pressure		bar	10	
	Corrosion protection			Anode	
Operation range	Heating	Water side Min.~Max.	°C	15~55	
	Domestic hot water	Water side Min.~Max.	°C	25~60 / 60	
Refrigerant	Charge		TCO ₂ eq	-	
	GWP			2,087.5	
Sound power level	Nom.		dBA	44	
Sound pressure level	Nom.		dBA	30	

Outdoor Unit				ERHQ	011BV3	014BV3	016BV3	011BW1	014BW1	016BW1	
Dimensions	Unit	HeightxWidthxDepth	mm	1,170x900x320			1,345x900x320				
Weight	Unit		kg	102			108				
Compressor	Quantity	1									
	Type	Hermetically sealed scroll compressor									
Operation range	Cooling	Min.~Max.	°CDB	10.0~46.0							
	Domestic hot water	Min.~Max.	°CDB	-20~35							
Refrigerant	Type	R-410A									
	Charge		kg	2.7			3.0				
			TCO ₂ eq	5.6			6.3				
	GWP			2,087.5							
Sound power level	Heating	Nom.	dBA	64			66		64		66
		Nom.	dBA	64	66	69	64	66	69		
	Cooling	Nom.	dBA	49			51		53		52
		Nom.	dBA	50	52	54	50	52	54		
Power supply	Name/Phase/Frequency/Voltage		Hz/V	V3/1~/50/230				W1/3N~/50/400			
Current	Recommended fuses		A	32			20				

(1) cooling Ta 35°C - LWE 18°C (DT = 5°C); heating Ta DB/WB 7°C/6°C - LWC 35°C (DT = 5°C) (2) cooling Ta 35°C - LWE 7°C (DT = 5°C); heating Ta DB/WB 7°C/6°C - LWC 45°C (DT = 5°C) (3) heating Ta DB -7°C (RH85%) - LWC 35°C (4) heating Ta DB -7°C (RH85%) - LWC 45°C (4) Contains fluorinated greenhouse gases

Daikin Altherma low temperature split



Floor standing air to water heat pump for heating and hot water with thermal solar support

- > Integrated solar unit, maximising renewable energy and offering top comfort in heating and hot water
- > Solar support of domestic hot water with unpressurised (drain-back) solar system
- > Lightweight plastic tank with exceptional hygienic benefits
- > App control possible for managing heating and hot water operation
- > Outdoor unit extracts heat from the outdoor air, even at -25°C

Efficiency data		EHS + ERLQ		04P30A + 004CV3	08P30A + 006CV3	08P50A + 006CV3	08P30A + 008CV3	08P50A + 008CV3	16P50A + 011CV3	16P50A + 014CV3	16P50A + 016CV3	16P50A + 011CW1	16P50A + 014CW1	16P50A + 016CW1	
Heating capacity	Nom.	kW		4.53(1) / 3.98(2) / 4.26(3) / 3.47(4)	6.06(1) / 5.78(2) / 5.14(3) / 4.60(4)		7.78(1) / 7.27(2) / 5.53(3) / 5.51(4)		11.80(1) / 10.40(2) / 5.95(3) / 7.74(4)	14.81(1) / 13.73(2) / 8.28(3) / 9.57(4)	15.34(1) / 14.86(2) / 8.04(3) / 10.05(4)	11.80(1) / 10.40(2) / 5.95(3) / 7.74(4)	14.81(1) / 13.73(2) / 8.28(3) / 9.57(4)	15.34(1) / 14.86(2) / 8.04(3) / 10.05(4)	
Power input	Heating	Nom.	kW		0.87(1) / 1.04(2) / 1.49(3) / 0.85(4)	1.30(1) / 1.58(2) / 1.88(3) / 1.26(4)		1.69(1) / 2.04(2) / 1.98(3) / 1.56(4)		2.57(1) / 3.13(2) / 2.43(3) / 2.35(4)	3.42(1) / 4.07(2) / 3.17(3) / 2.93(4)	2.57(1) / 3.13(2) / 2.43(3) / 2.35(4)	3.42(1) / 4.07(2) / 3.17(3) / 2.93(4)	4.07(2) / 3.17(3) / 2.93(4)	
COP					5.23(1) / 3.84(2) / 2.85(3) / 4.07(4)	4.65(1) / 3.66(2) / 2.73(3) / 3.64(4)		4.60(1) / 3.57(2) / 2.78(3) / 3.54(4)		4.38(1) / 3.32(2) / 2.45(3) / 3.29(4)	4.27(1) / 3.34(2) / 2.58(3) / 3.22(4)	4.10(1) / 3.22(2) / 2.44(3) / 3.15(4)	4.38(1) / 3.32(2) / 2.45(3) / 3.29(4)	4.27(1) / 3.34(2) / 2.58(3) / 3.22(4)	
Domestic hot water heating	General	Declared load profile			L	XL	L				XL				
	Average climate	η _{wh} (water heating efficiency)		%	103	98	102	90	96		83				
		Water heating energy efficiency class			A										
Space heating	Average climate water outlet 55°C	General	η _s (Seasonal space heating efficiency)		%	130	125	127	125	126	125	126	125	125	
		Seasonal space heating eff. class			A++										
	Average climate water outlet 35°C	General	η _s (Seasonal space heating efficiency)		%	-									
		Seasonal space heating eff. class			-										

Indoor Unit		EHS	04P30A	08P30A	08P50A	08P30A	08P50A	16P50A							
Casing	Colour	Traffic white (RAL9016) / Dark grey (RAL7011)													
	Material	Impact resistant polypropylene													
Dimensions	Unit	HeightxWidthxDepth		mm	1,945x615x595	1,945x790x790	1,945x615x595		1,945x790x790						
Weight	Unit	kg		87	114	87	114	116							
Tank	Water volume	l		300	500	300	500								
	Maximum water temperature	°C		85											
Operation range	Heating	Ambient	Min.~Max.	°C		-25~25		15~55				-25~35			
		Water side	Min.~Max.	°C		-25~35									
	Domestic hot water	Ambient	Min.~Max.	°CDB		25~55		-25~35				25~55			
		Water side	Min.~Max.	°C		R-410A									
Refrigerant	Type	R-410A													
	Charge	kg		1.5	1.6		3.4								
		TCO ₂ eq		-											
	Control	Electronic expansion valve / Inverter													
	GWP	2,087.5													
Sound power level	Nom.	dBA		40											
Sound pressure level	Nom.	dBA		28											

Outdoor Unit		ERLQ	004CV3	006CV3	008CV3	011CV3	014CV3	016CV3	011CW1	014CW1	016CW1	
Dimensions	Unit	HeightxWidthxDepth		mm	735x832x307			1,345x900x320				
Weight	Unit	kg		54	56		113		114			
Compressor	Quantity	1										
	Type	Hermetically sealed swing compressor					Hermetically sealed scroll compressor					
Operation range	Cooling	Min.~Max.	°CDB		10.0~43.0		10.0~46.0					
	Domestic hot water	Min.~Max.	°CDB		-25~35		-20~35					
Refrigerant	Type	R-410A										
	GWP	2,087.5										
	Charge	TCO ₂ eq		3.1	3.3		7.1					
		kg		1.5	1.6		3.4					
	Control	Expansion valve (electronic type)										
Sound power level	Heating	Nom.	dBA		61	62		64	66	64	66	
	Cooling	Nom.	dBA		63		64	66	69	64	66	
Sound pressure level	Heating	Nom.	dBA		48		49		51	52		
	Cooling	Nom.	dBA		48	49		50	52	54	54	
Power supply	Name/Phase/Frequency/Voltage	Hz/V		V3/1~/50/230						W1/3N~/50/400		
Current	Recommended fuses	A		16		20		40		20		

(1) cooling Ta 35°C - LWE 18°C (DT = 5°C); heating Ta DB/WB 7°C/6°C - LWC 35°C (DT = 5°C) (2) cooling Ta 35°C - LWE 7°C (DT = 5°C); heating Ta DB/WB 7°C/6°C - LWC 45°C (DT = 5°C) (3) EW 30°C; LW 35°C; ambient conditions: -7°CDB/-8°CWB (4) EW 30°C; LW 35°C; ambient conditions: 2°CDB/1°CWB (5) Contains fluorinated greenhouse gases

Daikin Altherma low temperature split

Floor standing air to water heat pump for **bivalent** heating and hot water with thermal solar support

> Bivalent system: combinable with a secondary heat source



Efficiency data		EHSB + ERLQ		04P30A + 004CV3	08P30A + 006CV3	08P50A + 006CV3	08P30A + 008CV3	08P50A + 008CV3	16P50A + 011CV3	16P50A + 014CV3	16P50A + 016CV3	16P50A + 011CW1	16P50A + 014CW1	16P50A + 016CW1	
Heating capacity	Nom.	kW		4.53(1)/3.98(2)/4.26(3)/3.47(4)	6.06 (1) / 5.78 (2) / 5.14 (3) / 4.60 (4)	7.78 (1) / 7.27 (2) / 5.53 (3) / 5.51 (4)	1.69 (1) / 2.04 (2) / 1.98 (3) / 1.56 (4)	1.69 (1) / 2.04 (2) / 1.98 (3) / 1.56 (4)	11.80(1)/10.40(2)/5.95(3)/7.74(4)	14.81(1)/13.73(2)/8.28(3)/9.57(4)	15.34(1)/14.86(2)/8.04(3)/10.05(4)	11.80(1)/10.40(2)/5.95(3)/7.74(4)	14.81(1)/13.73(2)/8.28(3)/9.57(4)	15.34(1)/14.86(2)/8.04(3)/10.05(4)	
Power input	Heating	Nom.		kW		1.49(3)/0.85(4)	1.88 (3) / 1.26 (4)	1.98 (3) / 1.56 (4)	2.43(3)/2.35(4)	3.17 (3) / 2.93 (4)	2.93 (4)	2.43(3)/2.35(4)	3.17 (3) / 2.93 (4)	2.93 (4)	
COP						5.23(1)/3.84(2)/2.85(3)/4.07(4)	4.65 (1) / 3.66 (2) / 2.73 (3) / 3.64 (4)	4.60 (1) / 3.57 (2) / 2.78 (3) / 3.54 (4)	4.38(1)/3.32(2)/2.45(3)/3.29(4)	4.27(1)/3.34(2)/2.58(3)/3.22(4)	4.10(1)/3.22(2)/2.44(3)/3.15(4)	4.38(1)/3.32(2)/2.45(3)/3.29(4)	4.27(1)/3.34(2)/2.58(3)/3.22(4)	4.10(1)/3.22(2)/2.44(3)/3.15(4)	
Domestic hot water heating	General	Declared load profile		L		XL	L	XL	XL						
	Average climate	η _{wh} (water heating efficiency)		103	98	108	90	99	84						
Space heating	Average climate water outlet 55°C	General	η _s (Seasonal space heating efficiency)		130	125	127	125	126	125	126	125	126	125	
		Seasonal space heating eff. class		A											
	Average climate water outlet 35°C	General	η _s (Seasonal space heating efficiency)		-										
		Seasonal space heating eff. class		A++											

Indoor Unit		EHSB		04P30A	08P30A	08P50A	08P30A	08P50A	16P50A						
Casing	Colour	Traffic white (RAL9016) / Dark grey (RAL7011)													
	Material	Impact resistant polypropylene													
Dimensions	Unit	HeightxWidthxDepth		1,945x615x595		1,945x790x790		1,945x615x595		1,945x790x790					
Weight	Unit	kg		92		119		92		119		121			
Tank	Water volume	l		300		500		300		500		500			
	Maximum water temperature	°C		85		85		85		85					
Operation range	Heating	Ambient	Min.~Max.		-25~-25						-25~-35				
		Water side	Min.~Max.		15~-55						15~-55				
	Domestic hot water	Ambient	Min.~Max.		-25~-35						-25~-35				
Refrigerant	Type	Min.~Max.		25~-55						25~-55					
		Water side	Min.~Max.		25~-55						25~-55				
	Charge	kg		1.5		1.6		1.6		3.4		3.4			
Control	GWP		Electronic expansion valve / Inverter												
Sound power level	Nom.	dBA		2,087.5											
Sound pressure level	Nom.	dBA		40											
	Nom.	dBA		28											

Outdoor Unit		ERLQ		004CV3	006CV3	008CV3	011CV3	014CV3	016CV3	011CW1	014CW1	016CW1			
Dimensions	Unit	HeightxWidthxDepth		735x832x307				1,345x900x320							
Weight	Unit	kg		54		56		113		114					
Compressor	Quantity	1													
	Type	Hermetically sealed swing compressor						Hermetically sealed scroll compressor							
Operation range	Cooling	Min.~Max.		10.0~43.0				10.0~46.0							
	Domestic hot water	Min.~Max.		-25.000~35				-20.000~35							
Refrigerant	Type	R-410A													
	GWP	2,087.5													
	Charge	kg		3.1		3.3		7.1		7.1					
Control	TCO ₂ eq		1.5		1.6		3.4		3.4						
Sound power level	Heating	Nom.	dBA		61		62		64		66		66		
		Nom.	dBA		63		63		64		66		69		
	Cooling	Nom.	dBA		48		49		51		52		52		
Sound pressure level	Heating	Nom.		48		49		50		50		52		54	
	Cooling	Nom.		48		49		50		50		52		54	
Power supply	Name/Phase/Frequency/Voltage		Hz/V		V3/1~/50/230						W1/3N~/50/400				
Current	Recommended fuses		A		16		20		40		20				

(1) cooling Ta 35°C - LWE 18°C (DT = 5°C); heating Ta DB/WB 7°C/6°C - LWC 35°C (DT = 5°C) (2) cooling Ta 35°C - LWE 7°C (DT = 5°C); heating Ta DB/WB 7°C/6°C - LWC 45°C (DT = 5°C) (3) EW 30°C; LW 35°C; ambient conditions: -7°CDB/-8°CWB (4) EW 30°C; LW 35°C; ambient conditions: 2°CDB/1°CWB (5) Contains fluorinated greenhouse gases

Daikin Altherma low temperature split



Floor standing air to water heat pump for heating, cooling and hot water with thermal solar support

- › Integrated solar unit, maximising renewable energy and offering top comfort in heating, hot water and cooling
- › Solar support of domestic hot water with unpressurised (drain-back) solar system
- › Lightweight plastic tank with exceptional hygienic benefits
- › App control possible for managing heating, hot water and cooling operation
- › Outdoor unit extracts heat from the outdoor air, even at -25°C

Efficiency data			EHSX + ERLQ		04P30A + 004CV3	08P30A + 006CV3	08P50A + 006CV3	08P30A + 008CV3	08P50A + 008CV3	16P50A + 011CV3	16P50A + 014CV3	16P50A + 016CV3	16P50A + 011CW1	16P50A + 014CW1	16P50A + 016CW1				
Heating capacity	Nom.	kW	4.53 (1) / 3.98 (2) / 4.26 (3) / 3.47 (4)		6.06 (1) / 5.78 (2) / 5.14 (3) / 4.60 (4)		7.78 (1) / 7.27 (2) / 5.53 (3) / 5.51 (4)		11.80 (1) / 10.40 (2) / 5.95 (3) / 7.74 (4)		14.81 (1) / 13.73 (2) / 8.28 (3) / 9.57 (4)		15.34 (1) / 14.86 (2) / 8.04 (3) / 10.05 (4)		11.80 (1) / 14.81 (1) / 13.73 (2) / 14.86 (2) / 8.04 (3) / 10.05 (4)				
Cooling capacity	Nom.	kW	4.4 (1) / 4.0 (2)		5.2 (1) / 4.6 (2)				15.1 (1) / 11.7 (2)		16.1 (1) / 12.6 (2)		16.8 (1) / 13.1 (2)		15.1 (1) / 11.7 (2) / 16.1 (1) / 12.6 (2) / 16.8 (1) / 13.1 (2)				
Power input	Heating	Nom.	0.87 (1) / 1.04 (2) / 1.49 (3) / 0.85 (4)		1.30 (1) / 1.58 (2) / 1.88 (3) / 1.26 (4)		1.69 (1) / 2.04 (2) / 1.98 (3) / 1.56 (4)		3.13 (2) / 2.43 (3) / 2.35 (4)		3.42 (1) / 4.07 (2) / 3.17 (3) / 2.93 (4)		3.13 (2) / 2.43 (3) / 2.35 (4)		3.42 (1) / 4.07 (2) / 3.17 (3) / 2.93 (4)				
	Cooling	Nom.	1.05 (1) / 1.41 (2)		1.43 (1) / 1.85 (2)				4.55 (1) / 4.30 (2)		5.44 (1) / 5.10 (2)		6.18 (1) / 5.72 (2)		4.55 (1) / 4.30 (2) / 5.44 (1) / 5.10 (2) / 6.18 (1) / 5.72 (2)				
COP			5.23 (1) / 3.84 (2) / 2.85 (3) / 4.07 (4)		4.65 (1) / 3.66 (2) / 2.73 (3) / 3.64 (4)		4.60 (1) / 3.57 (2) / 2.78 (3) / 3.54 (4)		3.32 (2) / 2.45 (3) / 3.29 (4)		3.34 (2) / 2.58 (3) / 3.22 (4)		3.22 (2) / 2.44 (3) / 3.15 (4)		3.32 (2) / 2.45 (3) / 3.22 (4) / 3.34 (2) / 2.58 (3) / 2.44 (3) / 3.15 (4)				
			4.21 (1) / 2.85 (2)		3.65 (1) / 2.51 (2)				3.32 (1) / 2.72 (2)		2.96 (1) / 2.47 (2)		2.72 (1) / 2.29 (2)		3.32 (1) / 2.96 (1) / 2.72 (1) / 2.96 (1) / 2.72 (2) / 2.47 (2) / 2.29 (2)				
Domestic hot water heating	General	Declared load profile			L	XL	L	XL											
	Average climate	η _{wh} (water heating efficiency) %	103		98	102	90	96	83										
Space heating	Average climate water outlet 55°C	General	η _s (Seasonal space heating efficiency) %	132		126		128		130		127		128		130		127	
		Seasonal space heating eff. class			A++														
	Average climate water outlet 35°C	General	η _s (Seasonal space heating efficiency) %	-															
Seasonal space heating eff. class			-																

Indoor Unit			EHSX		04P30A	08P30A	08P50A	08P30A	08P50A	16P50A						
Casing	Colour	Traffic white (RAL9016) / Dark grey (RAL7011)														
	Material	Impact resistant polypropylene														
Dimensions	Unit	HeightxWidthxDepth	mm		1,945x615x595		1,945x790x790		1,945x615x595		1,945x790x790					
Weight	Unit	kg														
		87		114		87		114		116						
Tank	Water volume	l														
		300		500		300		500		500						
	Maximum water temperature	°C														
		85														
Operation range	Heating	Ambient	Min.~Max.	°C		-25~-25				-25~-35						
		Water side	Min.~Max.	°C		15~55				10~43						
	Cooling	Ambient	Min.~Max.	°CDB		5~22				---						
		Water side	Min.~Max.	°C		-25~-35				25~55						
Domestic hot water	Ambient	Min.~Max.	°CDB		25~55				-							
	Water side	Min.~Max.	°C		-				-							
Refrigerant	Type	R-410A														
	Charge	kg	1.5		1.6		1.6		1.6		3.4					
		TCO ₂ eq	2,087.5		2,087.5		2,087.5		2,087.5		2,087.5					
	Control	Electronic expansion valve / Inverter														
	GWP	2,087.5														
Sound power level	Nom.	dBA		40												
Sound pressure level	Nom.	dBA		28												

Outdoor Unit			ERLQ	004CV3	006CV3	008CV3	011CV3	014CV3	016CV3	011CW1	014CW1	016CW1				
Dimensions	Unit	HeightxWidthxDepth	mm		735x832x307				1,345x900x320							
Weight	Unit	kg														
		54		56		56		113		114		114				
Compressor	Quantity	1														
	Type	Hermetically sealed swing compressor				Hermetically sealed scroll compressor										
Operation range	Cooling	Min.~Max.	°CDB		10.0~43.0				10.0~46.0							
	Domestic hot water	Min.~Max.	°CDB		-25~-35				-20~-35							
Refrigerant	Type	R-410A														
	GWP	2,087.5														
	Charge	TCO ₂ eq	3.1		3.3		3.3		7.1		7.1		3.4			
	kg	1.5		1.6		1.6		1.6		3.4		3.4				
	Control	Expansion valve (electronic type)														
Sound power level	Heating	Nom.	dBA		61		62		64		66		64		66	
	Cooling	Nom.	dBA		63		63		64		66		64		66	
Sound pressure level	Heating	Nom.	dBA		48		49		51		52		51		52	
	Cooling	Nom.	dBA		48		49		50		52		50		54	
Power supply	Name/Phase/Frequency/Voltage	Hz/V		V3/1~/50/230								W1/3N~/50/400				
Current	Recommended fuses	A		16		20		20		40		40		20		

(1) cooling Ta 35°C - LWE 18°C (DT = 5°C); heating Ta DB/WB 7°C/6°C - LWC 35°C (DT = 5°C) (2) cooling Ta 35°C - LWE 7°C (DT = 5°C); heating Ta DB/WB 7°C/6°C - LWC 45°C (DT = 5°C) (3) EW 30°C; LW 35°C; ambient conditions: -7°CDB/-8°CWB (4) EW 30°C; LW 35°C; ambient conditions: 2°CDB/1°CWB (5) Contains fluorinated greenhouse gases

Daikin Altherma low temperature split

Floor standing air to water heat pump for **bivalent** heating, cooling and hot water with thermal solar support

> Bivalent system: combinable with a secondary heat source



Efficiency data			EHSXB + ERLQ	04P30A + 004CV3	08P30A + 006CV3	08P50A + 006CV3	08P30A + 008CV3	08P50A + 008CV3	16P50A + 011CV3	16P50A + 014CV3	16P50A + 016CV3	16P50A + 011CW1	16P50A + 014CW1	16P50A + 016CW1
Heating capacity	Nom.			4.53(1)/3.98(2) /4.26(3)/3.47(4)	6.06 (1) / 5.78 (2) / 5.14 (3) / 4.60 (4)	7.78 (1) / 7.27 (2) / 5.53 (3) / 5.51 (4)			11.80(1)/10.40(2) /5.95(3)/7.74(4)	14.81(1)/13.73(2) /8.28(3)/9.57(4)	15.34(1)/14.86(2) /8.04(3)/10.05(4)	11.80(1)/10.40(2) /5.95(3)/7.74(4)	14.81(1)/13.73(2) /8.28(3)/9.57(4)	15.34(1)/14.86(2) /8.04(3)/10.05(4)
Cooling capacity	Nom.			5.2 (1) / 4.6 (2)		1.30 (1) / 1.58 (2) / 1.88 (3) / 1.26 (4)		1.69 (1) / 2.04 (2) / 1.98 (3) / 1.56 (4)	2.57(1)/3.13(2) /2.43(3)/2.35(4)	3.42 (1) / 4.07 (2) / 3.17 (3) / 2.93 (4)	2.57(1)/3.13(2) /2.43(3)/2.35(4)	3.42 (1) / 4.07 (2) / 3.17 (3) / 2.93 (4)	2.57(1)/3.13(2) /2.43(3)/2.35(4)	3.42 (1) / 4.07 (2) / 3.17 (3) / 2.93 (4)
Power input	Heating	Nom.		0.87(1)/1.04(2) /1.49(3)/0.85(4)	1.30 (1) / 1.58 (2) / 1.88 (3) / 1.26 (4)	1.69 (1) / 2.04 (2) / 1.98 (3) / 1.56 (4)			2.57(1)/3.13(2) /2.43(3)/2.35(4)	3.42 (1) / 4.07 (2) / 3.17 (3) / 2.93 (4)	2.57(1)/3.13(2) /2.43(3)/2.35(4)	3.42 (1) / 4.07 (2) / 3.17 (3) / 2.93 (4)	2.57(1)/3.13(2) /2.43(3)/2.35(4)	3.42 (1) / 4.07 (2) / 3.17 (3) / 2.93 (4)
	Cooling	Nom.		1.05(1)/1.41(2)	1.43 (1) / 1.85 (2)	4.55(1)/4.30(2) /4.38(1)/3.32(2)	4.38(1)/3.32(2) /2.45(3)/3.29(4)	4.60 (1) / 3.57 (2) / 2.78 (3) / 3.54 (4)	4.55(1)/4.30(2) /4.27(1)/3.34(2)	5.44(1)/5.10(2) /4.10(1)/3.22(2)	6.18(1)/5.72(2) /4.38(1)/3.32(2)	4.55(1)/4.30(2) /4.27(1)/3.34(2)	5.44(1)/5.10(2) /4.10(1)/3.22(2)	6.18(1)/5.72(2) /4.27(1)/3.34(2)
COP				5.23(1)/3.84(2) /2.85(3)/4.07(4)	4.65 (1) / 3.66 (2) / 2.73 (3) / 3.64 (4)	4.60 (1) / 3.57 (2) / 2.78 (3) / 3.54 (4)			4.38(1)/3.32(2) /2.45(3)/3.29(4)	4.27(1)/3.34(2) /2.44(3)/3.15(4)	6.18(1)/5.72(2) /4.38(1)/3.32(2)	4.55(1)/4.30(2) /4.27(1)/3.34(2)	5.44(1)/5.10(2) /4.27(1)/3.34(2)	6.18(1)/5.72(2) /4.27(1)/3.34(2)
EER				4.21(1)/2.85(2)	3.65 (1) / 2.51 (2)	3.32(1)/2.72(2) /2.96(1)/2.47(2)			3.32(1)/2.72(2) /2.96(1)/2.47(2)	2.72(1)/2.29(2) /2.72(1)/2.29(2)	3.32(1)/2.72(2) /2.72(1)/2.29(2)	3.32(1)/2.72(2) /2.72(1)/2.29(2)	2.96(1)/2.47(2) /2.96(1)/2.47(2)	2.72(1)/2.29(2) /2.72(1)/2.29(2)
Domestic hot water heating	General Average climate	Declared load profile η _{wh} (water heating efficiency) Water heating energy efficiency class	%	L 103	XL 98	L 108	L 90	XL 99	XL 84					
Space heating	Average climate water outlet 55°C	General	η _s (Seasonal space heating efficiency) Seasonal space heating eff. class	% 132	126	128			A A++	130	127	128	130	127
	Average climate water outlet 35°C	General	η _s (Seasonal space heating efficiency) Seasonal space heating eff. class	% -					-					

Indoor Unit			EHSXB	04P30A	08P30A	08P50A	08P30A	08P50A	16P50A						
Casing	Colour		Traffic white (RAL9016) / Dark grey (RAL7011)												
	Material		Impact resistant polypropylene												
Dimensions	Unit	HeightxWidthxDepth	mm												
	Unit		1,945x615x595	1,945x790x790	1,945x615x595	92	119	92	119	1,945x790x790					
Weight	Unit		kg												
	Unit		300	500	300	300	500	300	500	500					
Tank	Water volume		l												
	Water volume		300												
	Maximum water temperature		°C												
	Maximum water temperature		85												
Operation range	Heating	Ambient Min.-Max.	°C												
	Heating	Water side Min.-Max.	°C												
	Heating	Ambient Min.-Max.	°CDB												
	Heating	Water side Min.-Max.	°C												
	Cooling	Ambient Min.-Max.	°CDB												
	Cooling	Water side Min.-Max.	°C												
	Domestic hot water	Ambient Min.-Max.	°CDB												
	Domestic hot water	Water side Min.-Max.	°C												
Refrigerant	Type		R-410A												
	Charge		kg												
	Charge		1.5	1.6	1.6	1.5	1.6	1.5	1.6	3.4					
	Control		TCO ₂ eq												
	Control		-												
	GWP		Electronic expansion valve / Inverter												
	GWP		2,087.5												
Sound power level	Nom.		dBA												
	Nom.		40												
Sound pressure level	Nom.		dBA												
	Nom.		28												

Outdoor Unit			ERLQ	004CV3	006CV3	008CV3	011CV3	014CV3	016CV3	011CW1	014CW1	016CW1	
Dimensions	Unit	HeightxWidthxDepth	mm										
	Unit		54	735x832x307			1,345x900x320						
Weight	Unit		kg										
	Unit		54	56			113						
Compressor	Quantity		1										
	Type		Hermetically sealed swing compressor										
	Type		Hermetically sealed scroll compressor										
Operation range	Cooling	Min.-Max.	°CDB										
	Cooling	Domestic hot water	°CDB										
	Cooling	Min.-Max.	°CDB										
	Domestic hot water	Min.-Max.	°CDB										
Refrigerant	Type		R-410A										
	GWP		2,087.5										
	Charge		kg										
	Charge		3.1	3.3	3.3	3.1	3.3	3.1	3.3	7.1			
	Control		TCO ₂ eq										
	Control		1.5										
	Control		1.6										
	Control		3.4										
	Control		Expansion valve (electronic type)										
Sound power level	Heating	Nom.	dBA										
	Heating	Nom.	61										
	Cooling	Nom.	dBA										
	Cooling	Nom.	63										
Sound pressure level	Heating	Nom.	dBA										
	Heating	Nom.	48										
	Cooling	Nom.	dBA										
	Cooling	Nom.	48	49	49	50	50	52	54	50	52	54	
Power supply	Name/Phase/Frequency/Voltage		Hz/V										
	Name/Phase/Frequency/Voltage		V3/1~/50/230										
Current	Recommended fuses		A										
	Recommended fuses		16										
	Recommended fuses		20										
	Recommended fuses		40										
	Recommended fuses		W1/3N~/50/400										
	Recommended fuses		20										

(1) cooling Ta 35°C - LWE 18°C (DT = 5°C); heating Ta DB/WB 7°C/6°C - LWC 35°C (DT = 5°C) (2) cooling Ta 35°C - LWE 7°C (DT = 5°C); heating Ta DB/WB 7°C/6°C - LWC 45°C (DT = 5°C) (3) EW 30°C; LW 35°C; ambient conditions: -7°CDB/-8°CWB (4) EW 30°C; LW 35°C; ambient conditions: 2°CDB/1°CWB (5) Contains fluorinated greenhouse gases

Daikin Altherma low temperature split



Wall mounted **heating only** air to water heat pump ideal for low energy houses

- > Energy efficient heating only system based on air to water heat pump technology
- > Perfect fit for new built as well as for low energy houses
- > Best seasonal efficiencies, providing the highest savings on running costs
- > Flexible configuration with respect to heat emitters
- > Possible to combine with domestic hot water
- > Outdoor unit extracts heat from the outdoor air, even at -25°C

Efficiency data		EHBH + ERLQ		04CB3V + 004CV3	08CB3V/9W + 006CV3	08CB3V/9W + 008CV3	11CB3V/9W + 011CV3	16CB3V/9W + 014CV3	16CB3V/9W + 016CV3	11CB3V/9W + 011CW1	16CB3V/9W + 014CW1	16CB3V/9W + 016CW1
Heating capacity	Nom.	kW		4.40 (1) / 4.03 (2)	6.00 (1) / 5.67 (2)	7.40 (1) / 6.89 (2)	11.2 (1) / 11.0 (2)	14.5 (1) / 13.6 (2)	16.0 (1) / 15.2 (2)	11.2 (1) / 11.0 (2)	14.5 (1) / 13.6 (2)	16.0 (1) / 15.2 (2)
Power input	Heating	Nom.		0.870 (1) / 1.13 (2)	1.27 (1) / 1.59 (2)	1.66 (1) / 2.01 (2)	2.43 (1) / 3.10 (2)	3.37 (1) / 4.10 (2)	3.76 (1) / 4.66 (2)	3.42 (1) / 4.21 (2)	3.37 (1) / 4.10 (2)	3.76 (1) / 4.66 (2)
COP				5.04 (1) / 3.58 (2)	4.74 (1) / 3.56 (2)	4.45 (1) / 3.42 (2)	4.60 (1) / 3.55 (3) / 2.10 (4)	4.30 (1) / 3.32 (3) / 2.08 (4)	4.25 (1) / 3.26 (3) / 2.09 (4)	4.60 (1) / 3.55 (3) / 2.10 (4)	4.30 (1) / 3.32 (3) / 2.08 (4)	4.25 (1) / 3.26 (3) / 2.09 (4)
Domestic hot water heating	General	Declared load profile										
	Average climate	η _{wh} (water heating efficiency) %										
		Water heating energy efficiency class										
Space heating	Average climate water outlet 55°C	General	SCOP	3.20	3.22	3.23	3.09	3.16	3.06	3.09	3.16	3.06
			η _s (Seasonal space heating efficiency) %	125	126		120	123	119	120	123	119
			Seasonal space heating eff. class		A++			A+				
	Average climate water outlet 35°C	General	SCOP	4.52	4.29	4.34	3.98	3.90	3.80	3.98	3.90	3.80
η _s (Seasonal space heating efficiency) %			178	169	171	156	153	149	156	153	149	
		Seasonal space heating eff. class		A++				A+		A++		A+

Indoor Unit		EHBH		04CB3V	08CB3V/9W	08CB3V/9W	11CB3V/9W	16CB3V/9W	16CB3V/9W	11CB3V/9W	16CB3V/9W	16CB3V/9W				
Casing	Colour	White														
	Material	Precoated sheet metal														
Dimensions	Unit	HeightxWidthxDp		mm												
		890x480x344														
Weight	Unit	kg														
		41	43	45	43	45	43	44	45	44	45	43	44	45	44	45
Operation range	Heating	Water side Min.~Max.		°C				15~55					15~55			
	Domestic hot water	Water side Min.~Max.		°C				25~80					25~80			
Refrigerant	Charge	TCO ₂ eq														
	GWP	2,087.5														
Sound power level	Nom.	dBA		40				41		44		41		44		
Sound pressure level	Nom.	dBA		26				27		30		27		30		

Outdoor Unit		ERLQ		004CV3	006CV3	008CV3	011CV3	014CV3	016CV3	011CW1	014CW1	016CW1						
Dimensions	Unit	HeightxWidthxDp		mm				735x832x307					1,345x900x320					
Weight	Unit	kg																
		54	56			113		114										
Compressor	Quantity	1																
	Type	Hermetically sealed swing compressor					Hermetically sealed scroll compressor											
Operation range	Cooling	Min.~Max.		°CDB				10.0~43.0					10.0~46.0					
	Domestic hot water	Min.~Max.		°CDB				-25~35					-20~35					
Refrigerant	Type	R-410A																
	GWP	2,087.5																
	Charge	TCO ₂ eq		3.1				3.3		7.1		3.4						
		kg		1.5				1.6		3.4								
		Expansion valve (electronic type)																
Sound power level	Heating	Nom.		dBA				61		62		64		66		64		66
	Cooling	Nom.		dBA				63					64		66		69	
Sound pressure level	Heating	Nom.		dBA				48		49		51		52		51		52
	Cooling	Nom.		dBA				48		49		50		52		50		54
Power supply	Name/Phase/Frequency/Voltage		Hz/V		V3/1~/50/230							W1/3N~/50/400						
Current	Recommended fuses		A		16				20		40		20					

(1) Cooling Ta 35°C - LWE 18°C (DT = 5°C); heating Ta DB/WB 7°C/6°C - LWC 35°C (DT = 5°C) (2) Cooling Ta 35°C - LWE 7°C (DT = 5°C); heating Ta DB/WB 7°C/6°C - LWC 45°C (DT = 5°C) (3) Ta DB -7°C (RH85%) - LWC 35°C (4) Ta DB -7°C (RH85%) - LWC 45°C (5) Contains fluorinated greenhouse gases

Daikin Altherma low temperature split



Efficiency data			EHBH + ERHQ	11CB3V/9W + 011BV3	16CB3V/9W + 014BV3	16CB3V/9W + 016BV3	11CB3V/9W + 011BW1	16CB3V/9W + 014BW1	16CB3V/9W + 016BW1
Heating capacity	Nom.			11.2 (1) / 10.3 (2)	14.0 (1) / 13.1 (2)	16.0 (1) / 15.2 (2)	11.3 (1) / 11.0 (2)	14.5 (1) / 13.6 (2)	16.1 (1) / 15.1 (2)
Power input	Heating	Nom.		2.55 (1) / 3.17 (2)	3.26 (1) / 4.04 (2)	3.92 (1) / 4.75 (2)	2.63 (1) / 3.24 (2)	3.42 (1) / 4.21 (2)	3.82 (1) / 4.69 (2)
COP				4.39 (1) / 3.25 (2)	4.29 (1) / 3.24 (2)	4.08 (1) / 3.20 (2)	4.30 (1) / 3.39 (2)	4.24 (1) / 3.22 (2)	4.20 (1) / 3.22 (2)
Domestic hot water heating	General	Declared load profile		-					
	Average climate	η_{wh} (water heating efficiency)	%	-					
		Water heating energy efficiency class		-					
Space heating	Average climate water outlet 55°C	General	SCOP	2.86	2.82	2.92	2.90	2.80	2.96
			η_s (Seasonal space heating efficiency)	112	110	114	113	109	115
		Seasonal space heating eff. class	A+						
	Average climate water outlet 35°C	General	SCOP	2.99	3.23	3.29	3.08	3.34	3.33
		η_s (Seasonal space heating efficiency)	117	126	129	120	131	130	
		Seasonal space heating eff. class		A	A+		A	A+	

Indoor Unit			EHBH	11CB3V/9W	16CB3V/9W	16CB3V/9W	11CB3V/9W	16CB3V/9W	16CB3V/9W			
Casing	Colour		White									
	Material		Precoated sheet metal									
Dimensions	Unit	HeightxWidthxDepth	mm 890x480x344									
Weight	Unit		43	44	45	44	45	43	44	45	44	45
Operation range	Heating	Water side Min.~Max.	°C 15~55									
	Domestic hot water	Water side Min.~Max.	°C 25~80									
Refrigerant	Charge	TCO ₂ eq	-									
	GWP		2,087.5									
Sound power level	Nom.	dBA	41	44			41	44				
Sound pressure level	Nom.	dBA	27	30			27	30				

Outdoor Unit			ERHQ	011BV3	014BV3	016BV3	011BW1	014BW1	016BW1		
Dimensions	Unit	HeightxWidthxDepth	mm	1,170x900x320			1,345x900x320				
Weight	Unit		kg	102			108				
Compressor	Quantity		1								
	Type		Hermetically sealed scroll compressor								
Operation range	Cooling	Min.~Max.	°CDB 10.0~46.0								
	Domestic hot water	Min.~Max.	°CDB -20~35								
Refrigerant	Type		R-410A								
	Charge	kg	2.7			3.0					
		TCO ₂ eq	5.6			6.3					
	GWP		2,087.5								
Sound power level	Control		Expansion valve (electronic type)								
	Heating	Nom.	dBA	64		66		64		66	
	Cooling	Nom.	dBA	64	66	69	64	66	69		
Sound pressure level	Heating	Nom.	dBA	49	51	53	51		52		
	Cooling	Nom.	dBA	50	52	54	50	52	54		
Power supply	Name/Phase/Frequency/Voltage	Hz/V	V3/1~/50/230				W1/3N~/50/400				
Current	Recommended fuses	A	32				20				

(1) Cooling Ta 35°C - LWE 18°C (DT = 5°C); heating Ta DB/WB 7°C/6°C - LWC 35°C (DT = 5°C) (2) Cooling Ta 35°C - LWE 7°C (DT = 5°C); heating Ta DB/WB 7°C/6°C - LWC 45°C (DT = 5°C) (3) Contains fluorinated greenhouse gases

Daikin Altherma low temperature split



Wall mounted **reversible** air to water heat pump ideal for low energy houses

- › Wall mounted indoor unit
- › Energy efficient heating and cooling system based on air to water heat pump technology
- › Perfect fit for new built as well as for low energy houses
- › Best seasonal efficiencies, providing the highest savings on running costs
- › Flexible configuration with respect to heat emitters
- › Possible to combine with domestic hot water
- › Outdoor unit extracts heat from the outdoor air, even at -25°C

Efficiency data			EHBX + ERLQ	04CB3V + 004CV3	08CB3V/9W + 006CV3	08CB3V/9W + 008CV3	11CB3V/9W + 011CV3	16CB3V/9W + 014CV3	16CB3V/9W + 016CV3	11CB3V/9W + 011CW1	16CB3V/9W + 014CW1	16CB3V/9W + 016CW1
Heating capacity	Nom.		kW	4.40 (1) / 4.03 (2)	6.00 (1) / 5.67 (2)	7.40 (1) / 6.89 (2)	11.2 (1) / 11.0 (2)	14.5 (1) / 13.6 (2)	16.0 (1) / 15.2 (2)	11.2 (1) / 11.0 (2)	14.5 (1) / 13.6 (2)	16.0 (1) / 15.2 (2)
Cooling capacity	Nom.		kW	4.08 (1) / 4.17 (2)	5.88 (1) / 4.84 (2)	6.20 (1) / 5.36 (2)	12.1 (1) / 11.7 (2)	12.7 (1) / 12.6 (2)	13.8 (1) / 13.1 (2)	12.1 (1) / 11.7 (2)	12.7 (1) / 12.6 (2)	13.8 (1) / 13.1 (2)
Power input	Heating	Nom.	kW	0.870 (1) / 1.13 (2)	1.27 (1) / 1.59 (2)	1.66 (1) / 2.01 (2)	2.43 (1) / 3.10 (2)	3.37 (1) / 4.10 (2)	3.76 (1) / 4.66 (2)	2.43 (1) / 3.10 (2)	3.37 (1) / 4.10 (2)	3.76 (1) / 4.66 (2)
	Cooling	Nom.	kW	0.900 (1) / 1.180 (2)	1.51 (1) / 2.07 (2)	1.64 (1) / 2.34 (2)	3.05 (1) / 4.31 (2)	3.21 (1) / 5.08 (2)	3.74 (1) / 5.73 (2)	3.05 (1) / 4.31 (2)	3.21 (1) / 5.08 (2)	3.74 (1) / 5.73 (2)
COP				5.04 (1) / 3.58 (2)	4.74 (1) / 3.56 (2)	4.45 (1) / 3.42 (2)	4.60 (1) / 3.55 (3) / 2.75 (2) / 2.10 (4)	4.30 (1) / 3.32 (3) / 2.65 (2) / 2.08 (4)	4.25 (1) / 3.26 (3) / 2.64 (2) / 2.09 (4)	4.60 (1) / 3.55 (3) / 2.75 (2) / 2.10 (4)	4.30 (1) / 3.32 (3) / 2.65 (2) / 2.08 (4)	4.25 (1) / 3.26 (3) / 2.64 (2) / 2.09 (4)
EER				4.55 (1) / 2.32 (2)	3.89 (1) / 2.34 (2)	3.79 (1) / 2.29 (2)	3.98 (1) / 2.72 (2)	3.96 (1) / 2.47 (2)	3.69 (1) / 2.29 (2)	3.98 (1) / 2.72 (2)	3.96 (1) / 2.47 (2)	3.69 (1) / 2.29 (2)
Domestic hot water heating	General	Declared load profile										
	Average climate	η _{wh} (water heating efficiency) %										
				Water heating energy efficiency class								
Space heating	Average climate water outlet 55°C	General	SCOP	3.20	3.22	3.23	3.09	3.16	3.06	3.09	3.16	3.06
			η _s (Seasonal space heating efficiency) %	125	126			120	123	119	120	123
			Seasonal space heating eff. class	A++				A+				
	Average climate water outlet 35°C	General	SCOP	4.52	4.29	4.34	3.98	3.90	3.80	3.98	3.90	3.80
		η _s (Seasonal space heating efficiency) %	178	169	171	156	153	149	156	153	149	
				A++				A+	A++		A+	

Indoor Unit			EHBX	04CB3V	08CB3V/9W	08CB3V/9W	11CB3V/9W	16CB3V/9W	16CB3V/9W	11CB3V/9W	16CB3V/9W	16CB3V/9W	
Casing	Colour	White											
	Material	Precoated sheet metal											
Dimensions	Unit	HeightxWidthxDepth	mm										
Weight	Unit	kg											
Operation range	Heating	Water side Min.~Max.	°C										
	Cooling	Water side Min.~Max.	°C										
	Domestic hot water	Water side Min.~Max.	°C										
Refrigerant	Charge	TCO ₂ eq											
	GWP												
Sound power level	Nom.	dBA		40		41		44		41		44	
Sound pressure level	Nom.	dBA		26		27		30		27		30	

Outdoor Unit			ERLQ	004CV3	006CV3	008CV3	011CV3	014CV3	016CV3	011CW1	014CW1	016CW1		
Dimensions	Unit	HeightxWidthxDepth	mm				mm							
Weight	Unit	kg												
Compressor	Quantity	1												
	Type	Hermetically sealed swing compressor					Hermetically sealed scroll compressor							
Operation range	Cooling	Min.~Max.	°CDB				°CDB							
	Domestic hot water	Min.~Max.	°CDB				°CDB							
Refrigerant	Type	R-410A												
	GWP	2,087.5												
	Charge	TCO ₂ eq		3.1		3.3		7.1		3.4				
	Control	Expansion valve (electronic type)												
Sound power level	Heating	Nom.	dBA		61		62		64		66		66	
	Cooling	Nom.	dBA		63		64		66		69		69	
Sound pressure level	Heating	Nom.	dBA		48		49		51		52		52	
	Cooling	Nom.	dBA		48		49		50		52		54	
Power supply	Name/Phase/Frequency/Voltage		Hz/V		V3/1~/50/230						W1/3N~/50/400			
Current	Recommended fuses		A		16		20		40		20			

(1) Cooling Ta 35°C - LWE 18°C (DT = 5°C); heating Ta DB/WB 7°C/6°C - LWC 35°C (DT = 5°C) (2) Cooling Ta 35°C - LWE 7°C (DT = 5°C); heating Ta DB/WB 7°C/6°C - LWC 45°C (DT = 5°C) (3) Ta DB -7°C (RH85%) - LWC 35°C (4) Ta DB -7°C (RH85%) - LWC 45°C (5) Contains fluorinated greenhouse gases

Daikin Altherma low temperature split



Efficiency data				EHBX + ERHQ	11CB3V/9W + 011BV3	16CB3V/9W + 014BV3	16CB3V/9W + 016BV3	11CB3V/9W + 011BW1	16CB3V/9W + 014BW1	16CB3V/9W + 016BW1					
Heating capacity	Nom.		kW	11.2 (1) / 10.3 (2)	14.0 (1) / 13.1 (2)	16.0 (1) / 15.2 (2)	11.3 (1) / 11.0 (2)	14.5 (1) / 13.6 (2)	16.1 (1) / 15.1 (2)						
Cooling capacity	Nom.		kW	13.9 (1) / 10.0 (2)	17.3 (1) / 12.5 (2)	17.8 (1) / 13.1 (2)	15.1 (1) / 11.7 (2)	16.1 (1) / 12.6 (2)	16.8 (1) / 13.1 (2)						
Power input	Heating	Nom.	kW	2.55 (1) / 3.17 (2)	3.26 (1) / 4.04 (2)	3.92 (1) / 4.75 (2)	2.63 (1) / 3.24 (2)	3.42 (1) / 4.21 (2)	3.82 (1) / 4.69 (2)						
	Cooling	Nom.	kW	3.86 (1) / 3.69 (2)	5.86 (1) / 5.69 (2)	6.87 (1) / 5.95 (2)	4.53 (1) / 4.31 (2)	5.43 (1) / 5.08 (2)	6.16 (1) / 5.73 (2)						
COP				4.39 (1) / 3.25 (2)	4.29 (1) / 3.24 (2)	4.08 (1) / 3.20 (2)	4.30 (1) / 3.39 (2)	4.24 (1) / 3.22 (2)	4.20 (1) / 3.22 (2)						
EER				3.60 (1) / 2.71 (2)	2.95 (1) / 2.32 (2)	2.59 (1) / 2.20 (2)	3.32 (1) / 2.72 (2)	2.96 (1) / 2.47 (2)	2.72 (1) / 2.29 (2)						
Domestic hot water heating	General	Declared load profile													
	Average climate	η_{wh} (water heating efficiency)	%												
Space heating	Average climate water outlet 55°C	General	SCOP	2.86	2.82	2.92	2.90	2.80	2.96						
			η_s (Seasonal space heating efficiency)	112	110	114	113	109	115						
		Seasonal space heating eff. class	A+												
	Average climate water outlet 35°C	General	SCOP	2.99	3.23	3.29	3.08	3.34	3.33						
			η_s (Seasonal space heating efficiency)	117	126	129	120	131	130						
			Seasonal space heating eff. class	A	A+		A	A+							
Indoor Unit				EHBX	11CB3V/9W	16CB3V/9W	16CB3V/9W	11CB3V/9W	16CB3V/9W	16CB3V/9W					
Casing	Colour	White													
	Material	Precoated sheet metal													
Dimensions	Unit	HeightxWidthxDepth	mm	890x480x344											
Weight	Unit		kg	43	45	44	46	44	46	43	45	44	46	44	46
Operation range	Heating	Water side	Min.~Max.	15~55											
	Cooling	Water side	Min.~Max.	5~22											
	Domestic hot water	Water side	Min.~Max.	25~80											
Refrigerant	Charge		TCO ₂ eq	-											
	GWP			2,087.5											
Sound power level	Nom.		dBA	41		44		41		44					
Sound pressure level	Nom.		dBA	27		30		27		30					
Outdoor Unit				ERHQ	011BV3	014BV3	016BV3	011BW1	014BW1	016BW1					
Dimensions	Unit	HeightxWidthxDepth	mm	1,170x900x320					1,345x900x320						
Weight	Unit		kg	102					108						
Compressor	Quantity			1											
	Type			Hermetically sealed scroll compressor											
Operation range	Cooling	Min.~Max.	°CDB	10.0~46.0											
	Domestic hot water	Min.~Max.	°CDB	-20~35											
Refrigerant	Type			R-410A											
	Charge		kg	2.7					3.0						
			TCO ₂ eq	5.6					6.3						
	GWP			2,087.5											
	Control			Expansion valve (electronic type)											
Sound power level	Heating	Nom.	dBA	64			66			64			66		
	Cooling	Nom.	dBA	64		66		69		64		66		69	
Sound pressure level	Heating	Nom.	dBA	49			51			53			52		
	Cooling	Nom.	dBA	50		52		54		50		52		54	
Power supply	Name/Phase/Frequency/Voltage		Hz/V	V3/1~/50/230					W1/3N~/50/400						
Current	Recommended fuses		A	32					20						

(1) Cooling Ta 35°C - LWE 18°C (DT = 5°C); heating Ta DB/WB 7°C/6°C - LWC 35°C (DT = 5°C) (2) Cooling Ta 35°C - LWE 7°C (DT = 5°C); heating Ta DB/WB 7°C/6°C - LWC 45°C (DT = 5°C) (3) Contains fluorinated greenhouse gases

Daikin Altherma small capacity monobloc



Why choose Daikin Altherma low temperature monobloc?

The simple answer is that our inverter technology delivers **leading edge performance**, all the hydraulic components are pre-installed in the outdoor unit which is the **smallest in the market**, and it works with all our output devices.

All hydraulic components are combined in the outdoor unit

Available in 5kW and 7kW models, the new Daikin Altherma LT monobloc requires only a controller indoors, when space heating is needed. For use of both space heating and domestic hot water, a wiring centre is added. And the outdoor unit can be installed almost anywhere, under a window sill, or in the smallest of gardens. So it's a natural fit for new build and renovation projects alike.

The space-saving design is ideal for homes where space is limited

- › The outdoor unit includes all hydraulic components
Smallest installed volume in the market:
H735 x W1085 x D360 mm –only 80 kg
- › The separate installation of controller and wiring centre allows a flexible installation in the house.

Everything you need from one source

The Daikin Altherma monobloc works efficiently with Daikin's range of under-floor heating, radiators and fan convectors and can be combined with solar thermal systems. So you can count on Daikin for your entire project.



Supporting tools

Extranet

- › Experience our new business portal at my.daikin.eu
- › Find information easily
- › Access via mobile or desktop
- › Customise the options so you see only info relevant for you

Internet

- › Find our solutions for different applications on www.daikineurope.com/for-your-home/needs/heating/

Literature

- › See all the literature available on www.daikineurope.com/support-and-manuals/catalogues

Software

- › Calculate your energy savings: <http://ecocalc.daikin.eu>



Daikin Altherma low temperature monobloc

Small capacity air to water monobloc system, ideal when indoor space is limited

- › Compact monobloc for space heating with optional domestic hot water
- › Fuss-free installation : only water connections required
- › Reliable operation even when -25°C outside thanks to frost protection features such as free hanging coil
- › COP up to 5 with typical annual efficiencies up to 300%



Single Unit				EDLQ/EBLQ	05CV3	07CV3	05CV3	07CV3
Heating capacity	Nom.		kW		4.40 (1) / 4.03 (2)	7.00 (1) / 6.90 (2)	4.40 (1) / 4.03 (2)	7.00 (1) / 6.90 (2)
Cooling capacity	Nom.		kW		-	-	3.88 (1) / 4.17 (2)	5.20 (1) / 5.36 (2)
Power input	Cooling	Nom.	kW		-	-	0.950 (1) / 1.80 (2)	1.37 (1) / 2.34 (2)
	Heating	Nom.	kW		0.880 (1) / 1.13 (2)	1.55 (1) / 2.02 (2)	0.880 (1) / 1.13 (2)	1.55 (1) / 2.02 (2)
COP					5.00 (1) / 3.58 (2)	4.52 (1) / 3.42 (2)	5.00 (1) / 3.58 (2)	4.52 (1) / 3.42 (2)
EER					-	-	4.07 (1) / 2.32 (2)	3.80 (1) / 2.29 (2)
Dimensions	Unit	Height	mm		735			
		Width	mm		1,090			
		Depth	mm		350			
Weight	Unit		kg	76.0	80.0	76.0	80.0	
Operation range	Heating	Water side	Min.-Max.	°C	15~55.0			
			Ambient	Min.-Max.	°CDB	---		
	Cooling	Water side	Min.-Max.	°C	---			
			Ambient	Min.-Max.	°CDB	10.0~43.0		
Domestic hot water	Ambient	Water side	Min.-Max.	°CDB	-25.0~35.0			
			Min.-Max.	°C	25~80			
Refrigerant	Type			R-410A				
	GWP			2,087.5				
	Charge		kg	1.3	1.5	1.3	1.5	
			TCO ₂ eq	2.7	3.0	2.7	3.0	
			Control	Expansion valve (electronic type)				
Sound power level	Heating	Nom.	dBA	60				
			Cooling	Nom.	dBA	63.0		
Sound pressure level	Heating	Nom.	dBA	50				
			Cooling	Nom.	dBA	50		
Space heating	Average climate water outlet 55°C	General	η _s (Seasonal space heating efficiency)	%	125	126	125	126
			SCOP		3.20	3.22	3.20	3.22
	Average climate water outlet 35°C	General	Seasonal space heating eff. class		A++			
			η _s (Seasonal space heating efficiency)	%	172	163	172	163
			SCOP		4.39	4.14	4.39	4.14
			Seasonal space heating eff. class		A++			

(1) cooling Ta 35°C - LWE 18°C (DT = 5°C); heating Ta DB/WB 7°C/6°C - LWC 35°C (DT = 5°C) (2) cooling Ta 35°C - LWE 7°C (DT = 5°C); heating Ta DB/WB 7°C/6°C - LWC 45°C (DT = 5°C)

(3) Contains fluorinated greenhouse gases

Wiring centre				EKCB07CV3	EK2CB07CV3
Dimensions	Unit	Height	mm	360	
		Width	mm	340	
		Depth	mm	97	
Weight	Unit		kg	4	
Operation range	Heating	Ambient	Min.-Max.	-	
			Indoor installation	Ambient	Min.
				Max.	°CDB
Refrigerant	Charge		TCO ₂ eq	-	
	Control			-	
	GWP			-	

Back-up heater kit				EKMBUHC3V3	EKMBUHC9W1
Dimensions	Unit	Height	mm	560	
		Width	mm	250	
		Depth	mm	210	
Weight	Unit		kg	11	13
Operation range	Heating	Ambient	Min.-Max.	-	
			Indoor installation	Ambient	Min.
				Max.	°CDB
Refrigerant	Charge		TCO ₂ eq	-	
	Control			-	
	GWP			-	

Daikin Altherma low temperature monobloc



Reversible air to water monobloc system, ideal when indoor space is limited

- › Energy efficient **heating and cooling** system based on air to water heat pump technology
- › Low energy bills and low CO₂ emissions
- › H₂O piping between outdoor unit and indoor heat emitters
- › Inverter controlled scroll compressor
- › Built-in electric back-up heater as additional heating during extremely cold outdoor temperature
- › Possible to combine with domestic hot water
- › Outdoor unit extracts heat from the outdoor air, even at -25°C

Single Unit				EBLQ/EBHQ	011BB6V3	014BB6V3	016BB6V3	011BB6W1	014BB6W1	016BB6W1				
Heating capacity	Nom.		kW	11.20 (1) / 10.87 (2)	14.00 (1) / 13.10 (2)	16.00 (1) / 15.06 (2)	11.20 (1) / 10.87 (2)	14.00 (1) / 13.10 (2)	16.00 (1) / 15.06 (2)					
Cooling capacity	Nom.		kW	12.9 (1) / 10.0 (2)	16.0 (1) / 12.5 (2)	16.7 (1) / 13.1 (2)	12.9 (1) / 10.0 (2)	16.0 (1) / 12.5 (2)	16.7 (1) / 13.1 (2)					
Power input	Cooling	Nom.	kW	3.87 (1) / 3.69 (2)	5.75 (1) / 5.39 (2)	6.36 (1) / 5.93 (2)	3.87 (1) / 3.69 (2)	5.40 (1) / 5.06 (2)	6.15 (1) / 5.75 (2)					
	Heating	Nom.	kW	2.56 (1) / 3.31 (2)	3.29 (1) / 4.01 (2)	3.88 (1) / 4.71 (2)	2.60 (1) / 3.21 (2)	3.30 (1) / 4.07 (2)	3.81 (1) / 4.66 (2)					
COP				4.38 (1) / 3.28 (2)	4.25 (1) / 3.27 (2)	4.12 (1) / 3.20 (2)	4.31 (1) / 3.38 (2)	4.24 (1) / 3.22 (2)	4.20 (1) / 3.23 (2)					
EER				3.32 (1) / 2.71 (2)	2.78 (1) / 2.32 (2)	2.63 (1) / 2.21 (2)	3.32 (1) / 2.71 (2)	2.96 (1) / 2.47 (2)	2.72 (1) / 2.28 (2)					
Dimensions	Unit	Height	mm	1,418										
		Width	mm	1,435										
		Depth	mm	382										
Weight	Unit		kg	180										
Hydraulic component	Back-up heater current	Type		6V3						6W1				
		Power supply	Phase/ Frequency/ Voltage	1~/50/230						3~/50/400				
Operation range	Heating	Ambient	Min.~Max. °CWB	-20~-35	-15~-35	-20~-35	-15~-35	-20~-35	-15~-35	-25~-35	-15~-35	-25~-35	-15~-35	-15~-35
		Water side	Min.~Max. °C	15 (3)~55 (3)										
	Cooling	Ambient	Min.~Max. °CDB	10~46										
		Water side	Min.~Max. °C	5~22										
Domestic hot water	Ambient	Min.~Max. °CDB	-20~43	-15~43	-20~43	-15~43	-20~43	-15~43	-25~43	-15~43	-25~43	-15~43	-15~43	
Refrigerant	Type			R-410A										
	Charge		kg	3.0										
	Control	GWP		TCO _{2eq}	6.2									
					Expansion valve (electronic type)									
Sound power level	Heating	Nom.	dBA	64	65	66	64	65	66					
	Cooling	Nom.	dBA	65	66	69	65	66	69					
Sound pressure level	Heating	Nom.	dBA	51			52	49	51	53				
	Cooling	Nom.	dBA	50	52	54	50	52	54					
Compressor component	Main power supply	Name		V3						W1				
		Phase		1~						3N~				
		Frequency	Hz	50										
		Voltage	V	230						400				
Space heating	Average climate water outlet 55°C	General	η _s (Seasonal space heating efficiency)	%	105		101	107	110	111				
					SCOP	2.70	2.71	2.60	2.75	2.82	2.85			
					Seasonal space heating eff. class	A+								
	Average climate water outlet 35°C	General	η _s (Seasonal space heating efficiency)	%	129		130	123	129	130	127			
					SCOP	3.30	3.32	3.15	3.30	3.31	3.25			
					Seasonal space heating eff. class	A+								

(1) cooling Ta 35°C - LWE 18°C (DT = 5°C); heating Ta DB/WB 7°C/6°C - LWC 35°C (DT = 5°C) (2) cooling Ta 35°C - LWE 7°C (DT = 5°C); heating Ta DB/WB 7°C/6°C - LWC 45°C (DT = 5°C)
 (3) 15°C-25°C: BUH only, no heat pump operation = during commissioning

Daikin Altherma low temperature monobloc

Heating only air to water monobloc system, ideal when indoor space is limited



Single Unit		EDLQ/EDHQ		011BB6V3		014BB6V3		016BB6V3		011BB6W1		014BB6W1		016BB6W1				
Heating capacity	Nom.	kW		11.20 (1) / 10.87 (2)		14.00 (1) / 13.10 (2)		16.00 (1) / 15.06 (2)		11.20 (1) / 10.87 (2)		14.00 (1) / 13.10 (2)		16.00 (1) / 15.06 (2)				
Power input	Heating	Nom.		kW		2.56 (1) / 3.31 (2)		3.29 (1) / 4.01 (2)		3.88 (1) / 4.71 (2)		2.60 (1) / 3.21 (2)		3.30 (1) / 4.07 (2)		3.81 (1) / 4.66 (2)		
COP				4.38 (1) / 3.28 (2)		4.25 (1) / 3.27 (2)		4.12 (1) / 3.20 (2)		4.31 (1) / 3.38 (2)		4.24 (1) / 3.22 (2)		4.20 (1) / 3.23 (2)				
Dimensions	Unit	Height		mm				1,418										
		Width		mm				1,435										
		Depth		mm				382										
Weight	Unit			kg				180										
Hydraulic component	Back-up heater current	Type				6V3						6W1						
		Power supply	Phase/Frequency/Voltage	Hz/V		1~/50/230				3~/50/400								
Operation range	Heating	Ambient	Min.-Max.	°CWB	-20~-35	-15~-35	-20~-35	-15~-35	-20~-35	-15~-35	-25~-35	-15~-35	-25~-35	-15~-35	-25~-35	-15~-35		
			Water side	Min.-Max.	°C	15 (3)~-55 (3)												
		Domestic hot water	Ambient	Min.-Max.	°CDB	-20~-43	-15~-43	-20~-43	-15~-43	-20~-43	-15~-43	-25~-43	-15~-43	-25~-43	-15~-43	-25~-43	-15~-43	
Refrigerant	Type																	
	Charge		kg															
	Control		TCO ₂ eq															
	GWP																	
Sound power level	Heating	Nom.		dBA		64		65		66		64		65		66		
	Heating	Nom.		dBA		51				52		49		51		53		
Compressor component	Main power supply	Name				V3						W1						
		Phase				1~						3N~						
		Frequency		Hz						50								
Space heating	Average climate water outlet 55°C	General	η _s (Seasonal space heating efficiency)	%	105				101		107		110		111			
					SCOP		2.70		2.71		2.60		2.75		2.82		2.85	
					Seasonal space heating eff. class		A+											
	Average climate water outlet 35°C	General	η _s (Seasonal space heating efficiency)	%	129		130		123		129		130		127			
					SCOP		3.30		3.32		3.15		3.30		3.31		3.25	
					Seasonal space heating eff. class		A+											

(1) cooling Ta 35°C - LWE 18°C (DT = 5°C); heating Ta DB/WB 7°C/6°C - LWC 35°C (DT = 5°C) (2) cooling Ta 35°C - LWE 7°C (DT = 5°C); heating Ta DB/WB 7°C/6°C - LWC 45°C (DT = 5°C) (3) 15°C-25°C: BUH only, no heat pump operation = during commissioning

Domestic hot water tank

Plastic domestic hot water tank with solar support

- › Tank designed for connection with thermal solar collectors
- › Available in 300 and 500 liters
- › Large hot water storage tank to provide domestic hot water at any time
- › Heat loss is reduced to a minimum thanks to the high quality insulation
- › Space heating support possible (500l tank only)



Accessory				EKHWP	300B	500B	
Casing	Colour	Traffic white (RAL9016) / Dark grey (RAL7011)					
	Material	Impact resistant polypropylene					
Dimensions	Unit	Width	mm	595		790	
		Depth	mm	615		790	
		Empty	kg	58		82	
Weight	Unit						
	Empty						
Tank	Water volume	l					
	Material	Polypropylen					
	Maximum water temperature	°C					
	Insulation	Heat loss	kWh/24h	1.5		1.7	
	Energy efficiency class	B					
	Standing heat loss	W					
	Storage volume	l					
Heat exchanger	Domestic hot water	Quantity	1				
		Tube material	Stainless steel (DIN 1.4404)				
		Face area	m ²	5,600		5,800	
		Internal coil volume	l	27.1		29.0	
		Operating pressure	bar	6			
		Average specific thermal output	W/K	2,790		2,825	
	Charging	Quantity	1				
		Tube material	Stainless steel (DIN 1.4404)				
		Face area	m ²	3		4	
		Internal coil volume	l	13		19	
		Operating pressure	bar	3			
		Average specific thermal output	W/K	1,300		1,800	
	Auxiliary solar heating	Tube material	Stainless steel (DIN 1.4404)				
		Face area	m ²	-		1	
Internal coil volume		l	-		2		
Operating pressure		bar	-		3		
Average specific thermal output		W/K	-		280		

EKHWP-PB

Domestic hot water tank

Pressureless domestic hot water tank with solar support

- › Tank designed for connection with pressurised thermal solar system
- › Available in 300 and 500 liters
- › Large hot water storage tank to provide domestic hot water at any time
- › Heat loss is reduced to a minimum thanks to the high quality insulation
- › Space heating support possible (500l tank only)



Accessory				EKHWP	300PB	500PB	
Casing	Colour	Traffic white (RAL9016) / Dark grey (RAL7011)					
	Material	Impact resistant polypropylene					
Dimensions	Unit	Width	mm	595		790	
		Depth	mm	615		790	
		Empty	kg	58		89	
Weight	Unit						
	Empty						
Tank	Water volume	l					
	Material	Polypropylen					
	Maximum water temperature	°C					
	Insulation	Heat loss	kWh/24h	1.5		1.7	
	Energy efficiency class	B					
	Standing heat loss	W					
	Storage volume	l					
Heat exchanger	Domestic hot water	Quantity	1				
		Tube material	Stainless steel (DIN 1.4404)				
		Face area	m ²	5,600		5,800	
		Internal coil volume	l	27.1		29.0	
		Operating pressure	bar	6			
		Average specific thermal output	W/K	2,790		2,825	
	Charging	Quantity	1				
		Tube material	Stainless steel (DIN 1.4404)				
		Face area	m ²	3		4	
		Internal coil volume	l	13		19	
		Operating pressure	bar	3			
		Average specific thermal output	W/K	1,300		1,800	
	Auxiliary solar heating	Tube material	Stainless steel (DIN 1.4404)				
		Face area	m ²	-		1	
Internal coil volume		l	-		2		
Operating pressure		bar	-		3		
Average specific thermal output		W/K	-		280		

Domestic hot water tank

Enameled domestic hot water tank

- › Enameled domestic hot water tank
- › Available in 150, 200 and 300 liters



Accessory		EKHWE	150A3V3	200A3V3	300A3V3	200A3Z2	300A3Z2	
Casing	Colour		RAL9010					
	Material		Epoxy coated steel					
Dimensions	Unit	Diameter	545		660	545	660	
	Unit	Empty	kg	80	104	140	104	140
Tank	Water volume	l	150	200	300	200	300	
	Material		Enamel coated steel acc. DIN4753TL2					
	Maximum water temperature	°C	75					
	Insulation	Heat loss	kWh/24h	1.7	1.9	2.5	1.9	2.5
	Energy efficiency class		C		D	C	D	
	Standing heat loss	W	71	79	104	79	104	
	Storage volume	l	150	200	300	200	300	
Heat exchanger	Quantity		1					
Booster heater	Capacity	kW	3					
Power supply	Phase/Frequency/Voltage	Hz/V	1~/50/230			2~/50/400		

EKHWS-B3V3/Z2

Domestic hot water tank

Stainless steel domestic hot water tank

- › Stainless steel domestic hot water tank
- › Available in 150, 200 and 300 liters



Accessory		EKHWS	150B3V3	200B3V3	300B3V3	200B3Z2	300B3Z2	
Casing	Colour		Neutral white					
	Material		Epoxy-coated mild steel					
Dimensions	Unit	Width	580					
	Unit	Depth	580					
Weight	Unit	Empty	kg	37	45	59	45	59
	Water volume	l	150	200	285	200	285	
Tank	Material		Stainless steel (DIN 1.4521)					
	Maximum water temperature	°C	85					
	Insulation	Heat loss	kWh/24h	155.0	177.0	219.0	177.0	219.0
	Energy efficiency class		C					
	Standing heat loss	W	65	74	91	74	91	
	Storage volume	l	150	200	285	200	285	
Heat exchanger	Quantity		1					
	Tube material		Duplex steel LDX 2101					
Booster heater	Capacity	kW	3					
Power supply	Phase/Frequency/Voltage	Hz/V	1~/50/230			2~/50/400		

Pump station

- › Save energy and reduce CO₂ emissions with a solar system for domestic hot water production
- › Pump station connectable to unpressurised solar system
- › Pump station and control provide the transfer of solar heat to the domestic hot water tank



Pump station for pressureless tank				EKSRPS4A
Dimensions	Unit	HeightxWidthxDepth	mm	815x142x230
Weight	Unit		kg	6
Power supply	Phase			1~
	Frequency		Hz	50
	Voltage		V	230

Pump station

Pump station for pressurised tank				EKSRDS2A
Mounting				On wall
Dimensions	Unit	HeightxWidthxDepth	mm	410x314x154
Weight	Unit		kg	6
Operation range	Ambient temperature	Min.~Max.	°C	0~40
Operating pressure	Max.		bar	6
Stand still temperature	Max.		°C	120
Thermal performance	collector efficiency (η _{col})		%	-
	Zero loss collector efficiency η ₀		%	-
Control	Type			Digital temperature difference controller with plain text display
	Power consumption		W	5
Power supply	Frequency/Voltage		V	50/230
Sensor	Solar panel temperature sensor			Pt1000
Power supply intake				Indoor unit

Solar collector

Thermal solar collector for hot water production

- › Solar collectors can produce up to 70% of the energy needed for hot water production - a major cost saving
- › Vertical and horizontal solar collectors for domestic hot water production
- › High efficiency collectors transfer all the short-wave solar radiation into heat as a result of their highly selective coating
- › Easy to install on roof tiles

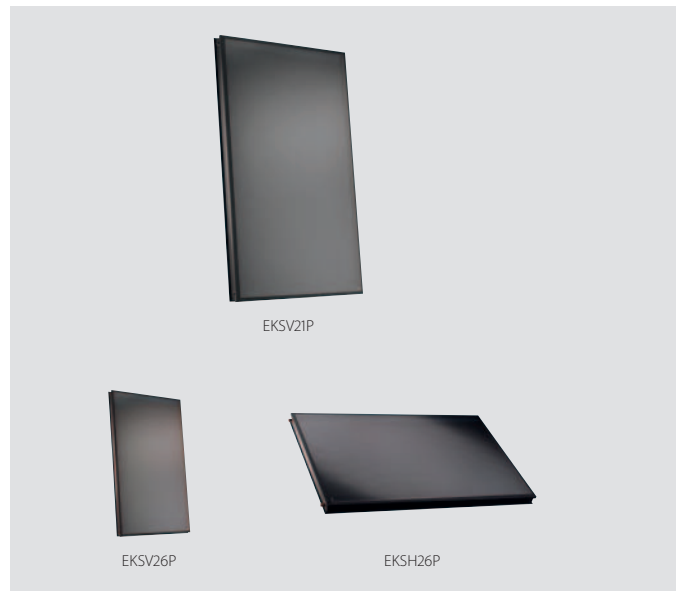

Solar collector				EKS21P	EKS26P	EKSH26P
Mounting				Vertical		Horizontal
Dimensions	Unit	HeightxWidthxDepth	mm	1,006x85x2,000		2,000x85x1,300
Weight	Unit		kg	33		42
Volume			l	1.3	1.7	2.1
Surface	Outer		m ²	2.01		2.60
	Aperture		m ²	1.800		2.360
	Absorber		m ²	1.79		2.35
Coating				Micro-therm (absorption max. 96%, Emission ca. 5% +/-2%)		
Absorber				Harp-shaped copper pipe register with laser-welded highly selective coated aluminium plate		
Glazing				Single pane safety glass, transmission +/- 92%		
Allowed roof angle	Min.~Max.		°	15~80		
Operating pressure	Max.		bar	6		
Stand still temperature	Max.		°C	192		
Thermal performance	collector efficiency (η _{col})		%	61		
	Zero loss collector efficiency η ₀		%	0.781		0.784
	Heat loss coefficient a ₁		W/m ² .K	4.240		4.250
	Temperature dependence of the heat loss coefficient a ₂		W/m ² .K ²	0.006		0.007
	Thermal capacity		kJ/K	4.9		6.5

User interface

- › User friendly remote control with contemporary design
- › For control of space heating, cooling and domestic hot water with among others reheat, scheduled and booster mode
- › Easy to use: all main functions directly accessible
- › An additional user interface can be a room thermostat in the space to be heated.
- › Several languages possible depending on the model : English, German, Dutch, Spanish, Italian, French, Greek, Russian, etc.
- › Easy commissioning: intuitive interface for advanced menu settings
- › User friendly simplified remote control with contemporary design
- › For control of space heating, cooling and domestic hot water, including booster mode
- › Easy to use: all main functions directly accessible
- › The simplified user interface can only be used in combination with the main user interface
- › Use of universal symbols, no text

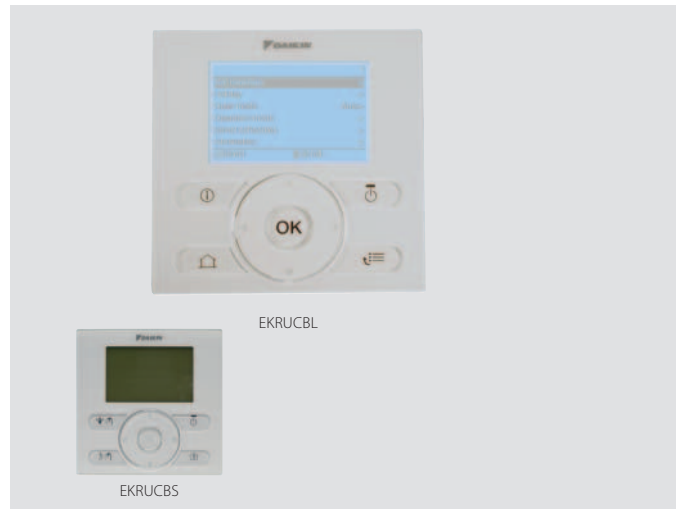

Indoor unit	EKRUCBL/EKRUCBS	1	2	3	4	5	6	7	EKRUCBS
Control systems	Class of temperature control					VI			
	Contribution to seasonal space heating efficiency					4.0			

EKRTR/EKRTW

Remote control

Room thermostat for easy regulation of the indoor temperature

- › Easy and convenient regulation of the indoor temperature, resulting in ideal comfort and energy efficiency
- › Heating and cooling mode, with possibility to disable cooling mode if not required
- › Comfort function mode activates the programmed temperature levels intended for a home occupied during the day; default setpoints are 21°C in heating mode and 24°C in cooling mode and can be changed by the user
- › Reduced function mode activates the programmed temperature levels for periods when the house is unoccupied or at night; default setpoints are 17°C in heating, 28°C in cooling mode and can be changed by the user
- › Scheduled function mode: uses a timer to schedule heating and cooling setpoints throughout the day; up to 12 setpoints can be programmed per day; the selected setpoints will be automatically activated at the scheduled time
- › Holiday function mode: intended for setting reduced and fuel-efficient setpoints when the house is unoccupied for long periods. The default setpoints are 14°C for heating and 30°C for cooling.
- › Off function: switches the system off; however, the integrated frost protection remains activated (set by default at 4°C).
- › Setpoint limitation sets the upper and lower setpoint limits within which the user can programme the desired comfort levels and can only be modified by the installer
- › Number of setpoint changes: 12/day
- › Key lock function: possible to lock the keys of the room thermostat

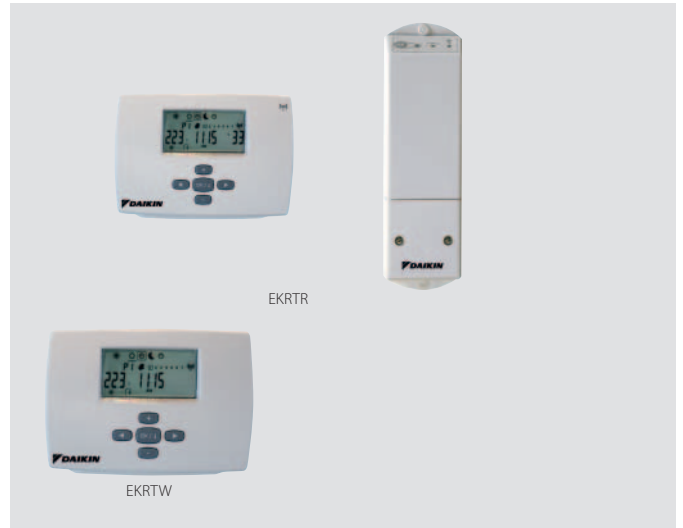

		EKRTR		EKRTWA	
Dimensions	Unit	HeightxWidthxDepth	mm	-x-x-	87x125x34
	Thermostat	Height/Width/Depth	mm	87/125/34	-/-/-
	Receiver	Height/Width/Depth	mm	170/50/28	-/-/-
Weight	Unit		g	-	215
	Thermostat		g	210	-
	Receiver		g	125	-
Ambient temperature	Storage	Min./Max.	°C		-20/60
	Operation	Min./Max.	°C		0/50
Temperature setting range	Heating	Min./Max.	°C		4/37
	Cooling	Min./Max.	°C		4/37
Clock					Yes
Regulation function				Proportional band	
Power supply	Voltage		V	-	Battery powered 3* AA-LR6 (alkaline)
	Thermostat	Voltage	V	Battery powered 3x AA-LRG (alkaline)	
	Receiver	Voltage	V	230	-
	Frequency		Hz	50	-
	Phase			1~	-
Connection	Type				Wired
	Thermostat			Wireless	-
	Receiver			Wired	-
Maximum distance to receiver	Indoor		m	approx. 30m	-
	Outdoor		m	approx. 100m	-
Control systems	Class of temperature control				IV
	Contribution to seasonal space heating efficiency		%		2.0

Heat pump convector

Floor standing unit saving on running costs when combined with under floor heating thanks to its low leaving water temperatures

- › Vertical auto swing moves the discharge flaps up and down for efficient air and temperature distribution throughout the room
- › Energy efficient heating and cooling system based on air source heat pump technology
- › Optimum energy efficiency when connected to a Daikin Altherma low temperature system
- › The indoor unit distributes air at the sound of a whisper. The noise produced amounts to barely 22dB(A) in cooling and 19dB(A) in radiant heat mode. In comparison, the ambient sound in a quiet room amounts to 40dB(A) on average.
- › Reduced running costs
- › Its low height enables the unit to fit perfectly beneath a window
- › Weekly timer can be set to start heating or cooling anytime on a daily or weekly basis
- › Indoor unit silent operation: „silent“ button on the remote control lowers the operation sound of the indoor unit by 3dB(A)
- › Can be installed against a wall or recessed
- › Powerful mode can be selected for rapid cooling; after the powerful mode is turned off, the unit returns to the preset mode.
- › Titanium apatite photocatalytic air purification filter removes airborne microscopic particles, powerfully decomposes odours and helps to prevent the propagation of bacteria, viruses, microbes to ensure a steady supply of clean air

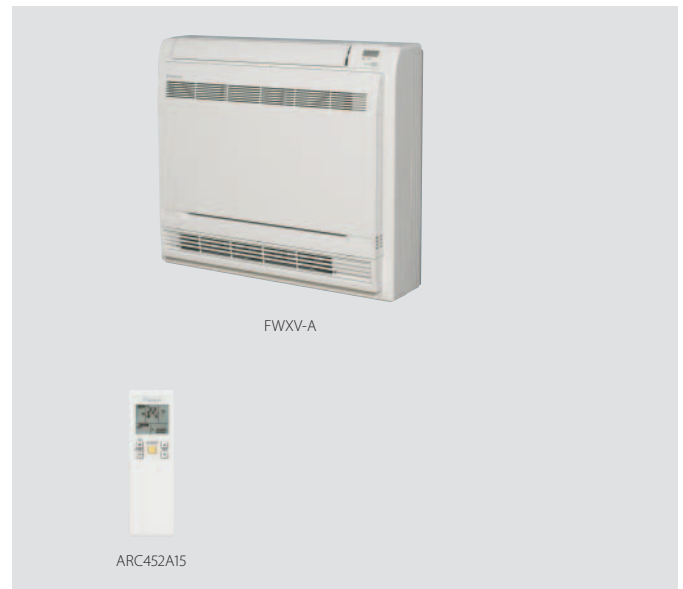

Indoor Unit			FWXV	15A	20A
Heating capacity	Total capacity	Nom.	kW	1.5	2.0
			Btu/h	5,100	6,800
Cooling capacity	Total capacity	Nom.	kW	1.2	1.7
	Sensible capacity	Nom.	kW	0.98	1.4
Power input	Heating	Nom.	kW	0.013	0.015
	Cooling	Nom.	kW	0.013	0.015
Dimensions	Unit	HeightxWidthxDepth	mm	600x700x210	
Weight	Unit		kg	15	
Piping connections	Drain/OD/Inlet		mm/inch	18/G 1/2/G 1/2	
Sound pressure level	Heating	Nom.	dBA	19	29
	Cooling	Nom.	dBA	19	29
Power supply	Phase/Frequency/Voltage		Hz/V	1~/50/60/220-240/220	

Heating & domestic hot water for renovations



Why choose Daikin Altherma high temperature?

Daikin Altherma high temperature is ideal **to replace a current oil boiler**, without replacing your existing radiators.

It offers a wide range to adapt to your customer's needs.

- Heating and domestic hot water with optional solar connection
- Capacities from 11 to 16 kW
- Combinable with existing high temperature radiators
- Easy control

Energy efficient solution when replacing an oil boiler

- › Low running costs and optimum comfort at even the coldest outdoor temperatures, thanks to the unique cascade compressor approach
- › No need to change existing radiators and piping as water temperatures can be increased up to 80°C for heating and domestic hot water use
- › Only limited installation space needed as the indoor unit and domestic hot water tank can be stacked on each other

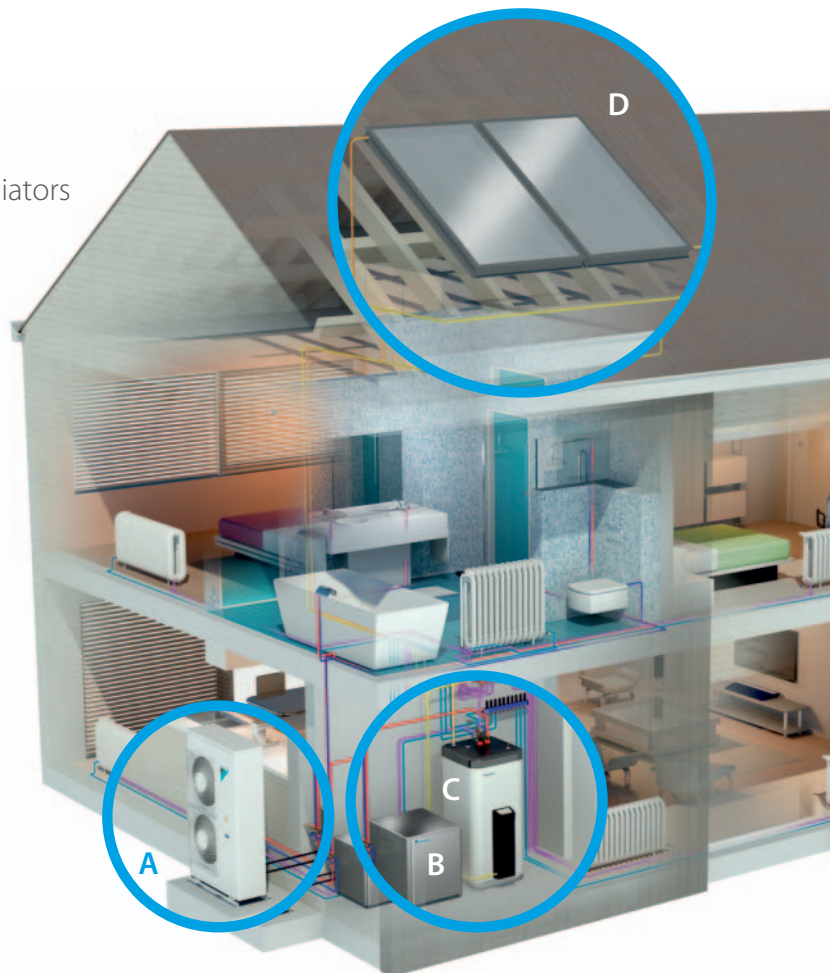

- A** Outdoor unit
- B** Indoor unit
- C** Domestic hot water tank
- D** Optional solar connection

User interface

With Daikin Altherma's user interface, the ideal temperature can be easily, quickly and conveniently regulated. It allows for more precise measurement and can regulate your comfort even more optimally and energy efficiently.

Heat emitters

The Daikin Altherma high temperature system is designed to work only with high-temperature radiators, which come in various sizes and formats to suit the interior design as well as the heating requirement. Our radiators can be individually controlled or they can be regulated by the central heating control programme.

Solar connection

The Daikin Altherma high temperature heating system can optionally use solar energy for hot water production.

If the solar energy is not required immediately, the purpose-built hot water tank (EKHWP) can store large quantities of heated water for up to a day for later use as domestic hot water or for heating.

Supporting tools

Extranet

- › Experience our new business portal at my.daikin.eu
- › Find information easily
- › Access via mobile or desktop
- › Customise the options so you see only info relevant for you

Internet

- › Find our solutions for different applications on www.daikineurope.com/for-your-home/needs/heating/air-water-heatpumps-ht/

Literature

- › See all the literature available on www.daikineurope.com/support-and-manuals/catalogues

Software

- › Calculate your energy savings: <http://ecocalc.daikin.eu/>



Daikin Altherma high temperature split

Floor standing heating only air to water heat pump combinable with existing radiators

- › Energy efficient heating only system based on air to water heat pump technology
- › High temperature application: up to 80°C without electric heater
- › Easy replacement of existing boiler, without changing heating pipes
- › Combinable with high temperature radiators
- › Low energy bills and low CO₂ emissions
- › Inverter controlled scroll compressor
- › Outdoor unit extracts heat from the outdoor air, even at -20°C



Efficiency data		EKHBRD + ERSQ/ERRQ		011ADV1 + 011AV1	014ADV1 + 014AV1	016ADV1 + 016AV1	011ADY1 + 011AY1	014ADY1 + 014AY1	016ADY1 + 016AY1	
Heating capacity	Nom.			kW	11.00 (1) / 11.00 (2) / 11.00 (3) / 11.20 (3)	14.00 (1) / 14.00 (2) / 14.00 (3) / 14.40 (3)	16.00 (1) / 16.00 (2) / 16.00 (3)	11.00 (1) / 11.00 (2) / 11.00 (3) / 11.20 (3)	14.00 (1) / 14.00 (2) / 14.00 (3) / 14.40 (3)	16.00 (1) / 16.00 (2) / 16.00 (3)
Power input	Heating	Nom.		kW	3.57 (1) / 4.40 (2) / 2.61 (3) / 2.67 (3)	4.66 (1) / 5.65 (2) / 3.55 (3) / 3.87 (3)	5.57 (1) / 6.65 (2) / 4.31 (3)	3.57 (1) / 4.40 (2) / 2.61 (3) / 2.67 (3)	4.66 (1) / 5.65 (2) / 3.55 (3) / 3.87 (3)	5.57 (1) / 6.65 (2) / 4.31 (3)
Domestic hot water heating	General	Declared load profile			-					
	Average climate	η_{wh} (water heating efficiency)		%	-					
		Water heating energy efficiency class			-					
Space heating	Average climate water outlet 55°C	General	SCOP		2.65	2.66	2.61	2.65	2.66	2.61
			η_s (Seasonal space heating efficiency)	%	103	104	102	103	104	102
			Seasonal space heating eff. class		A+					
	Average climate water outlet 35°C	General	SCOP		2.70	2.68	2.88	2.70	2.68	2.88
		η_s (Seasonal space heating efficiency)	%	105	110	112	105	110	112	
		Seasonal space heating eff. class		B						

Indoor Unit		EKHBRD		011ADV1	014ADV1	016ADV1	011ADY1	014ADY1	016ADY1
Casing	Colour	Metallic grey							
	Material	Precoated sheet metal							
Dimensions	Unit	HeightxWidthxDp		mm					
		705x600x695							
Weight	Unit			144		147			
Operation range	Heating	Ambient	Min.~Max.	°C					
		Water side	Min.~Max.	°C					
	Domestic hot water	Ambient	Min.~Max.	°CDB					
		Water side	Min.~Max.	°C					
Refrigerant	Type	R-134a							
	Charge			kg					
				TCO ₂ eq					
				GWP					
Sound pressure level	Nom.			43 / 46	45 / 46	46 / 46	43 / 46	45 / 46	46 / 46
	Night quiet mode	Level 1		40	43	45	40	43	45

Outdoor Unit		ERSQ/ERRQ		011AV1	014AV1	016AV1	011AY1	014AY1	016AY1
Dimensions	Unit	HeightxWidthxDp		mm					
		1,345x900x320							
Weight	Unit			kg					
		120							
Compressor	Quantity	1							
	Type	Hermetically sealed scroll compressor							
Operation range	Heating	Min.~Max.		°CWB					
	Domestic hot water	Min.~Max.		°CDB					
Refrigerant	Type	R-410A							
	Charge			kg					
				TCO ₂ eq					
				GWP					
	Control	Expansion valve (electronic type)							
Sound power level	Heating	Nom.		68	69	71	68	69	71
Sound pressure level	Heating	Nom.		52	53	55	52	53	55
Power supply	Name/Phase/Frequency/Voltage			V1/1~/50/220-440			Y1/3~/50/380-415		
Current	Recommended fuses			A			16		

(1) EW 55°C; LW 65°C; Dt 10°C; ambient conditions: 7°CDB/6°CWB (2) EW 70°C; LW 80°C; Dt 10°C; ambient conditions: 7°CDB/6°CWB (3) EW 30°C; LW 35°C; Dt 5°C; ambient conditions: 7°CDB/6°CWB (4) Contains fluorinated greenhouse gases

Domestic hot water tank

Stackable stainless steel domestic hot water tank

- › Stainless steel domestic hot water tank
- › The indoor unit and domestic hot water tank can be stacked to save space, or installed next to each other, if only limited height is available
- › Available in 200 and 260 liters
- › Heat loss is reduced to a minimum thanks to the high quality insulation
- › At necessary intervals, the indoor unit can heat up the water to 60°C to prevent the risk of bacteria growth
- › Efficient temperature heat-up: from 10°C to 50°C in only 60 minutes

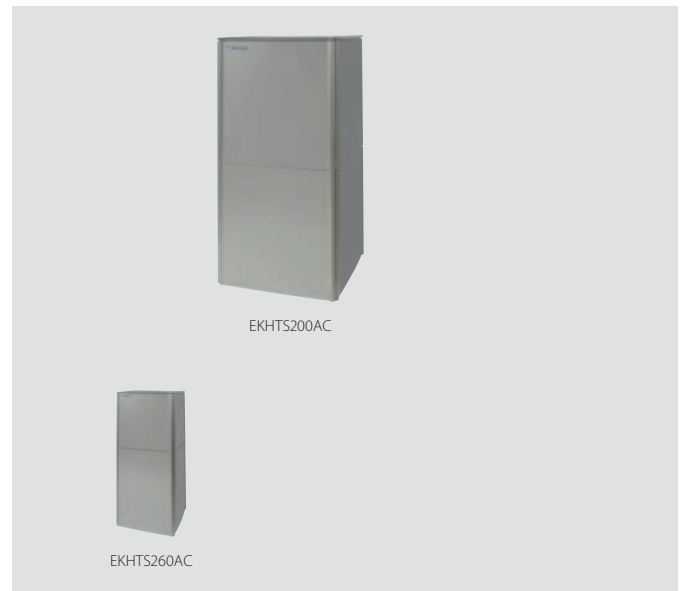

Accessory				EKHTS	200AC	260AC
Casing	Colour	Metallic grey				
	Material	Galvanised steel (precoated sheet metal)				
Dimensions	Unit	Height	Integrated on indoor unit	mm	2,010	2,285
		Width			600	
	Depth	695				
Weight	Unit	Empty		kg	70	78
	Water volume			l	200	260
Tank	Material	Stainless steel (EN 1.4521)				
	Maximum water temperature			°C	75	
	Insulation	Heat loss		kWh/24h	12.0	15.0
	Energy efficiency class	B				
	Standing heat loss			W	50	63
	Storage volume			l	200	260
	Heat exchanger	Quantity	1			
	Tube material	Duplex steel (EN 1.4162)				
	Face area			m ²	1.560	
	Internal coil volume			l	7.5	

Domestic hot water tank

Plastic domestic hot water tank with solar support

- › Tank designed for connection with thermal solar collectors
- › Available in 300 and 500 liters
- › Large hot water storage tank to provide domestic hot water at any time
- › Heat loss is reduced to a minimum thanks to the high quality insulation
- › Space heating support possible (500l tank only)



Accessory		EKHWP	300B	500B	
Casing	Colour		Traffic white (RAL9016) / Dark grey (RAL7011)		
	Material		Impact resistant polypropylene		
Dimensions	Unit	Width	mm	790	
		Depth	mm	790	
		Empty	kg	82	
Weight	Unit		58	82	
	Tank	Water volume	l	300	
Heat exchanger	Domestic hot water	Material		Polypropylen	
		Maximum water temperature	°C	85	
	Insulation	Heat loss	kWh/24h	1.5	1.7
		Energy efficiency class			B
	Standing heat loss		W	64	72
		Storage volume	l	294	477
	Charging	Domestic hot water	Quantity		1
			Tube material		Stainless steel (DIN 1.4404)
		Face area	m ²	5.600	5.800
			Internal coil volume	l	27.1
Operating pressure		bar		6	
		Average specific thermal output	W/K	2,790	2,825
Charging		Quantity		1	
		Tube material		Stainless steel (DIN 1.4404)	
Face area		m ²	3	4	
		Internal coil volume	l	13	19
Operating pressure	bar		3		
	Average specific thermal output	W/K	1,300	1,800	
Auxiliary solar heating	Tube material			Stainless steel (DIN 1.4404)	
	Face area	m ²	-	1	
	Internal coil volume	l	-	2	
	Operating pressure	bar	-	3	
	Average specific thermal output	W/K	-	280	

EKHWP-PB

Domestic hot water tank

Pressureless domestic hot water tank with solar support

- › Tank designed for connection with pressurised thermal solar system
- › Available in 300 and 500 liters
- › Large hot water storage tank to provide domestic hot water at any time
- › Heat loss is reduced to a minimum thanks to the high quality insulation
- › Space heating support possible (500l tank only)



Accessory		EKHWP	300PB	500PB	
Casing	Colour		Traffic white (RAL9016) / Dark grey (RAL7011)		
	Material		Impact resistant polypropylene		
Dimensions	Unit	Width	mm	790	
		Depth	mm	790	
		Empty	kg	58	89
Weight	Unit		58	89	
	Tank	Water volume	l	294	
Heat exchanger	Domestic hot water	Material		Polypropylen	
		Maximum water temperature	°C	85	
	Insulation	Heat loss	kWh/24h	1.5	1.7
		Energy efficiency class			B
	Standing heat loss		W	64	72
		Storage volume	l	294	477
	Charging	Domestic hot water	Quantity		1
			Tube material		Stainless steel (DIN 1.4404)
		Face area	m ²	5.600	5.800
			Internal coil volume	l	27.1
Operating pressure		bar		6	
		Average specific thermal output	W/K	2,790	2,825
Charging		Quantity		1	
		Tube material		Stainless steel (DIN 1.4404)	
Face area		m ²	3	4	
		Internal coil volume	l	13	19
Operating pressure	bar		3		
	Average specific thermal output	W/K	1,300	1,800	
Auxiliary solar heating	Tube material			Stainless steel (DIN 1.4404)	
	Face area	m ²	-	1	
	Internal coil volume	l	-	2	
	Operating pressure	bar	-	3	
	Average specific thermal output	W/K	-	280	

Solar collector

Thermal solar collector for hot water production

- › Solar collectors can produce up to 70% of the energy needed for hot water production - a major cost saving
- › Vertical and horizontal solar collectors for domestic hot water production
- › High efficiency collectors transfer all the short-wave solar radiation into heat as a result of their highly selective coating
- › Easy to install on roof tiles

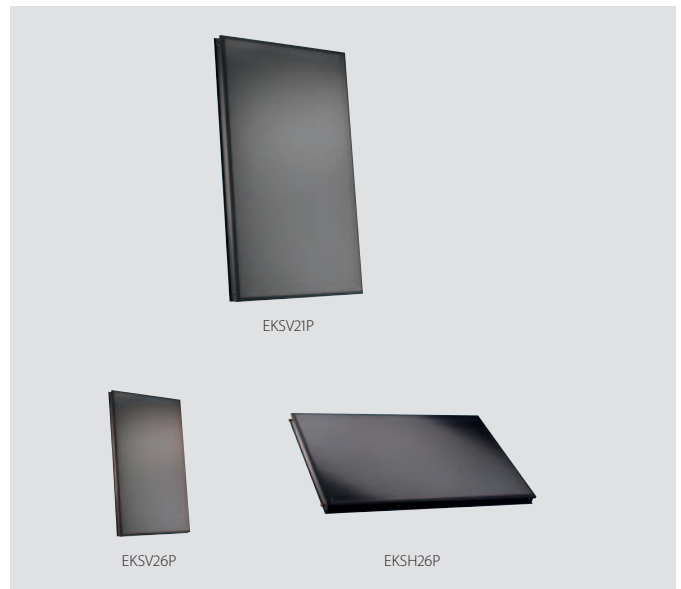

Solar collector				EKS21P	EKS26P	EKSH26P
Mounting				Vertical		Horizontal
Dimensions	Unit	HeightxWidthxDepth	mm	1,006x85x2,000		2,000x85x1,300
Weight	Unit		kg	33		42
Volume			l	1.3	1.7	2.1
Surface	Outer		m ²	2.01		2.60
	Aperture		m ²	1.800		2.360
	Absorber		m ²	1.79		2.35
Coating				Micro-therm (absorption max. 96%, Emission ca. 5% +/-2%)		
Absorber				Harp-shaped copper pipe register with laser-welded highly selective coated aluminium plate		
Glazing				Single pane safety glass, transmission +/- 92%		
Allowed roof angle	Min.~Max.		°	15~80		
Operating pressure	Max.		bar	6		
Stand still temperature	Max.		°C	192		
Thermal performance	collector efficiency (η _{col})		%	61		
	Zero loss collector efficiency η ₀		%	0.781		0.784
	Heat loss coefficient a ₁		W/m ² .K	4.240		4.250
	Temperature dependence of the heat loss coefficient a ₂		W/m ² .K ²	0.006		0.007
	Thermal capacity		kJ/K	4.9		6.5

EKS RPS4A

Pump station

- › Save energy and reduce CO₂ emissions with a solar system for domestic hot water production
- › Pump station connectable to unpressurised solar system
- › Pump station and control provide the transfer of solar heat to the domestic hot water tank



Pump station for pressureless tank				EKS RPS	EKS RPS4A
Dimensions	Unit	HeightxWidthxDepth	mm		815x142x230
Weight	Unit		kg		6
Power supply	Phase				1~
	Frequency		Hz		50
	Voltage		V		230

Daikin Altherma Flex Type

for large residential and commercial applications

Why choose Daikin Altherma Flex Type

Daikin Altherma Flex Type is a flexible solution for space heating, domestic hot water and cooling for e.g. apartments, spas, hotels and restaurants

- Low operating costs thanks to high efficiency
- Large hot water volume
- Cooling in the most efficient way thanks to heat recovery technology
- Limited installation space thanks to small footprint of indoor unit and outdoor unit

Heat emitters

All types of heat emitters can be connected thanks to its wide water temperature range (up to 80°C) and its ability to work with multiple set points, allowing a combination of different heat emitters operating at different water temperatures.

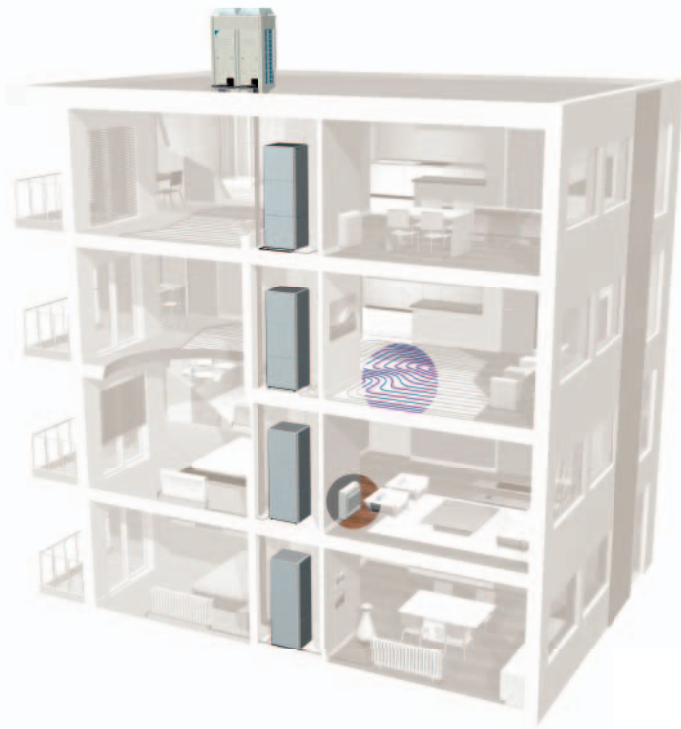

Modular system

One or more outdoor units can be connected to several indoor units (maximum 10 indoor units per outdoor unit).

Advanced control and monitoring

To further increase the efficiency, an RTD-W per indoor unit and a sequencing controller for the full heating system can be installed to monitor the exact heating demand.

- 1 Heating
- 2 Cooling
- 3 Hot water

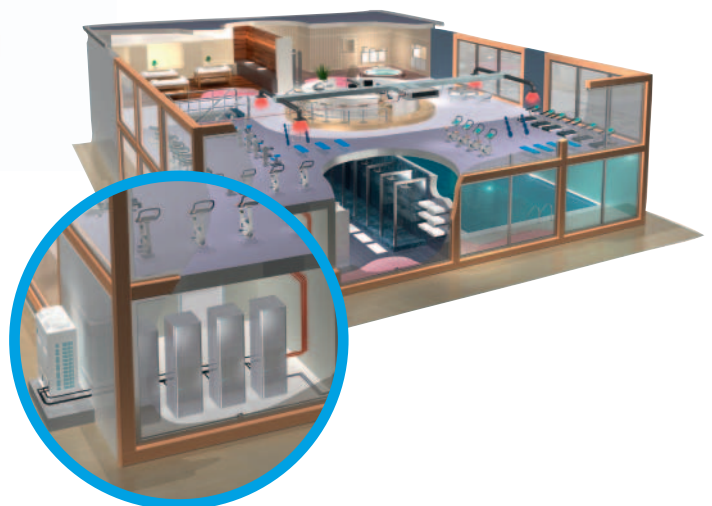

Supporting tools

Extranet

- › Experience our new business portal at my.daikin.eu
- › Find information easily

Literature

- › See all the literature available on www.daikineurope.com/support-and-manuals/catalogues

Daikin Altherma Flex Type

Floor standing reversible air to water heat pump for large residential and commercial applications

- › Floor standing indoor unit up to 9kW
- › Low energy bills and low CO₂ emissions
- › Energy efficient heating only system based on air to water heat pump technology
- › High temperature application: up to 80°C without electric heater
- › Flexible configuration with respect to heat emitters
- › Inverter controlled scroll compressor



EKHVM(R/Y)D-AB

Indoor Unit		EKHVMRD/EKHVMYD		50AB	80AB	50AB	80AB
Dimensions	Unit	Height	mm			705	
		Width	mm			600	
		Depth	mm			695	
Weight	Unit		kg	92			120
Operation range	Heating	Ambient	Min.~Max.			-15~20	
		Water side	Min.~Max.	°C		25~80	
	Cooling	Ambient	Min.~Max.	°CDB	---		10~43
		Water side	Min.~Max.	°C	---		5~20
	Domestic hot water	Ambient	Min.~Max.	°CDB			-15~35
		Water side	Min.~Max.	°C			45~75
Refrigerant	Type					R-134a	
	Charge		kg			2	

Contains fluorinated greenhouse gases

Daikin Altherma Flex Type

Floor standing heating only air to water heat pump combinable with existing radiators

- › Energy efficient heating only system based on air to water heat pump technology
- › High temperature application: up to 80°C without electric heater
- › Easy replacement of existing boiler, without changing heating pipes
- › Combinable with high temperature radiators
- › Low energy bills and low CO₂ emissions
- › Inverter controlled scroll compressor



EKHBRD-ADV1/Y1

Indoor Unit		EKHBRD	011ADV1	014ADV1	016ADV1	011ADY1	014ADY1	016ADY1
Dimensions	Unit	Height	mm			705		
		Width	mm			600		
		Depth	mm			695		
Weight	Unit	kg		144			147	
Operation range	Heating	Ambient	Min.~Max.		-			
		Water side	Min.~Max.		°C 25~80			
	Domestic hot water	Ambient	Min.~Max.		°CDB -20~35			
		Water side	Min.~Max.		°C 25~80			
Refrigerant	Type				R-134a			
	Charge	kg		2.6				
		TCO ₂ eq		3.718				
	Control				-			
	GWP				1,430			

Daikin Altherma Flex Type

- › Low energy bills and low CO₂ emissions
- › Easy installation and maintenance
- › Integrated heat recovery system
- › The ultimate heating solution for residential and commercial applications based on air to water heat pump technology
- › Customised to meet your building's needs: up to 10 indoor units can be connected to 1 outdoor unit



EMRQ-A

Outdoor Unit				EMRQ	8A (1)	10A (2)	12A (3)	14A (4)	16A (5)	
Heating capacity	Nom.			kW	22.4 (6)	28 (6)	33.6 (6)	39.2 (6)	44.8 (6)	
Cooling capacity	Nom.			kW	20 (7)	25 (7)	30 (7)	35 (7)	40 (7)	
Seasonal efficiency	Domestic hot water heating	General	Declared load profile		XL					
		Average climate	η_{wh} (water heating efficiency) %		93		83.7		93	
	Average climate water outlet 55°C	General	Water heating energy efficiency class		A					
			η_s (Seasonal space heating efficiency) %		108	104	103	106	103	
		SCOP		2.78	2.68	2.64	2.74	2.64		
		Seasonal space heating eff. Class		A+						
Casing	Colour	Daikin White								
	Material	Painted galvanized steel plate								
Dimensions	Unit	HeightxWidthxDepth	mm	1,680x1,300x765						
Weight	Unit		kg	331			339			
Operation range	Heating	Min.	°CWB	-15						
		Max.	°CWB	20						
	Domestic hot water	Ambient	Min.-Max.	°CDB	-15~35					
		Cooling	Min.	°CDB	10					
		Max.	°CDB	43						
Refrigerant	Type / GWP	R-410A / 2,087.5								
	Charge		kg	10.3	10.6	10.8	11.1			
	Charge		TCO ₂ Eq	21.5	22.1	22.5	23.2			
Piping connections	Liquid	OD	mm	9.52		12.7		13		12.7
	Suction	OD	mm	19.1		22.2		28.6		
	High and low pressure gas	OD	mm	15.9		19.1		22.2		
		OU - IU	Max.	m	100					
		System	Equivalent	m	120					
	Total piping length	System	Actual	300						
Sound power level	Heating	Nom.	dBA	78		80		83		84
Sound pressure level	Heating	Nom.	dBA	58		60		62		63
Power supply	Phase/Voltage	V								
		3~/380-415								
Current	Recommended fuses	A		20	25		40			

(1) 100% connection ratio of EMRQ8A / 4x EKHVMD50AB / 4x EKHTS260AC (2) 100% connection ratio of EMRQ10A / 2x EKHBRD014AD / 2x EKHTS260AC (3) 100% connection ratio of EMRQ12A / 2x EKHBRD016AD / 2x EKHTS260AC (4) 100% connection ratio of EMRQ14A / 7x EKHVMD50AB / 7x EKHTS260AC (5) 100% connection ratio of EMRQ16A / 4x EKHBRD016AD / 4x EKHTS260AC (6) Condition: Ta=7°CDB/6°CWB, 100% connection ratio (7) Condition: Ta=35°CDB, 100% connection ratio (8) Contains fluorinated greenhouse gases

Domestic hot water tank

Plastic domestic hot water tank with solar support

- › Tank designed for connection with thermal solar collectors
- › Available in 300 and 500 liters
- › Large hot water storage tank to provide domestic hot water at any time
- › Heat loss is reduced to a minimum thanks to the high quality insulation
- › Space heating support possible (500l tank only)



Accessory	EKHP			300B	500B
Casing	Colour	Traffic white (RAL9016) / Dark grey (RAL7011)			
	Material	Impact resistant polypropylene			
Dimensions	Unit	Width	mm	595	790
		Depth	mm	615	790
		Empty	kg	58	82
Weight Tank	Water volume		l	300	500
	Material	Polypropylen			
	Maximum water temperature		°C	85	
	Insulation	Heat loss	kWh/24h	1.5	1.7
	Energy efficiency class	B			
	Standing heat loss		W	64	72
	Storage volume		l	294	477
	Heat exchanger	Domestic hot water	Quantity		1
		Tube material		Stainless steel (DIN 1.4404)	
		Face area	m ²	5,600	5,800
		Internal coil volume	l	27.1	29.0
		Operating pressure	bar	6	
		Average specific thermal output	W/K	2,790	2,825
	Charging	Quantity		1	
		Tube material		Stainless steel (DIN 1.4404)	
		Face area	m ²	3	4
		Internal coil volume	l	13	19
		Operating pressure	bar	3	
		Average specific thermal output	W/K	1,300	1,800
	Auxiliary solar heating	Tube material		Stainless steel (DIN 1.4404)	
		Face area	m ²	-	1
		Internal coil volume	l	-	2
		Operating pressure	bar	-	3
		Average specific thermal output	W/K	-	280

EKHTS-AC

Domestic hot water tank

Stackable stainless steel domestic hot water tank

- › Stainless steel domestic hot water tank
- › The indoor unit and domestic hot water tank can be stacked to save space, or installed next to each other, if only limited height is available
- › Available in 200 and 260 liters
- › Heat loss is reduced to a minimum thanks to the high quality insulation
- › At necessary intervals, the indoor unit can heat up the water to 60°C to prevent the risk of bacteria growth
- › Efficient temperature heat-up: from 10°C to 50°C in only 60 minutes

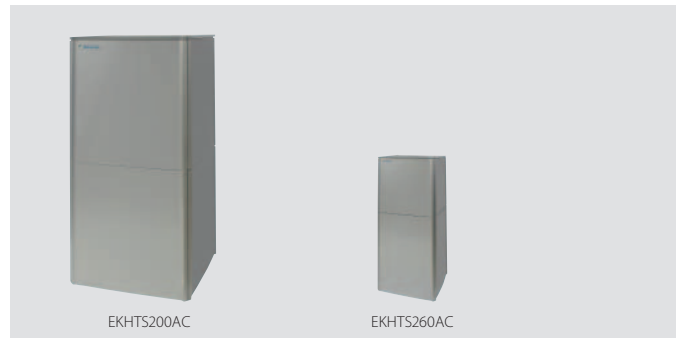

Accessory	EKHTS			200AC	260AC
Casing	Colour	Metallic grey			
	Material	Galvanised steel (precoated sheet metal)			
Dimensions	Unit	Height	Integrated on indoor unit	mm	2,010
		Width		mm	600
		Depth		mm	695
Weight Tank	Unit	Empty		kg	70
	Water volume			l	200
	Material	Stainless steel (EN 1.4521)			
	Maximum water temperature			°C	75
	Insulation	Heat loss	kWh/24h	12.0	15.0
	Energy efficiency class	B			
	Standing heat loss		W	50	63
	Storage volume		l	200	260
	Heat exchanger	Quantity			1
	Tube material			Duplex steel (EN 1.4162)	
	Face area		m ²	1,560	
	Internal coil volume		l	7.5	

Heat pump convector

Floor standing unit saving on running costs when combined with under floor heating thanks to its low leaving water temperatures

- › Vertical auto swing moves the discharge flaps up and down for efficient air and temperature distribution throughout the room
- › Energy efficient heating and cooling system based on air source heat pump technology
- › Optimum energy efficiency when connected to a Daikin Altherma low temperature system
- › The indoor unit distributes air at the sound of a whisper. The noise produced amounts to barely 22dB(A) in cooling and 19dB(A) in radiant heat mode. In comparison, the ambient sound in a quiet room amounts to 40dB(A) on average.
- › Reduced running costs
- › Its low height enables the unit to fit perfectly beneath a window
- › Weekly timer can be set to start heating or cooling anytime on a daily or weekly basis
- › Indoor unit silent operation: „silent“ button on the remote control lowers the operation sound of the indoor unit by 3dBA
- › Can be installed against a wall or recessed
- › Powerful mode can be selected for rapid cooling; after the powerful mode is turned off, the unit returns to the preset mode.
- › Titanium apatite photocatalytic air purification filter removes airborne microscopic particles, powerfully decomposes odours and helps to prevent the propagation of bacteria, viruses, microbes to ensure a steady supply of clean air

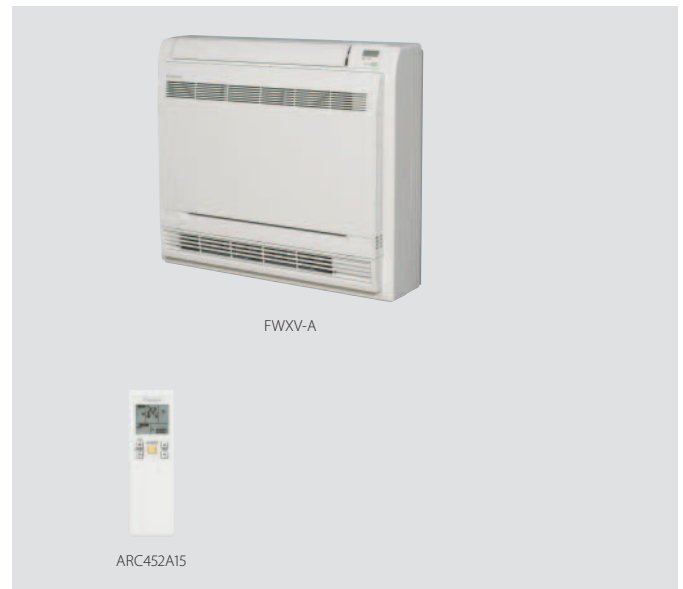

Indoor Unit			FWXV	15A	20A
Heating capacity	Total capacity	Nom.	kW	1.5	2.0
			Btu/h	5,100	6,800
Cooling capacity	Total capacity	Nom.	kW	1.2	1.7
	Sensible capacity	Nom.	kW	0.98	1.4
Power input	Heating	Nom.	kW	0.013	0.015
	Cooling	Nom.	kW	0.013	0.015
Dimensions	Unit	HeightxWidthxDepth	mm	600x700x210	
Weight	Unit		kg	15	
Piping connections	Drain/OD/Inlet		mm/inch	18/G 1/2/G 1/2	
Sound pressure level	Heating	Nom.	dBA	19	29
	Cooling	Nom.	dBA	19	29
Power supply	Phase/Frequency/Voltage		Hz/V	1~/50/60/220-240/220	

Domestic hot water heat pump

Hot water in an efficient way

Why choose the domestic hot water heat pump?

- Domestic hot water is heated almost immediately
- Combine it with solar heating for even better energy efficiency
- Easy installation: no water tank pressure and only limited pressure in the heat exchanger
- Low maintenance: no anode means no scale and lime deposits or corrosion
- Electrical back-up (2.5 kW) ensures hot water under all circumstances. The 500L tank can also be equipped with an external hydraulic back-up.

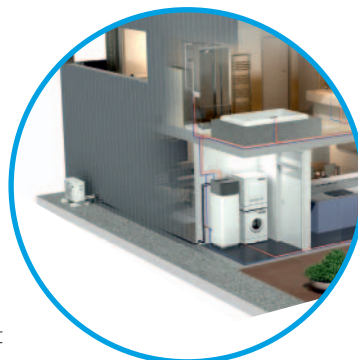
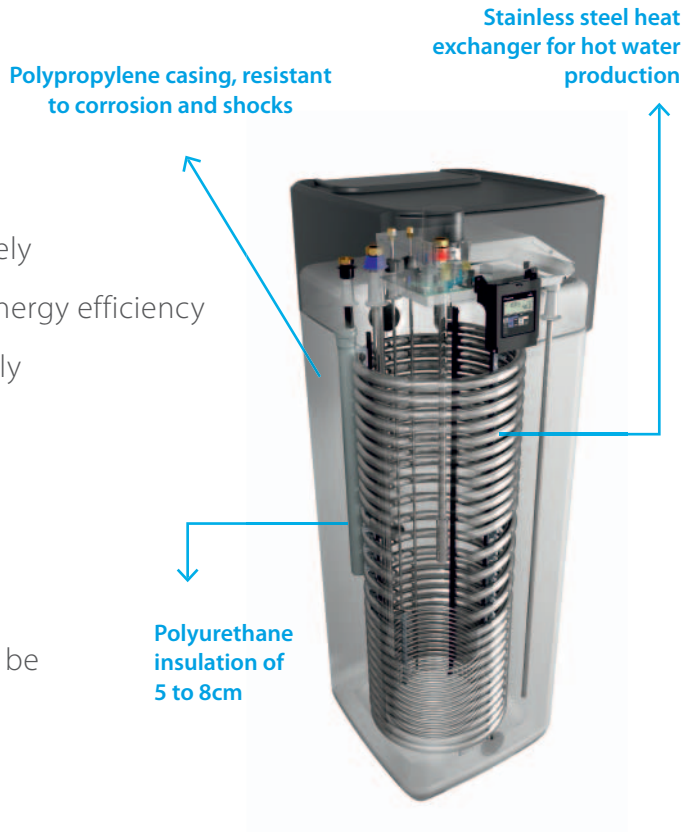

How does it work?

The outdoor unit extracts (pumps) heat from the air. Through a heat exchanger this heat is transferred directly to the storage tank – for hot water almost immediately.

High performance inverter heat pump

Just using the heat pump, hot water can be provided up to 55°C and hot water production is guaranteed down to -15°C.

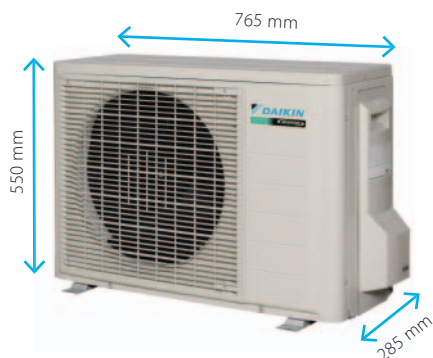

Solar connection

For even more energy efficiency the heat pump can be combined with solar collectors. Two technologies are possible:

Pressureless (drain-back)

The solar collectors are only filled with water when the sun provides enough heat. In this case, both pumps in the control and pump unit switch on briefly and fill the collectors with storage tank water. After filling, one switches off and the other maintains water circulation. If there is not enough sunshine or if the solar storage tank doesn't need more heat, the circulation pump switches off and the entire solar system drains into the storage tank.

Pressurised

This system uses heat transfer fluid containing antifreeze to avoid freezing in winter. The whole system is pressurised and sealed.

Domestic hot water heat pump

Hot water in an efficient way

- › Domestic hot water is heated almost immediately
- › Combine it with solar heating for even better energy efficiency
- › Easy installation: no water tank pressure and only limited pressure in the heat exchanger
- › Low maintenance: no anode means no scale and lime deposits or corrosion
- › Electrical back-up (2.5 kW) ensures hot water under all circumstances. The 500L tank can also be equipped with an external hydraulic back-up.



Efficiency data		EKHHP + ERWQ		300A2V3 + 02AV3	500A2V3 + 02AV3
Domestic hot water heating	General	Declared load profile		L	XL
	Average climate	η_{wh} (water heating efficiency)	%	119	123
		Water heating energy efficiency class		A	
Indoor Unit		EKHHP		300A2V3	500A2V3
Casing	Colour	Traffic white (RAL9016) / Dark grey (RAL7011)			
Dimensions	Unit	HeightxWidthxDepth	mm	1,750x615x615	1,750x790x790
Weight	Unit		kg	70	80
Tank	Water volume		l	294	477
	Maximum water temperature		°C		85
	Maximum water pressure		bar		0
Operation range	Domestic hot water	Water side Min.~Max.	°C	5~75	
Sound power level	Nom.		dBA	0	
Sound pressure level	Nom.		dBA	0	
Outdoor Unit		ERWQ		02AV3	
Dimensions	Unit	HeightxWidthxDepth	mm	612x906x402	
Weight	Unit		kg	35	
Compressor	Quantity			1	
	Type			Hermetically sealed swing compressor	
Operation range	Domestic hot water	Min.~Max.	°CDB	-15~35	
Refrigerant	Type			R-410A	
	Charge		kg	1,05	
	GWP			2,087.5	
Sound pressure level	Nom.		dBA	47	
	Min.		dBA	44	
Power supply	Name/Phase/Frequency/Voltage		Hz/V	V3/1~/50/230	

Contains fluorinated greenhouse gases

Gas condensing boiler

Reliability and peace of mind

Why choose the Daikin gas condensing boiler?

- Low costs for both heating and hot water thanks to new dual heat exchanger resulting in high efficiencies
- Easy installation in minimum space

Gas condensing boiler

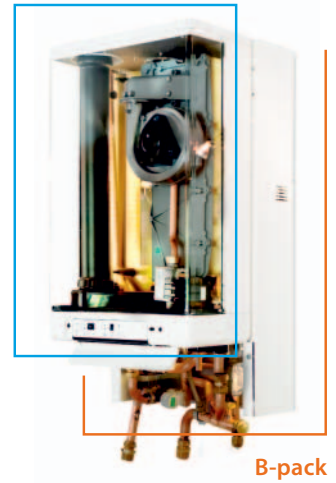

Low costs for both heating and hot water thanks to new dual heat exchanger

1. With the first heat exchanger, maximum efficiency is reached when heating your home through condensation of the flue gases.

[Unique Daikin feature]

2. Also when producing hot water the efficiency is maximised thanks to condensation with the unique second heat exchanger.

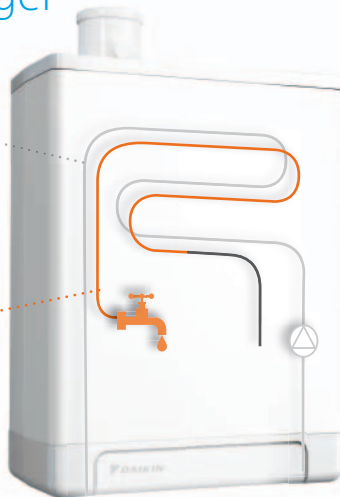

Unique in the market: double condensation, not only for heating but also for domestic hot water resulting in low running costs

Easy installation in minimum space

Installation time can be reduced to the minimum by using our optional pre-assembled B-pack which contains all the components for the functional installation in one module and fits behind the boiler. And as there are fewer parts, the Daikin condensing gas boiler is more reliable and easier to service.

Control at a distance

Program your gas condensing boiler and follow up your energy consumption from a smartphone, tablet or computer with the RTRNETA3AA controller.



Supporting tools

Extranet

- › Experience our new business portal at my.daikin.eu
- › Find information easily
- › Access via mobile or desktop
- › Customise the options so you see only info relevant for you

Internet

- › Find our solutions for different applications on www.daikineurope.com/for-your-home/needs/heating/condensing-boilers/

Literature

- › See all the literature available on www.daikineurope.com/support-and-manuals/catalogues

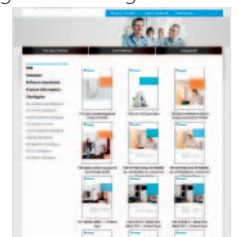

Gas condensing boiler

High efficiency gas condensing boiler for heating and hot water

- › High efficiency gas condensing boiler
- › Low running costs for both heating and hot water thanks to new dual heat exchanger
- › Maximum heating comfort and domestic hot water when it is most needed
- › Quick, easy and compact installation thanks to our optional pre-assembled B-pack, containing all auxiliary components



Indoor Unit		EKOMB/EKOMBG		22AH	28AH	33AH	22A	28A	33A	
Gas	Connection	Diameter	mm	15		-	15			
	Consumption (G20)	Min-Max	m ³ /h	0.58-2.29	0.74-2.46	---	0.57-2.42	0.75-3.02	0.78-3.39	
	Consumption (G25)	Min-Max	m ³ /h	---			0.66-2.80	0.86-3.50	0.80-3.93	
	Consumption (G31)	Min-Max	m ³ /h	0.22-0.87	---		0.22-0.92	0.28-1.15	0.30-1.29	
Central heating	Heat input Qn (net calorific value)	Nom	Min-Max	kW	5.6-18.7	7.1-23.7	7.2-27.3	5.5-23.3	7.2-29.1	7.5-32.7
	Heat input Qn (gross calorific value)	Nom	Min-Max	kW	6.2-20.8	7.9-26.3	8.0-30.3	6.1-25.9	8.0-32.3	8.3-36.3
	Output Pn at 80/60°C	Min-Nom		kW	--17.8	--22.8	7.1-26.3	5.4-22.7	7.1-28.4	7.4-32.1
	Output Pnc at 50/30°C	Min-Nom		kW	---		7.8-27.1	5.9-23.8	7.7-31.1	8.2-35.0
	Output at 40/30°C	Min		kW	-		7.7	5.9	7.7	8.2
	Water pressure (PMS)	Max		bar	3	-		3		
	Water temperature	Max		°C	-			90		
	Efficiency	Net calorific value		%	107					109
Domestic hot water	Operation range	Min/Max		°C						
	Heat input (net calorific value) Qnw	Nom	Min-Max	kW	5.6-22.1	7.1-28.0	---	5.5-23.3	7.2-29.1	7.5-32.7
	Heat input (gross calorific value) Qnw	Nom	Min-Max	kW	6.2-24.6	7.9-31.1	---	6.1-25.9	8.0-32.3	8.3-36.3
	Output	Min-Nom		kW	---			5.9-22.7	7.7-28.4	8.2-32.1
	Domestic hot water threshold			l/min	1.5		-	1.5		
	Water flow	Rate	Nom	l/min	10.0 / 6.0	12.5 / 7.5	-	10.0 / 6.0	12.5 / 7.5	15.0 / 9.0
	Temperature	Factory setting		°C	60					
	Operation range	Min/Max		°C	40/65			-/-		
Supply air	Connection		mm	100		-	100			
	Concentric			-			Yes			
Flue gas	Connection		mm	60	-		60			
Casing	Colour			White - RAL9010		-	White - RAL9010			
	Material			Precoated sheet metal		-	Precoated sheet metal			
Dimensions	Unit	HeightxCasingxIntegrated on indoor unitxWidth	mm	590x-x450x240	650x-x450x240	-	590x-x450x240	650x-x450x240	710x-x450x240	
Weight	Unit	Empty	kg	30	33	-	30	33	36	
Power supply	Phase/Frequency/Voltage		Hz/V	1~/50/230						
Electrical power consumption	Max.		W	80						
	Standby		W	2						
Domestic hot water heating	General	Declared load profile		L	XL		L	XL		
		η _{wh} (water heating efficiency)	%	84	87		84	87		
		Water heating energy efficiency class		A						
Space heating	General	η _s (Seasonal space heating efficiency)	%	93					94	
		Seasonal space heating eff. class		A						

Options - Heating

Daikin Altherma hybrid heat pump	
Remote user interface (DE, FR, NL, IT)	EKRUCBL1
Remote user interface (EN, SV, NO, FI)	EKRUCBL2
Remote user interface (EN, ES, EL, PT)	EKRUCBL3
Remote user interface (EN, TR, PL, RO)	EKRUCBL4
Remote user interface (DE, CS, SL, SK)	EKRUCBL5
Remote user interface (EN, HR, HU, BG)	EKRUCBL6
Remote user interface (EN, DE, RU, DA)	EKRUCBL7
Propane set	EKHY075787
Concentric connection Ø 80/125	EKHY090717
Eccentric connection Ø 80	EKHY090707
Cover plate 35	EKHY093467
Installation jig	EKHVMNT1
Drain pan for reversible H/B	EKHYPD1
Thermistor recirculator	EKTH2
Roof Terminal PP/GLV 60/100 AR460	EKFGP6837
Weather Slate Steep Pb/GLV 60/100 18°-22°	EKFGS0518
Weather Slate Steep Pb/GLV 60/100 23°-27°	EKFGS0519
Weather Slate Steep Pf 60/100 25°-45°	EKFGP7910
Weather Slate Steep Pb/GLV 60/100 43°-47°	EKFGS0523
Weather Slate Steep Pb/GLV 60/100 48°-52°	EKFGS0524
Weather Slate Steep Pb/GLV 60/100 53°-57°	EKFGS0525
Weather Slate Flat Alu 60/100 0°-15°	EKFGP1296
Weather Slate Flat Alu 60/100	EKFGP6940
Wall Terminal Kit PP/GLV 60/100	EKFGP2978
Wall Terminal Kit low profile PP/GLV 60/100	EKFGP2977
Extension PP/GLV 60/100 x 500mm	EKFGP4651
Extension PP/GLV 60/100 x 1000mm	EKFGP4652
Elbow PP/GLV 60/100 30°	EKFGP4664
Elbow PP/GLV 60/100 45°	EKFGP4661
Elbow PP/GLV 60/100 90°	EKFGP4660
Meas. Tee with Inspection Panel PP/GLV 60/100	EKFGP4667
Wall Bracket Dn.100	EKFGP4631
Wall Terminal Kit PP/GLV 60/100	EKFGP1292
Wall Terminal Kit low profile PP/GLV 60/100	EKFGP1293
Plume Management Kit 60 UK Only	EKFGP1294
Flue Deflector 60 UK Only	EKFGP1295
PMK Elbow 60 90 UK Only	EKFGP1284
PMK Elbow 60 45° (2 pcs) UK Only	EKFGP1285
PMK Extension 60 L=1000 incl. break UK Only	EKFGP1286
Roof Terminal PP/GLV 80/125 AR300 Ral-9011	EKFGP6864
Weather Slate Steep Pb/GLV 80/125 18°-22°	EKFGT6300
Weather Slate Steep Pb/GLV 80/125 23°-27°	EKFGT6301

Daikin Altherma ground source heat pump	
Ground source filling kit	KGSFILL
Remote user interface (DE, FR, NL, IT)	EKRUCBL1
Remote user interface (EN, SV, NO, FI)	EKRUCBL2
Remote user interface (EN, ES, EL, PT)	EKRUCBL3
Remote user interface (EN, TR, PL, RO)	EKRUCBL4
Remote user interface (DE, CS, SL, SK)	EKRUCBL5
Remote user interface (EN, HR, HU, BG)	EKRUCBL6
Remote user interface (EN, DE, RU, DA)	EKRUCBL7
Digital I/O PCB	EKRPIHBAA
Demand PCB	EKRPIAHTA
Remote indoor sensor	KRCS01-1
PC cable	EKPCCAB2
Wire harness	EKGSCONBP1
Room thermostat (wired)	EKRTWA
Room thermostat (wireless)	EKTRT1
External sensor	EKRTETS

Daikin Altherma low temperature split	4-8 kW	11-16 kW
Drain pan for outdoor (excl heater)	EKDP008CA	
Drain pan heater	EKDPH008CA	
U-beams for outdoor	EKFT008CA	
Remote sensor for outdoor	EKRSCA1	
Remote user interface (DE, FR, NL, IT)	EKRUCBL1	EKRUCBL1
Remote user interface (EN, SV, NO, FI)	EKRUCBL2	EKRUCBL2
Remote user interface (EN, ES, EL, PT)	EKRUCBL3	EKRUCBL3
Remote user interface (EN, TR, PL, RO)	EKRUCBL4	EKRUCBL4
Remote user interface (DE, CS, SL, SK)	EKRUCBL5	EKRUCBL5
Remote user interface (EN, HR, HU, BG)	EKRUCBL6	EKRUCBL6
Remote user interface (EN, DE, RU, DA)	EKRUCBL7	EKRUCBL7
Indoor drain pan for new wall mounted H/B	EKHBDPAC2	EKHBDPAC2
PC cable	EKPCCAB1	EKPCCAB1
Digital I/O PCB	-	EKRPIHBAA
Bottom plate heater	-	EKBPHTH16A
Drain kit	-	EKDK04
Snowcover	-	EK016SNCA
Demand PCB	-	EKRPIAHTA
Remote indoor sensor	-	KRCS01-1B
Drain pan for indoor wall munted	-	EKHBDPAC2
Booster heater for tank integrated design	-	EKBSHCA3V3

Daikin Altherma integrated solar unit	
Room thermostat	EHS157034
Mixer module	EHS157068
Gateway for apps	EHS157056
9kW backup heater	EKB09C

Daikin Altherma low temperature monobloc	6-8 kW	11-16 kW
Back up heater	EKMUBHA6V3	-
Cable	EKCOMCAB1	-
Digital I.O PCB	-	EKRPIHBAA
Bottom plate heater	-	EKBPHTH16A
Drain kit	-	EKDK04

Daikin Altherma hybrid heat pump	
Weather Slate Steep Pf 80/125 25°-45° Ral-9011	EKFGP7909
Weather Slate Steep Pb/GLV 80/125 43°-47°	EKFGT6305
Weather Slate Steep Pb/GLV 80/125 48°-52°	EKFGT6306
Weather Slate Steep Pb/GLV 80/125 53°-57°	EKFGT6307
Weather Slate Flat Alu 80/125 0°-15°	EKFGP1297
Weather Slate Flat Alu 80/125	EKFGW5333
Wall Terminal Kit PP/GLV 80/125	EKFGW6359
Extension PP/GLV 80/125 x 500mm	EKFGP4801
Extension PP/GLV 80/125 x 1000mm	EKFGP4802
Elbow PP/GLV 80/125 30°	EKFGP4814
Elbow PP/ALU 80/125 45°	EKFGP4811
Elbow PP/ALU 80/125 90°	EKFGP4810
Inspection Elbow Plus PP/ALU 80/125 90° EPDM	EKFGP4820
Wall Bracket Dn.100	EKFGP4481
Flex Kit PP Dn.60-80	EKFGP1856
Chimney Connection 60/100	EKFGP4678
Flex Kit PP Dn.80	EKFGP2520
Chimney Connection 80/125	EKFGP4828
Extension Flex PP 80 L=10 M	EKFGP6340
Extension Flex PP 80 L=15 M	EKFGP6344
Extension Flex PP 80 L=25 M	EKFGP6341
Extension Flex PP 80 L=50 M	EKFGP6342
Connector Flex-Flex PP 80	EKFGP6324
Spacer PP 80-100	EKFGP6333
Tee Flex 100 Boiler Connectionset 1	EKFGP6368
Flex 100-60 + Support Elbow	EKFGP6354
Tee Flex 130 Boiler Connectionset 1	EKFGP6215
Flex 130-60 + Support Elbow	EKFGS0257
Chimney Connection 60/100	EKFGP4678
Extension PP 60x500	EKFGP5461
Chimney Top PP 100 incl. Flue Pipe	EKFGP5497
Adapter Flex-Fixed PP 100	EKFGP6316
Support Breaket Top Inox Dn.100	EKFGP6337
Extension Flex PP 100 L=10 M	EKFGP6346
Extension Flex PP 100 L=15 M	EKFGP6349
Extension Flex PP 100 L=25 M	EKFGP6347
Connector Flex-Flex PP 100	EKFGP6325
Chimney Top PP 130 incl. Flue Pipe	EKFGP5197
Adapter Flex-Fixed PP 130	EKFGS0252
Support Breaket Top Inox Dn.130	EKFGP6353
Extension Flex PP 130 L=30 M	EKFGS0250
Connector Flex-Flex PP 130	EKFGP6366
Valve kit	EKVK1A
	EKVK2A
	EKVK3A
	EKHYPART

Daikin Altherma high temperature split	
Bottom plate heater	EKBPHTH16A
Digital I/O PCB	EKRPIHBAA
Demand PCB	EKRPIAHTA
Remote user interface	EKRUAHTB
Back up heater for HT	EKBHAA6V3
Back up heater for HT	EKBHAA6W1
Refrigerant stop valves	EKRSHVHTA
UK tank kit	EKUHWHTA
Compatibility kit 1	EKMKHT1A
Compatibility kit 2	EKMKHT2A

Daikin Altherma Flex Type		
options for outdoor unit	EKHVMRD	EKHVMYD
Refnet header	KHRQ(M)22M29H8	KHRQ(M)23M29H8
Refnet header	KHRQ(M)22M64H8	KHRQ(M)23M64H8
Refnet joint	KHRQ(M)22M20T8	KHRQ(M)23M20T8
Refnet joint	KHRQ(M)22M29T8	KHRQ(M)23M29T8
Refnet joint	KHRQ(M)22M64T8	KHRQ(M)23M64T8
central drain pan kit	KWC25C450	KWC25C450
options for indoor unit		
Stand alone kit	EKFMAHTB	
I/O PCB	EKRPIHBAA	
Demand PCB	EKRPIAHTA	
Remote user interface	EKRUAHTB	
Individual billing - connection kit	EKMBIL1	
Back up heater kit	EKBHAA6V3	
Back up heater kit	EKBHAA6W1	

Tanks	EKHWS	EKHWP	EKHTS
Wall bracket	EKWBSWW150	-	-
Connection kit EKHW300 for low temperature (heating only / heating and cooling)	-	EKDVCP3HX	-
Connection kit EKHW500 for low temperature (heating only)	-	EKDVCP3SH	-
Connection kit EKHW500 for low temperature (heating and cooling)	-	EKDVCP3SX	-
Connection kit for high temperature and VRV indoor HXHD125 (EKHW300/ EKHW500)	-	EKEPHT3H / EKEPHT5H	-
Connection kit for Daikin Altherma Flex Type (heating only)	-	EKEPHT3H	-
Connection kit for Daikin Altherma Flex Type (heating and cooling)	-	EKEPHT3H + 156034	-
Connection kit for Daikin Altherma hybrid heat pump	-	EKEPHT3H	EKEPHT3H
3 way valve	-	3-W-UV2	-
Booster heater with melting fuse (900mm)	-	EKBH3S	-
Option kit (EKHTS / EKHTSU)	-	-	EKFMALTA / EKUHWHTA

Heat pump connector	
Valve kit	EKVKHPC

Solar collectors	
Mounting kit on roof (antracite)	EKSRCAP
Mounting kit on roof (red)	EKSRCRP
Mounting kit on roof (excl. Roof tile)	EKSRCP
Gravity brake	16 50 70
Flow sensor	FLS12
Flow regulating valve with flow rate indicator	FLG
Connection set for additional heat source	EWS
Hot water recirculation kit	ZKL
Thermostatic antiscald mixing valve + 1" screw connection set	VTA32 + 156016
Solar Expansion vessel 12l	MAGS12
Solar Expansion vessel 25l	MAGS25
Solar Expansion vessel 35l	MAGS35
Pressureless Connection piping between solar panel & pump station: 15 meter	CON 15
Pressureless Connection piping between solar panel & pump station: 20 meter	CON 20
Unpressurised elongation pipe 2.5 m including couplings	CON X 25
Unpressurised elongation pipe 5 m including couplings	CON X 50
Unpressurised elongation pipe 10 m including couplings	CON X 100
Unpressurised elongation for inlet pipe 8 meter	CON XV 80
Pressure solar pipe DN16 - 15m	CON15P16
Connectors DN16	CONXP16
Pressure solar pipe DN20 - 15m	CON15P20
Connectors DN20	CONXP20
Connectors DN20	CON CP16
Connectors DN20	CON CP20
Mounting kit IN-ROOF	RCIP
Mounting kit FLAT ROOF	RCFP
Additional roof breakthrough for opposite side connection	CON FE
Connection kit between 2 solar panels	FIX VBP
Connection kit between 2 rows of Collectors	CON RVP
Connection kit between 2 rows of Collectors	CON LCP
Mounting support for V26P	FIX MP 130
Mounting support for H26P	FIX MP 200
Mounting support for V21P	FIX MP 100
Supporting shell for pressureless connection pipe	TS
Standard mounting set for on-roof mounting suitable for roof tiles	FIX AD
Variable height mounting set for on-roof mounting suitable for roof tiles	FIX ADP
Mounting set for on-roof mounting	FIX ADD
Mounting set for on-roof mounting suitable for flat tiles e.g. shingles	FIX ADS
Mounting set for on-roof mounting suitable for corrugated plates	FIX - WD
Mounting set for on-roof mounting suitable for metal roofs	FIX BD
Basic IN ROOF installation kit for 2 EKSV21P	IBV21P
Extension IN ROOF installation kit for 1 additional EKSV21P	IEV21P
Basic IN ROOF installation kit for 2 EKSV26P	IBV26P
Extension IN ROOF installation kit for 1 additional EKSV26P	IEV26P
IN ROOF covering slate complementing kit	FIX-IES
Basic FLAT ROOF support frame for 2 EKSV26P	FB V26P
Extension FLAT ROOF support frame for additional EKSV26P	FE V26P
Basic FLAT ROOF support frame for 1 EKSH26P	FB H26P
Extension FLAT ROOF support frame for additional EKSH26P	FE H26P
Release tool	FIX LP
Glycol fluid 20 l	GFL



Comfort all year round

The choice of the right system mostly depends on the specific project.

Every home is unique. Furthermore, it concerns the daily living environment.

Whether you are talking in terms of construction or renovation, small areas or large spaces, Daikin heat pumps adapt to each layout with efficiency.

Residential applications - split

Why choose a Daikin split system?	78		
Products overview	82		
Benefits overview	86		
R-32	89		
Wall mounted units	89		
Ururu Sarara	89		
FTXZ-N / RXZ-N	89		
Daikin Emura	91		
NEW FTXJ-MW/S / RXJ-M	91		
FTXM-K / RXM-L	92		
R-410A	94		
Wall mounted units	94		
Daikin Emura	94		
FTXG-LW/S / RXG-L	94		
C/FTXS-K/G / RXS-L(3)/F8	95		
NEW FTX-KV / RX-K	96		
FTX-J3/GV / RX-K/GV(B)	97		
FTXK-AW/S / RXK-A	98		
FTXB-C / RXB-C	99		
Floor standing units	100		
Nexura	100		
FVXG-K / RXG-L	100		
FVXS-F / RXS-L(3)	102		
Flexi type units	103		
FLXS-B(9) / RXS-L(3)	103		
Concealed ceiling unit	104		
FDXS-F(9) / RXS-L(3)	104		
FDBQ-B / (multi model applications only)	105		
		Multi outdoor units	107
		MXS-E/F/G/H/K	107
		NEW RXYSCQ-TV1	108
		NEW RXYSQ-TV1	109
		Siesta wall mounted units	110
		ATXS-K / ARXS-L(3)	111
		ATX-J3 / ARX-K	112
		NEW ATX-KV / ARX-K	113
		ATXN-NB9 / ARXN-NB9	114
		ATXB-C / ARXB-C	115
		Siesta multi outdoor unit	116
		AMX-E/G	116
		Optimised for heating	117
		Wall mounted units	118
		Daikin Emura	118
		FTXG-LW/S / RXLG-M	118
		NEW FTXLS-K3 / RXLS-M	119
		FTXL-JV / RXL-M3	120
		Floor standing units	121
		FVXG-K / RXLG-M	121
		FVXS-F / RXL-M3	122
		Siesta wall mounted unit	123
		ATXL-JV / ARXL-M	123
		Options & accessories	124
		Combination tables	126

Total comfort at home



Why choose a Daikin split system?

- The ideal solution for each application thanks to the **wide range of available products** both for cooling and heating
- **Low energy** bills thanks to high seasonal efficiencies up to A+++ and energy saving features such as intelligent eye and weekly timer
- Control via a **smartphone app** or a user friendly remote controller
- Perfect indoor climate: **whisper quiet sound** level & **perfect airflow** pattern

Any kind of indoor unit

- 1. Wall mounted unit:**
a wide range from top efficiency and design units to units offering good value for money
- 2. Floor standing unit:**
ideal for heating comfort, offering features like a radiant heat panel.
- 3. Concealed ceiling unit:**
as it can be mounted in a ceiling void, it blends unobtrusively with any décor as only the grilles are visible.
- 4. Flexi type unit:**
can fit on either ceiling or lower wall.



1. Daikin Emura
Wall mounted unit



2. Nexura
Floor standing unit

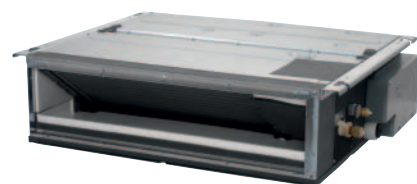

3. FDXS-F(9)
Concealed ceiling unit

One or multiple rooms? The choice is yours.

With **1** multi **outdoor unit**, up to **5 or 9*** **indoor units** can be connected. All indoor units can be **individually controlled** and do not need to be installed in the same room or even at the same time.

* with RXYS(C)Q-TV1



R-32 - the refrigerant of the future

R-32

Daikin is leading the way to the most energy efficient product range with the lowest environmental impact

- > **68% Reduction in environmental impact** compared to R-410A
- > **High energy efficiency** leading directly to lower energy consumption
- > Already a wide range of wall mounted units available in R-32 (FTXZ-N, FTXJ-MW/S, FTXM-K)

Optimised for heating



Our special split range optimised for heating is suitable for colder climates, even withstanding severe winter conditions

- > Guaranteed capacity down to -25°C
- > High heating energy efficiency with SCOP up to A++
- > Improved defrost thanks to unique **free hanging coil** technology

Online controller

Always in control, no matter where you are



Control your indoor from any location with an app (available for iOS & Android), via your local network or internet. It is now connectable to most of the split indoors.





FVXS-F

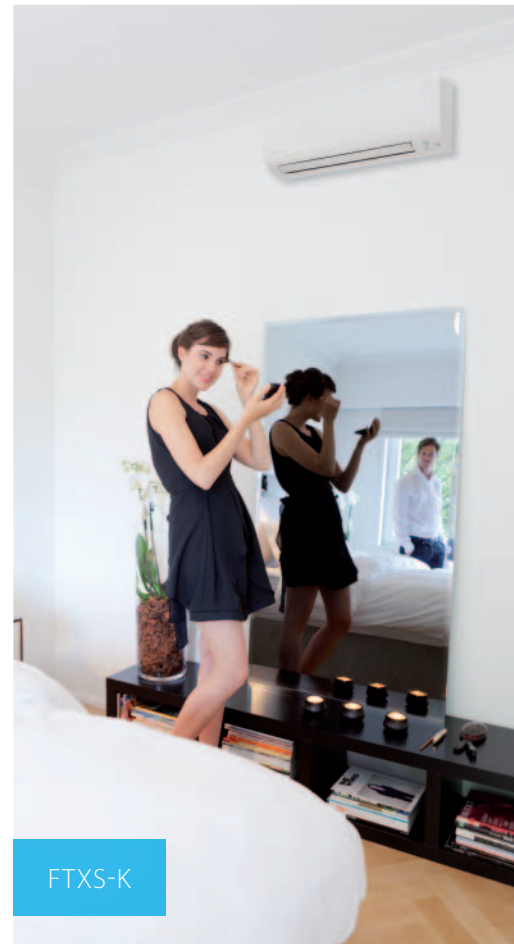

FTXS-K



NEXURA FVXG-K



















URURU SARARA FTXZ-N













DAIKIN EMURA FTXG-LS

Products overview















Indoor units

Refrigerant	Type	Model	Product name	15	20	25	35	42	50	60	71		
R-32	Wall mounted	Ururu Sarara Complete climate control with (de) humidification, air purification & ventilation with top efficiencies in heating & cooling	FTXZ-N 			● (pair only)	● (pair only)		● (pair only)				
		Daikin Emura Design at its best, delivering superior efficiency and comfort	FTXJ-MW/S 		● (pair only)	● (pair only)	● (pair only)		● (pair only)				
		Wall mounted unit Discreet, modern design for optimal efficiency and comfort thanks to 2 area intelligent eye	FTXM-K 		● (pair only)	● (pair only)	● (pair only)	● (pair only)	● (pair only)				
R-410A	Wall mounted	Daikin Emura Design at its best, delivering superior efficiency and comfort	FTXG-LW/S 		●	●	●		●				
		Wall mounted unit Discreet, modern design for optimal efficiency and comfort thanks to 2 area intelligent eye	CTXS-K 	● (multi only)			● (multi only)						
		Wall mounted unit For optimal efficiency and comfort, ideal for large rooms	FTXS-G 								●	●	
		Wall mounted unit Providing high efficiency and comfort	FTX-KV 		●	●	●			● (pair only)	● (pair only)	● (pair only)	
		Wall mounted unit Providing high efficiency and comfort	FTX-J3 		●	●	●						
		Wall mounted unit For low energy consumption and pleasant comfort	FTX-GV 							● (pair only)	● (pair only)	● (pair only)	
		Wall mounted unit For low energy consumption and pleasant comfort	FTXK-AW/S 			● (pair only)	● (pair only)			● (pair only)	● (pair only)		
		Wall mounted unit For low energy consumption and pleasant comfort	FTXB-C 		● (pair only)	● (pair only)	● (pair only)			● (pair only)	● (pair only)		
		Floor standing	Nexura - floor standing unit with radiant heat panel Stylish floor standing unit with radiant heat panel for comfortable heat and very low noise	FVXG-K 			●	●			●		
			Floor standing unit Floor standing unit for optimal heating comfort thanks to dual airflow	FVXS-F 			●	●			●		
Flexi type	Flexi type unit Flexible unit, ideal for rooms without false ceiling, can fit on either ceiling or wall	FLXS-B(9) 			●	●			●	● (multi only)			
Concealed ceiling	Slim concealed ceiling unit Compact concealed ceiling unit, with a height of only 200mm	FDXS-F(9) 			●	●			●	●			
	Small concealed ceiling unit - Multi model applications Designed for hotel applications	FDBQ-B 			● (multi only)								

Refrigerant	Type	Model	Product name	15	20	25	35	42	50	60	71	
R-410A	Wall mounted	<i>Siesta</i> Wall mounted unit Siesta, discreet, modern unit for optimal efficiency and comfort thanks to 2 area intelligent eye	ATXS-K			● (multi only)	●	●		●		
		Wall mounted unit Siesta, providing high efficiency and comfort	ATX-J3			●	●	●				
		Wall mounted unit Siesta, offering good value for money and ensuring a steady supply of clean air	ATX-KV			●	●	●				
		Wall mounted unit Siesta, for low energy consumption and pleasant comfort	ATXN-NB9				● (pair only)	● (pair only)		● (pair only)	● (pair only)	
		Wall mounted unit Siesta, for low energy consumption and pleasant comfort	ATXB-C				● (pair only)	● (pair only)		● (pair only)	● (pair only)	
R-410A Designed for colder climates	Wall mounted	Daikin Emura Design at its best, delivering superior efficiency and comfort	FTXG-LW/S			● (pair only)	● (pair only)					
		Wall mounted unit Discreet, modern design for optimal efficiency and comfort thanks to 2 area intelligent eye	FTXLS-K3				● (pair only)	● (pair only)				
		Wall mounted unit Providing high efficiency and comfort	FTXL-JV				● (pair only)	● (pair only)				
	Floor standing	Nexura - floor standing unit with radiant heat panel Stylish floor standing unit with radiant heat panel for comfortable heat and very low noise	FVXG-K				● (pair only)	● (pair only)				
		Floor standing unit Floor standing unit for optimal heating comfort thanks to dual airflow	FVXS-F				● (pair only)	● (pair only)				
	Wall mounted	<i>Siesta</i> Wall mounted unit Siesta, providing high efficiency and comfort even at low ambient temperatures	ATXL-JV				● (pair only)	● (pair only)				

Products overview

Outdoor units

Refrigerant	Type	Model	Product name	20	25	35	40	42	50	52	60	68	71	80	90	4HP	5HP	6HP		
R-32	Air cooled	Pair heat pump	RXZ-N			•	•			•										
			RXJ-M		•	•	•			•										
			RXM-L		•	•	•		•	•										
			RXG-L		•	•	•			•										
			RXS-L(3)		•	•	•		•	•			•							
	Air cooled	Pair heat pump	RXS-F8											•						
			RX-K		•	•	•			•		•								
			RX-GV (B)							•		•		•						
			RXK-A			•	•			•		•								
			RXB-C		•	•	•			•		•								
R-410A	Air cooled	Multi heat pump	2-port MXS-H					•	•											
			3-port MXS-K				•													
			3-port MXS-E								•									
			3-port MXS-G											•						
			4-port MXS-F											•						
			4-port MXS-E													•				
			5-port MXS-E														•			
			RXYSQ-TV1															•	•	
			RXYSQ-TV1															•	•	•

Refrigerant	Type	Model	Product name	20	25	35	40	42	50	52	60	68	71	80	90	4HP	5HP	6HP	
R-410A	Air cooled <i>Siesta</i>	Pair heat pump	ARXS-L(3)			•	•		•										
			ARX-K		•	•	•												
			ARXN-NB9			•	•			•		•							
		Multi heat pump	ARXB-C			•	•			•		•							
			2-port AMX-G					•		•									
			3-port AMX-E									•							
R-410A	Air cooled Designed for colder climates	Pair heat pump down to -25°C	RXLG-M			•	•												
			RXLS-M			•	•												
			RXL-M3			•	•												
	Air cooled <i>Siesta</i>	Pair heat pump down to -25°C	ARXL-M			•	•												

Benefits overview

Split

		R-32											
		Wall mounted						Wall mounted					
		FTXZ-N	FTXJ-MW/S	FTXM-K	FTXG-LW/S	CTXS-K	FTXS-K	FTXS-G	FTX-KV	FTX-J3	FTX-GV	FTXK-AW/S	FTXB-C
We care	Econo mode	•	•	•	•	•	•	•	•	•			•
	2-area intelligent eye		•	•	•		• 35,42,50 class						
	3-area intelligent eye	•											
	Movement sensor			•		•	• 20,25 class	•			•		
	Energy saving during operation standby	•	•	•	•	•	•		•	•			•
	Home leave operation										•		
	Night set mode		•	•	•	•	•	•	•	•	•	•	•
	Fan only	•	•	•	•	•	•	•	•	•	•	•	•
	Auto cleaning filter	•											
	Comfort	Comfort mode	•	•	•	•	•	•	•	•	•		
Powerful mode		•	•	•	•	•	•	•	•	•	•	•	•
Auto cooling-heating changeover		•	•	•	•	•	•	•	•	•	•	•	•
Whisper quiet (down to 19dBA)		•	•	•	•	•	•						•
Radiant heat													
Indoor unit silent operation		•	•	•	•	•	•	•	•	•	•	•	•
Comfortable sleeping mode		•											•
Outdoor unit silent operation		•	•	•	•	•	•	•		•	•		
3-D Air flow		•	•	•	•		• 35,42,50 class	•			•		
Air flow		Vertical auto swing	•	•	•	•	•	•	•	•	•	•	•
	Horizontal auto swing	•	•	•	•		• 35,42,50 class	•			•		
	Auto fan speed	•	•	•	•	•	•	•	•	•	•	•	•
	Fan speed steps	5	5	5	5	5	5	5	5	5	5	3	3
	Ururu - humidification	•											
Humidity control	Sarara - dehumidification	•											
	Dry programme		•	•	•	•	•	•	•	•	•	•	•
	Flash streamer	•											
Air treatment	Titanium photocatalytic air purification filter	•	•	•	•	•	•	•	•	•	•		
	Photocatalytic deodorising filter												
	Air filter											•	•
	Online controller	•	•	•	•	•	•	•	•	•	•		
Remote control & timer	Weekly timer		•	•	•	•	•	•					
	24 Hour timer	•	•	•	•	•	•	•		•	•	•	•
	Infrared remote control	•	•	•	•	•	•	•	•	•	•	•	•
	Wired remote control		•	•	•	•	•	•	•	•	•	•	
	Centralised remote control	•	•	•	•	•	•	•			•		
Other functions	Auto-restart	•	•	•	•	•	•	•	•	•	•		•
	Self-diagnosis	•	•	•	•	•	•	•	•	•	•		•
	Multi model application			•	•	•	•	•	•	•			
	VRV for residential application				•	•	•	•					
	Guaranteed operation down to -25°C												

For explanation on the benefits, see the end of this catalogue.

The best of the best



reddot design award winner 2013

Why choose Ururu Sarara?

- First R-32 air to air heat pump in the European market at lowest environmental impact thanks to high energy efficiency and use of low GWP refrigerant.
- **Market leader in terms of seasonal efficiency.**
- Advanced technologies have been integrated to create the perfect indoor climate by controlling not only the room temperature but **also air quality and humidity.**

Benefits

- › Low energy bill thanks to very high seasonal energy efficiency (A+++ in heating and cooling)
- › Perfect indoor comfort thanks to 5 air treatment technologies and 3 area intelligent eye
- › Optimal airflow distribution: cools down spaces in a fast, efficient and controllable way!
- › Award winning design!
- › No need to clean filters thanks to self cleaning filter
- › New remote control: user friendly with backlight and information on actual energy consumption
- › As easy to install as any R-410A unit
- › Wide operation range, from -20°C to +43°C
- › Online controller: always in control, no matter where you are



Supporting tools

NEW Business portal

- › Experience our new extranet that thinks with you at my.daikin.eu
- › Find information in seconds via a powerful search
- › Customise the options so you see only info relevant for you
- › Access via mobile device or desktop

Internet

- › Visit the website: www.daikineurope.com/for-your-home/needs/air-conditioning/ururu-sarara/index.jsp

Literature

- › See all literature available on www.daikineurope.com/support-and-manuals/catalogues

5 air treatment techniques

Perfect indoor climate

- › Cooling & heating
- › Fresh air (ventilation)
- › Ururu Humidification
- › Sarara Dehumidification
- › Air purification

Lowest environmental impact

- › SEER and SCOP A+++
- › Low GWP refrigerant R-32

R-32

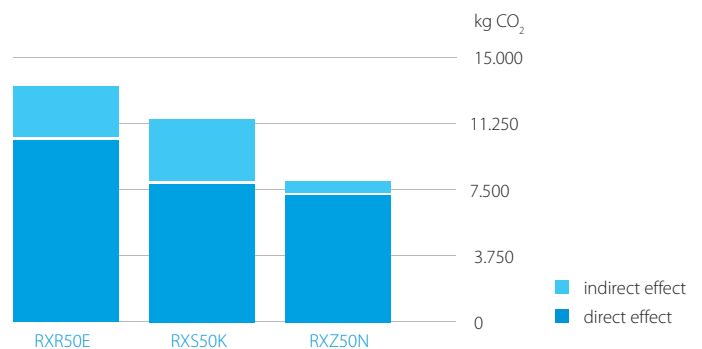

Perfect comfort thanks to 3 area intelligent eye:

- › Air flow is sent to a zone other than where the person is located at that moment. Detection is done in 3 directions: left, front & right.
- › If no people are detected, the unit automatically switches over to energy-efficient setting and eventually switches off.



Wall mounted unit

Complete climate control with (de)humidification, air purification & ventilation with top efficiencies in heating & cooling

- › SEER + SCOP = A+++ on the entire range
- › No need to clean filters, thanks to the self cleaning filter
- › Unique combination of humidification, dehumidification, ventilation, air purification and heating & cooling in 1 system
- › 3 area intelligent eye: air flow is sent to a zone other than where the person is located at that moment. Detection is done in 3 directions: left, front and right. If no people are detected, the unit will automatically switch over to the energy-efficient setting
- › Reddot design award winner 2013
- › Online controller (optional): control your indoor from any location with an app, via your local network or internet
- › First R-32 air-to-air heat pump in the European market



Efficiency data		FTXZ + RXZ		25N + 25N	35N + 35N	50N + 50N
Cooling capacity	Min./Nom./Max.	kW		0.6/2.5/3.9	0.6/3.5/5.3	0.6/5.0/5.8
Heating capacity	Min./Nom./Max.	kW		0.6/3.6/7.5	0.6/5.0/9.0	0.6/6.3/9.4
Power input	Cooling	Min./Nom./Max.	kW	0.11/0.41/0.88	0.11/0.66/1.33	0.11/1.10/1.60
	Heating	Min./Nom./Max.	kW	0.10/0.62/2.01	0.10/1.00/2.53	0.10/1.41/2.64
Seasonal efficiency (according to EN14825)	Cooling	Energy label		A+++		
		Pdesign	kW	2.50	3.50	5.00
		SEER		9.54	9.00	8.60
	Heating (Average climate)	Energy label		A+++		
		Pdesign	kW	3.50	4.50	5.60
		SCOP		5.90	5.73	5.50
	Annual energy consumption	kWh	831	1,100	1,427	
Nominal efficiency	EER		6.10	5.30	4.55	
	COP		5.80	5.00	4.47	
	Annual energy consumption	kWh	205	330	550	
	Energy label	Cooling/Heating		A/A		

Indoor unit		FTXZ		25N	35N	50N
Dimensions	Unit	HeightxWidthxDepth	mm	295x798x372		
Weight	Unit		kg	15		
Air filter	Type			Auto cleaning filter		
Fan - Air flow rate	Cooling	High/Nom./Low/Silent operation	m ³ /min	10.7/7.5/5.3/4.0	12.1/8.4/5.6/4.0	15.0/9.2/6.6/4.6
	Heating	High/Nom./Low/Silent operation	m ³ /min	11.7/8.6/6.7/4.8	13.3/9.2/6.9/4.8	14.4/10.7/7.7/5.9
Sound power level	Cooling		dB(A)	54	57	60
	Heating		dB(A)	56	57	59
Sound pressure level	Cooling	High/Nom./Low/Silent operation	dB(A)	38/33/26/19	42/35/27/19	47/38/30/23
	Heating	High/Nom./Low/Silent operation	dB(A)	39/35/28/19	42/36/29/19	44/38/31/24
Control systems	Infrared remote control			ARC477A1		
Power supply	Phase / Frequency / Voltage		Hz / V	1~ / 50 / 220-240		

Outdoor unit		RXZ		25N	35N	50N
Dimensions	Unit	HeightxWidthxDepth	mm	693x795x300		
Weight	Unit		kg	50		
Sound power level	Cooling		dB(A)	59	61	63
	Heating		dB(A)	59	61	64
Sound pressure level	Cooling	High	dB(A)	46	48	49
	Heating	High	dB(A)	46	48	50
Operation range	Cooling	Ambient	Min.-Max. °CDB	-10~43		
	Heating	Ambient	Min.-Max. °CWB	-20~18		
Refrigerant	Type/Charge/GWP		kg/TCO ₂ eq	R-32/1.34/0.9/675		
Piping connections	Liquid	OD	mm	6.35		
	Gas	OD	mm	9.5		
	Piping length	OU - IU	Max. m	10		
	Level difference	IU - OU	Max. m	8		
Power supply	Phase / Frequency / Voltage		Hz / V	1~ / 50 / 220-240		
Current - 50Hz	Maximum fuse amps (MFA)		A	16		

(1) EER/COP according to Eurovent 2012, for use outside EU only (2) MFA is used to select the circuit breaker and the ground fault circuit interrupter (earth leakage circuit breaker). For more detailed information on each combination, please refer to the electrical data drawing.

Daikin Emura Form. Function. Redesigned

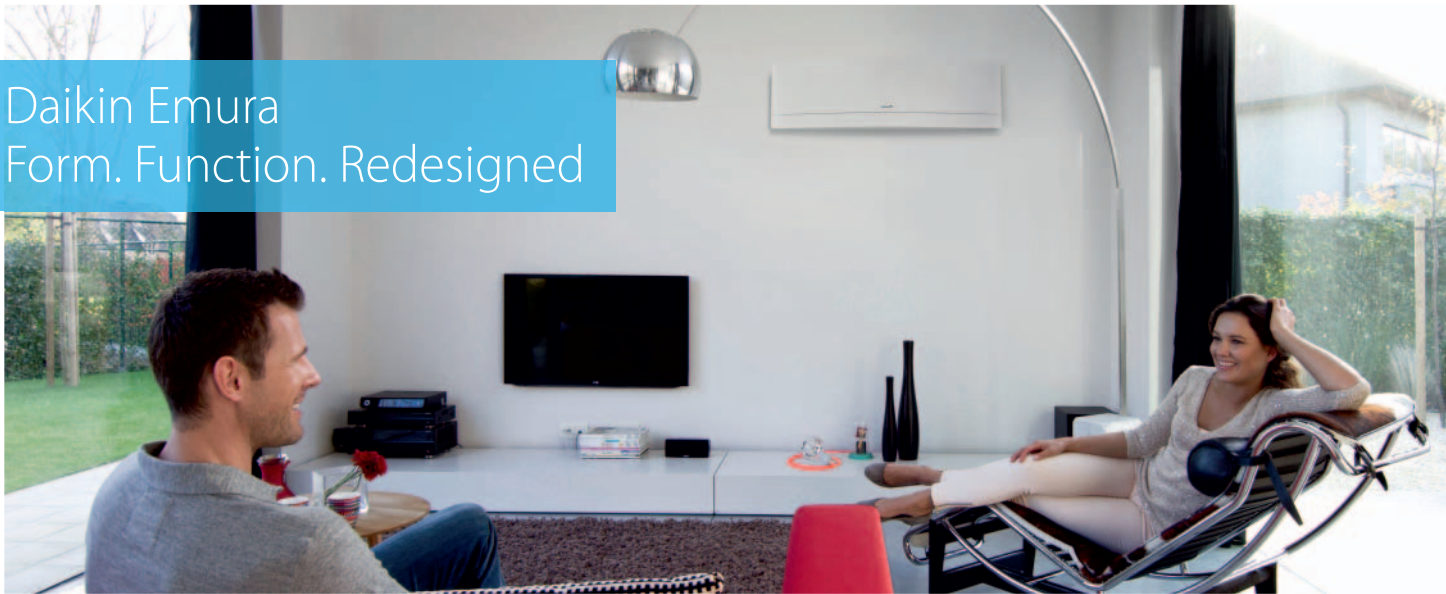

Why choose Daikin Emura?

- Unique **design**.
Designed in Europe for Europe.
- High seasonal **efficiency**, further improved by energy saving techniques like weekly timer and intelligent eye.
- Optimal **comfort** thanks to advanced technologies e.g. 2-area intelligent eye, whisper quiet operation and online controller.

Supporting tools

NEW Business portal

- › Experience our new extranet that thinks with you at my.daikin.eu
- › Find information in seconds via a powerful search
- › Customise the options so you see only info relevant for you
- › Access via mobile device or desktop

Internet

- › Visit the website: www.daikinemura.eu

Literature

- › See all literature available on www.daikineurope.com/support-and-manuals/catalogues

Benefits

- › A remarkable blend between iconic design and engineering excellence
- › Stylish design in matt crystal white and silver
- › The choice between R-32 and R-410A model
- › Whisper quiet with sound levels down to 19 dBA
- › Horizontal and vertical autoswing
- › 2-area intelligent eye saves energy by reducing the set point if nobody is present and directs airflow away from people, thus avoiding cold draught
- › Weekly timer
- › Guaranteed operation down to -25°C (with RXLG-M)
- › Connectable to pair, multi and (mini) VRV
- › Online controller: Always in control no matter where you are



Unique design

Daikin is the only manufacturer offering a design model designed in Europe for the European market, using European technical and design standards to meet exactly with the customer's needs. Daikin Europe N.V. is also proud to announce that Daikin Emura has been awarded with several design awards.

Improved energy efficiency

Seasonal efficiency gives a more realistic indication on how efficient air conditioners operate over an entire heating or cooling season. The label includes multiple classifications from A+++ to G. Daikin Emura achieves high energy efficiencies:

- › SEER up to **A+++**
- › SCOP up to **A++**

Lowest environmental impact

- › Possible to choose between an R-32 and R-410A model

R-32 **R-410A**

Comfort

- › 2-Area intelligent eye: Air flow is sent to a zone other than where the person is located at that moment. If no people are detected, the unit will automatically switch over to the energy efficient setting.
- › Whisper quiet: Daikin Emura is whisper quiet with sound levels down to 19dBA.



Wall mounted unit

Design at its best, delivering superior efficiency and comfort

- › Seasonal efficiency values up to A+++
- › Choosing for an R-32 product, reduces the environmental impact with 68% compared to R-410A and leads directly to lower energy consumption thanks to its high energy efficiency
- › Remarkable blend of iconic design and engineering excellence with an elegant finish in silver and anthracite or in matt crystal white
- › Daikin Emura has been awarded with Reddot design award 2014 by an international jury, thanks to its excellent design
- › Designed to perfectly balance technological leadership and the beauty of aerodynamics
- › Online controller (optional): control your indoor from any location with an app, via your local network or internet
- › Whisper quiet in operation: the operating of the unit can hardly be heard. The sound pressure level goes down to 19dBA!



Efficiency data			FTXJ + RXJ	20MW + 20L	20MS + 20L	25MW + 25L	25MS + 25L	35MW + 35L	35MS + 35L	50MW + 50L	50MS + 50L
Cooling capacity	Min./Nom./Max.	kW		1.30/2.30/2.80		0.90/2.40/3.30		0.90/3.50/4.10		1.40/4.80/5.50	
	Min./Nom./Max.	kW		1.30/2.50/4.30		0.90/3.20/4.70		0.90/4.00/5.10		1.10/5.80/7.00	
Power input	Cooling	Min./Nom./Max. kW		0.320/0.495/0.760		0.230/0.507/0.820		0.230/0.855/1.360		0.270/1.432/1.950	
	Heating	Min./Nom./Max. kW		0.310/0.500/1.120		0.180/0.700/1.340		0.180/0.990/1.480		0.240/1.590/2.120	
Seasonal efficiency (according to EN14825)	Cooling	Energy label		A+++			A++				
		Pdesign	kW	2.30		2.40		3.50		4.80	
		SEER		8.73		8.64		7.19		7.02	
	Heating (Average climate)	Annual energy consumption	kWh	92		97		170		239	
		Energy label		A++			A+				
		Pdesign	kW	2.10		2.70		3.00		4.60	
Nominal efficiency	EER	SCOP		4.60			4.28				
		Annual energy consumption	kWh	638		822		913		1,505	
	COP	EER		4.64		4.73		4.09		3.35	
		Annual energy consumption	kWh	5.00		4.57		4.04		3.65	
Energy label	Cooling/Heating		A/A								

Indoor unit			FTXJ	20LW	20LS	25LW	25LS	35LW	35LS	50LW	50LS
Dimensions	Unit	HeightxWidthxDepth	mm	303x998x212							
Weight	Unit		kg	12							
Air filter	Type			Removable / washable / mildew proof							
Fan - Air flow rate	Cooling	High/Nom./Low/Silent operation	m ³ /min	8.9/6.6/4.4/2.6				10.9/7.8/4.8/2.9		10.9/8.9/6.8/3.6	
	Heating	High/Nom./Low/Silent operation	m ³ /min	10.2/8.4/6.3/3.8		11.0/8.6/6.3/3.8		12.4/9.6/6.9/4.1		12.6/10.5/8.1/5.0	
Sound power level	Cooling		dBA	54				59		60	
	Heating		dBA	56				59		60	
Sound pressure level	Cooling	High/Nom./Low/Silent operation	dBA	38/32/25/19				45/34/26/20		46/40/35/32	
	Heating	High/Nom./Low/Silent operation	dBA	40/34/28/19		41/34/28/19		45/37/29/20		47/41/35/32	
Control systems	Infrared remote control			ARC466A9							
Power supply	Phase / Frequency / Voltage	Hz / V		1~ / 50 / 220-240							

Outdoor unit			RXJ	20L	25L	35L	50L
Dimensions	Unit	HeightxWidthxDepth	mm	550x765x285			735x825x300
Weight	Unit		kg	34			44
Sound power level	Cooling		dBA	61			63
	Heating		dBA	62			63
Sound pressure level	Cooling	High/Silent operation	dBA	46/43			48/45
	Heating	High/Silent operation	dBA	47/44			48/45
Operation range	Cooling	Ambient Min.-Max.	°CDB	-10~46			
	Heating	Ambient Min.-Max.	°CWB	-15~18			
Refrigerant	Type/Charge/GWP	kg/TCO ₂ eq		R-32/0.72/0.5/675			R-32/1.30/0.9/675
Piping connections	Liquid	OD	mm	6.35			
	Gas	OD	mm	9.5			12.7
Piping length	OU - IU	Max.	m	20			30
	System	Chargeless	m	10			
Additional refrigerant charge	Level difference	IU - OU	Max.	0.02 (for piping length exceeding 10m)			20
	Level difference	IU - OU	Max.	15			20
Power supply	Phase / Frequency / Voltage	Hz / V		1~ / 50 / 220-240			
Current - 50Hz	Maximum fuse amps (MFA)	A		10			15

*Note: blue cells contain preliminary data

(1) EER/COP according to Eurovent 2012, for use outside EU only (2) MFA is used to select the circuit breaker and the ground fault circuit interrupter (earth leakage circuit breaker). For more detailed information on each combination, please refer to the electrical data drawing.

Wall mounted unit

Discreet, modern design for optimal efficiency and comfort thanks to 2 area intelligent eye

- › Choosing for an R-32 product, reduces the environmental impact with 68% compared to R-410A and leads directly to lower energy consumption thanks to its high energy efficiency
- › Discreet, modern design. Its smooth curve blends beautifully with the wall resulting in an unobtrusive presence that matches all interior décors.
- › High quality matt crystal white finish
- › Whisper quiet in operation: the operating of the unit can hardly be heard. The sound pressure level goes down to 19dB(A)
- › Ideal for installation in bedrooms (20,25 class) and larger or irregular shaped living areas (35,42,50 class)
- › 2-area intelligent eye: air flow is sent to a zone other than where the person is located at that moment; if no people are detected, the unit will automatically switch over to the energy-efficient setting. (35,42,50 class)
- › Online controller (optional): control your indoor from any location with an app, via your local network or internet



Efficiency data		FTXM + RXM		20K + 20L	25K + 25L	35K + 35L	42K + 42L	50K + 50L
Cooling capacity	Min./Nom./Max.	kW		1.30/2.00/2.80	1.30/2.50/3.20	1.40/3.50/4.00	1.70/4.20/5.00	1.70/5.02/5.30
Heating capacity	Min./Nom./Max.	kW		1.30/2.50/4.30	1.30/2.80/4.70	1.40/4.00/5.20	1.70/5.40/6.00	1.70/5.80/6.50
Power input	Cooling	Min./Nom./Max.	kW	0.320/0.441/0.760	0.320/0.576/1.000	0.350/0.855/1.190	0.320/1.213/2.330	0.350/1.476/1.810
	Heating	Min./Nom./Max.	kW	0.310/0.550/1.120	0.310/0.620/1.410	0.340/0.840/1.460	0.400/1.310/1.980	0.300/1.450/2.000
Seasonal efficiency (according to EN14825)	Cooling	Energy label		A++				
		Pdesign	kW	2.00	2.50	3.50	4.20	5.00
		SEER		7.79	8.30	7.81	7.14	7.22
	Heating (Average climate)	Annual energy consumption	kWh	90	105	157	206	242
		Energy label		A++			A+	
		Pdesign	kW	2.30	2.50	3.60	4.00	4.60
Nominal efficiency	EER	SCOP		4.77	4.78	4.85	4.38	4.55
		Annual energy consumption	kWh	675	733	1,039	1,278	1,416
	COP	EER		4.53	4.34	4.09	3.46	3.40
		Annual energy consumption	kWh	4.55	4.52	4.76	4.12	4.00
Energy label	Cooling/Heating		A/A					

Indoor unit		FTXM		20K	25K	35K	42K	50K
Dimensions	Unit	HeightxWidthxDepth	mm	289x780x215			298x900x215	
Weight	Unit		kg	8			11	
Air filter	Type			Removable / washable / mildew proof				
Fan - Air flow rate	Cooling	High/Nom./Low/Silent operation	m ³ /min	8.8/6.7/4.7/3.9	9.1/7.0/5.0/3.9	11.2/8.5/5.8/4.1	11.2/9.1/7.0/4.1	11.9/9.6/7.4/4.5
	Heating	High/Nom./Low/Silent operation	m ³ /min	9.5/7.8/6.0/4.3	10.0/8.0/6.0/4.3	12.1/9.3/6.5/4.2	12.4/10.0/7.8/5.2	13.3/10.8/8.4/5.5
Sound power level	Cooling		dBA	56	57	59		60
	Heating		dBA	56	57	59		60
Sound pressure level	Cooling	High/Nom./Low/Silent operation	dBA	40/32/24/19	41/33/25/19	45/37/29/19	45/39/33/21	46/40/34/23
	Heating	High/Nom./Low/Silent operation	dBA	40/34/27/19	41/34/27/19	45/39/29/19	45/39/33/22	47/40/34/24
Control systems	Infrared remote control			ARC466A6			ARC466A9	
Power supply	Phase / Frequency / Voltage		Hz / V	1~ / 50 / 220-240				

Outdoor unit		RXM		20L	25L	35L	42L	50L	
Dimensions	Unit	HeightxWidthxDepth	mm	550x765x285			735x825x300		
Weight	Unit		kg	34			44		
Sound power level	Cooling		dBA	59		61	59		
	Heating		dBA	60		61	60		
Sound pressure level	Cooling	High/Silent operation	dBA	47/43		49/44	47/44		
	Heating	High/Silent operation	dBA	48/44		49/45	48/45		
Operation range	Cooling	Ambient	Min.-Max. °CDB	-10~-46					
	Heating	Ambient	Min.-Max. °CWB	-15~-18					
Refrigerant	Type/Charge/GWP		kg/TCO ₂ eq	R-32/0.72/0.5/675		R-32/0.8/0.5/675		R-32/1.50/1.0/675	
Piping connections	Liquid	OD	mm	6.35					
	Gas	OD	mm	9.5			12.7		
	Piping length	OU - IU	Max.	m	20			30	
		System	Chargeless	m	10				
Additional refrigerant charge	Level difference	IU - OU	Max.	15			20		
	Phase / Frequency / Voltage		Hz / V	1~ / 50 / 220-240					
Current - 50Hz	Maximum fuse amps (MFA)		A	10			15		

(1) EER/COP according to Eurovent 2012, for use outside EU only (2) MFA is used to select the circuit breaker and the ground fault circuit interrupter (earth leakage circuit breaker). For more detailed information on each combination, please refer to the electrical data drawing.



Wall mounted unit

Design at its best, delivering superior efficiency and comfort

- › Seasonal efficiency values up to A+++
- › Remarkable blend of iconic design and engineering excellence with an elegant finish in silver and anthracite or in matt crystal white
- › Daikin Emura has been awarded with Reddot design award 2014 by an international jury, thanks to its excellent design
- › Designed to perfectly balance technological leadership and the beauty of aerodynamics
- › Online controller (optional): control your indoor from any location with an app, via your local network or internet
- › Whisper quiet in operation: the operating of the unit can hardly be heard. The sound pressure level goes down to 19dB(A)



Efficiency data			FTXG + RXG	20LW + 20L	20LS + 20L	25LW + 25L	25LS + 25L	35LW + 35L	35LS + 35L	50LW + 50L	50LS + 50L
Cooling capacity	Min./Max.		kW	1.3/2.8		1.3/3.0		1.4/3.8		1.7/5.3	
Heating capacity	Min./Max.		kW	1.3/4.3		1.3/4.5		1.4/5.0		1.7/6.5	
Power input	Cooling	Min./Nom./Max.	kW	0.320/0.501/0.760		0.320/0.523/0.820		0.350/0.882/1.190		0.370/1.360/1.880	
	Heating	Min./Nom./Max.	kW	0.310/0.500/1.120		0.310/0.769/1.320		0.320/0.985/1.490		0.310/1.589/2.490	
Seasonal efficiency (according to EN14825)	Cooling	Energy label		A+++				A++			
		Pdesign	kW	2.30		2.40		3.50		4.80	
		SEER		8.52		8.50		7.00		6.70	
	Heating (Average climate)	Energy label		A++				A+			
		Pdesign	kW	2.10		2.70		3.00		4.60	
		Annual energy consumption	kWh	639		821		913		1,519	
Nominal efficiency	EER		4.59				3.97				
	COP		5.00		4.42		4.06		3.65		
	Annual energy consumption	kWh	250.5		261.5		441		680		
	Energy label	Cooling/Heating	A/A								

Indoor unit			FTXG	20LW	20LS	25LW	25LS	35LW	35LS	50LW	50LS	
Dimensions	Unit	HeightxWidthxDepth	mm	303x998x212								
Weight	Unit		kg	12								
Air filter	Type			Removable / washable / mildew proof								
Fan - Air flow rate	Cooling	High/Nom./Low/Silent operation	m ³ /min	8.9/6.6/4.4/2.6				10.9/7.8/4.8/2.9		10.9/8.9/6.8/3.6		
	Heating	High/Nom./Low/Silent operation	m ³ /min	10.2/8.4/6.3/3.8		11.0/8.6/6.3/3.8		12.4/9.6/6.9/4.1		12.6/10.5/8.1/5.0		
Sound power level	Cooling		dB(A)	54				59		60		
	Heating		dB(A)	56				59		60		
Sound pressure level	Cooling	High/Nom./Low/Silent operation	dB(A)	38/32/25/19				45/34/26/20		46/40/35/25		
	Heating	High/Nom./Low/Silent operation	dB(A)	40/34/28/19		41/34/28/19		45/37/29/20		47/41/35/25		
Control systems	Infrared remote control			ARC466A1								
Power supply	Phase / Frequency / Voltage		Hz / V	1~ / 50 / 220-240								
Outdoor unit			RXG	20L	25L	35L	50L					
Dimensions	Unit	HeightxWidthxDepth	mm	550x765x285				735x825x300				
Weight	Unit		kg	35				48				
Sound power level	Cooling		dB(A)	61				63				
	Heating		dB(A)	62				63				
Sound pressure level	Cooling	High/Silent operation	dB(A)	46/43				48/45		48/44		
	Heating	High/Silent operation	dB(A)	47/44				48/45		48/44		
Operation range	Cooling	Ambient Min.-Max.	°CDB	-10~46								
	Heating	Ambient Min.-Max.	°CWB	-15~18								
Refrigerant	Type/Charge/GWP		kg/TCO ₂ eq	R-410A/1.05/2.2/2,087.5				R-410A/1.6/3.3/2,087.5				
Piping connections	Liquid	OD	mm					6.35				
	Gas	OD	mm					9.5		12.7		
	Piping length	OU - IU	Max.	m					20		30	
		System	Chargeless	m	10							
Additional refrigerant charge	Level difference	IU - OU	Max.					15		20		
Power supply	Phase / Frequency / Voltage		Hz / V	1~ / 50 / 220-240								
Current - 50Hz	Maximum fuse amps (MFA)		A					16		20		

(1) EER/COP according to Eurovent 2012, for use outside EU only (2) MFA is used to select the circuit breaker and the ground fault circuit interrupter (earth leakage circuit breaker). For more detailed information on each combination, please refer to the electrical data drawing.

Wall mounted unit

Discreet, modern design for optimal efficiency and comfort thanks to 2 area intelligent eye

- › Discreet, modern design. Its smooth curve blends beautifully with the wall resulting in an unobtrusive presence that matches all interior décors.
- › High quality matt crystal white finish
- › Whisper quiet in operation: the operating of the unit can hardly be heard. The sound pressure level goes down to 19dBA!
- › Ideal for installation in bedrooms (20,25 class) and larger or irregular shaped living areas (35,42,50 class)
- › 2 area intelligent eye: air flow is sent to a zone other than where the person is located at that moment; if no people are detected, the unit will automatically switch over to the energy-efficient setting.
- › Online controller (optional): control your indoor unit from any location with an app, via your local network or internet



Efficiency data			FTXS + RXS		20K + 20L3	25K + 25L3	35K + 35L3	42K + 42L	50K + 50L	60G + 60L	71G + 71F8
Cooling capacity	Min./Nom./Max.	kW			-/2.00/-	-/2.5/-	1.4/3.5/4.0	1.7/4.20/5.0	1.7/5.00/5.3	1.7/6.0/6.7	2.3/7.10/8.5
Heating capacity	Min./Nom./Max.	kW			1.3/2.5/4.3	1.3/2.8/4.7	1.4/4.00/5.2	1.7/5.40/6.0	1.7/5.80/6.5	1.7/7.0/8.0	2.3/8.20/10.2
Power input	Cooling	Min./Nom./Max.			0.320/0.455	0.320/0.593	0.350/0.860	0.320/1.253	0.350/1.506	0.440/1.990	0.570/2.350
	Heating	Min./Nom./Max.			/0.760	/1.000	/1.190	/2.330	/1.810	/2.400	/3.200
Seasonal efficiency (according to EN14825)	Cooling	Energy label			A++						A
		Pdesign			2.00	2.50	3.50	4.20	5.00	6.00	7.10
	Heating (Average climate)	SEER			7.40	7.90	7.47	6.80		5.58	5.28
		Annual energy consumption			95	111	164	216	257	376	471
Nominal efficiency	Cooling	Energy label			A++						A
		Pdesign			2.30	2.50	3.60	4.00	4.60	4.80	6.20
	Heating	SEER			4.77	4.78	4.85	4.20		3.89	3.81
		Annual energy consumption			675	732	1,039	1,334	1,535	1,728	2,276
Annual energy consumption	Cooling/Heating	EER			4.39	4.21	3.89	3.35	3.32	3.02	
		COP			4.72	4.67	4.76	4.12	4.00	3.43	3.22
		Energy label			228	297	450	627	753	995	1,175
					A/A			B/B			C/C

Indoor unit			FTXS	CTXS15K	CTXS35K	20K	25K	35K	42K	50K	60G	71G
Dimensions	Unit	HeightxWidthxDepth	289x780x215				298x900x215			290x1,050x250		
Weight	Unit	kg	8				11			12		
Air filter	Type		Removable / washable / mildew proof									
Fan - Air flow rate	Cooling	High/Nom./Low/ Silent operation	m³/min	7.9/6.3/ 4.7/3.9	9.2/7.2/ 5.2/3.9	8.8/6.7/ 4.7/3.9	9.1/7.0/ 5.0/3.9	11.2/8.5/ 5.8/4.1	11.2/9.1/ 7.0/4.1	11.9/9.6/ 7.4/4.5	16.0/16.0/ 11.3/10.1	17.2/17.2/ 11.5/10.5
	Heating	High/Nom./Low/ Silent operation	m³/min	9.0/7.5/ 6.0/4.3	10.1/8.1/ 6.3/4.3	9.5/7.8/ 6.0/4.3	10.0/8.0/ 6.0/4.3	12.1/9.3/ 6.5/4.2	12.4/10.0/ 7.8/5.2	13.3/10.8/ 8.4/5.5	17.2/14.9/ 12.6/11.3	19.5/16.7/ 14.2/12.6
Sound power level	Cooling		dBA	55	59	58		59		60	63	
	Heating		dBA	58			59		60	59	62	
Sound pressure level	Cooling	High/Nom./Low/ Silent operation	dBA	37/31/25/21	42/35/28/21	40/32/24/19	41/33/25/19	45/37/29/19	45/39/33/21	46/40/34/23	45/41/36/33	46/42/37/34
	Heating	High/Nom./Low/ Silent operation	dBA	38/33/28/21	41/36/30/21	40/34/27/19	41/34/27/19	45/39/29/19	45/39/33/22	47/40/34/24	44/40/35/32	46/42/37/34
Control systems	Infrared remote control		-									
Power supply	Phase / Frequency / Voltage	Hz / V	-			ARC466A6			ARC466A9		ARC452A3	
			1~ / 50 / 220-240									

Outdoor unit			RXS	20L3	25L3	35L3	42L	50L	60L	71F8	
Dimensions	Unit	HeightxWidthxDepth	550x765x285				735x825x300		770x900x320		
Weight	Unit	kg	34				39		47	48	71
Sound power level	Cooling		59		61		62		65		
	Heating		58		59		61		66		
Sound pressure level	Cooling	High/Low/Silent operation	46/-/43		48/-/44		48/44/-		49/46/-		52/-/49
	Heating	High/Low/Silent operation	47/-/44		48/-/45		48/45/-		49/46/-		52/-/49
Operation range	Cooling	Ambient Min.-Max.	°CDB		-10~46						
	Heating	Ambient Min.-Max.	°CWB		-15~18						
Refrigerant	Type/Charge/GWP	kg/TCO ₂ eq	R-410A/1.0/2.1/2,087.5		R-410A/1.2/2.5/2,087.5		R-410A/1.3/2.7/2,087.5		R-410A/1.7/3.5/2,087.5		R-410A/1.5/3.1/2,087.5
Piping connections	Liquid	OD	mm		9.5		12.7		15.9		
	Gas	OD	mm		20		30				
	Piping length	OU - IU	Max.	m	10						
	System	Chargeless	m		0.02 (for piping length exceeding 10m)						
Additional refrigerant charge	Level difference IU - OU	Max.	m		15				20.0		
			Phase / Frequency / Voltage	Hz / V		1~ / 50 / 220-240			1~ / 50 / 220-230-240		1~ / 50 / 220-240
Power supply	Phase / Frequency / Voltage	Hz / V		10		20					
Current - 50Hz	Maximum fuse amps (MFA)	A									

(1) EER/COP according to Eurovent 2012, for use outside EU only (2) MFA is used to select the circuit breaker and the ground fault circuit interrupter (earth leakage circuit breaker). For more detailed information on each combination, please refer to the electrical data drawing.

Wall mounted unit

Discreet wall mounted unit providing high efficiency and comfort

- › SEER / SCOP up to A++
- › Discreet, stylish front panel blends easily with the wall, and matches all interior décors
- › Online controller (optional): control your indoor from any location with an app, via your local network or internet
- › Dry programme allows humidity levels to be reduced without variations in room temperature
- › Up to 2 indoor units can be connected to 1 multi outdoor unit; all indoor units are individually controllable and do not need to be installed in the same room or at the same time



Efficiency data		FTX + RX	20KV + 20K	25KV + 25K	35KV + 35K	50KV + 50K	60KV + 60K	71KV + 71K	
Cooling capacity	Min./Nom./Max.	kW	1.3/2.0/2.6	1.3/2.5/3.0	1.3/3.5/4.0	1.7/5.0/6.0	1.7/6.0/7.0	2.3/7.1/7.3	
Heating capacity	Min./Nom./Max.	kW	1.3/2.5/3.5	1.3/3.0/4.0	1.3/4.0/4.8	1.7/6.0/7.7	1.7/7.0/8.0	2.3/8.2/9.5	
Power input	Cooling	Min./Nom./Max.	kW	0.310/0.503/0.720	0.310/0.661/0.720	0.290/1.020/1.3	0.295/1.397/1.542	0.295/1.644/2.255	
	Heating	Min./Nom./Max.	kW	0.250/0.524/0.950	0.250/0.688/0.950	0.290/0.995/1.290	0.329/1.579/1.565	0.381/1.929/2.380	
Seasonal efficiency (according to EN14825)	Cooling	Energy label	A++					A	
		Pdesign	kW	2.00	2.50	3.50	5.00	6.00	7.10
		SEER		6.66	6.55	6.42	6.59	6.76	5.25
	Heating (Average climate)	Annual energy consumption	kWh	105	134	180	266	311	473
		Energy label	A++			A+			A
		Pdesign	kW	2.20	2.40	2.80	4.60	4.80	6.20
Nominal efficiency	EER	SCOP		4.65	4.61	4.64	4.10	3.81	
		Annual energy consumption	kWh	662	729	845	1,570	1,640	2,278
	COP	EER		3.98	3.78	3.4	3.58	3.65	2.61
		Annual energy consumption	kWh	251	331	510	698	822	1,360
Energy label	Cooling/Heating	A/A					D/D		

Indoor unit		FTX	20KV	25KV	35KV	50KV	60KV	71KV	
Dimensions	Unit	HeightxWidthxDepth	285x770x223			295x990x263			
Weight	Unit	kg	8			12			
Air filter	Type	Removable / washable / mildew proof							
Fan - Air flow rate	Cooling	High/Nom./Low/ Silent operation	m ³ /min	9.9/7.8/5.8/4.8	10.4/8.0/6.1/4.8	11.8/8.2/6.3/4.9	16.0/13.7/11.1/10.1	17.6/14.9/12.2/11.2	17.6/-/-/-
	Heating	High/Nom./Low/ Silent operation	m ³ /min	10.9/8.5/6.4/5.2	11.1/8.5/6.7/5.2	12.8/8.5/6.9/5.2	16.7/14.7/12.2/10.9	18.9/16.7/13.7/12.1	-/-/-/-
Sound power level	Cooling		dB(A)	55		58	59	60	62
	Heating		dB(A)	55		58		59	-
Sound pressure level	Cooling	High/Nom./Low/ Silent operation	dB(A)	39/33/25/20	40/33/26/20	43/34/27/20	43/39/34/31	45/41/36/33	46/42/37/34
	Heating	High/Nom./Low/ Silent operation	dB(A)	39/34/28/23	40/34/28/23	43/35/29/26	42/38/33/30	44/40/35/32	-/-/-/-
Control systems	Infrared remote control	ARC480A11							
	Wired remote control	BRC944B2							
Power supply	Phase / Frequency / Voltage	Hz / V	1~ / 50 / 220-240						

Outdoor unit		RX	20K	25K	35K	50K	60K	71K	
Dimensions	Unit	HeightxWidthxDepth	550x658x275			735x870x320			
Weight	Unit	kg	28			44	49		
Sound power level	Cooling		dB(A)	60	62	61	63	66	
	Heating		dB(A)	61	62		63		
Sound pressure level	Cooling	High	dB(A)	46	48	47	49	52	
	Heating	High	dB(A)	47	48		49		
Operation range	Cooling	Ambient Min.-Max.	°CDB	-10~46					
	Heating	Ambient Min.-Max.	°CWB	-15~24					
Refrigerant	Type/Charge/GWP	kg/TCO ₂ eq	R-410A/0.74/1.5/2,087.5		R-410A/1.0/2.1/2,087.5	R-410A/1.13/2.4/2,087.5	R-410A/1.45/3.0/2,087.5		
Piping connections	Liquid	OD	mm	6.35					
	Gas	OD	mm	9.5			12.7		
	Piping length	OU - IU	Max.	m	15			30	
		System	Chargeless	m	10				
Additional refrigerant charge		kg/m	0.02 (for piping length exceeding 10m)						
Level difference	IU - OU	Max.	m	12			20		
Power supply	Phase / Frequency / Voltage	Hz / V	1~ / 50 / 220-240						
Current - 50Hz	Maximum fuse amps (MFA)	A	16			20			

*Note: blue cells contain preliminary data

(1) EER/COP according to Eurovent 2012, for use outside EU only (2) MFA is used to select the circuit breaker and the ground fault circuit interrupter (earth leakage circuit breaker). For more detailed information on each combination, please refer to the electrical data drawing.

Wall mounted unit

Wall mounted unit providing high efficiency and comfort

- › ECONO mode decreases power consumption so that other appliances that need large power consumption can be used
- › Comfort mode guarantees draught free operation by preventing that warm or cold air is directly blown on to the body
- › Titanium apatite photocatalytic air purification filter removes airborne microscopic particles, powerfully decomposes odours and helps to prevent the propagation of bacteria, viruses, microbes to ensure a steady supply of clean air
- › Online controller (optional): control your indoor from any location with an app, via your local network or internet



Efficiency data		FTX + RX	20J3 + 20K	25J3 + 25K	35J3 + 35K	50GV + 50GV	60GV + 60GVB	71GV + 71GVB	
Cooling capacity	Min./Nom./Max.	kW	1.3/2.0/2.6	1.3/2.5/3.0	1.3/3.3/3.8	1.7/5.0/6.0	1.7/6.0/6.7	2.3/7.10/8.5	
Heating capacity	Min./Nom./Max.	kW	1.3/2.5/3.5	1.3/2.8/4.0	1.3/3.5/4.8	1.7/5.8/7.7	1.7/7.0/8.0	2.3/8.20/10.2	
Power input	Cooling	Min./Nom./Max.	kW	0.310/0.490/0.720	0.310/0.700/1.050	0.290/1.030/1.300	0.440/1.550/2.080	0.440/1.990/2.400	
	Heating	Min./Nom./Max.	kW	0.250/0.590/0.950	0.250/0.690/1.110	0.290/0.930/1.290	0.400/1.600/2.530	0.400/2.040/2.810	
Seasonal efficiency (according to EN14825)	Cooling	Energy label	A++			A+		A	
		Pdesign	kW	2.00	2.50	3.30	5.00	6.00	7.10
		SEER		6.11	6.15		5.63	5.37	4.97
	Heating (Average climate)	Annual energy consumption	kWh	115	143	188	311	391	500
		Energy label	A+					A	
		Pdesign	kW	2.20	2.40	2.80	4.60	4.80	6.20
Nominal efficiency	EER	COP	4.09	3.55	3.21	3.23	3.02		
		Annual energy consumption	kWh	244	352	514	775	995	1,175
	Energy label	Cooling/Heating	A/A				B/B		B/C

Indoor unit		FTX	20J3	25J3	35J3	50GV	60GV	71GV	
Dimensions	Unit	HeightxWidthxDepth	283x770x198			290x1,050x238			
Weight	Unit	kg	7			12			
Air filter	Type	Removable / washable / mildew proof							
Fan - Air flow rate	Cooling	High/Nom./Low/Silent operation	m ³ /min	9.1/7.4/5.9/4.7	9.2/7.6/6.0/4.8	9.3/7.7/6.1/4.9	14.7/14.7/10.3/9.5	16.2/16.2/11.4/10.2	17.4/14.6/11.6/10.6
	Heating	High/Nom./Low/Silent operation	m ³ /min	9.4/7.8/6.3/5.5	9.7/8.0/6.3/5.5	10.1/8.4/6.7/5.7	16.1/13.9/11.5/10.2	17.4/15.1/12.7/11.4	19.7/16.9/14.3/12.7
Sound power level	Cooling		dB(A)	55		58	59	60	63
	Heating		dB(A)	55		58	59	60	63
Sound pressure level	Cooling	High/Nom./Low/Silent operation	dB(A)	39/33/25/22	40/33/26/22	41/34/27/23	43/39/34/31	45/41/36/33	46/42/37/34
	Heating	High/Nom./Low/Silent operation	dB(A)	39/34/28/25	40/34/28/25	41/35/29/26	42/38/33/30	44/40/35/32	46/42/37/34
Control systems	Infrared remote control	ARC433A87			ARC433B70				
Power supply	Phase / Frequency / Voltage	Hz / V	1~ / 50 / 220-240						

Outdoor unit		RX	20K	25K	35K	50GV	60GVB	71GVB
Dimensions	Unit	HeightxWidthxDepth	550x658x275			735x825x300		770x900x320
Weight	Unit	kg	28			48	47	71
Sound power level	Cooling		dB(A)	60		62	63	65
	Heating		dB(A)	61		62	64	66
Sound pressure level	Cooling	High/Low	dB(A)	46/-		48/-	47/44	49/46
	Heating	High/Low	dB(A)	47/-		48/-	48/45	49/46
Operation range	Cooling	Ambient	Min.-Max.	-10~46			-10~46	
	Heating	Ambient	Min.-Max.	-15~18			-10~46	
Refrigerant	Type/Charge/GWP	kg/TCO ₂ eq	R-410A/0.74/1.5/2,087.5		R-410A/1.0/2.1/2,087.5	R-410A/1.5/3.1/2,087.5		R-410A/2.3/4.8/2,087.5
Piping connections	Liquid	OD	6.35					
	Gas	OD	9.5		12.7		15.9	
	Piping length	OU - IU	Max.	15		30		
		System	Chargeless	10				
Additional refrigerant charge	Level difference	IU - OU	0.02 (for piping length exceeding 10m)					
	Max.		12		20			
Power supply	Phase / Frequency / Voltage	Hz / V	1~ / 50 / 220-240					
Current - 50Hz	Maximum fuse amps (MFA)	A	16			20		

(1) EER/COP according to Eurovent 2012, for use outside EU only (2) MFA is used to select the circuit breaker and the ground fault circuit interrupter (earth leakage circuit breaker). For more detailed information on each combination, please refer to the electrical data drawing.

Wall mounted unit

Stylish wall mounted unit for low energy consumption and pleasant comfort

- › Seasonal efficiency values up to A+
- › Stylish, modern casing in white or silver
- › Vertical auto swing moves the discharge flaps up and down for efficient air and temperature distribution throughout the room
- › The infrared remote control is user friendly and equipped with a timer function that enables you to programme the unit to start or stop at your desired time.
- › 24 hour timer can be set to start heating or cooling anytime during a 24 hour period



Efficiency data		FTXK + RXK	25AW + 25A	25AS + 25A	35AW + 35A	35AS + 35A	50AW + 50A	50AS + 50A	60AW + 60A	60AS + 60A
Cooling capacity	Min./Nom./Max.	kW	1.300/2.500/3.000		1.300/3.500/3.800		1.630/5.480/6.200		1.750/6.230/6.500	
Heating capacity	Min./Nom./Max.	kW	1.300/3.300/4.000		1.300/3.600/4.750		1.170/5.620/6.600		1.200/6.400/8.000	
Power input	Cooling	Min./Nom./Max.	0.280/0.731/0.990		0.290/1.075/1.390		0.290/1.700/2.000		0.280/1.931/2.000	
	Heating	Min./Nom./Max.	0.260/0.900/1.100		0.285/0.957/1.480		0.260/1.550/2.510		0.240/1.680/2.000	
Seasonal efficiency (according to EN14825)	Cooling	Energy label	A+							
		Pdesign	2.50		3.50		5.48		6.23	
		SEER	5.66		5.86		5.93		6.09	
	Annual energy consumption	155		209		324		359		
	Heating (Average climate)	Energy label	A+							
		Pdesign	2.40		2.80		3.37		3.80	
SCOP		4.24		4.16		4.01		4.06		
Annual energy consumption	792		945		1,177		1,310			
Nominal efficiency	EER	3.42		3.26		3.22		3.23		
	COP	3.67		3.76		3.63		3.81		
	Annual energy consumption	365		537		851		964		
	Energy label	Cooling/Heating	A/A							

Indoor unit		FTXK	25AW	25AS	35AW	35AS	50AW	50AS	60AW	60AS
Dimensions	Unit	HeightxWidthxDepth	297x890x210				320x1,172x242			
Weight	Unit	kg	9.0				14.0			
Air filter	Type		Saranet							
Fan - Air flow rate	Cooling	Super high/High/Nom./Low/Silent operation	10.68/9.78/7.68/6.06/4.68		11.10/10.14/7.98/6.54/4.68		16.38/15.00/13.32/11.82/10.62		19.92/18.54/16.56/14.34/12.36	
	Heating	Super high/High/Nom./Low/Silent operation	10.68/9.78/7.68/6.06/4.68		11.10/10.14/7.98/6.54/4.68		16.38/15.00/13.32/11.82/10.62		19.92/18.54/16.56/14.34/12.36	
Sound power level	Cooling	dBA	53		54		55		61	
	Heating	dBA	53		54		55		61	
Sound pressure level	Cooling	Super high/High/Nom./Low/Silent operation	41/40/34/29/21		42/41/34/30/22		44/40/38/35/32		46/43/41/37/33	
	Heating	Super high/High/Nom./Low/Silent operation	41/40/34/29/21		42/41/34/30/22		44/40/38/35/32		46/43/41/37/33	
Power supply	Phase / Frequency / Voltage	Hz / V	1~ / 50 / 220-240							

Outdoor unit		RXK	25A	35A	50A	60A	
Dimensions	Unit	HeightxWidthxDepth	550x658x289			628x855x328	
Weight	Unit	kg	24			44	
Sound power level	Cooling	dBA	58			65	
	Heating	dBA	58			65	
Sound pressure level	Cooling	Nom.	45			51	
	Heating	Nom.	45			51	
Operation range	Cooling	Ambient Min.-Max.	10~46			-10~46	
	Heating	Ambient Min.-Max.				-15~18	
Refrigerant	Type/Charge/GWP	kg/TCO ₂ eq	R-410A/0.74/1.5/2,087.5		R-410A/1.25/2.6/2,087.5		
Piping connections	Liquid	OD	6.35			15.90	
	Gas	OD	9.52			12.70	
	Piping length	OU - IU Max.	20			30	
	Level difference	IU - OU Max.	7.5			10	
Power supply	Phase / Frequency / Voltage	Hz / V	1~ / 50 / 220-240				
Current - 50Hz	Maximum fuse amps (MFA)	A	16			20	

(1) EER/COP according to Eurovent 2012, for use outside EU only (2) MFA is used to select the circuit breaker and the ground fault circuit interrupter (earth leakage circuit breaker). For more detailed information on each combination, please refer to the electrical data drawing.

Wall mounted unit

Wall mounted unit for low energy consumption and pleasant comfort

- › Seasonal efficiency values up to A+
- › Flat, stylish front panel blends easily within any interior décor and is more easy to clean
- › The infrared remote control is user friendly and equipped with a timer function that enables you to programme the unit to start or stop at your desired time.
- › Vertical auto swing moves the discharge flaps up and down for efficient air and temperature distribution throughout the room
- › 24 hour timer can be set to start heating or cooling anytime during a 24 hour period



Efficiency data		FTXB + RXB	20C + 20C	25C + 25C	35C + 35C	50C + 50C	60C + 60C	
Cooling capacity	Min./Nom./Max.	kW	1.3/2.0/2.6	1.3/2.5/3.0	1.3/3.3/3.8	1.630/5.480/6.200	1.750/6.230/6.500	
Heating capacity	Min./Nom./Max.	kW	1.3/2.5/3.5	1.3/2.8/4.0	1.3/3.5/4.8	1.170/5.620/6.600	1.200/6.400/7.100	
Power input	Cooling	Min./Nom./Max.	kW	0.310/0.510/0.720	0.310/0.770/1.050	0.290/1.030/1.300	0.280/1.700/1.910	
	Heating	Min./Nom./Max.	kW	0.250/0.600/0.950	0.250/0.700/1.110	0.290/0.940/1.290	0.240/1.500/1.880	
Seasonal efficiency (according to EN14825)	Cooling	Energy label		A+				
		Pdesign	kW	2.00	2.50	3.30	5.48	6.23
		SEER		5.98	6.02	6.05	5.93	6.09
	Heating (Average climate)	Energy label		A+				
		Pdesign	kW	2.20	2.40	2.80	3.64	3.80
		SCOP		4.10	4.01	4.06	4.27	4.06
Nominal efficiency	EER	Annual energy consumption	kWh	117	145	191	324	359
		COP	Annual energy consumption	kWh	751	838	966	1,195
	Annual energy consumption		EER		3.94	3.25	3.21	3.22
		Energy label	Cooling/Heating		4.19	4.01	3.71	3.75
				254	385	514	851	964
								A/A

Indoor unit		FTXB	20C	25C	35C	50C	60C	
Dimensions	Unit	HeightxWidthxDepth	283x770x216			310x1,065x224		
Weight	Unit	kg	8			14		
Air filter	Type		Removable / washable / mildew proof			Saranet		
Fan - Air flow rate	Cooling	Super high/High/Nom./ Low/Silent operation	m ³ /min	-/9.1/7.4/5.9/4.7	-/9.2/7.6/6.0/4.8	-/9.3/7.7/6.1/4.9	16.38/15.00/13.32/11.82/10.62	19.92/18.5/16.56/14.34/12.36
	Heating	Super high/High/Nom./ Low/Silent operation	m ³ /min	-/9.4/7.8/6.3/5.5	-/9.7/8.0/6.3/5.5	-/10.1/8.4/6.7/5.7	16.38/15.00/13.32/11.82/10.62	19.92/18.54/16.56/14.3/12.36
Sound power level	Cooling		dBA	55			55	61
	Heating		dBA	55				-
Sound pressure level	Cooling	Super high/High/Nom./ Low/Silent operation	dBA	-/39/33/25/21	-/40/33/26/21	-/41/34/27/23	44/40/38/35/32	46/43/41/37/33
	Heating	Super high/High/Nom./ Low/Silent operation	dBA	-/39/34/28/25	-/40/34/28/25	-/41/35/29/26	44/40/38/35/32	46/43/41/37/33
Control systems	Infrared remote control		ARC470A1				-	
Power supply	Phase / Frequency / Voltage	Hz / V	1~ / 50 / 220-240					

Outdoor unit		RXB	20C	25C	35C	50C	60C	
Dimensions	Unit	HeightxWidthxDepth	550x658x275			753x855x328		
Weight	Unit	kg	28			44		
Sound power level	Cooling		dBA	60			64	65
	Heating		dBA	61				-
Sound pressure level	Cooling	High/Nom.	dBA	46/-			48/-	
	Heating	High/Nom.	dBA	47/-			48/-	
Operation range	Cooling	Ambient Min.-Max.	°CDB				-10~-46	
	Heating	Ambient Min.-Max.	°CWB				-15~-18	
Refrigerant	Type/Charge/GWP	kg/TCO ₂ eq	R-410A/0.74/1.5/2,087.5		R-410A/1.0/2.1/2,087.5		R-410A/1.45/3.0/2,087.5	
Piping connections	Liquid	OD	mm				6.35	
	Gas	OD	mm				9.5	
	Piping length	OU - IU	Max.	m			15	
		System	Chargeless	m			10	
Level difference	IU - OU	Max.	m			12		
Power supply	Phase / Frequency / Voltage	Hz / V	1~ / 50 / 220-240					
Current - 50Hz	Maximum fuse amps (MFA)	A	16			20		

(1) EER/COP according to Eurovent 2012, for use outside EU only (2) MFA is used to select the circuit breaker and the ground fault circuit interrupter (earth leakage circuit breaker). For more detailed information on each combination, please refer to the electrical data drawing.

The best of two worlds united

Pure comfort and design



Why choose Nexura?

- Unique radiant heat panel that heats up just like a traditional radiator
- Whisper quiet operation down to 19 dBA
- Unobtrusive yet stylish design
- Reduced air flow, creating an even distribution of air through the room

Comfort is key

Nexura makes your world a comfortable one. The coolness of a summer breeze or the cosiness of an extra heat source brings a feeling of well-being to your living space all year round. Its unobtrusive yet stylish design with a front panel that radiates additional heat, its low noise level and reduced air flow turn your room into a haven.

Radiant heat panel

To add even more comfort on cold days, the aluminium front panel of the Nexura unit has the capability of warming up, just like a traditional radiator. The result? A comfortable feeling of warm air that envelopes you. And all you have to do to activate this unique feature is push the "radiant" button on your remote control.

Benefits

- › Vertical autoswing
- › Weekly timer
- › Guaranteed operation down to -25°C (with RXLG-M)

Online controller

Always in control, no matter where you are. Control your indoor from any location with an app, via your local network or internet.



Supporting tools

NEW Business portal

- › Experience our new extranet that thinks with you at my.daikin.eu
- › Find information in seconds via a powerful search
- › Customise the options so you see only info relevant for you
- › Access via mobile device or desktop



Internet

- › Visit the website: www.daikineurope.com/minisite/nexura

Literature

- › See all the literature available on www.daikineurope.com/support-and-manuals/catalogues

Floor standing unit with radiant heat panel

Stylish floor standing unit with radiant heat panel for comfortable heat and very low noise

- › The aluminium part of the front panel of the Nexura indoor unit has the capability of warming up, just like a traditional radiator, to add even more comfort on cold days
- › Quiet and discrete, Nexura offers you the best in heating and cooling, in comfort and design
- › The indoor unit distributes air at the sound of a whisper. The noise produced amounts to barely 22dB(A) in cooling and 19dB(A) in radiant heat mode. In comparison, the ambient sound in a quiet room amounts to 40dB(A) on average.
- › Comfortable vertical auto swing ensures draughtfree operation and prevents ceiling soiling
- › Online controller (optional): control your indoor from any location with an app, via your local network or internet
- › Can be installed against a wall or recessed
- › Its low height enables the unit to fit perfectly beneath a window
- › Weekly timer can be set to start heating or cooling anytime on a daily or weekly basis



Efficiency data		FVXG + RXG		25K + 25L	35K + 35L	50K + 50L
Cooling capacity	Min./Nom./Max.	kW		1.3/2.5/3.0	1.4/3.5/3.8	1.7/5.0/5.6
Heating capacity	Min./Nom./Max.	kW		1.3/3.4/4.5	1.4/4.5/5.0	1.7/5.8/8.1
Power input	Cooling	Min./Nom./Max.	kW	0.30/0.54/0.79	0.31/0.94/1.15	4.50/1.51/2.00
	Heating	Min./Nom./Max.	kW	0.29/0.77/1.27	0.29/1.21/1.46	0.50/1.57/2.66
Seasonal efficiency (according to EN14825)	Cooling	Energy label		A++		A
		Pdesign	kW	2.50	3.50	5.00
		SEER		6.53	6.48	5.41
	Heating (Average climate)	Energy label		A++		A+
		Pdesign	kW	2.80	3.10	4.60
		SCOP		4.65	4.00	4.18
Nominal efficiency	EER	Annual energy consumption	kWh	134	189	324
		Energy label		A++		A+
	COP	Pdesign	kW	2.80	3.10	4.60
		Annual energy consumption	kWh	842	1,087	1,543
Energy label	Cooling/Heating	EER		4.63	3.72	3.31
		COP		4.42	3.75	3.69
		Annual energy consumption	kWh	270	470	755
Energy label			A/A			

Indoor unit		FVXG		25K	35K	50K
Dimensions	Unit	HeightxWidthxDepth	mm	600x950x215		
Weight	Unit		kg	22		
Air filter	Type			Removable / washable / mildew proof		
Fan - Air flow rate	Cooling	High/Nom./Low/Silent operation	m ³ /min	8.9/8.9/5.3/4.5	9.1/9.1/5.3/4.5	10.6/10.3/7.3/6.0
	Heating	High/Nom./Low/Silent operation	m ³ /min	9.9/7.8/5.7/4.7	10.2/8.0/5.8/5.0	12.2/10.0/7.8/6.8
Sound power level	Cooling		dBA	52		58
	Heating		dBA	53		60
Sound pressure level	Cooling	High/Nom./Low/Silent operation	dBA	38/32/26/23	39/33/27/24	44/40/36/32
	Heating	High/Nom./Low/Silent operation/Radiant heat	dBA	39/32/26/22/19	40/33/27/23/19	46/40/34/30/26
Control systems	Infrared remote control			ARC466A2		
Power supply	Phase / Frequency / Voltage		Hz / V	1~ / 50 / 220-240		

Outdoor unit		RXG		25L	35L	50L
Dimensions	Unit	HeightxWidthxDepth	mm	550x765x285		735x825x300
Weight	Unit		kg	35		48
Sound power level	Cooling		dBA	61		63
	Heating		dBA	62		63
Sound pressure level	Cooling	High/Silent operation	dBA	46/43		48/44
	Heating	High/Silent operation	dBA	47/44	48/45	48/44
Operation range	Cooling	Ambient Min.-Max.	°CDB	10~46		
	Heating	Ambient Min.-Max.	°CWB	-15~18		
Refrigerant	Type/Charge/GWP		kg/TCO ₂ eq	R-410A/1.05/2.2/2,087.5		R-410A/1.6/3.3/2,087.5
Piping connections	Liquid	OD	mm	6.35		
	Gas	OD	mm	9.5		12.7
	Piping length	OU - IU Max.	m	20		30
Additional refrigerant charge	System	Chargeless	m	10		
	Level difference	IU - OU Max.	kg/m	0.02 (for piping length exceeding 10m)		
	Power supply	Phase / Frequency / Voltage	Hz / V	1~ / 50 / 220-240		
Current - 50Hz	Maximum fuse amps (MFA)		A	16		20

(1) EER/COP according to Eurovent 2012, for use outside EU only (2) MFA is used to select the circuit breaker and the ground fault circuit interrupter (earth leakage circuit breaker). For more detailed information on each combination, please refer to the electrical data drawing.

Floor standing unit

Floor standing unit for optimal heating comfort thanks to dual airflow

- › Its low height enables the unit to fit perfectly beneath a window
- › Can be installed against a wall or recessed
- › Vertical auto swing moves the discharge flaps up and down for efficient air and temperature distribution throughout the room
- › Online controller (optional): control your indoor from any location with an app, via your local network or internet

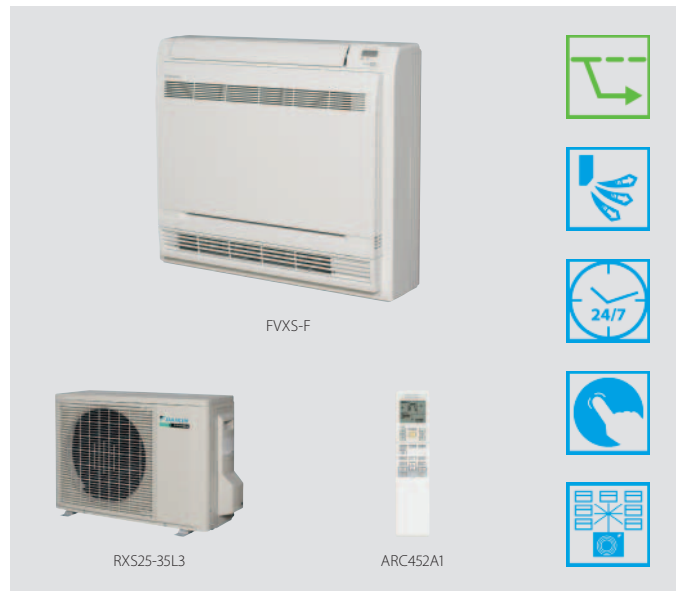

Efficiency data		FVXS + RXS	25F + 25L3	35F + 35L3	50F + 50L	
Cooling capacity	Min./Nom./Max.	kW	1.3/2.5/3.0	1.4/3.5/3.8	1.4/5.0/5.6	
Heating capacity	Min./Nom./Max.	kW	1.3/3.4/4.5	1.4/4.5/5.0	1.4/5.8/8.1	
Power input	Cooling	Min./Nom./Max.	0.300/0.606/0.920	0.300/1.060/1.250	0.500/1.550/2.000	
	Heating	Min./Nom./Max.	0.290/0.770/1.390	0.310/1.190/1.880	0.500/1.600/2.600	
Seasonal efficiency (according to EN14825)	Cooling	Energy label		A+		
		Pdesign	kW	2.50	3.50	5.00
		SEER		5.74	5.60	5.89
		Annual energy consumption	kWh	152	219	297
	Heating (Average climate)	Energy label		A+		A
		Pdesign	kW	2.60	2.90	4.20
		SCOP		4.56	3.93	3.80
		Annual energy consumption	kWh	798	1,033	1,546
Nominal efficiency	EER		4.12	3.30	3.23	
	COP		4.42	3.78	3.63	
	Annual energy consumption	kWh	303	530	775	
	Energy label	Cooling/Heating		A/A		

Indoor unit		FVXS	25F	35F	50F	
Dimensions	Unit	HeightxWidthxDepth	mm			
			600x700x210			
Weight	Unit		kg			
			14			
Air filter	Type		Removable / washable / mildew proof			
Fan - Air flow rate	Cooling	High/Nom./Low/Silent operation	m ³ /min	8.2/8.2/4.8/4.1	8.5/8.5/4.9/4.5	10.7/10.7/7.8/6.6
	Heating	High/Nom./Low/Silent operation	m ³ /min	8.8/6.9/5.0/4.4	9.4/7.3/5.2/4.7	11.8/10.1/8.5/7.1
Sound power level	Cooling		dBA	52	60	
	Heating		dBA	52	60	
Sound pressure level	Cooling	High/Nom./Low/Silent operation	dBA	38/32/26/23	39/33/27/24	44/40/36/32
	Heating	High/Nom./Low/Silent operation	dBA	38/32/26/23	39/33/27/24	45/40/36/32
Control systems	Infrared remote control		ARC452A1			
Power supply	Phase / Frequency / Voltage	Hz / V	1~ / 50 / 220-240			

Outdoor unit		RXS	25L3	35L3	50L	
Dimensions	Unit	HeightxWidthxDepth	mm		735x825x300	
			550x765x285			
Weight	Unit		kg		47	
			34			
Sound power level	Cooling		dBA	59	62	
	Heating		dBA	59	62	
Sound pressure level	Cooling	High/Low/Silent operation	dBA	46/-/43	48/-/44	48/44/-
	Heating	High/Low/Silent operation	dBA	47/-/44	48/-/45	48/45/-
Operation range	Cooling	Ambient Min.-Max.	°CDB	-10~-46		
	Heating	Ambient Min.-Max.	°CWB	-15~-18		
Refrigerant	Type/Charge/GWP	kg/TCO ₂ eq	R-410A/1.0/2.1/2,087.5	R-410A/1.2/2.5/2,087.5	R-410A/1.7/3.5/2,087.5	
Piping connections	Liquid	OD	mm		6.35	
	Gas	OD	mm		9.5	
	Piping length	OU - IU	Max.	m		20
		System	Chargeless	m		10
	Additional refrigerant charge		kg/m	0.02 (for piping length exceeding 10m)		0.020 (for piping length exceeding 10m)
	Level difference IU - OU	Max.	m		20.0	
Power supply	Phase / Frequency / Voltage	Hz / V	1~ / 50 / 220-240		1~ / 50 / 220-230-240	
Current - 50Hz	Maximum fuse amps (MFA)	A	10		20	

(1) EER/COP according to Eurovent 2012, for use outside EU only (2) MFA is used to select the circuit breaker and the ground fault circuit interrupter (earth leakage circuit breaker). For more detailed information on each combination, please refer to the electrical data drawing.

Flexi type unit

Flexible unit, ideal for rooms without false ceiling, can fit on either ceiling or wall

- › Can fit on either ceiling or lower wall; its low height enables the unit to fit beneath a window
- › Vertical auto swing moves the discharge flaps up and down for efficient air and temperature distribution throughout the room
- › Home leave operation maintains the indoor temperature at your specified comfort level during absence, thus saving energy
- › Online controller (optional): control your indoor from any location with an app, via your local network or internet



Efficiency data		FLXS + RXS	25B + 25L3	35B9 + 35L3	50B + 50L	60B	
Cooling capacity	Min./Nom./Max.	kW	1.2/2.5/3.0	-/3.5/-	0.9/4.9/5.3	-	
Heating capacity	Min./Nom./Max.	kW	1.2/3.4/4.5	1.4/4.0/5.0	0.9/6.1/7.5	-	
Power input	Cooling	Min./Nom./Max.	kW	0.300/0.668/0.860	0.300/1.215/1.260	0.450/1.720/1.950	-
	Heating	Min./Nom./Max.	kW	0.290/0.960/1.490	0.290/1.120/1.850	0.310/1.820/3.540	-
Seasonal efficiency (according to EN14825)	Cooling	Energy label		A	B	A	Only available in multi model application
		Pdesign	kW	2.50	3.50	4.90	
		SEER		5.19	4.87	5.25	
	Heating (Average climate)	Energy label		A			
		Pdesign	kW	2.50	2.90	4.20	
		SCOP		3.80			
Nominal efficiency	EER		3.74	2.88	2.85		
		COP		3.54	3.57	3.35	
	Annual energy consumption	kWh	334	608	860		
	Energy label	Cooling/Heating		A/B	B/A	C/C	

Indoor unit		FLXS	25B	35B9	50B	60B	
Dimensions	Unit	HeightxWidthxDpeth	mm				
			490x1,050x200				
Weight	Unit		kg		16	17	
Air filter	Type		Removable / washable / mildew proof				
Fan - Air flow rate	Cooling	High/Nom./Low/Silent operation	m³/min	7.6/7.6/6.0/5.2	8.6/7.6/6.6/5.6	11.4/11.4/8.5/7.5	12.0/10.7/9.3/8.3
	Heating	High/Nom./Low/Silent operation	m³/min	9.2/8.3/7.4/6.6	12.8/10.4/8.0/7.2	12.1/9.8/7.5/6.8	12.8/10.6/8.4/7.5
Sound power level	Cooling		dBA	51	53	60	
	Heating		dBA	51	59	59	
Sound pressure level	Cooling	High/Nom./Low/Silent operation	dBA	37/34/31/28	38/35/32/29	47/43/39/36	48/45/41/39
	Heating	High/Nom./Low/Silent operation	dBA	37/34/31/29	46/36/33/30	46/41/35/33	47/42/37/34
Control systems	Infrared remote control		ARC433B67				
Power supply	Phase / Frequency / Voltage	Hz / V	1~ / 50/60 / 220-240/220-230	1~ / 50 / 220-240	1~ / 50/60 / 220-240/220-230		

Outdoor unit		RXS	25L3	35L3	50L		
Dimensions	Unit	HeightxWidthxDpeth	mm		550x765x285	735x825x300	
Weight	Unit		kg		34	47	
Sound power level	Cooling		dBA	59	61	62	
	Heating		dBA	59	61	62	
Sound pressure level	Cooling	High/Low/Silent operation	dBA	46/-/43	48/-/44	48/44/-	
	Heating	High/Low/Silent operation	dBA	47/-/44	48/-/45	48/45/-	
Operation range	Cooling	Ambient Min.-Max.	°CDB	-10~46			
	Heating	Ambient Min.-Max.	°CWB	-15~18			
Refrigerant	Type/Charge/GWP	kg/TCO ₂ eq	R-410A/1.0/2.1/2,0875	R-410A/1.2/2.5/2,0875	R-410A/1.7/3.5/2,0875		
Piping connections	Liquid	OD	mm				
	Gas	OD	mm		9.5	12.7	
	Piping length	OU - IU	Max.	m		20	30
		System	Chargeless	m			10
	Additional refrigerant charge		kg/m				0.02 (for piping length exceeding 10m)
	Level difference	IU - OU	Max.	m		15	20.0
Power supply	Phase / Frequency / Voltage	Hz / V	1~ / 50 / 220-240		1~ / 50 / 220-230-240		
Current - 50Hz	Maximum fuse amps (MFA)		A				-

(1) EER/COP according to Eurovent 2012, for use outside EU only (2) MFA is used to select the circuit breaker and the ground fault circuit interrupter (earth leakage circuit breaker). For more detailed information on each combination, please refer to the electrical data drawing.

Concealed ceiling unit

Compact concealed ceiling unit, with a height of only 200mm

- Compact dimensions, can easily be mounted in a ceiling void of only 240mm

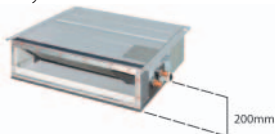

- Discreetly concealed in the ceiling: only the suction and discharge grilles are visible
- Low energy consumption thanks to DC fan motor
- Medium external static pressure up to 40Pa facilitates unit use with flexible ducts of varying lengths



Efficiency data			FDXS + RXS	25F + 25L3	35F + 35L3	50F9 + 50L	60F + 60L
Cooling capacity	Min./Nom./Max.		kW	1.3/2.4/3.0	1.4/3.4/3.8	1.7/5.0/5.3	1.7/6.0/6.5
Heating capacity	Min./Nom./Max.		kW	1.3/3.2/4.5	1.4/4.0/5.0	1.7/5.8/6.0	1.7/7.0/8.0
Power input	Cooling	Nom.	kW	0.641	1.148	1.650	2.060
	Heating	Nom.	kW	0.800	1.150	1.870	2.180
Seasonal efficiency (according to EN14825)	Cooling	Energy label		A+	A	A+	A
		Pdesign	kW	2.40	3.40	5.00	6.00
		SEER		5.63	5.21	5.72	5.51
	Heating (Average climate)	Annual energy consumption	kWh	149	228	306	381
		Energy label		A+		A	
		Pdesign	kW	2.60	2.90	4.00	4.60
Nominal efficiency	EER	SCOP		4.24	3.88	3.93	3.80
		Annual energy consumption	kWh	858	1,047	1,425	1,693
	COP			3.74	2.96	3.03	2.91
		Annual energy consumption	kWh	321	574	825	1,030
Energy label	Cooling/Heating		A/A	B/A	B/D	C/C	

Indoor unit			FDXS	25F	35F	50F9	60F
Dimensions	Unit	HeightxWidthxDepth	mm	200x750x620		200x1,150x620	
Weight	Unit		kg	21		30	
Air filter	Type			Removable / washable / mildew proof			
Fan - Air flow rate	Cooling	High/Nom./Low	m ³ /min	8.7/8.7/7.3		12.0/11.0/10.0	
	Heating	High/Nom./Low	m ³ /min	8.7/8.0/7.3		16.0/14.8/13.5	
Fan - External static pressure	Nom.		Pa	30		40	
Sound power level	Cooling		dBA	53		55	56
	Heating		dBA	53		55	56
Sound pressure level	Cooling	High/Nom./Low	dBA	35/33/27		38/36/30	
	Heating	High/Nom./Low	dBA	35/33/27		38/36/30	
Control systems	Wired remote control			BRC1E52A/B			
Power supply	Phase / Frequency / Voltage		Hz / V	1~ / 50 / 230		1~ / 50 / 220-240	

Outdoor unit			RXS	25L3	35L3	50L	60L	
Dimensions	Unit	HeightxWidthxDepth	mm	550x765x285		735x825x300		
Weight	Unit		kg	34		47	48	
Sound power level	Cooling		dBA	59	61	62		
	Heating		dBA	59	61	62		
Sound pressure level	Cooling	High/Low/Silent operation	dBA	46/-/43	48/-/44	48/44	49/46/-	
	Heating	High/Low/Silent operation	dBA	47/-/44	48/-/45	48/45	49/46/-	
Operation range	Cooling	Ambient	Min.-Max. °CDB	-10~46				
	Heating	Ambient	Min.-Max. °CWB	-15~18				
Refrigerant	Type/Charge/GWP		kg/TCO ₂ eq	R-410A/1.0/2.1/2,0875	R-410A/1.2/2.5/2,0875	R-410A/1.7/3.5/2,0875	R-410A/1.5/3.1/2,0875	
Piping connections	Liquid	OD	mm	6.35				
	Gas	OD	mm	9.5		12.7		
	Piping length	OU - IU	Max.	m	20		30	
		System	Chargeless	m	10			
Additional refrigerant charge			kg/m	0.02 (for piping length exceeding 10m)				
	Level difference	IU - OU	Max.	m	15		20.0	
Power supply	Phase / Frequency / Voltage		Hz / V	1~ / 50 / 220-240		1~ / 50 / 220-230-240		
Current - 50Hz	Maximum fuse amps (MFA)		A	20				

(1) EER/COP according to Eurovent 2012, for use outside EU only (2) MFA is used to select the circuit breaker and the ground fault circuit interrupter (earth leakage circuit breaker). For more detailed information on each combination, please refer to the electrical data drawing.

Small concealed ceiling unit

Designed for hotel applications

- › Compact unit (230mm high & 652mm deep), can easily be mounted in narrow ceiling voids
- › Discretely concealed in the ceiling: only the suction and discharge grilles are visible
- › Whisper quiet operation: down to 28dBA sound pressure level
- › Flexible installation, as the air suction direction can be altered from rear to bottom suction

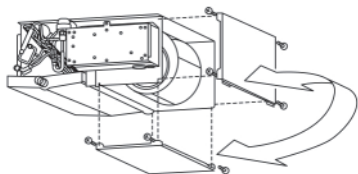

- › For easy mounting, the drain pan can be located to the left or right of the unit

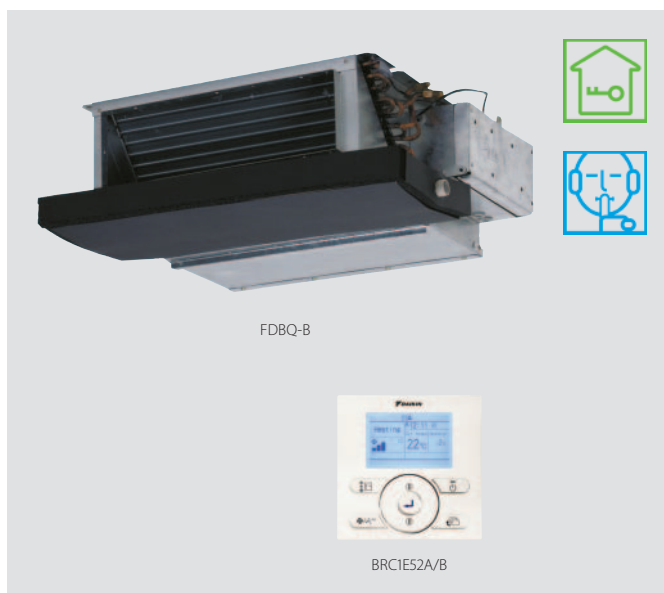

Indoor unit			FDBQ	25B
Dimensions	Unit	HeightxWidthxDepth	mm	230x652x502
Weight	Unit		kg	17.0
Air filter	Type			Resin net with mold resistance
Fan - Air flow rate	Cooling	High/Low	m ³ /min	6.50/5.20
	Heating	High/Low	m ³ /min	6.95/5.20
Sound power level	Cooling		dBA	55
	Heating		dBA	55
Sound pressure level	Cooling	High/Low	dBA	35.0/28.0
	Heating	High/Low	dBA	35.0/29.0
Control systems	Wired remote control			BRC1D52 / BRC1E52A/B
Power supply	Phase / Frequency / Voltage		Hz / V	1~ / 50 / 230

Outdoor unit				
Dimensions	Unit	HeightxWidthxDepth	mm	
Weight	Unit		kg	
Sound power level	Cooling		dBA	
Sound pressure level	Cooling	Nom.	dBA	
	Heating	Nom.	dBA	
Operation range	Cooling	Ambient	Min.-Max. °CDB	
	Heating	Ambient	Min.-Max. °CWB	
Refrigerant	Type/Charge/GWP		kg/TCO ₂ eq	
Piping connections	Liquid	OD	mm	
	Gas	OD	mm	
	Piping length	OU - IU	Max.	m
	Additional refrigerant charge			kg/m
	Level difference	IU - OU	Max.	m
Power supply	Phase / Frequency / Voltage		Hz / V	
Current - 50Hz	Maximum fuse amps (MFA)		A	

only available in multi model application

(1) MFA is used to select the circuit breaker and the ground fault circuit interrupter (earth leakage circuit breaker). For more detailed information on each combination, please refer to the electrical data drawing.

Make all applications possible

Multi model applications

- All indoor units can be individually controlled and do not need to be installed in the same room.
- Combine different types of indoor units: wall mounted, floor standing, ceiling suspended, round flow cassette, concealed ceiling.
- Phased installation possible.

MXS

Installation flexibility

- › A very wide range is available, from 2-port to 5-port units, making all applications possible.
- › Up to 5 indoor units can be connected to 1 multi outdoor unit.
- › Outdoor multi split units are fitted with the Daikin swing compressor, renowned for its low noise and high energy efficiency.
- › The outdoor units are neat and sturdy and can be mounted easily on a roof or terrace or simply placed against an outside wall.

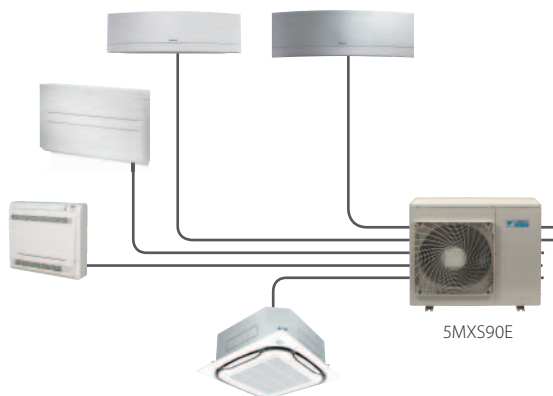

RXYS(C)Q

Installation flexibility

- › Up to 9 indoor units can be connected to 1 VRV outdoor unit
- › Maximum total piping length of 145m offers much more flexibility in the choice of installation position

VRV IV S-series

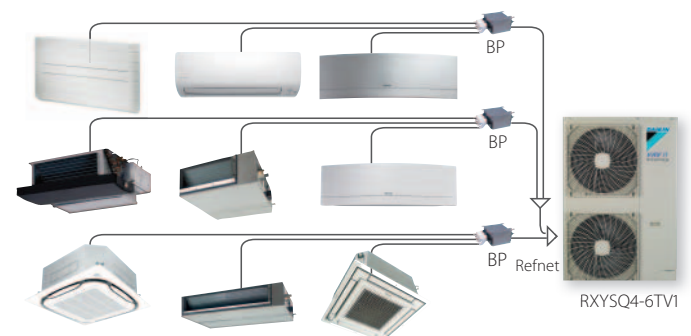
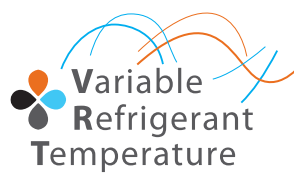

VRV IV S-series compact heat pump

The most compact VRV

- › Compact & lightweight single fan design makes the unit almost unnoticeable
- › Covers all thermal needs of a building via a single point of contact: accurate temperature control, ventilation, air handling units and Biddle air curtains
- › Wide range of indoor units: either connect VRV or stylish indoor units such as Daikin Emura, Nexura ...
- › Incorporates VRV IV standards & technologies: Variable Refrigerant Temperature and full inverter compressors
- › 3 steps in night quiet mode: step 1: 47 dBA, step 2: 44 dBA, step 3: 41 dBA
- › Possibility to limit peak power consumption between 30 and 80%, for example during periods with high power demand
- › Contains all standard VRV features



RXYSCQ-TV1

CONNECTABLE INDOOR UNITS	Wall mounted												Floor standing						Flexi type				Round flow cassette			Fully flat cassette				Concealed ceiling						Ceiling suspended								
	FTXS-L				CTXS-K				FTXS-K				FTXS-G		FVXG-K		FVXS-F		FLXS-B(9)				FCQG-F			FFQ-C				FDXS-F(9)				FDBQ-B / FBQ-D		FHQ-C								
	20	25	35	50	15	35	20	25	35	42	50	60	71	25	35	50	25	35	50	25	35	50	60	35	50	60	25	35	50	60	25	35	50	60	25	35	50	60	35	50	60			
RXYSCQ-TV1	●	●	●	●	●	●	●	●	●	●	●	●	●	●	●	●	●	●	●	●	●	●	●	●	●	●	●	●	●	●	●	●	●	●	●	●	●	●	●	●	●	●	●	●

Outdoor unit		RXYSCQ		4TV1		5TV1		
Capacity range		HP		4		5		
Cooling capacity	Nom.	kW		12.1		14.0		
Heating capacity	Nom.	kW		12.1		14.0		
	Max.	kW		14.2		16.0		
Power input - 50Hz	Cooling	Nom.	kW	3.43		4.26		
	Heating	Nom.	kW	3.18		3.91		
		Max.	kW	4.14		5.00		
EER		kW		3.53		3.29		
COP at nominal capacity		kW		3.81		3.58		
COP at maximum capacity		kW		3.43		3.20		
Maximum number of connectable indoor units						64 (1)		
Indoor index connection	Min.			50		62.5		
	Nom.					-		
	Max.			130		162.5		
Dimensions	Unit	HeightxWidthxDepth		mm		823x940x460		
Weight	Unit			kg		94		
Fan	Air flow rate	Cooling	Nom.	m ³ /min		91		
Sound power level	Cooling	Nom.		dBA		68		
Sound pressure level	Cooling	Nom.		dBA		51		
Operation range	Cooling	Min.~Max.		°CDB		-5~46		
	Heating	Min.~Max.		°CWB		-20~-15.5		
Refrigerant	Type					R-410A		
	Charge			kg		3.7		
				TCO ₂ eq		7.7		
	GWP					2,087.5		
Piping connections	Liquid	OD		mm		9.52		
	Gas	OD		mm		15.9		
	Total piping length	System	Actual	m		-		
Power supply	Phase/Frequency/Voltage				Hz/V		1~/50/220-240	
Current - 50Hz	Maximum fuse amps (MFA)				A		32	

(1) Actual number of units depends on the indoor unit type (VRV DX indoor, RA DX indoor, etc.) and the connection ratio restriction for the system (being; 50% ≤ CR ≤ 130%).
 (2) Contains fluorinated greenhouse gases

Branch provider			BPMKS967B2		BPMKS967B3	
Connectable indoor units			1~2		1~3	
Max. indoor unit connectable capacity			14.2		20.8	
Max. connectable combination			71+71		60+71+71	
Dimensions	Height x Width x Depth	mm	180x294x350			
Weight		kg	7		8	

VRV IV S-series heat pump

Space saving solution without compromising on efficiency

- › Compact & lightweight single fan design makes the unit almost unnoticeable
- › Covers all thermal needs of a building via a single point of contact: accurate temperature control, ventilation, air handling units and Biddle air curtains
- › Wide range of indoor units: either connect VRV or stylish indoor units such as Daikin Emura, Nexura ...
- › Incorporates VRV IV standards & technologies: Variable Refrigerant Temperature and full inverter compressors
- › 3 steps in night quiet mode: step 1: 47 dBA, step 2: 44 dBA, step 3: 41 dBA
- › Possibility to limit peak power consumption between 30 and 80%, for example during periods with high power demand
- › Contains all standard VRV features



CONNECTABLE INDOOR UNITS	Wall mounted												Floor standing						Flexi type				Round flow cassette			Fully flat cassette				Concealed ceiling						Ceiling suspended								
	FTXG-L				CTXS-K		FTXS-K				FTXS-G				FVXG-K		FVXS-F				FLXS-B(9)				FCQG-F			FFQ-C				FDXS-F(9)				FDBQ-B /FBQ-D		FHQ-C						
	20	25	35	50	15	35	20	25	35	42	50	60	71	25	35	50	25	35	50	25	35	50	60	35	50	60	25	35	50	60	25	35	50	60	25	35	50	60	35	50	60			
RXYSQ-TV1	●	●	●	●	●	●	●	●	●	●	●	●	●	●	●	●	●	●	●	●	●	●	●	●	●	●	●	●	●	●	●	●	●	●	●	●	●	●	●	●	●	●	●	●

Outdoor unit		RXYSQ-TV1		4TV1		5TV1		6TV1	
Capacity range		HP		4		5		6	
Cooling capacity	Nom.	kW		12.1		14.0		15.5	
Heating capacity	Nom.	kW		12.1		14.0		15.5	
	Max.	kW		14.2		16.0		18.0	
Power input - 50Hz	Cooling	Nom.	kW	3.03		3.73		4.56	
	Heating	Nom.	kW	2.68		3.27		3.97	
		Max.	kW	3.43		4.09		5.25	
EER		kW		4.00		3.75		3.40	
COP at nominal capacity		kW		4.52		4.28		3.90	
COP at maximum capacity		kW		4.14		3.91		3.43	
Maximum number of connectable indoor units						64 (1)			
Indoor index connection	Min.			50		62.5		70	
	Nom.					-			
	Max.			130		162.5		182	
Dimensions	Unit	HeightxWidthxDepth		mm		1,345x900x320			
Weight	Unit			kg		104			
Fan	Air flow rate	Cooling	Nom.	m ³ /min		106			
Sound power level	Cooling	Nom.		dBA		68		70	
Sound pressure level	Cooling	Nom.		dBA		50		51	
Operation range	Cooling	Min.~Max.		°CDB		-5~46			
	Heating	Min.~Max.		°CWB		-20~15.5			
Refrigerant	Type					R-410A			
	Charge			kg		3.6			
				TCO ₂ eq		7.5			
	GWP					2,087.5			
Piping connections	Liquid	OD		mm		9.52			
	Gas	OD		mm		15.9		19.1	
	Total piping length	System	Actual	m		-			
Power supply	Phase/Frequency/Voltage				Hz/V		1N~/50/220-240		
Current - 50Hz	Maximum fuse amps (MFA)				A		32		

(1) Actual number of units depends on the indoor unit type (VRV DX indoor, RA DX indoor, etc.) and the connection ratio restriction for the system (being; 50% ≤ CR ≤ 130%).
 (2) Contains fluorinated greenhouse gases







Branch provider			BPMKS967B2		BPMKS967B3	
Connectable indoor units			1~2		1~3	
Max. indoor unit connectable capacity			14.2		20.8	
Max. connectable combination			71+71		60+71+71	
Dimensions	Height x Width x Depth	mm			180x294x350	
Weight		kg	7		8	

Siesta

wall mounted units

Siesta

The Siesta range offers a wide variety of wall mounted units with high efficiency values up to A+++. They provide excellent levels of comfort, and several indoor units are connectable to a multi outdoor unit (ATXS-K, ATX-J3, ATX-KV).

Type	Refrigerant	Model	Product name	20	25	35	42	50	60	page	
Wall mounted <i>Siesta</i>	R-410A	Wall mounted unit Siesta, discreet, modern unit for optimal efficiency and comfort thanks to 2 area intelligent eye	ATXS-K		● (multi only)	●	●		●		111
		Wall mounted unit Siesta, providing high efficiency and comfort	ATX-J3		●	●	●				112
			ATX-KV		●	●	●				113
		Wall mounted unit Siesta, offering good value for money and ensuring a steady supply of clean air	ATXN-NB9			● (pair only)	● (pair only)		● (pair only)	● (pair only)	114
		Wall mounted unit Siesta, for low energy consumption and pleasant comfort	ATXB-C			● (pair only)	● (pair only)		● (pair only)	● (pair only)	115
Designed for colder climates		Wall mounted unit Siesta, providing high efficiency and comfort even at low ambient temperatures	ATXL-JV		● (pair only)	● (pair only)				123	



Wall mounted unit

Discreet, modern Siesta unit for optimal efficiency and comfort thanks to 2 area intelligent eye

- › Discreet, modern design. Its smooth curve blends beautifully with the wall resulting in an unobtrusive presence that matches all interior décors.
- › High quality matt crystal white finish
- › Whisper quiet in operation: the operating of the unit can hardly be heard. The sound pressure level goes down to 19dB(A)
- › Ideal for installation in bedrooms (20,25 class) and larger or irregular shaped living areas (35,50 class)
- › 2 area intelligent eye sends the air flow to a zone other than where the person is located at that moment; if no people are detected, the unit will automatically switch over to the energy-efficient setting (35,50 class)
- › Online controller (optional): control your indoor from any location with an app, via your local network or internet



Efficiency data		ATXS + ARXS	20K	25K + 25L3	35K + 35L3	50K + 50L
Cooling capacity	Min./Nom./Max.	kW	Only available in multi model application	1.3/2.5/3.2	1.4/3.5/4.0	1.7/5.00/5.3
Heating capacity	Min./Nom./Max.	kW		1.3/2.8/4.7	1.4/4.00/5.2	1.7/5.80/6.5
Power input	Cooling	Min./Nom./Max.		0.320/0.602/1.000	0.350/0.840/1.190	0.350/1.587/1.810
	Heating	Min./Nom./Max.		0.310/0.620/1.410	0.340/0.840/1.460	0.300/1.450/2.000
Seasonal efficiency (according to EN14825)	Cooling	Energy label		A++		
		Pdesign		2.50	3.50	5.00
	Heating (Average climate)	SEER		7.51	7.10	6.46
		Annual energy consumption		117	173	271
Nominal efficiency	EER	Energy label		A++		A+
		Pdesign		2.50	3.60	4.60
	COP	SCOP	4.68	4.61	4.00	
		Annual energy consumption	747	1,094	1,608	
Energy label	Cooling/Heating		4.15	3.70	3.15	
			4.52	4.76	4.00	
			301	473	794	
			A/A			

Indoor unit		ATXS	20K	25K	35K	50K
Dimensions	Unit	HeightxWidthxDepth	289x780x215		298x900x215	
Weight	Unit	kg	8		11	
Air filter	Type		Removable / washable / mildew proof			
Fan - Air flow rate	Cooling	High/Nom./Low/Silent operation	9.1/7.0/5.0/3.9		11.2/8.5/5.8/4.1	11.9/9.6/7.4/4.5
	Heating	High/Nom./Low/Silent operation	10.0/8.0/6.0/4.3		12.1/9.3/6.5/4.2	13.3/10.8/8.4/5.5
Sound power level	Cooling		56	58	59	60
	Heating		56	58	59	60
Sound pressure level	Cooling	High/Nom./Low/Silent operation	40/32/24/19	41/33/25/19	45/37/29/19	46/40/34/23
	Heating	High/Nom./Low/Silent operation	40/34/27/19	41/34/27/19	45/39/29/19	47/40/34/24
Control systems	Infrared remote control		ARC466A6		ARC466A9	
Power supply	Phase / Frequency / Voltage	Hz / V	1~ / 50 / 220-240			

Outdoor unit		ARXS	25L3	35L3	50L	
Dimensions	Unit	HeightxWidthxDepth	550x765x285		735x825x300	
Weight	Unit	kg	34		47	
Sound power level	Cooling		59	61	62	
	Heating		59	61	62	
Sound pressure level	Cooling	High/Low/Silent operation	46/-/43	48/44/-	48/-/44	
	Heating	High/Low/Silent operation	47/44/-	48/45/-	48/-/45	
Operation range	Cooling	Ambient Min.-Max.	10~46			
	Heating	Ambient Min.-Max.	-15~18			
Refrigerant	Type/Charge/GWP	kg/TCO ₂ eq	R-410A/1.0/2.1/2,087.5	R-410A/1.2/2.5/2,087.5	R-410A/1.7/3.5/2,087.5	
Piping connections	Liquid	OD	6.35			
	Gas	OD	9.5	12.7		
	Piping length	OU - IU	Max.	20	30	
		System	Chargeless	10		
Additional refrigerant charge		kg/m	0.02 (for piping length exceeding 10m)			
	Level difference	IU - OU	Max.	15	20	
Power supply	Phase / Frequency / Voltage	Hz / V	1~ / 50 / 220-240			
Current - 50Hz	Maximum fuse amps (MFA)	A	10	20		

(1) EER/COP according to Eurovent 2012, for use outside EU only (2) MFA is used to select the circuit breaker and the ground fault circuit interrupter (earth leakage circuit breaker). For more detailed information on each combination, please refer to the electrical data drawing.

Wall mounted unit

Siesta wall mounted unit providing high efficiency and comfort

- › Seasonal efficiency values up to A++
- › ECONO mode decreases power consumption so that other appliances that need large power consumption can be used
- › Comfort mode guarantees draught free operation by preventing that warm or cold air is directly blown on to the body
- › Titanium apatite photocatalytic air purification filter removes airborne microscopic particles, powerfully decomposes odours and helps to prevent the propagation of bacteria, viruses, microbes to ensure a steady supply of clean air
- › Online controller (optional): control your indoor from any location with an app, via your local network or internet



Efficiency data		ATX + ARX		20J3 + 20K	25J3 + 25K	35J3 + 35K
Cooling capacity	Min./Nom./Max.	kW		1.3/2.0/2.6	1.3/2.5/3.0	1.3/3.3/3.8
Heating capacity	Min./Nom./Max.	kW		1.3/2.5/3.5	1.3/2.8/4.0	1.3/3.5/4.8
Power input	Cooling	Min./Nom./Max.	kW	0.310/0.490/0.720	0.310/0.700/1.050	0.290/1.030/1.300
	Heating	Min./Nom./Max.	kW	0.250/0.590/0.950	0.250/0.690/1.110	0.290/0.930/1.290
Seasonal efficiency (according to EN14825)	Cooling	Energy label			A++	
		Pdesign	kW	2.00	2.50	3.30
		SEER		6.11		6.15
	Heating (Average climate)	Energy label			A+	
		Pdesign	kW	2.20	2.40	2.80
		SCOP		4.34	4.16	4.14
Nominal efficiency	EER	Annual energy consumption	kWh	115	142	188
		Energy label			A+	
	COP	Pdesign	kW	2.20	2.40	2.80
		Annual energy consumption	kWh	711	809	947
Energy label	Cooling/Heating	Annual energy consumption	kWh	244	352	514
		Energy label			A/A	

Indoor unit		ATX		20J3	25J3	35J3
Dimensions	Unit	HeightxWidthxDepth	mm	283x770x198		
Weight	Unit		kg	7		
Air filter	Type			Removable / washable / mildew proof		
Fan - Air flow rate	Cooling	High/Nom./Low/ Silent operation	m ³ /min	9.1/7.4/5.9/4.7	9.2/7.6/6.0/4.8	9.3/7.7/6.1/4.9
	Heating	Super high/High/ Nom./Low	m ³ /min	9.4/7.8/6.3/5.5	9.7/8.0/6.3/5.5	10.1/8.4/6.7/5.7
Sound power level	Cooling		dBA	55		58
	Heating		dBA	55		58
Sound pressure level	Cooling	High/Nom./Low/ Silent operation	dBA	39/33/25/22	40/33/26/22	41/34/27/23
	Heating	High/Nom./Low/ Silent operation	dBA	39/34/28/25	40/34/28/25	41/35/29/26
Control systems	Infrared remote control			ARC433A89		
Power supply	Phase / Frequency / Voltage		Hz / V	1~ / 50 / 220-240		

Outdoor unit		ARX		20K	25K	35K
Dimensions	Unit	HeightxWidthxDepth	mm	550x658x275		
Weight	Unit		kg	28		
Sound power level	Cooling		dBA	60		62
	Heating		dBA	61		62
Sound pressure level	Cooling	High	dBA	46		48
	Heating	High	dBA	47		48
Operation range	Cooling	Ambient Min.-Max.	°CDB	-10~46		
	Heating	Ambient Min.-Max.	°CWB	-15~18		
Refrigerant	Type/Charge/GWP		kg/TCO ₂ eq	R-410A/0.74/1.5/2,087.5		R-410A/1.0/2.1/2,087.5
Piping connections	Liquid	OD	mm	6.35		
	Gas	OD	mm	9.5		
	Piping length	OU - IU	Max.	m	15	
System		Chargeless	m	10		
Additional refrigerant charge	Level difference	IU - OU	Max.	0.02 (for piping length exceeding 10m)		
	Level difference	IU - OU	Max.	12		
Power supply	Phase / Frequency / Voltage		Hz / V	1~ / 50 / 220-240		
Current - 50Hz	Maximum fuse amps (MFA)		A	16		

(1) EER/COP according to Eurovent 2012, for use outside EU only (2) MFA is used to select the circuit breaker and the ground fault circuit interrupter (earth leakage circuit breaker). For more detailed information on each combination, please refer to the electrical data drawing.

Wall mounted unit

Discreet Siesta wall mounted unit providing high efficiency and comfort

- > SEER / SCOP up to A++
- > Discreet, stylish front panel blends easily with the wall, and matches all interior décors
- > Online controller (optional): control your indoor from any location with an app, via your local network or internet
- > Dry programme allows humidity levels to be reduced without variations in room temperature



Efficiency data		ATX + ARX		20KV + 20K	25KV + 25K	35KV + 35K	
Cooling capacity	Min./Nom./Max.	kW		1.3/2.0/2.6	1.3/2.5/3.0	1.3/3.5/4.0	
Heating capacity	Min./Nom./Max.	kW		1.3/2.5/3.5	1.3/3.0/4.0	1.3/4.0/4.8	
Power input	Cooling	Min./Nom./Max.	kW	0.310/0.504/0.720	0.310/0.661/0.720	0.290/1.020/1.300	
	Heating	Min./Nom./Max.	kW	0.250/0.524/0.950	0.250/0.688/0.950	0.290/0.995/1.290	
Seasonal efficiency (according to EN14825)	Cooling	Energy label		A++			
		Pdesign		kW	2.00	2.50	3.50
		SEER			6.62	6.46	6.40
	Annual energy consumption		kWh	106	135	181	
	Heating (Average climate)	Energy label		A++			
		Pdesign		kW	2.20	2.40	2.80
SCOP			4.64	4.60	4.62		
Annual energy consumption		kWh	664	730	849		
Nominal efficiency	EER			3.97	3.78	3.43	
	COP			4.77	4.36	4.02	
	Annual energy consumption		kWh	252	331	510	
	Energy label		Cooling/Heating	A/A			
Indoor unit			ATX	20KV	25KV	35KV	
Dimensions	Unit	HeightxWidthxDepth	mm	286x770x225			
Weight	Unit		kg	8			
Air filter	Type			Removable / washable / mildew proof			
Fan - Air flow rate	Cooling	High/Nom./Low/ Silent operation	m ³ /min	9.9/7.8/5.8/4.8	10.4/8.0/6.1/4.8	11.8/8.2/6.3/4.9	
	Heating	High/Nom./Low/ Silent operation	m ³ /min	10.9/8.5/6.4/5.2	11.1/8.5/6.7/5.2	12.8/8.5/6.9/5.2	
Sound power level	Cooling		dBA	55		58	
	Heating		dBA	55		58	
Sound pressure level	Cooling	High/Nom./Low/ Silent operation	dBA	39/33/25/20	40/33/26/20	43/34/27/20	
	Heating	High/Nom./Low/ Silent operation	dBA	39/34/28/23	40/34/28/23	43/35/29/26	
Control systems	Infrared remote control			ARC480A11			
	Wired remote control			BRC944B2 / BRC073			
Power supply	Phase / Frequency / Voltage		Hz / V	1~ / 50 / 220-240			
Outdoor unit			ARX	20K	25K	35K	
Dimensions	Unit	HeightxWidthxDepth	mm	550x658x275			
Weight	Unit		kg	28			
Sound power level	Cooling		dBA	60		62	
	Heating		dBA	61		62	
Sound pressure level	Cooling	High	dBA	46		48	
	Heating	High	dBA	47		48	
Operation range	Cooling	Ambient Min.-Max.	°CDB	-10~46			
	Heating	Ambient Min.-Max.	°CWB	-15~18			
Refrigerant	Type/Charge/GWP		kg/TCO ₂ eq	R-410A/0.74/1.5/2,087.5		R-410A/1.0/2.1/2,087.5	
Piping connections	Liquid	OD	mm	6.35			
	Gas	OD	mm	9.5			
	Piping length	OU - IU	Max.	m	15		
		System	Chargeless	m	10		
	Additional refrigerant charge			kg/m	0.02 (for piping length exceeding 10m)		
Level difference		IU - OU	Max.	m			
Power supply	Phase / Frequency / Voltage		Hz / V	1~ / 50 / 220-240			
Current - 50Hz	Maximum fuse amps (MFA)		A	16			

*Note: blue cells contain preliminary data

(1) EER/COP according to Eurovent 2012, for use outside EU only (2) MFA is used to select the circuit breaker and the ground fault circuit interrupter (earth leakage circuit breaker). For more detailed information on each combination, please refer to the electrical data drawing.

Wall mounted unit

Siesta wall mounted unit, offering good value for money and ensuring a steady supply of clean air

- › Seasonal efficiency values up to A+
- › Flat, stylish front panel blends easily within any interior décor and is more easy to clean
- › Vertical auto swing moves the discharge flaps up and down for efficient air and temperature distribution throughout the room
- › The infrared remote control is user friendly and equipped with a timer function that enables you to programme the unit to start or stop at your desired time.
- › 24 hour timer can be set to start heating or cooling anytime during a 24 hour period



Efficiency data		ATXN + ARXN	25NB9 + 25NB9	35NB9 + 35NB9	50NB9 + 50NB9	60NB9 + 60NB9	
Cooling capacity	Min./Nom./Max.	kW	1.300/2.560/3.000	1.300/3.410/3.800	1.630/5.480/6.200	1.750/6.230/6.500	
Heating capacity	Min./Nom./Max.	kW	1.300/2.840/4.000	1.300/3.580/4.750	1.170/5.620/6.600	1.200/6.400/8.000	
Power input	Cooling	Min./Nom./Max.	kW	0.280/0.693/0.990	0.290/1.060/1.390	0.290/1.668/2.000	0.280/1.931/2.000
	Heating	Min./Nom./Max.	kW	0.260/0.700/1.100	0.285/0.950/1.480	0.240/1.550/2.510	0.240/1.680/2.000
Seasonal efficiency (according to EN14825)	Cooling	Energy label	A+				
		Pdesign	kW	2.56	3.41	5.48	6.23
		SEER		5.66	5.86	5.79	5.96
	Heating (Average climate)	Energy label	A+				
		Pdesign	kW	2.41	2.80	3.37	3.80
		SCOP		4.00		4.01	4.06
Nominal efficiency	EER	Annual energy consumption	kWh	159	204	331	366
		Annual energy consumption	kWh	842	981	1,177	1,310
	COP	Annual energy consumption	kWh	347	530	833	964
		Energy label	Cooling/Heating	A/A			
Indoor unit		ATXN	25NB9	35NB9	50NB9	60NB9	
Dimensions	Unit	HeightxWidthxDpeth	288x859x209		310x1,124x237		
Weight	Unit	kg	9.0		14.0		
Air filter	Type	Saranet					
Fan - Air flow rate	Cooling	Super high/High/Nom./Low/Silent operation	m³/min	10.68/9.78/7.68/6.06/4.68	11.10/10.14/7.98/6.54/4.68	16.38/15.00/13.32/11.82/10.62	19.92/18.54/16.56/14.34/12.36
	Heating	Super high/High/Nom./Low/Silent operation	m³/min	10.68/9.78/7.68/6.06/4.68	11.10/10.14/7.98/6.54/4.68	16.38/15.00/13.32/11.82/10.62	19.92/18.54/16.56/14.34/12.36
Sound power level	Cooling		dBA	53	54	55	61
	Heating		dBA	53	54	55	61
Sound pressure level	Cooling	Super high/High/Nom./Low/Silent operation	dBA	41/40/34/29/21	42/41/34/30/22	44/40/38/35/32	46/43/41/37/33
	Heating	Super high/High/Nom./Low/Silent operation	dBA	41/40/34/29/21	42/41/34/30/22	44/40/38/35/32	46/43/41/37/33
Power supply	Phase / Frequency / Voltage	Hz / V	1~ / 50 / 220-240				
Outdoor unit		ARXN	25NB9	35NB9	50NB9	60NB9	
Dimensions	Unit	HeightxWidthxDpeth	550x658x289		628x855x328		
Weight	Unit	kg	24	26	37	44	
Sound power level	Cooling		dBA	58	60	64	65
	Heating		dBA	58	60	64	65
Sound pressure level	Cooling	Nom.	dBA	45	46	51	
	Heating	Nom.	dBA	45	46	51	
Operation range	Cooling	Ambient	Min.-Max.	10~46		-10~46	
	Heating	Ambient	Min.-Max.			-15~18	
Refrigerant	Type/Charge/GWP	kg/TCO ₂ eq	R-410A/0.74/1.5/2,087.5	R-410A/1.00/2.1/2,087.5	R-410A/1.25/2.6/2,087.5	R-410A/1.45/3.0/2,087.5	
Piping connections	Liquid	OD	mm	6.35			
	Gas	OD	mm	9.52	12.70	15.90	
	Piping length	OU - IU	Max.	m	20		
		System	Chargeless	m	7.5		
Level difference	IU - OU	Max.	m	10			
Power supply	Phase / Frequency / Voltage	Hz / V	1~ / 50 / 220-240				
Current - 50Hz	Maximum fuse amps (MFA)	A	16		20		

*Note: blue cells contain preliminary data

(1) EER/COP according to Eurovent 2012, for use outside EU only (2) MFA is used to select the circuit breaker and the ground fault circuit interrupter (earth leakage circuit breaker). For more detailed information on each combination, please refer to the electrical data drawing.

Wall mounted unit

Siesta wall mounted unit for low energy consumption and pleasant comfort

- › Seasonal efficiency values up to A+
- › Flat, stylish front panel blends easily within any interior décor and is easier to clean
- › The infrared remote control is user friendly and equipped with a timer function that enables you to programme the unit to start or stop at your desired time.
- › Vertical auto swing moves the discharge flaps up and down for efficient air and temperature distribution throughout the room
- › 24 hour timer can be set to start heating or cooling anytime during a 24 hour period



Efficiency data		ATXB + ARXB	25C + 25C	35C + 35C	50C + 50C	60C + 60C	
Cooling capacity	Min./Nom./Max.	kW	1.3/2.5/3.0	1.3/3.3/3.8	1.630/5.480/6.200	1.750/6.230/6.500	
Heating capacity	Min./Nom./Max.	kW	1.3/2.8/4.0	1.3/3.5/4.8	1.170/5.620/6.600	1.200/6.400/7.100	
Power input	Cooling	Min./Nom./Max.	kW	0.310/0.770/1.050	0.290/1.030/1.300	0.280/1.700/1.910	0.280/1.931/2.000
	Heating	Min./Nom./Max.	kW	0.250/0.700/1.110	0.290/0.940/1.290	0.240/1.500/1.880	0.240/1.680/2.000
Seasonal efficiency (according to EN14825)	Cooling	Energy label	A+				
		Pdesign	kW	2.50	3.30	5.48	6.23
		SEER		5.93	6.02	5.93	6.09
	Heating (Average climate)	Annual energy consumption	kWh	148	192	324	359
		Energy label	A+				
		Pdesign	kW	2.40	2.80	3.64	3.80
Nominal efficiency	SCOP		4.01	4.04	4.27	4.06	
	Annual energy consumption	kWh	838	970	1,195	1,311	
	EER		3.25	3.21	3.22	3.23	
	COP		4.01	3.71	3.75	3.81	
Annual energy consumption	kWh	385	514	851	964		
Energy label	Cooling/Heating	A/A					

Indoor unit		ATXB	25C	35C	50C	60C	
Dimensions	Unit	HeightxWidthxDepth	283x770x216		310x1,065x224		
Weight	Unit	kg	8		14		
Air filter	Type		Removable / washable / mildew proof		Saranet		
Fan - Air flow rate	Cooling	Super high/High/Nom./Low/Silent operation	m ³ /min	-/9.2/7.6/6.0/4.8	-/9.3/7.7/6.1/4.9	16.38/15.00/13.32/11.82/10.62	19.92/18.5/16.56/14.34/12.36
	Heating	Super high/High/Nom./Low/Silent operation	m ³ /min	-/9.7/8.0/6.3/5.5	-/10.1/8.4/6.7/5.7	16.38/15.00/13.32/11.82/10.62	19.92/18.54/16.56/14.3/12.36
Sound power level	Cooling		dBA	55	58	55	61
	Heating		dBA	55	58	-	-
Sound pressure level	Cooling	Super high/High/Nom./Low/Silent operation	dBA	-/40/33/26/21	-/41/34/27/23	44/40/38/35/32	46/43/41/37/33
	Heating	Super high/High/Nom./Low/Silent operation	dBA	-/40/34/28/25	-/41/35/29/26	44/40/38/35/32	46/43/41/37/33
Control systems	Infrared remote control		ARC470A1		-		
Power supply	Phase / Frequency / Voltage	Hz / V	1~ / 50 / 220-240		-		

Outdoor unit		ARXB	25C	35C	50C	60C	
Dimensions	Unit	HeightxWidthxDepth	550x658x275		753x855x328		
Weight	Unit	kg	28	30	44	44	
Sound power level	Cooling		dBA	60	62	64	65
	Heating		dBA	61	62	-	-
Sound pressure level	Cooling	High/Nom.	dBA	46/-	48/-	-/51	-/51
	Heating	High/Nom.	dBA	47/-	48/-	-/51	-/51
Operation range	Cooling	Ambient Min.-Max.	°CDB	-10~46			
	Heating	Ambient Min.-Max.	°CWB	-15~18			
Refrigerant	Type/Charge/GWP	kg/TCO ₂ eq	R-410A/0.74/1.5/2,087.5	R-410A/1.0/2.1/2,087.5	R-410A/1.45/3.0/2,087.5		
Piping connections	Liquid	OD	mm	6.35			
	Gas	OD	mm	9.5	12.70	15.90	
	Piping length	OU - IU	Max.	m	15	30	30
		System	Chargeless	m	10	7.5	7.5
Level difference	IU - OU	Max.	m	12	10	10	
Power supply	Phase / Frequency / Voltage	Hz / V	1~ / 50 / 220-240				
Current - 50Hz	Maximum fuse amps (MFA)	A	16	20		20	

(1) EER/COP according to Eurovent 2012, for use outside EU only (2) MFA is used to select the circuit breaker and the ground fault circuit interrupter (earth leakage circuit breaker) For more detailed information on each combination, please refer to the electrical data drawing.

Multi model application

- › Outdoor units for multi model application.
- › Outdoor units are fitted with a swing compressor, renowned for its low noise and high energy efficiency
- › Up to 3 indoor units can be connected to 1 Multi outdoor unit; all indoor units are individually controllable and do not need to be installed in the same room or at the same time; they operate simultaneously within the same cooling or heating mode
- › Night quiet mode automatically reduces the operation sound of the outdoor unit by 3dBA during nighttime (multi outdoor units in cooling mode only)
- › Daikin outdoor units are neat, sturdy and can easily be mounted on a roof or terrace or simply placed against an outside wall



	Wall mounted									
	ATXS-K				ATX-J3			ATX-KV		
Connectable indoor units	20	25	35	50	20	25	35	20	25	35
2AMX40G	●	●	●		●	●	●	●	●	●
2AMX50G	●	●	●	●	●	●	●	●	●	●
3AMX52E	●	●	●	●						

Outdoor unit				2AMX40G	2AMX50G	3AMX52E
Dimensions	Unit	HeightxWidthxDepth	mm	550x765x285		735x936x300
Weight	Unit		kg	38	42	49
Sound power level	Cooling		dBA	62	63	59
	Heating		dBA		-	60
Sound pressure level	Cooling	Nom.	dBA	47	48	46
	Heating	Nom.	dBA	48	50	47
Operation range	Cooling	Ambient	Min.~Max. °CDB	10~46		-10~46
	Heating	Ambient	Min.~Max. °CWB	-15~18		
Refrigerant	Type/Charge/GWP		kg/TCO ₂ eq	R-410A/1.20/2.5/2,087.5	R-410A/1.60/3.3/2,087.5	R-410A/2.0/4.2/2,087.5
Piping connections	Liquid	OD	mm	6.35		
	Gas	OD	mm	9.5		
Piping length	OU - IU	Max.	m	20		25
	Additional refrigerant charge		kg/m	0.02 (for piping length exceeding 20m)		0.02 (for piping length exceeding 30m)
Level difference	IU - OU	Max.	m	15		
	IU - IU	Max.	m	7.5		
Power supply	Phase / Frequency / Voltage		Hz / V	1~ / 50 / 220-240		1~ / 50 / 230
Current - 50Hz	Maximum fuse amps (MFA)		A	16		20

Optimised for heating

Why choose Daikin?

- Wide range of indoor units
- Guaranteed heating capacities even with outdoor temperatures down to -25°C.
- Outdoor units delivering leading-edge efficiency with improved defrosting and no ice build up.

Benefits

- > Online controller
- > Guaranteed operation down to -25°C

Designed for living

For most people, total indoor climate control means having the ability to select a desirable temperature for each space in a house and to have that temperature maintained no matter what the temperature outside and this means heating, cooling and high air quality is needed for year round comfort.

For the coldest regions, the outdoor units of our heat pump have been redesigned to withstand extreme weather conditions with excellent energy efficiency ratings.







Designed to operate in a whisper-quiet mode and to distribute purified air in a way that does not produce unpleasant air currents, our indoor units have won prestigious design awards.

Truly, climate control by design.

Online controller

Always in control, no matter where you are. Control your indoor from any location with an app, via your local network or internet.



Type	Model	Product name	25	35	page
Wall mounted	Daikin Emura Design at its best, delivering superior efficiency and comfort	FTXG-LW/S 	● (pair only)	● (pair only)	118
	Wall mounted unit Discreet, modern design for optimal efficiency and comfort thanks to 2 area intelligent eye	FTXLS-K3 	● (pair only)	● (pair only)	119
	Wall mounted unit Providing high efficiency and comfort	FTXL-JV 	● (pair only)	● (pair only)	120
Floor standing	Nexura - floor standing unit with radiant heat panel Stylish floor standing unit with radiant heat panel for comfortable heat and very low noise	FVXG-K 	● (pair only)	● (pair only)	121
	Floor standing unit Floor standing unit for optimal heating comfort thanks to dual airflow	FVXS-F 	● (pair only)	● (pair only)	122
Wall mounted <i>Siesta</i>	Wall mounted unit Siesta wall mounted unit providing high efficiency and comfort	ATXL-JV 	● (pair only)	● (pair only)	123

Wall mounted unit

Design at its best, delivering superior efficiency and comfort, even at ambient temperatures **down to -25°C**

- › Remarkable blend of iconic design and engineering excellence with an elegant finish in matt crystal white
- › Daikin Emura has been awarded with Reddot design award 2014 by an international jury, thanks to its excellent design
- › Designed to perfectly balance technological leadership and the beauty of aerodynamics
- › Online controller (optional): control your indoor from any location with an app, via your local network or internet
- › Whisper quiet in operation: the operating of the unit can hardly be heard. The sound pressure level goes down to 19dB!
- › Guaranteed heating capacity at low ambient temperature, down to -25°C
- › Thanks to the unique free hanging coil technology, the defrost cycle is improved, resulting in lower running costs and no ice buildup



Efficiency data		FTXG + RXLG		25LS + 25M	25LW + 25M	35LS + 35M	35LW + 35M
Cooling capacity	Min./Nom./Max.	kW		1.3/2.5/4.0		1.4/3.5/4.6	
Heating capacity	Min./Nom./Max. /Max. at -15°C	kW		1.0/4.4/6.1/3.6		1.0/5.1/6.7/4.2	
Power input	Cooling	Min./Nom./Max.	kW	0.250/0.680/1.090		0.250/0.980/1.240	
	Heating	Min./Nom./Max.	kW	0.250/1.020/1.610		0.250/1.310/2.070	
Seasonal efficiency (according to EN14825)	Cooling	Energy label		A++			
		Pdesign	kW	2.50		3.50	
		SEER		7.04		6.67	
		Annual energy consumption	kWh	124		184	
	Heating (Average climate)	Energy label		A++			
		Pdesign	kW	2.50		3.00	
		SCOP		4.64		4.60	
		Annual energy consumption	kWh	755		913	
Heating (Cold climate)	SCOP		4.02		3.80		
Nominal efficiency	EER		3.68		3.57		
	COP		4.31		3.89		
	Annual energy consumption	kWh	340		490		
	Energy label	Cooling/Heating	A/A				

Indoor unit		FTXG		25LS	25LW	35LS	35LW
Dimensions	Unit	HeightxWidthxDepth	mm	303x998x212			
Weight	Unit		kg	12			
Air filter	Type	Removable / washable / mildew proof					
Fan - Air flow rate	Cooling	High/Nom./Low/ Silent operation	m ³ /min	8.9/6.6/4.4/2.6		10.9/7.8/4.8/2.9	
		Heating	m ³ /min	11.0/8.6/6.3/3.8		12.4/9.6/6.9/4.1	
Sound power level	Cooling		dBA	54		59	
	Heating		dBA	56		59	
Sound pressure level	Cooling	High/Nom./Low/ Silent operation	dBA	38/32/25/19		45/34/26/20	
	Heating	High/Nom./Low/ Silent operation	dBA	41/34/28/19		45/37/29/20	
Control systems	Infrared remote control		ARC466A1				
Power supply	Phase / Frequency / Voltage		Hz / V	1~ / 50 / 220-240			

Outdoor unit		RXLG		25M	35M	
Dimensions	Unit	HeightxWidthxDepth	mm	550x858x330		
Weight	Unit		kg	40		
Sound power level	Cooling		dBA	61		
	Heating		dBA	61		
Sound pressure level	Cooling	High/Low	dBA	48/44		
	Heating	High/Low	dBA	49/45		
Operation range	Cooling	Ambient	Min.-Max. °CDB	-10~-46		
	Heating	Ambient	Min.-Max. °CWB	-25~-18		
Refrigerant	Type/Charge/GWP		kg/TCO ₂ eq	R-410A/1/2.1/2,087.5		
Piping connections	Liquid	OD	mm	6.35		
	Gas	OD	mm	9.5		
	Piping length	OU - IU	Max.	m	20	
		System	Chargeless	m	10	
	Additional refrigerant charge			kg/m	0.02 (for piping length exceeding 10m)	
Level difference	IU - OU	Max.	m	-		
	IU - IU	Max.	m	15		
Power supply	Phase / Frequency / Voltage		Hz / V	1~ / 50 / 220-240		
Current - 50Hz	Maximum fuse amps (MFA)		A	20		

(1) EER/COP according to Eurovent 2012, for use outside EU only (2) MFA is used to select the circuit breaker and the ground fault circuit interrupter (earth leakage circuit breaker). For more detailed information on each combination, please refer to the electrical data drawing.

Wall mounted unit

Discreet modern design for optimal efficiency and comfort thanks to 2 area intelligent eye, even at ambient temperatures **down to -25°C**

- › High quality matt crystal white finish
- › Excellent air flow and air distribution
- › Whisper quiet in operation: the operating of the unit can hardly be heard. The sound pressure level goes down to 19dBA!
- › New remote control design, also in high quality matt white finish to give a perfect match with the indoor unit
- › Online controller (optional): control your indoor from any location with an app, via your local network or internet
- › Guaranteed heating capacity at low ambient temperature, down to -25°C
- › Thanks to the unique free hanging coil technology, the defrost cycle is improved, resulting in lower running costs and no ice buildup



Efficiency data		FTXLS + RXLS		25K3 + 25M		35K3 + 35M	
Cooling capacity	Min./Nom./Max.	kW		1.6/2.5/4.4		1.7/3.5/5.0	
Heating capacity	Min./Nom./Max./Max. at -15°C	kW		1.0/4.7/6.6/3.98		1.0/5.4/7.2/4.51	
Power input	Cooling	Min./Nom./Max.	kW	0.320/0.669/2.330		0.320/0.951/2.330	
	Heating	Min./Nom./Max.	kW	0.240/1.100/2.360		0.240/1.310/2.880	
Seasonal efficiency (according to EN14825)	Cooling	Energy label		A++			
		Pdesign	kW	2.50		3.50	
		SEER		6.62		6.91	
		Annual energy consumption	kWh	132		177	
	Heating (Average climate)	Energy label		A++			
		Pdesign	kW	3.20		3.80	
		SCOP		4.62		4.60	
		Annual energy consumption	kWh	947		1,147	
Heating (Cold climate)	SCOP		3.76		3.65		
Nominal efficiency	EER		3.74		3.69		
	COP		4.27		4.12		
	Annual energy consumption	kWh	334.5		475.5		
	Energy label	Cooling/Heating			A/A		

Indoor unit			FTXLS	25K3	35K3
Dimensions	Unit	HeightxWidthxDepth	mm	298x900x215	
Weight	Unit		kg	12	
Air filter	Type			Removable / washable / mildew proof	
Fan - Air flow rate	Cooling	High/Nom./Low/ Silent operation	m ³ /min	11.2/9.1/7.0/4.1	
		High/Nom./Low/ Silent operation	m ³ /min	13.3/10.0/7.8/4.2	
Sound power level	Cooling		dBA	59	
	Heating		dBA	62	
Sound pressure level	Cooling	High/Nom./Low/ Silent operation	dBA	45/39/33/21	
		High/Nom./Low/ Silent operation	dBA	47/36/23/19	
Control systems	Infrared remote control			ARC466A9	
Power supply	Phase / Frequency / Voltage		Hz / V	1~ / 50 / 220-240	

Outdoor unit			RXLS	25M	35M	
Dimensions	Unit	HeightxWidthxDepth	mm	550x858x330		
Weight	Unit		kg	40		
Sound power level	Cooling		dBA	61		
	Heating		dBA	61		
Sound pressure level	Cooling	High/Low	dBA	48/44		
	Heating	High/Low	dBA	49/45		
Operation range	Cooling	Ambient	Min.-Max. °CDB	-10~46		
	Heating	Ambient	Min.-Max. °CWB	-25~-18		
Refrigerant	Type/Charge/GWP		kg/TCO ₂ eq	R-410A/1.3/2.7/2,087.5		
Piping connections	Liquid	OD	mm	6.35		
	Gas	OD	mm	9.5		
	Piping length	OU - IU	Max.	m	20	
		System	Chargeless	m	10	
	Additional refrigerant charge		kg/m	0.02 (for piping length exceeding 10m)		
Level difference	IU - OU	Max.	m	-		
	IU - IU	Max.	m	15		
Power supply	Phase / Frequency / Voltage		Hz / V	1~ / 50 / 220-240		
Current - 50Hz	Maximum fuse amps (MFA)		A	20		

(1) EER/COP according to Eurovent 2012, for use outside EU only (2) MFA is used to select the circuit breaker and the ground fault circuit interrupter (earth leakage circuit breaker). For more detailed information on each combination, please refer to the electrical data drawing.

Wall mounted unit

Wall mounted unit providing high efficiency and comfort, even at ambient temperatures **down to -25°C**

- › The unit's compact dimensions makes it ideal for renovation projects, especially for above door installation
- › Excellent air flow and air distribution
- › Online controller (optional): control your indoor from any location with an app, via your local network or internet
- › Guaranteed heating capacity at low ambient temperature, down to -25°C
- › Thanks to the unique free hanging coil technology, the defrost cycle is improved, resulting in lower running costs and no ice buildup
- › Also available in Siesta range, see page 123



Efficiency data		FTXL + RXL	25JV + 25M3	35JV + 35M3
Cooling capacity	Min./Nom./Max.	kW	1.2/2.5/3.4	1.3/3.5/3.8
Heating capacity	Min./Nom./Max. at -15°C	kW	1.1/3.2/5.5/3.24	1.2/3.8/6.0/3.62
Power input	Cooling	Min./Nom./Max.	0.290/0.801/1.300	0.290/1.140/1.300
	Heating	Min./Nom./Max.	0.240/0.722/2.142	0.240/0.902/2.890
Seasonal efficiency (according to EN14825)	Cooling	Energy label	A+	
		Pdesign	2.50	3.50
		SEER	6.01	5.87
	Heating (Average climate)	Energy label	A+	
		Pdesign	2.50	3.00
		SCOP	4.37	4.21
Heating (Cold climate)	SCOP	3.60	3.43	
Nominal efficiency	EER		3.12	3.07
	COP		4.43	4.21
	Annual energy consumption	kWh	400.5	570
	Energy label	Cooling/Heating	B/A	A/A

Indoor unit		FTXL	25JV	35JV
Dimensions	Unit	HeightxWidthxDepth	283x770x198	
Weight	Unit	kg	8	
Air filter	Type		Removable / washable / mildew proof	
Fan - Air flow rate	Cooling	High/Nom./Low/ Silent operation	9.3/7.7/6.1/4.9	
	Heating	High/Nom./Low/ Silent operation	10.1/8.4/6.7/5.7	
Sound power level	Cooling		57	
	Heating		57	
Sound pressure level	Cooling	High/Nom./Low/ Silent operation	41/34/27/23	
	Heating	High/Nom./Low/ Silent operation	41/35/29/26	
Control systems	Infrared remote control		ARC433A87	
Power supply	Phase / Frequency / Voltage	Hz / V	1~ / 50 / 220-240	

Outdoor unit		RXL	25M3	35M3	
Dimensions	Unit	HeightxWidthxDepth	550x858x330		
Weight	Unit	kg	40		
Sound power level	Cooling		61		
	Heating		61		
Sound pressure level	Cooling	High/Low	48/44		
	Heating	High/Low	49/45		
Operation range	Cooling	Ambient	Min.-Max.	°CDB	
	Heating	Ambient	Min.-Max.	°CWB	
Refrigerant	Type/Charge/GWP	kg/TCO ₂ eq	R-410A/1/2.1/2,087.5		
Piping connections	Liquid	OD	6.35		
	Gas	OD	9.5		
	Piping length	OU - IU	Max.	20	
		System	Chargeless	10	
	Additional refrigerant charge		kg/m	0.02 (for piping length exceeding 10m)	
Power supply	Level difference	IU - OU	Max.	m	
	Phase / Frequency / Voltage		Hz / V	1~ / 50 / 220-240	
Current - 50Hz	Maximum fuse amps (MFA)		A		
			20		

(1) EER/COP according to Eurovent 2012, for use outside EU only (2) MFA is used to select the circuit breaker and the ground fault circuit interrupter (earth leakage circuit breaker). For more detailed information on each combination, please refer to the electrical data drawing.

Floor standing unit with radiant heat panel

Stylish floor standing unit with radiant heat panel for comfortable heat and very low noise, even at ambient temperatures **down to -25°C**

- › The aluminium part of the front panel of the Nexura indoor unit has the capability of warming up, just like a traditional radiator, to add even more comfort on cold days
- › Quiet and discrete, Nexura offers you the best in heating and cooling, in comfort and design
- › The indoor unit distributes air at the sound of a whisper. The noise produced amounts to barely 22dB(A) in cooling and 19dB(A) in radiant heat mode. In comparison, the ambient sound in a quiet room amounts to 40dB(A) on average.
- › Comfortable vertical auto swing ensures draughtfree operation and prevents ceiling soiling
- › Online controller (optional): control your indoor from any location with an app, via your local network or internet
- › Can be installed against a wall or recessed
- › Guaranteed heating capacity at low ambient temperature, down to -25°C
- › Thanks to the unique free hanging coil technology, the defrost cycle is improved, resulting in lower running costs and no ice buildup



Efficiency data		FVXG + RXLG		25K + 25M		35K + 35M		
Cooling capacity	Min./Nom./Max.	kW		1.2/2.5/5.1		1.4/3.5/5.6		
Heating capacity	Min./Nom./Max./Max. at -15°C	kW		1.0/4.5/6.5/3.5		1.1/5.6/7.0/4.0		
Power input	Cooling	Min./Nom./Max.	kW	0.250/0.710/1.850		0.250/1.020/2.040		
	Heating	Min./Nom./Max.	kW	0.250/1.160/1.840		0.250/1.550/2.350		
Seasonal efficiency (according to EN14825)	Cooling	Energy label		A++				
		Pdesign	kW	2.50		3.50		
		SEER		6.99		6.59		
	Heating (Average climate)	Annual energy consumption		kWh	131		186	
		Energy label			A+			
		Pdesign	kW	3.00		3.40		
		SCOP		4.25		4.01		
		Annual energy consumption	kWh	989		1,187		
Heating (Cold climate)	SCOP		3.43		3.24			
Nominal efficiency	EER		3.52		3.43			
	COP		3.88		3.61			
	Annual energy consumption	kWh	355		510			
	Energy label	Cooling/Heating			A/A			

Indoor unit		FVXG		25K		35K	
Dimensions	Unit	HeightxWidthxDepth	mm	600x950x215			
Weight	Unit		kg	22			
Air filter	Type	Removable / washable / mildew proof					
Fan - Air flow rate	Cooling	High/Nom./Low/Silent operation	m ³ /min	8.9/8.9/5.3/4.5		9.1/9.1/5.3/4.5	
	Heating	High/Nom./Low/Silent operation	m ³ /min	9.9/7.8/5.7/4.7		10.2/8.0/5.8/5.0	
Sound power level	Cooling		dBA	52			
	Heating		dBA	53			
Sound pressure level	Cooling	High/Nom./Low/Silent operation	dBA	38/32/26/23		39/33/27/24	
	Heating	High/Nom./Low/Silent operation/Radiant heat	dBA	39/32/26/22/19		40/33/27/23/19	
Control systems	Infrared remote control			ARC466A2			
Power supply	Phase / Frequency / Voltage		Hz / V	1~ / 50 / 220-240			

Outdoor unit		RXLG		25M		35M		
Dimensions	Unit	HeightxWidthxDepth	mm	550x858x330				
Weight	Unit		kg	40				
Sound power level	Cooling		dBA	61				
	Heating		dBA	61				
Sound pressure level	Cooling	High/Low	dBA	48/44				
	Heating	High/Low	dBA	49/45				
Operation range	Cooling	Ambient	Min.-Max. °CDB	-10~46				
	Heating	Ambient	Min.-Max. °CWB	-25~-18				
Refrigerant	Type/Charge/GWP		kg/TCO ₂ eq	R-410A/1/2.1/2,087.5				
Piping connections	Liquid	OD	mm	6.35				
	Gas	OD	mm	9.5				
	Piping length	OU - IU	Max.	m	20			
		System	Chargeless	m	10			
Additional refrigerant charge			kg/m	0.02 (for piping length exceeding 10m)				
Level difference	IU - OU	Max.	m	-				
	IU - IU	Max.	m	15				
Power supply	Phase / Frequency / Voltage		Hz / V	1~ / 50 / 220-240				
Current - 50Hz	Maximum fuse amps (MFA)		A	20				

(1) EER/COP according to Eurovent 2012, for use outside EU only (2) MFA is used to select the circuit breaker and the ground fault circuit interrupter (earth leakage circuit breaker). For more detailed information on each combination, please refer to the electrical data drawing.

Floor standing unit

Floor standing unit for optimal heating comfort thanks to dual airflow, even at ambient temperatures **down to -25°C**

- › Its low height enables the unit to fit perfectly beneath a window
- › Can be installed against a wall or recessed
- › Vertical auto swing moves the discharge flaps up and down for efficient air and temperature distribution throughout the room
- › Online controller (optional): control your indoor from any location with an app, via your local network or internet
- › Guaranteed heating capacity at low ambient temperature, down to -25°C
- › Thanks to the unique free hanging coil technology, the defrost cycle is improved, resulting in lower running costs and no ice buildup

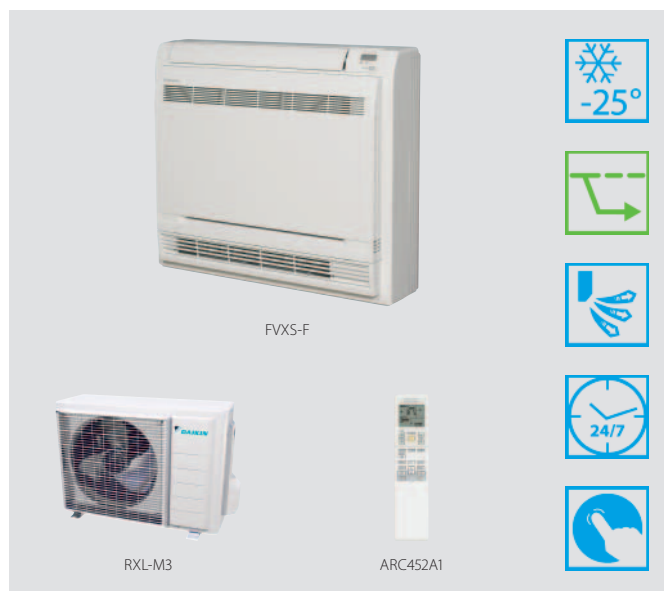

Efficiency data		FVXS + RXL	25F + 25M3	35F + 35M3	
Cooling capacity	Min./Nom./Max.	kW	1.2/2.5/5.1	1.4/3.5/5.6	
Heating capacity	Min./Nom./Max./Max. at -15°C	kW	1.0/4.5/6.5/3.4	1.1/5.6/7.0/3.8	
Power input	Cooling	Min./Nom./Max.	0.250/0.740/1.920	0.250/1.070/2.120	
	Heating	Min./Nom./Max.	0.250/1.190/2.330	0.250/1.620/2.650	
Seasonal efficiency (according to EN14825)	Cooling	Energy label	A		
		Pdesign	2.50	3.50	
		SEER	5.10	5.21	
	Heating (Average climate)	Annual energy consumption	kWh	173	235
		Energy label	A+		
		Pdesign	3.20	3.60	
		SCOP	4.04	3.80	
Heating (Cold climate)	Annual energy consumption	kWh	1,109	1,326	
	SCOP	3.41	3.10		
Nominal efficiency	EER	3.38	3.27		
	COP	3.78	3.46		
	Annual energy consumption	kWh	370	535	
	Energy label	Cooling/Heating	A/A		

Indoor unit		FVXS	25F	35F
Dimensions	Unit	HeightxWidthxDepth	600x700x210	
Weight	Unit	kg	14	
Air filter	Type	Removable / washable / mildew proof		
Fan - Air flow rate	Cooling	High/Nom./Low/ Silent operation	8.2/8.2/4.8/4.1	8.5/8.5/4.9/4.5
	Heating	High/Nom./Low/ Silent operation	8.8/6.9/5.0/4.4	9.4/7.3/5.2/4.7
Sound power level	Cooling	dBA	52	
	Heating	dBA	52	
Sound pressure level	Cooling	High/Nom./Low/ Silent operation	38/32/26/23	39/33/27/24
	Heating	High/Nom./Low/ Silent operation	38/32/26/23	39/33/27/24
Control systems	Infrared remote control	ARC452A1		
Power supply	Phase / Frequency / Voltage	Hz / V	1~ / 50 / 220-240	

Outdoor unit		RXL	25M3	35M3
Dimensions	Unit	HeightxWidthxDepth	550x858x330	
Weight	Unit	kg	40	
Sound power level	Cooling	dBA	61	
	Heating	dBA	61	
Sound pressure level	Cooling	High/Low	48/44	
	Heating	High/Low	49/45	
Operation range	Cooling	Ambient Min.-Max.	°CDB -10~-46	
	Heating	Ambient Min.-Max.	°CWB -25~-18	
Refrigerant	Type/Charge/GWP	kg/TCO ₂ eq	R-410A/1/2.1/2,087.5	
Piping connections	Liquid	OD	6.35	
	Gas	OD	9.5	
	Piping length	OU - IU Max.	30	
	System Chargeless	m	10	
	Additional refrigerant charge	kg/m	0.02 (for piping length exceeding 10m)	
	Level difference	IU - OU Max.	15	
Power supply	Phase / Frequency / Voltage	Hz / V	1~ / 50 / 220-240	
Current - 50Hz	Maximum fuse amps (MFA)	A	20	

(1) EER/COP according to Eurovent 2012, for use outside EU only (2) MFA is used to select the circuit breaker and the ground fault circuit interrupter (earth leakage circuit breaker). For more detailed information on each combination, please refer to the electrical data drawing.

Wall mounted unit

Siesta wall mounted unit providing high efficiency and comfort, even at ambient temperatures **down to -25°C**

- › The unit's compact dimensions makes it ideal for renovation projects, especially for above door installation
- › Excellent air flow and air distribution
- › Online controller (optional): control your indoor from any location with an app, via your local network or internet
- › Guaranteed heating capacity at low ambient temperature, down to -25°C
- › Thanks to the unique free hanging coil technology, the defrost cycle is improved, resulting in lower running costs and no ice buildup



Efficiency data		ATXL + ARXL		25JV + 25M		35JV + 35M	
Cooling capacity	Min./Nom./Max.	kW		1.2/2.5/3.4		1.3/3.5/3.8	
Heating capacity	Min./Nom./Max. at -15°C	kW		1.1/3.2/5.5/3.14		1.2/3.8/6.0/3.54	
Power input	Cooling	Min./Nom./Max. kW		0.29/0.80/1.30		0.29/1.14/1.30	
	Heating	Min./Nom./Max. kW		0.24/0.72/2.14		0.24/0.90/2.89	
Seasonal efficiency (according to EN14825)	Cooling	Energy label		A+			
		Pdesign	kW	2.50		3.50	
		SEER		6.01		5.87	
	Heating (Average climate)	Energy label		A+			
		Pdesign	kW	2.50		3.00	
		SCOP		4.37		4.21	
Heating (Cold climate)	SCOP		3.60		3.43		
Nominal efficiency	EER			3.12		3.07	
	COP			4.43		4.21	
	Annual energy consumption	kWh		400.5		570	
	Energy label	Cooling/Heating				B/A	

Indoor unit		ATXL		25JV		35JV	
Dimensions	Unit	HeightxWidthxDepth mm		283x770x198			
Weight	Unit	kg		8			
Air filter	Type			Removable / washable / mildew proof			
Fan - Air flow rate	Cooling	High/Nom./Low/ Silent operation m³/min		9.3/7.7/6.1/4.9			
	Heating	High/Nom./Low/ Silent operation m³/min		10.1/8.4/6.7/5.7			
Sound power level	Cooling	dBA		57			
	Heating	dBA		57			
Sound pressure level	Cooling	High/Nom./Low/ Silent operation dBA		41/34/27/23			
	Heating	High/Nom./Low/ Silent operation dBA		41/35/29/26			
Control systems	Infrared remote control				ARC433A87		
Power supply	Phase / Frequency / Voltage Hz / V				1~ / 50 / 220-240		

Outdoor unit		ARXL		25M		35M		
Dimensions	Unit	HeightxWidthxDepth mm		550x858x330				
Weight	Unit	kg		40				
Sound power level	Cooling	dBA		61				
	Heating	dBA		61				
Sound pressure level	Cooling	High/Low dBA		48/44w				
	Heating	High/Low dBA		49/45				
Operation range	Cooling	Ambient	Min.-Max. °CDB	-10~-46				
	Heating	Ambient	Min.-Max. °CWB	-25~-18				
Refrigerant	Type/Charge/GWP	kg/TCO ₂ eq		R-410A/1/2.1/2,087.5				
Piping connections	Liquid	OD mm		6.35				
	Gas	OD mm		9.5				
	Piping length	OU - IU	Max. m		15			
		System	Chargeless m		10			
	Additional refrigerant charge	kg/m		0.02 (for piping length exceeding 10m)				
Power supply	Phase / Frequency / Voltage Hz / V				1~ / 50 / 220-240			
Current - 50Hz	Maximum fuse amps (MFA)		A		20			

(1) EER/COP according to Eurovent 2012, for use outside EU only (2) MFA is used to select the circuit breaker and the ground fault circuit interrupter (earth leakage circuit breaker). For more detailed information on each combination, please refer to the electrical data drawing.

Options - Split

		FTXZ-N	FTXJ-MW/S	FTXG-LW/S	FTXM20/25K	CTXS15-35K FTXS20-25K	FTXM35/42/50K	FTXS35-50K	FTXS-G	FTX-J3
Daikin Indoor Units	Wired remote control	BRC073 (3)	BRC073 (3)	BRC073 (3)	BRC073 (3) (5)	BRC073 (3) (5)	BRC073 (3)	BRC073 (3)	BRC073 (3)	BRC073 (3) (5)
	Cord for wired remote control - 3m	BRCW901A03	BRCW901A03	BRCW901A03	BRCW901A03	BRCW901A03	BRCW901A03	BRCW901A03	BRCW901A03	BRCW901A03
	Cord for wired remote control - 8m	BRCW901A08	BRCW901A08	BRCW901A08	BRCW901A08	BRCW901A08	BRCW901A08	BRCW901A08	BRCW901A08	BRCW901A08
	Wireless remote control	-	-	-	-	-	-	-	-	-
	Simplified remote control with mode button	-	-	-	-	-	-	-	-	-
	Simplified remote control without mode button	-	-	-	-	-	-	-	-	-
	Adapter PCB for interlock (key card, ...)	-	-	-	-	-	-	-	-	-
	Wiring adapter normal open contact / normal open pulse contact	KRP413A1S (1)	KRP413A1S (1)	KRP413A1S (1)	KRP413A1S (1) (5)	KRP413A1S (1) (5)	KRP413A1S (1)	KRP413A1S (1)	KRP413A1S (1)	-
	Centralised control board - up to 5 rooms	KRC72 (2)	KRC72 (2)	KRC72 (2)	KRC72 (2)	KRC72 (2)	KRC72 (2)	KRC72 (2)	KRC72 (2)	-
	Anti-theft protection for remote control	-	KKF910A4	KKF910A4	KKF910A4	KKF910A4	KKF910A4	KKF910A4	KKF910A4	KKF917AA4
	Interface adapter for wired remote control	-	-	-	KRP980A1	KRP980A1	-	-	-	KRP980A1
	Wiring adapter for electrical appendices	-	-	-	-	-	-	-	-	-
	Remote sensor	-	-	-	-	-	-	-	-	-
	Installation box for adapter PCB	-	-	-	-	-	-	-	-	-
	Electric box with earth terminal 3 blocks	-	-	-	-	-	-	-	-	-
	Electric box with earth terminal 2 blocks	-	-	-	-	-	-	-	-	-
	Interface adapter for DIII-net	KRP928A2S	KRP928A2S	KRP928A2S	KRP928A2S (5)	KRP928A2S (5)	KRP928A2S	KRP928A2S	KRP928A2S	KRP928A2S (5)
	Online controller	BRP069A42	Standard (8)	BRP069A41	BRP069A43	BRP069A43	BRP069A42	BRP069A42	BRP069A42	BRP069A43
	Modbus gateway	RTD-RA	-	RTD-RA	RTD-RA (5)	RTD-RA (5)	RTD-RA	RTD-RA	RTD-RA	RTD-RA (5)
	KNX gateway	KLIC-DD	-	KLIC-DD	KLIC-DD (5)	KLIC-DD (5)	KLIC-DD	KLIC-DD	KLIC-DD	KLIC-DD (5)
Installation leg	-	-	-	-	-	-	-	-	-	

		ATXS20-25K	ATXS35-50K	ATX-J3
Adapters and controls	Wired remote control	BRC073 (3) (5)	BRC073 (3)	BRC073 (3)
	Cord for wired remote control - 3m	BRCW901A03	BRCW901A03	BRCW901A03
	Cord for wired remote control - 8m	BRCW901A08	BRCW901A08	BRCW901A08
	Wiring adapter normal open contact / normal open pulse contact	KRP413A1S (1) (5)	KRP413AB1S (1)	-
	Centralised control board - up to 5 rooms	KRC72 (2)	KRC72 (2)	-
	Anti-theft protection for remote control	KKF910A4	KKF910A4	KKF910A4
	Interface adapter for wired remote control	KRP980A1	-	KRP980A1
	Interface adapter for DIII-net	KRP928A2S (5)	KRP928A2S	KRP928A2S (5)
	Online controller	BRP069A43	BRP069A42	BRP069A43
	Modbus gateway	RTD-RA (5)	RTD-RA	RTD-RA (5)
KNX gateway	KLIC-DD (5)	KLIC-DD	KLIC-DD (5)	

		RXZ-N	RXJ-M	RXG-L	RXM-L	RXS-L(3)	RXS-F8	RX-K
Others	Air direction adjustment grille	-	-	KPW945A4 (50 class)	-	-	-	-
	Humidifying hose L joint (10 pcs.)	KPMJ983A4L	-	-	-	-	-	-
	L-shape cuffs for humidification (10 pcs)	KPMH950A4L	-	-	-	-	-	-
	Humidifying hose extension set 2m	KPMH974A402	-	-	-	-	-	-
	Hose for humidification (10m)	KPMH974A42	-	-	-	-	-	-

Notes: (1) Wiring adapter supplied by Daikin. Time clock and other devices : to be purchased locally; (2) Wiring adapter is also required for each indoor unit; (3) Cord for wired remote control BRCW901A03 or BRCW901A08 required; (4) Standard there is no remote control delivered with this indoor unit. Wired or wireless control to be ordered separately; (5) Interface adapter KRP980A1, KRP067A41 or KRP980B2 required; (6) Installation box for adapter PCB required; (7) only in combination with simplified remote control BRC2E52C or BRC3E52C . (8) No option needed, functionality is included with the product.

INDOOR UNITS									
FTX-GV	FTX-KV	FTXK-AW/S	FTXB-C	FVXG-K	FVXS-F	FDXS-F(9)	FLXS-B(9)	FTXLS-K3	FTXL-JV
BRC073 (3)	BRC073 (3)	-	-	BRC073 (3)	BRC073 (3)	BRC1D52 BRC1E52A BRC1E52B (4)	BRC073 (3)	BRC073 (3)	BRC073 (3)
BRCW901A03	BRCW901A03	-	-	BRCW901A03	BRCW901A03	-	BRCW901A03	BRCW901A03	BRCW901A03
BRCW901A08	BRCW901A08	-	-	BRCW901A08	BRCW901A08	-	BRCW901A08	BRCW901A08	BRCW901A08
-	-	-	-	-	-	BRC4C65 (4)	-	-	-
-	-	-	-	-	-	BRC2E52C	-	-	-
-	-	-	-	-	-	BRC3E52C	-	-	-
-	-	-	-	-	-	BRP7A54 (6) (7)	-	-	-
KRP413A1S (1)	-	-	-	KRP413A1S (1)	KRP413A1S (1)	-	KRP413A1S (1)	KRP413A1S (1)	-
KRC72 (2)	-	-	-	KRC72 (2)	KRC72 (2)	-	KRC72 (2)	KRC72 (2)	-
KKF917AA4	-	-	-	KKF910A4	-	-	KKF917AA4	KKF910A4	KKF917AA4
-	-	-	-	-	-	-	-	-	KRP980A1
-	-	-	-	-	-	KRP4A54	-	-	-
-	-	-	-	-	-	KRCS01-4	-	-	-
-	-	-	-	-	-	KRP1BA101	-	-	-
-	-	-	-	-	-	KJB311A	-	-	-
-	-	-	-	-	-	KJB212A	-	-	-
KRP928A2S	KRP928A2S	-	-	KRP928A2S	KRP928A2S	-	KRP928A2S	KRP928A2S	-
BRP069A42	BRP069A45	-	-	BRP069A42	BRP069A42	-	BRP069A42	BRP069A42	BRP069A43
RTD-RA	RTD-RA	-	-	RTD-RA	RTD-RA	RTD-NET	RTD-RA	RTD-RA	RTD-RA (5)
KLIC-DD	KLIC-DD	-	-	KLIC-DD	KLIC-DD	KLIC-DI	KLIC-DD	KLIC-DD	KLIC-DD (5)
-	-	-	-	BKS028	-	-	-	-	-

SIESTA INDOOR UNITS			
ATX-KV	ATXN-NB9	ATXB-C	ATXL-JV
BRC073 (3)	-	-	BRC073 (3) (5)
BRCW901A03	-	-	BRCW901A03
BRCW901A08	-	-	BRCW901A08
-	-	-	-
-	-	-	-
-	-	-	-
-	-	-	KRP980A1
KRP928A2S	-	-	-
BRP069A45	-	-	BRP069A43
RTD-RA	-	-	RTD-RA (5)
KLIC-DD	-	-	KLIC-DD (5)

OUTDOOR UNITS												
RX-GV(B)	RXK-A	RXB-C	RXLG-M	RXLS-M	RXL-M(3)	ARXL-M	ARXS-L(3)	ARX-K	ARXN-NB9	ARXB-C	MXS-E /F/G/H/K	AMX-G/E
KPW945A4	-	-	-	-	-	-	-	-	-	-	KPW945A4	-
-	-	-	-	-	-	-	-	-	-	-	-	-
-	-	-	-	-	-	-	-	-	-	-	-	-
-	-	-	-	-	-	-	-	-	-	-	-	-
-	-	-	-	-	-	-	-	-	-	-	-	-

Combination tables

Cooling

Outdoor unit	Indoor unit	Cooling capacity (kW)		Total capacity (kW)			Power input (kW)			Total current (A)			Power factor (%)	EER	Energy label	AEC (kWh)	Seasonal data			
		A room	B room	Min.	Nom.	Max.	Min.	Nom.	Max.	Min.	Nom.	Max.					Label	SEER	Pdesign	AEC
2MXS40H	1.5+1.5	1.5	1.5	1.75	3.0	3.57	0.35	0.66	0.83	1.60	3.1	3.80	94	4.55	A	330	A++	6.13	3.00	172
	1.5+2.0	1.5	2.0	1.75	3.5	3.96	0.35	0.81	0.99	1.60	3.7	4.60	94	4.32	A	405	A++	6.33	3.50	194
	1.5+2.5	1.5	2.5	1.75	4.0	4.22	0.35	1.02	1.12	1.60	4.7	5.20	94	3.92	A	510	A++	6.47	4.00	217
	1.5+3.5	1.2	2.8	1.75	4.0	4.34	0.35	0.99	1.14	1.60	4.6	5.30	94	4.04	A	495	A++	6.42	4.00	218
	2.0+2.0	2.0	2.0	1.75	4.0	4.20	0.31	1.04	1.12	1.40	4.8	5.20	94	3.85	A	520	A++	6.61	4.00	212
	2.0+2.5	1.9	2.2	1.75	4.0	4.30	0.31	1.03	1.17	1.40	4.8	5.40	94	3.88	A	515	A++	6.63	4.00	212
	2.0+3.5	1.8	2.3	1.75	4.0	4.50	0.31	1.00	1.23	1.40	4.6	5.70	94	4.00	A	500	A++	6.52	4.00	215
	2.5+2.5	2.0	2.0	1.75	4.0	4.40	0.31	1.02	1.23	1.40	4.7	5.70	94	3.92	A	510	A++	6.64	4.00	211
	2.5+3.5	1.8	2.2	1.75	4.0	4.60	0.31	0.99	1.31	1.40	4.6	6.10	94	4.04	A	495	A++	6.53	4.00	215

Heating

Outdoor unit	Indoor unit	Heating capacity (kW)		Total capacity (kW)			Power input (kW)			Total current (A)			Power factor (%)	COP	Energy label	Seasonal data				
		A room	B room	Min.	Nom.	Max.	Min.	Nom.	Max.	Min.	Nom.	Max.				Label	SCOP	Pdesign	AEC	Back-up heater capacity at -10°C
2MXS40H	1.5+1.5	1.9	1.9	1.30	3.8	4.26	0.30	0.90	1.11	1.40	4.1	5.10	95	4.22	A	A+	4.06	3.01	1038	0,57
	1.5+2.0	1.7	2.3	1.30	4.0	4.44	0.30	0.95	1.15	1.40	4.3	5.30	95	4.21	A	A+	4.10	3.03	1035	0,59
	1.5+2.5	1.6	2.6	1.30	4.2	4.58	0.30	1.02	1.22	1.40	4.7	5.60	95	4.12	A	A+	4.11	3.03	1032	0,58
	1.5+3.5	1.3	3.1	1.30	4.4	4.70	0.29	1.09	1.20	1.30	5.0	5.50	95	4.04	A	A+	4.16	3.00	1011	0,59
	2.0+2.0	2.1	2.1	1.40	4.2	4.60	0.27	1.01	1.17	1.20	4.6	5.40	95	4.16	A	A+	4.12	3.03	1029	0,58
	2.0+2.5	2.1	2.3	1.40	4.4	4.70	0.27	1.08	1.21	1.20	4.9	5.50	96	4.07	A	A+	4.13	3.03	1028	0,58
	2.0+3.5	2.0	2.4	1.40	4.4	4.70	0.26	1.06	1.19	1.20	4.8	5.40	96	4.15	A	A+	4.14	2.97	1004	0,56
	2.5+2.5	2.2	2.2	1.40	4.4	4.70	0.27	1.07	1.20	1.20	4.8	5.40	96	4.11	A	A+	4.18	3.03	1016	0,58
	2.5+3.5	2.1	2.4	1.40	4.4	4.70	0.26	1.05	1.18	1.20	4.8	5.30	96	4.19	A	A+	4.13	2.96	1003	0,56

- Notes:
- Cooling capacity is based on 27°CDB/19°CWB (Indoor temperature), 35°CDB(Outdoor temperature)
Heating capacity is based on 20°CDB (Indoor temperature), 7°CDB/6°CWB(Outdoor temperature).
 - The total ability of connected indoor unit is up to 6.0kW.
 - It is impossible to connect the indoor unit for one room only.
 - The above is the value for connecting with the following indoor units.
1.5kW: wall mounted CTXS-K series; 2.0, 2.5, 3.5kW: wall mounted FTXS-K series

Combination tables

Cooling

Outdoor unit	Indoor unit	Cooling capacity (kW)		Total capacity (kW)			Power input (kW)			Total current (A)			Power factor (%)	EER	Energy label	AEC (kWh)	Seasonal data			
		A room	B room	Min.	Nom.	Max.	Min.	Nom.	Max.	Min.	Nom.	Max.					Label	SEER	Pdesign	AEC
2MXS50H	1.5+1.5	1.50	1.50	1.88	3.00	3.15	0.33	0.55	0.58	1.60	2.60	2.80	91	5.45	A	275	A++	6.42	3.00	164
	1.5+2.0	1.50	2.00	1.88	3.50	3.73	0.32	0.67	0.75	1.50	3.20	3.60	91	5.22	A	335	A++	6.74	3.50	182
	1.5+2.5	1.50	2.50	1.88	4.00	4.23	0.32	0.87	0.97	1.50	4.20	4.60	91	4.60	A	435	A++	6.68	4.00	210
	1.5+3.5	1.50	3.50	1.88	5.00	5.00	0.32	1.35	1.35	1.50	6.50	6.50	91	3.70	A	675	A++	6.43	5.00	273
	1.5+4.2	1.32	3.68	1.95	5.00	5.37	0.34	1.35	1.67	1.60	6.50	8.00	91	3.70	A	675	A++	6.46	5.00	271
	1.5+5.0	1.15	3.85	1.95	5.00	5.50	0.34	1.35	1.81	1.60	6.50	8.60	91	3.70	A	675	A++	6.45	5.00	272
	2.0+2.0	2.00	2.00	1.95	4.00	5.00	0.34	0.87	1.36	1.60	4.20	6.50	91	4.60	A	435	A++	6.73	4.00	208
	2.0+2.5	2.00	2.50	1.95	4.50	5.10	0.34	1.07	1.45	1.60	5.10	6.90	91	4.21	A	535	A++	6.70	4.50	235
	2.0+3.5	1.82	3.18	1.95	5.00	5.40	0.34	1.35	1.62	1.60	6.50	7.70	91	3.70	A	675	A++	6.50	5.00	270
	2.0+4.2	1.61	3.39	1.95	5.00	5.50	0.34	1.34	1.73	1.60	6.40	8.30	91	3.73	A	670	A++	6.53	5.00	269
	2.0+5.0	1.43	3.57	1.95	5.00	5.50	0.34	1.31	1.71	1.60	6.30	8.20	91	3.82	A	655	A++	6.51	5.00	269
	2.5+2.5	2.50	2.50	1.95	5.00	5.30	0.34	1.38	1.61	1.60	6.60	7.70	91	3.62	A	690	A++	6.61	5.00	265
	2.5+3.5	2.08	2.92	1.95	5.00	5.40	0.34	1.34	1.61	1.60	6.40	7.70	91	3.73	A	670	A++	6.52	5.00	269
	2.5+4.2	1.87	3.13	1.95	5.00	5.50	0.34	1.33	1.72	1.60	6.40	8.20	91	3.76	A	665	A++	6.53	5.00	268
	2.5+5.0	1.67	3.33	1.95	5.00	5.50	0.34	1.30	1.70	1.60	6.20	8.10	91	3.85	A	650	A++	6.53	5.00	269
	3.5+3.5	2.50	2.50	1.98	5.00	5.40	0.34	1.29	1.55	1.60	6.20	7.40	91	3.88	A	645	A++	6.44	5.00	272
	3.5+4.2	2.27	2.73	1.98	5.00	5.50	0.34	1.28	1.65	1.60	6.10	7.90	91	3.91	A	640	A++	6.45	5.00	272
	3.5+5.0	2.06	2.94	1.98	5.00	5.50	0.34	1.27	1.62	1.60	6.10	7.70	91	3.94	A	635	A++	6.44	5.00	272
	4.2+4.2	2.50	2.50	1.98	5.00	5.50	0.34	1.27	1.62	1.60	6.10	7.70	91	3.94	A	635	A++	6.47	5.00	271

Heating

Outdoor unit	Indoor unit	Heating capacity (kW)		Total capacity (kW)			Power input (kW)			Total current (A)			Power factor (%)	COP	Energy label	Seasonal data				
		A room	B room	Min.	Nom.	Max.	Min.	Nom.	Max.	Min.	Nom.	Max.				Label	SCOP	Pdesign	AEC	Back-up heater capacity at -10°C
2MXS50H	1.5+1.5	1.99	1.99	1.17	3.97	4.54	0.22	0.95	1.20	1.1	4.5	5.7	91	4.18	A	A	3.95	3.3	1169	0.64
	1.5+2.0	1.9	2.53	1.17	4.43	4.89	0.22	1.08	1.29	1.1	5.2	6.2	91	4.10	A	A	3.97	3.32	1172	0.64
	1.5+2.5	1.81	3.02	1.17	4.83	5.19	0.23	1.16	1.39	1.1	5.5	6.6	91	4.16	A	A	3.98	3.88	1364	0.75
	1.5+3.5	1.64	3.82	1.17	5.46	5.7	0.23	1.39	1.60	1.1	6.6	7.6	91	3.93	A	A+	4.09	4.25	1454	0.81
	1.5+4.2	1.5	4.2	1.17	5.7	5.96	0.24	1.41	1.53	1.1	6.7	7.3	91	4.04	A	A+	4.06	4.39	1515	0.84
	1.5+5.0	1.32	4.38	1.17	5.7	6.16	0.24	1.44	1.62	1.1	6.9	7.7	91	3.96	A	A+	4.04	4.37	1514	0.83
	2.0+2.0	2.65	2.65	1.18	5.3	5.7	0.23	1.34	1.51	1.1	6.4	7.2	91	3.96	A	A	3.99	3.89	1367	0.75
	2.0+2.5	2.44	3.06	1.18	5.5	5.8	0.23	1.37	1.52	1.1	6.5	7.3	91	4.01	A	A+	4	3.9	1365	0.75
	2.0+3.5	2.04	3.56	1.24	5.6	5.9	0.24	1.39	1.55	1.1	6.6	7.4	91	4.03	A	A+	4.12	4.27	1453	0.81
	2.0+4.2	1.84	3.86	1.25	5.7	6	0.25	1.35	1.50	1.2	6.5	7.2	91	4.22	A	A+	4.09	4.41	1509	0.86
	2.0+5.0	1.63	4.07	1.29	5.7	6.2	0.25	1.38	1.55	1.2	6.6	7.4	91	4.13	A	A+	4.07	4.39	1510	0.86
	2.5+2.5	2.8	2.8	1.18	5.6	5.8	0.23	1.42	1.52	1.1	6.8	7.3	91	3.94	A	A+	4	4.19	1466	0.8
	2.5+3.5	2.38	3.32	1.24	5.7	6	0.25	1.41	1.58	1.2	6.7	7.5	91	4.04	A	A+	4.1	4.41	1507	0.86
	2.5+4.2	2.13	3.57	1.25	5.7	6.1	0.25	1.36	1.51	1.2	6.5	7.2	91	4.19	A	A+	4.11	4.42	1506	0.86
	2.5+5.0	1.9	3.8	1.35	5.7	6.3	0.26	1.35	1.56	1.2	6.5	7.5	91	4.22	A	A+	4.09	4.4	1508	0.86
	3.5+3.5	2.85	2.85	1.3	5.7	6.1	0.25	1.46	1.63	1.2	7	7.8	91	3.90	A	A+	4.3	4.5	1467	0.87
	3.5+4.2	2.59	3.11	1.31	5.7	6.2	0.26	1.38	1.51	1.2	6.6	7.2	91	4.13	A	A+	4.28	4.51	1476	0.87
	3.5+5.0	2.35	3.35	1.35	5.7	6.4	0.27	1.38	1.56	1.3	6.6	7.5	91	4.13	A	A+	4.21	4.49	1493	0.87
	4.2+4.2	2.85	2.85	1.32	5.7	6.3	0.23	1.31	1.50	1.1	6.3	7.2	91	4.35	A	A+	4.29	4.52	1475	0.88

- Notes:
- Cooling capacity is based on 27°CDB/19°CWB (Indoor temperature), 35°CDB (Outdoor temperature). Heating capacity is based on 20°CDB (Indoor temperature), 7°CDB/6°CWB (Outdoor temperature).
 - The total ability of connected indoor unit is up to 8.5kW.
 - It is impossible to connect the indoor unit for one room only.
 - The above is the value for connecting with the following indoor units.
1.5kW: wall mounted CTXS-K series; 2.0, 2.5, 3.5, 4.2, 5.0kW: wall mounted FTXS-K series

Combination tables

Cooling

Outdoor unit	Indoor unit	Cooling capacity (kW)				Total capacity (kW)			Power input (kW)			Total current (A)			Power factor (%)	EER	Energy label	AEC (kWh)	Seasonal data			
		A room	B room	C room	D room	Min.	Nom.	Max.	Min.	Nom.	Max.	Min.	Nom.	Max.					Label	SEER	Pdesign	AEC
3MXS40K	1.5+1.5	1.50	1.50	---	---	1.78	3.00	4.20	0.35	0.63	1.12	1.60	2.80	5.00	98.00	4.76	A	315	A++	6.55	3.00	161
	1.5+2.0	1.50	2.00	---	---	1.78	3.50	4.20	0.35	0.80	1.12	1.50	3.50	4.90	99.00	4.38	A	400	A++	6.77	3.50	182
	1.5+2.5	1.50	2.50	---	---	1.78	4.00	4.20	0.35	0.98	1.12	1.50	4.30	4.90	99.00	4.08	A	490	A++	6.86	4.00	205
	1.5+3.5	1.20	2.80	---	---	1.78	4.00	4.21	0.35	0.98	1.12	1.50	4.30	4.90	99.00	4.08	A	490	A++	6.69	4.00	210
	2.0+2.0	2.00	2.00	---	---	1.88	4.00	4.54	0.35	0.95	1.12	1.50	4.20	4.90	99.00	4.21	A	475	A++	6.90	4.00	203
	2.0+2.5	1.78	2.22	---	---	1.88	4.00	4.54	0.35	0.95	1.12	1.50	4.20	4.90	99.00	4.21	A	475	A++	6.90	4.00	203
	2.0+3.5	1.45	2.55	---	---	1.88	4.00	4.55	0.35	0.95	1.09	1.50	4.20	4.80	99.00	4.21	A	475	A++	6.73	4.00	209
	2.5+2.5	2.00	2.00	---	---	1.88	4.00	4.54	0.35	0.95	1.12	1.50	4.20	4.90	99.00	4.21	A	475	A++	6.90	4.00	203
	2.5+3.5	1.67	2.33	---	---	1.88	4.00	4.54	0.35	0.95	1.12	1.50	4.20	4.90	99.00	4.21	A	475	A++	6.73	4.00	209
	3.5+3.5	2.00	2.00	---	---	1.88	4.00	4.58	0.35	0.95	1.12	1.50	4.20	4.90	99.00	4.21	A	475	A++	6.56	4.00	214
	1.5+1.5+1.5	1.33	1.33	1.33	---	1.80	4.00	4.60	0.35	0.83	0.98	1.50	3.60	4.30	99.00	4.82	A	415	A++	6.97	4.00	201
	1.5+1.5+2.0	1.20	1.20	1.60	---	1.80	4.00	4.60	0.35	0.84	0.98	1.50	3.70	4.30	99.00	4.76	A	420	A++	6.97	4.00	201
	1.5+1.5+2.5	1.09	1.09	1.82	---	1.80	4.00	4.60	0.35	0.84	0.98	1.50	3.70	4.30	99.00	4.76	A	420	A++	6.97	4.00	201
	1.5+1.5+3.5	0.92	0.92	2.15	---	1.80	4.00	4.60	0.37	0.84	0.98	1.60	3.70	4.30	99.00	4.76	A	420	A++	6.80	4.00	206
	1.5+2.0+2.0	1.09	1.45	1.45	---	1.80	4.00	4.60	0.35	0.84	0.98	1.50	3.70	4.30	99.00	4.76	A	420	A++	6.98	4.00	201
	1.5+2.0+2.5	1.00	1.33	1.67	---	1.80	4.00	4.60	0.35	0.84	0.98	1.50	3.70	4.30	99.00	4.76	A	420	A++	6.98	4.00	201
	1.5+2.0+3.5	0.86	1.14	2.00	---	1.80	4.00	4.60	0.37	0.84	0.98	1.60	3.70	4.30	99.00	4.76	A	420	A++	6.81	4.00	206
	1.5+2.5+2.5	0.92	1.54	1.54	---	1.80	4.00	4.60	0.37	0.84	0.98	1.60	3.70	4.30	99.00	4.76	A	420	A++	6.98	4.00	201
	2.0+2.0+2.0	1.33	1.33	1.33	---	1.86	4.00	4.60	0.35	0.81	0.98	1.50	3.60	4.30	99.00	4.94	A	405	A++	7.02	4.00	200
	2.0+2.0+2.5	1.23	1.23	1.54	---	1.86	4.00	4.60	0.35	0.81	0.98	1.50	3.60	4.30	99.00	4.94	A	405	A++	7.02	4.00	200
2.0+2.5+2.5	1.14	1.43	1.43	---	1.95	4.00	4.60	0.37	0.81	0.98	1.60	3.60	4.30	99.00	4.94	A	405	A++	7.02	4.00	200	

Heating

Outdoor unit	Indoor unit	Heating capacity (kW)				Total capacity (kW)			Power input (kW)			Total current (A)			Power factor (%)	COP	Energy label	Seasonal data				
		A room	B room	C room	D room	Min.	Nom.	Max.	Min.	Nom.	Max.	Min.	Nom.	Max.				Label	SCOP	Pdesign	AEC	Back-up heater capacity at -10°C
3MXS40K	1.5+1.5	2.30	2.30	---	---	1.22	4.60	5.00	0.31	1.11	1.29	1.4	4.9	5.7	99	4.14	A	A+	4.09	3.59	1229	0.68
	1.5+2.0	1.97	2.63	---	---	1.22	4.60	5.00	0.31	1.11	1.29	1.4	4.9	5.7	99	4.14	A	A+	4.12	3.61	1227	0.68
	1.5+2.5	1.73	2.88	---	---	1.22	4.60	5.00	0.31	1.10	1.29	1.4	4.8	5.7	99	4.18	A	A+	4.04	4.73	1640	0.91
	1.5+3.5	1.38	3.22	---	---	1.25	4.60	5.02	0.31	1.10	1.29	1.4	4.8	5.7	99	4.18	A	A+	4.17	4.84	1624	0.93
	2.0+2.0	2.30	2.30	---	---	1.28	4.60	5.00	0.31	1.11	1.29	1.4	4.9	5.7	99	4.14	A	A+	4.05	4.75	1641	0.92
	2.0+2.5	2.04	2.56	---	---	1.28	4.60	5.00	0.31	1.10	1.29	1.4	4.8	5.7	99	4.18	A	A+	4.07	4.76	1636	0.92
	2.0+3.5	1.67	2.93	---	---	1.34	4.60	5.02	0.31	1.10	1.29	1.4	4.8	5.7	99	4.18	A	A+	4.23	4.86	1609	0.93
	2.5+2.5	2.30	2.30	---	---	1.28	4.60	5.00	0.31	1.10	1.29	1.4	4.8	5.7	99	4.18	A	A+	4.08	4.77	1636	0.92
	2.5+3.5	1.92	2.68	---	---	1.34	4.60	5.02	0.31	1.10	1.29	1.4	4.8	5.7	99	4.18	A	A+	4.24	4.87	1610	0.93
	3.5+3.5	2.30	2.30	---	---	1.40	4.60	5.04	0.31	1.10	1.28	1.4	4.8	5.6	99	4.18	A	A+	4.37	4.93	1580	0.94
	1.5+1.5+1.5	1.53	1.53	1.53	---	1.32	4.60	5.00	0.32	0.91	1.02	1.4	4.0	4.5	99	5.05	A	A+	4.29	4.93	1609	0.94
	1.5+1.5+2.0	1.38	1.38	1.84	---	1.32	4.60	5.07	0.32	0.91	1.02	1.4	4.0	4.5	99	5.05	A	A+	4.31	4.94	1605	0.95
	1.5+1.5+2.5	1.25	1.25	2.09	---	1.32	4.60	5.07	0.32	0.91	1.02	1.4	4.0	4.5	99	5.05	A	A+	4.31	4.94	1603	0.94
	1.5+1.5+3.5	1.06	1.06	2.48	---	1.32	4.60	5.09	0.32	0.91	1.01	1.4	4.0	4.4	99	5.05	A	A+	4.39	4.95	1578	0.94
	1.5+2.0+2.0	1.25	1.67	1.67	---	1.32	4.60	5.07	0.32	0.91	1.02	1.4	4.0	4.5	99	5.05	A	A+	4.32	4.94	1602	0.94
	1.5+2.0+2.5	1.15	1.53	1.92	---	1.33	4.60	5.07	0.32	0.91	1.02	1.4	4.0	4.5	99	5.05	A	A+	4.36	4.94	1588	0.94
	1.5+2.0+3.5	0.99	1.31	2.30	---	1.33	4.60	5.09	0.32	0.91	1.01	1.4	4.0	4.4	99	5.05	A	A+	4.40	4.95	1575	0.95
	1.5+2.5+2.5	1.06	1.77	1.77	---	1.33	4.60	5.07	0.32	0.91	1.02	1.4	4.0	4.5	99	5.05	A	A+	4.34	4.95	1596	0.95
	2.0+2.0+2.0	1.53	1.53	1.53	---	1.34	4.60	5.07	0.32	0.91	1.02	1.4	4.0	4.5	99	5.05	A	A+	4.34	4.95	1596	0.95
	2.0+2.0+2.5	1.42	1.42	1.77	---	1.34	4.60	5.07	0.32	0.91	1.02	1.4	4.0	4.5	99	5.05	A	A+	4.35	4.95	1594	0.95
2.0+2.5+2.5	1.31	1.64	1.64	---	1.45	4.60	5.07	0.32	0.91	1.02	1.4	4.0	4.5	99	5.05	A	A+	4.36	4.95	1590	0.94	

- Notes:
- Cooling capacity is based on 27°CDB/19°CWB (Indoor temperature), 35°CDB (Outdoor temperature). Heating capacity is based on 20°CDB (Indoor temperature), 7°CDB/6°CWB (Outdoor temperature).
 - The total ability of connected indoor unit is up to 7.0kW.
 - It is impossible to connect the indoor unit for one room only.
 - The above is the value for connecting with the following indoor units.
1.5kW: wall mounted CTXS-K series; 2.0, 2.5, 3.5kW: wall mounted FTXS-K series

Combination tables

Cooling

Outdoor unit	Indoor unit	Cooling capacity (kW)				Total capacity (kW)			Power input (kW)			Total current (A)			Power factor (%)	EER	Energy label	AEC (kWh)	Seasonal data			
		A room	B room	C room	D room	Min.	Nom.	Max.	Min.	Nom.	Max.	Min.	Nom.	Max.					Label	SEER	Pdesign	AEC
3MXS52E	1.5+1.5	1.50	1.50	---	---	1.88	3.00	4.72	0.35	0.61	1.30	1.5	2.7	5.7	99	4.92	A	305	A++	6.55	3.00	161
	1.5+2.0	1.50	2.00	---	---	1.88	3.50	4.72	0.35	0.77	1.30	1.5	3.4	5.7	99	4.55	A	385	A++	6.77	3.50	182
	1.5+2.5	1.50	2.50	---	---	1.88	4.00	5.68	0.35	0.95	1.91	1.5	4.2	8.4	99	4.21	A	475	A++	6.86	4.00	205
	1.5+3.5	1.50	3.50	---	---	1.88	5.00	5.99	0.35	1.45	2.17	1.5	6.4	9.5	99	3.45	A	725	A++	6.76	5.00	259
	1.5+4.2	1.37	3.83	---	---	1.88	5.20	6.08	0.35	1.55	2.25	1.5	6.8	9.9	99	3.35	A	775	A++	6.81	5.20	268
	1.5+5.0	1.20	---	4.00	---	1.88	5.20	6.29	0.35	1.46	2.27	1.5	6.4	10.0	99	3.56	A	730	A++	6.79	5.20	269
	2.0+2.0	2.00	2.00	---	---	1.88	4.00	5.96	0.35	0.95	1.91	1.5	4.2	8.4	99	4.21	A	475	A++	6.90	4.00	203
	2.0+2.5	2.00	2.50	---	---	1.88	4.50	6.23	0.35	1.18	2.14	1.5	5.2	9.4	99	3.81	A	590	A++	6.90	4.50	229
	2.0+3.5	1.89	3.31	---	---	1.88	5.20	6.24	0.35	1.55	2.07	1.5	6.8	9.1	99	3.35	A	775	A++	6.83	5.20	267
	2.0+4.2	1.68	3.52	---	---	1.88	5.20	6.25	0.35	1.55	2.07	1.5	6.8	9.1	99	3.35	A	775	A++	6.85	5.20	266
	2.0+5.0	1.49	---	3.71	---	1.88	5.20	6.47	0.35	1.42	2.15	1.5	6.2	9.4	99	3.66	A	710	A++	6.83	5.20	267
	2.5+2.5	2.50	2.50	---	---	1.88	5.00	6.23	0.35	1.45	2.14	1.5	6.4	9.4	99	3.45	A	725	A++	6.93	5.00	253
	2.5+3.5	2.17	3.03	---	---	1.88	5.20	6.35	0.35	1.55	2.25	1.5	6.8	9.9	99	3.35	A	775	A++	6.83	5.20	267
	2.5+4.2	1.94	3.26	---	---	1.88	5.20	6.36	0.35	1.55	2.25	1.5	6.8	9.9	99	3.35	A	775	A++	6.85	5.20	266
	2.5+5.0	1.73	---	3.47	---	1.88	5.20	6.47	0.35	1.42	2.07	1.5	6.2	9.1	99	3.66	A	710	A++	6.85	5.20	266
	3.5+3.5	2.60	2.60	---	---	1.88	5.20	6.40	0.35	1.55	2.25	1.5	6.8	9.9	99	3.35	A	775	A++	6.72	5.20	271
	3.5+4.2	2.36	2.84	---	---	1.88	5.20	6.41	0.35	1.55	2.25	1.5	6.8	9.9	99	3.35	A	775	A++	6.72	5.20	271
	3.5+5.0	2.14	---	3.06	---	1.88	5.21	6.49	0.35	1.42	2.09	1.5	6.2	9.2	99	3.67	A	710	A++	6.72	5.20	271
	4.2+4.2	2.60	2.60	---	---	1.88	5.20	6.42	0.35	1.55	2.25	1.5	6.8	9.9	99	3.35	A	775	A++	6.72	5.20	271
	15+15+15	1.50	1.50	1.50	---	1.86	4.50	6.71	0.35	0.97	2.16	1.5	4.3	9.5	99	4.64	A	485	A++	7.06	4.50	223
	15+15+20	1.50	1.50	2.00	---	1.86	5.00	6.71	0.35	1.18	2.16	1.5	5.2	9.5	99	4.24	A	590	A++	7.15	5.00	245
	15+15+25	1.42	1.42	2.36	---	1.86	5.20	6.71	0.35	1.24	2.16	1.5	5.4	9.5	99	4.19	A	620	A++	7.17	5.20	254
	15+15+35	1.20	1.20	2.80	---	1.95	5.20	6.72	0.35	1.24	2.16	1.5	5.4	9.5	99	4.19	A	620	A++	7.05	5.20	259
	15+15+42	1.08	1.08	3.03	---	1.95	5.20	6.73	0.35	1.24	2.16	1.5	5.4	9.5	99	4.19	A	620	A++	7.05	5.20	259
	15+15+50	0.98	0.98	3.25	---	2.11	5.20	6.90	0.35	1.21	2.17	1.5	5.3	9.5	99	4.30	A	605	A++	7.05	5.20	259
	15+20+20	1.42	1.89	1.89	---	1.86	5.20	6.71	0.35	1.24	2.16	1.5	5.4	9.5	99	4.19	A	620	A++	7.20	5.20	253
	15+20+25	1.30	1.73	2.17	---	1.86	5.20	6.71	0.35	1.24	2.16	1.5	5.4	9.5	99	4.19	A	620	A++	7.20	5.20	253
	15+20+35	1.11	1.49	2.60	---	1.95	5.20	6.72	0.35	1.24	2.16	1.5	5.4	9.5	99	4.19	A	620	A++	7.07	5.20	258
	15+20+42	1.01	1.35	2.84	---	1.95	5.20	6.73	0.35	1.24	2.16	1.5	5.4	9.5	99	4.19	A	620	A++	7.06	5.20	258
	15+20+50	0.92	1.22	3.06	---	2.11	5.20	6.90	0.35	1.21	2.17	1.5	5.3	9.5	99	4.30	A	605	A++	7.07	5.20	258
	15+25+25	1.20	2.00	2.00	---	1.86	5.20	6.71	0.35	1.24	2.16	1.5	5.4	9.5	99	4.19	A	620	A++	7.20	5.20	253
	15+25+35	1.04	1.73	2.43	---	1.95	5.20	6.72	0.35	1.24	2.16	1.5	5.4	9.5	99	4.19	A	620	A++	7.06	5.20	258
	15+25+42	0.95	1.59	2.66	---	1.95	5.20	6.73	0.35	1.24	2.16	1.5	5.4	9.5	99	4.19	A	620	A++	7.06	5.20	258
	15+25+50	0.87	1.44	2.89	---	2.11	5.20	6.90	0.35	1.21	2.17	1.5	5.3	9.5	99	4.30	A	605	A++	7.06	5.20	258
	15+35+35	0.92	2.14	2.14	---	1.86	5.20	6.73	0.35	1.24	2.16	1.5	5.4	9.5	99	4.19	A	620	A++	6.93	5.20	263
	20+20+20	1.73	1.73	1.73	---	1.86	5.19	7.04	0.35	1.24	2.16	1.5	5.4	9.5	99	4.19	A	620	A++	7.22	5.19	252
	20+20+25	1.60	1.60	1.99	---	1.86	5.19	7.04	0.35	1.24	2.16	1.5	5.4	9.5	99	4.19	A	620	A++	7.23	5.19	252
	20+20+35	1.38	1.38	2.43	---	1.95	5.19	7.06	0.37	1.24	2.16	1.6	5.4	9.5	99	4.19	A	620	A++	7.08	5.19	257
	20+20+42	1.27	1.27	2.66	---	1.95	5.20	7.07	0.37	1.24	2.16	1.6	5.4	9.5	99	4.19	A	620	A++	7.09	5.20	257
	20+20+50	1.16	1.16	2.88	---	2.11	5.20	7.30	0.38	1.22	2.26	1.7	5.4	9.9	99	4.26	A	610	A++	7.08	5.20	258
	20+25+25	1.49	1.85	1.85	---	1.86	5.19	7.04	0.35	1.24	2.16	1.5	5.4	9.5	99	4.19	A	620	A++	7.23	5.19	252
	20+25+35	1.30	1.63	2.27	---	1.95	5.20	7.06	0.37	1.24	2.16	1.6	5.4	9.5	99	4.19	A	620	A++	7.08	5.20	258
20+25+42	1.20	1.49	2.51	---	1.95	5.20	7.07	0.37	1.24	2.16	1.6	5.4	9.5	99	4.19	A	620	A++	7.09	5.20	257	
20+35+35	1.16	2.02	2.02	---	1.95	5.20	7.07	0.37	1.24	2.16	1.6	5.4	9.5	99	4.19	A	620	A++	6.94	5.20	263	
25+25+25	1.73	1.73	1.73	---	1.95	5.19	7.04	0.37	1.24	2.16	1.6	5.4	9.5	99	4.19	A	620	A++	7.23	5.19	252	
25+25+35	1.53	1.53	2.14	---	1.95	5.20	7.06	0.37	1.23	2.16	1.6	5.4	9.5	99	4.23	A	615	A++	7.09	5.20	257	

- Notes:
- Cooling capacity is based on 27°CDB/19°CWB (Indoor temperature), 35°CDB (Outdoor Temperature). Heating capacity is based on 20°CDB (Indoor temperature), 7°DB/6°CWB (Outdoor temperature).
 - The total ability of connected indoor unit is up to 9.0kW.
 - It is impossible to connect the indoor unit for one room only.
 - The above is the value for connecting with the following indoor units.
1.5kW: wall mounted CTXS-K series; 2.0, 2.5, 3.5, 4.2, 5.0kW: wall mounted FTXS-K series

Combination tables

Heating

Outdoor unit	Indoor unit	Heating capacity (kW)				Total capacity (kW)			Power input (kW)			Total current (A)			Power factor (%)	COP	Energy label	Seasonal data				
		A room	B room	C room	D room	Min.	Nom.	Max.	Min.	Nom.	Max.	Min.	Nom.	Max.				Label	SCOP	Pdesign	AEC	Back-up heater capacity at -10°C
3MXS52E	1.5+1.5	1.81	1.81	---	---	1.28	3.62	5.81	0.31	0.81	1.64	1.4	3.6	7.2	99	4.47	A	A+	4.09	3.59	1229	0.68
	1.5+2.0	1.74	2.33	---	---	1.28	4.07	5.81	0.31	0.94	1.64	1.4	4.1	7.2	99	4.33	A	A+	4.12	3.61	1227	0.68
	1.5+2.5	1.70	2.83	---	---	1.28	4.53	6.93	0.31	1.07	2.28	1.4	4.7	10.0	99	4.23	A	A+	4.04	4.73	1640	0.91
	1.5+3.5	1.63	3.79	---	---	1.28	5.42	6.96	0.31	1.37	2.28	1.4	6.0	10.0	99	3.96	A	A+	4.17	4.84	1624	0.93
	1.5+4.2	1.59	4.46	---	---	1.28	6.05	6.98	0.31	1.64	2.27	1.4	7.2	10.0	99	3.69	A	A+	4.18	4.85	1625	0.93
	1.5+5.0	1.56	---	5.21	---	1.27	6.77	7.20	0.31	1.83	2.32	1.4	8.0	10.2	99	3.70	A	A+	4.16	4.83	1626	0.93
	2.0+2.0	3.05	3.05	---	---	1.28	6.10	7.00	0.31	1.70	2.28	1.4	7.5	10.0	99	3.59	B	A+	4.05	4.75	1641	0.92
	2.0+2.5	2.78	3.47	---	---	1.28	6.25	7.00	0.31	1.75	2.28	1.4	7.7	10.0	99	3.57	B	A+	4.07	4.76	1636	0.92
	2.0+3.5	2.38	4.17	---	---	1.34	6.55	7.04	0.31	1.86	2.28	1.4	8.2	10.0	99	3.52	B	A+	4.23	4.86	1609	0.93
	2.0+4.2	2.16	4.54	---	---	1.34	6.70	7.05	0.31	1.93	2.27	1.4	8.5	10.0	99	3.47	B	A+	4.24	4.87	1610	0.94
	2.0+5.0	1.94	---	4.86	---	1.39	6.80	7.20	0.31	1.87	2.32	1.4	8.2	10.2	99	3.64	A	A+	4.18	4.85	1625	0.93
	2.5+2.5	3.25	3.25	---	---	1.28	6.50	7.00	0.31	1.86	2.31	1.4	8.2	10.1	99	3.49	B	A+	4.08	4.77	1636	0.92
	2.5+3.5	2.79	3.91	---	---	1.34	6.70	7.19	0.31	1.93	2.36	1.4	8.5	10.4	99	3.47	B	A+	4.24	4.87	1610	0.93
	2.5+4.2	2.54	4.26	---	---	1.34	6.80	7.21	0.31	1.93	2.35	1.4	8.5	10.3	99	3.52	B	A+	4.25	4.88	1608	0.94
	2.5+5.0	2.27	---	4.53	---	1.45	6.80	7.35	0.31	1.87	2.32	1.4	8.2	10.2	99	3.64	A	A+	4.23	4.86	1609	0.93
	3.5+3.5	3.40	3.40	---	---	1.40	6.80	7.22	0.31	1.97	2.35	1.4	8.7	10.3	99	3.45	B	A+	4.37	4.93	1580	0.94
	3.5+4.2	3.09	3.71	---	---	1.40	6.80	7.24	0.31	1.97	2.35	1.4	8.7	10.3	99	3.45	B	A+	4.37	4.93	1579	0.94
	3.5+5.0	2.80	---	4.00	---	1.45	6.80	7.50	0.31	1.83	2.31	1.4	8.0	10.1	99	3.72	A	A+	4.36	4.92	1581	0.94
	4.2+4.2	3.40	3.40	---	---	1.40	6.80	7.26	0.31	1.96	2.34	1.4	8.6	10.3	99	3.47	B	A+	4.42	4.94	1566	0.95
	15+15+15	1.66	1.66	1.66	---	1.34	4.97	8.02	0.32	1.02	2.14	1.4	4.5	9.4	99	4.87	A	A+	4.29	4.93	1609	0.94
	15+15+20	1.63	1.63	2.17	---	1.34	5.42	8.02	0.32	1.12	2.14	1.4	4.9	9.4	99	4.84	A	A+	4.31	4.94	1605	0.95
	15+15+25	1.60	1.60	2.67	---	1.34	5.87	8.02	0.32	1.26	2.14	1.4	5.5	9.4	99	4.66	A	A+	4.31	4.94	1603	0.94
	15+15+35	1.56	1.56	3.65	---	1.45	6.77	8.05	0.32	1.56	2.14	1.4	6.9	9.4	99	4.34	A	A+	4.39	4.95	1578	0.94
	15+15+42	1.42	1.42	3.97	---	1.45	6.80	8.06	0.32	1.56	2.14	1.4	6.9	9.4	99	4.36	A	A+	4.40	4.95	1576	0.95
	15+15+50	1.28	1.28	4.25	---	1.67	6.80	8.27	0.32	1.64	2.11	1.4	7.2	9.3	99	4.15	A	A+	4.39	4.95	1580	0.94
	15+20+20	1.60	2.13	2.13	---	1.34	5.87	8.02	0.32	1.26	2.14	1.4	5.5	9.4	99	4.66	A	A+	4.32	4.94	1602	0.94
	15+20+25	1.58	2.11	2.63	---	1.34	6.32	8.02	0.32	1.41	2.14	1.4	6.2	9.4	99	4.48	A	A+	4.36	4.94	1588	0.94
	15+20+35	1.46	1.94	3.40	---	1.45	6.80	8.05	0.32	1.56	2.14	1.4	6.9	9.4	99	4.36	A	A+	4.40	4.95	1575	0.95
	15+20+42	1.32	1.77	3.71	---	1.45	6.80	8.06	0.32	1.56	2.14	1.4	6.9	9.4	99	4.36	A	A+	4.43	4.94	1563	0.94
	15+20+50	1.20	1.60	4.00	---	1.67	6.80	8.27	0.32	1.64	2.11	1.4	7.2	9.3	99	4.15	A	A+	4.40	4.95	1576	0.95
	15+25+25	1.56	2.60	2.60	---	1.34	6.77	8.02	0.32	1.57	2.14	1.4	6.9	9.4	99	4.31	A	A+	4.34	4.95	1596	0.95
	15+25+35	1.36	2.27	3.17	---	1.45	6.80	8.05	0.32	1.56	2.14	1.4	6.9	9.4	99	4.36	A	A+	4.43	4.94	1563	0.94
	15+25+42	1.24	2.07	3.48	---	1.45	6.80	8.06	0.32	1.56	2.14	1.4	6.9	9.4	99	4.36	A	A+	4.42	4.94	1564	0.94
	15+25+50	1.13	1.89	3.78	---	1.67	6.80	8.27	0.32	1.64	2.11	1.4	7.2	9.3	99	4.15	A	A+	4.40	4.95	1575	0.95
	15+35+35	1.20	2.80	2.80	---	1.34	6.80	8.08	0.32	1.56	2.14	1.4	6.9	9.4	99	4.36	A	A+	4.47	4.90	1537	0.93
	20+20+20	2.26	2.26	2.26	---	1.34	6.78	8.02	0.32	1.57	2.14	1.4	6.9	9.4	99	4.32	A	A+	4.34	4.95	1596	0.95
	20+20+25	2.09	2.09	2.60	---	1.34	6.78	8.02	0.32	1.57	2.14	1.4	6.9	9.4	99	4.32	A	A+	4.35	4.95	1594	0.95
	20+20+35	1.80	1.80	3.18	---	1.45	6.78	8.05	0.32	1.56	2.14	1.4	6.9	9.4	99	4.35	A	A+	4.43	4.94	1562	0.94
	20+20+42	1.66	1.66	3.48	---	1.45	6.80	8.06	0.32	1.56	2.14	1.4	6.9	9.4	99	4.36	A	A+	4.44	4.94	1558	0.94
	20+20+50	1.51	1.51	3.78	---	1.67	6.80	8.27	0.32	1.64	2.11	1.4	7.2	9.3	99	4.15	A	A+	4.43	4.94	1563	0.94
	20+25+25	1.94	2.42	2.42	---	1.34	6.78	8.02	0.32	1.57	2.14	1.4	6.9	9.4	99	4.32	A	A+	4.36	4.95	1590	0.94
	20+25+35	1.70	2.13	2.98	---	1.57	6.80	8.05	0.32	1.56	2.14	1.4	6.9	9.4	99	4.36	A	A+	4.44	4.94	1557	0.94
	20+25+42	1.56	1.95	3.28	---	1.56	6.80	8.06	0.32	1.56	2.14	1.4	6.9	9.4	99	4.36	A	A+	4.44	4.94	1559	0.95
	20+35+35	1.52	2.64	2.64	---	1.56	6.80	8.08	0.32	1.56	2.14	1.4	6.9	9.4	99	4.36	A	A+	4.49	4.89	1525	0.94
	25+25+25	2.26	2.26	2.26	---	1.45	6.78	8.02	0.32	1.57	2.14	1.4	6.9	9.4	99	4.32	A	A+	4.40	4.95	1574	0.94
25+25+35	2.00	2.00	2.80	---	1.57	6.80	8.05	0.32	1.56	2.14	1.4	6.9	9.4	99	4.36	A	A+	4.46	4.93	1549	0.94	

- Notes:
1. Cooling capacity is based on 27°CDB/19°CWB (Indoor temperature), 35°CDB (Outdoor Temperature). Heating capacity is based on 20°CDB (Indoor temperature), 7°DB/6°CWB (Outdoor temperature).
 2. The total ability of connected indoor unit is up to 9.0kW.
 3. It is impossible to connect the indoor unit for one room only.
 4. The above is the value for connecting with the following indoor units.
1.5kW: wall mounted CTXS-K series; 2.0, 2.5, 3.5, 4.2, 5.0kW: wall mounted FTXS-K series

Combination tables

Cooling

Outdoor unit	Indoor unit	Cooling capacity (kW)				Total capacity (kW)			Power input (kW)			Total current (A)			Power factor (%)	EER	Energy label	AEC (kWh)	Seasonal data			
		A room	B room	C room	D room	Min.	Nom.	Max.	Min.	Nom.	Max.	Min.	Nom.	Max.					Label	SEER	Pdesign	AEC
3MXS68G	1.5+1.5	1.50	1.50	---	---	1.97	3.00	4.70	0.43	0.65	1.29	1.9	2.9	5.7	99	4.62	A	325	B	4.98	3.00	211
	1.5+2.0	1.50	2.00	---	---	1.97	3.50	4.86	0.43	0.80	1.37	1.9	3.5	6.0	99	4.38	A	400	B	5.09	3.50	241
	1.5+2.5	1.50	2.50	---	---	1.97	4.00	6.04	0.43	0.99	2.04	1.9	4.3	9.0	99	4.04	A	495	A	5.16	4.00	272
	1.5+3.5	1.50	3.50	---	---	1.97	5.00	6.25	0.42	1.39	2.20	1.8	6.1	9.7	99	3.60	A	695	A	5.14	5.00	341
	1.5+4.2	1.50	4.20	---	---	1.97	5.70	6.26	0.42	1.79	2.20	1.8	7.9	9.7	99	3.18	B	895	A	5.16	5.70	387
	1.5+5.0	1.50	5.00	---	---	1.97	6.50	7.06	0.41	2.22	2.60	1.8	9.7	11.4	99	2.93	C	1110	B	4.94	6.50	461
	1.5+6.0	1.36	5.44	---	---	1.98	6.80	7.38	0.40	2.26	2.60	1.8	9.9	11.4	99	3.01	B	1130	A	5.43	6.80	439
	2.0+2.0	2.00	2.00	---	---	1.97	4.00	5.02	0.43	1.00	1.45	1.9	4.4	6.4	99	4.00	A	500	A	5.18	4.00	271
	2.0+2.5	2.00	2.50	---	---	1.97	4.50	5.33	0.43	1.20	1.61	1.9	5.3	7.1	99	3.75	A	600	A	5.22	4.50	302
	2.0+3.5	2.00	3.50	---	---	1.97	5.50	6.18	0.42	1.66	2.15	1.8	7.3	9.4	99	3.31	A	830	A	5.23	5.50	368
	2.0+4.2	2.00	4.20	---	---	1.97	6.20	6.38	0.42	2.09	2.30	1.8	9.2	10.1	99	2.97	C	1045	B	5.08	6.20	428
	2.0+5.0	1.94	4.86	---	---	1.97	6.80	7.12	0.41	2.41	2.65	1.8	10.6	11.6	99	2.82	C	1205	B	4.93	6.80	483
	2.0+6.0	1.70	5.10	---	---	1.98	6.80	7.56	0.40	2.21	2.75	1.8	9.7	12.1	99	3.08	B	1105	A	5.49	6.80	434
	2.5+2.5	2.50	2.50	---	---	1.97	5.00	5.98	0.45	1.46	2.00	2.0	6.4	8.8	99	3.42	A	730	A	5.26	5.00	333
	2.5+3.5	2.50	3.50	---	---	1.97	6.00	6.44	0.43	2.06	2.37	1.9	9.0	10.4	99	2.91	C	1030	A	5.12	6.00	411
	2.5+4.2	2.50	4.20	---	---	1.97	6.70	6.81	0.43	2.54	2.67	1.9	11.2	11.7	99	2.64	D	1270	B	4.96	6.70	473
	2.5+5.0	2.27	4.53	---	---	1.97	6.80	7.23	0.40	2.41	2.75	1.8	10.6	12.1	99	2.82	C	1205	B	4.93	6.80	483
	2.5+6.0	2.00	4.80	---	---	1.98	6.80	7.56	0.38	2.21	2.75	1.7	9.7	12.1	99	3.08	B	1105	A	5.49	6.80	434
	3.5+3.5	3.40	3.40	---	---	1.97	6.80	6.99	0.41	2.51	2.66	1.8	11.0	11.7	99	2.71	D	1255	B	4.91	6.80	485
	3.5+4.2	3.09	3.71	---	---	1.97	6.80	7.10	0.41	2.51	2.76	1.8	11.0	12.1	99	2.71	D	1255	B	4.95	6.80	481
	3.5+5.0	2.80	4.00	---	---	1.97	6.80	7.61	0.38	2.41	3.12	1.7	10.6	13.7	99	2.82	C	1205	B	4.91	6.80	485
	3.5+6.0	2.51	4.29	---	---	2.28	6.80	7.91	0.43	2.21	3.06	1.9	9.7	13.4	99	3.08	B	1105	A	5.45	6.80	437
	4.2+4.2	3.40	3.40	---	---	1.97	6.80	7.00	0.41	2.51	2.66	1.8	11.0	11.7	99	2.71	D	1255	B	4.96	6.80	480
	4.2+5.0	3.10	3.70	---	---	1.97	6.80	7.62	0.38	2.41	3.12	1.7	10.6	13.7	99	2.82	C	1205	B	4.96	6.80	481
	4.2+6.0	2.80	4.00	---	---	2.28	6.80	7.92	0.43	2.21	3.06	1.9	9.7	13.4	99	3.08	B	1105	A	5.46	6.80	436
	5.0+5.0	3.40	3.40	---	---	2.36	6.80	8.06	0.47	2.31	3.35	2.1	10.1	14.7	99	2.94	C	1155	B	4.92	6.80	485
	5.0+6.0	3.09	3.71	---	---	2.49	6.80	8.28	0.48	2.12	3.28	2.1	9.3	14.4	99	3.21	A	1060	A	5.45	6.80	437
	15+15+15	1.50	1.50	1.50	---	1.98	4.50	6.11	0.42	1.03	1.68	1.8	4.5	7.4	99	4.37	A	515	A	5.27	4.50	300
	15+15+20	1.50	1.50	2.00	---	1.98	5.00	6.19	0.42	1.21	1.72	1.8	5.3	7.6	99	4.13	A	605	A	5.37	5.00	327
	15+15+25	1.50	1.50	2.50	---	1.98	5.50	6.74	0.42	1.44	2.03	1.8	6.3	8.9	99	3.82	A	720	A	5.42	5.50	355
	15+15+35	1.50	1.50	3.50	---	1.98	6.50	7.11	0.41	1.94	2.26	1.8	8.5	9.9	99	3.35	A	970	A	5.33	6.50	427
	15+15+42	1.42	1.42	3.97	---	1.98	6.80	7.32	0.41	2.12	2.40	1.8	9.3	10.5	99	3.21	A	1060	A	5.31	6.80	449
	15+15+50	1.28	1.28	4.25	---	1.98	6.80	7.72	0.39	2.02	2.59	1.7	8.9	11.4	99	3.37	A	1010	A	5.30	6.80	450
	15+15+60	1.13	1.13	4.53	---	2.33	6.80	8.04	0.44	1.88	2.59	1.9	8.3	11.4	99	3.62	A	940	A+	5.75	6.80	415
	15+20+20	1.50	2.00	2.00	---	1.98	5.50	6.35	0.42	1.44	1.81	1.8	6.3	7.9	99	3.82	A	720	A	5.46	5.50	353
	15+20+25	1.50	2.00	2.50	---	1.98	6.00	6.74	0.42	1.68	2.03	1.8	7.4	8.9	99	3.57	A	840	A	5.51	6.00	382
	15+20+35	1.46	1.94	3.40	---	1.98	6.80	7.11	0.41	2.12	2.26	1.8	9.3	9.9	99	3.21	A	1060	A	5.34	6.80	446
	15+20+42	1.32	1.77	3.71	---	1.98	6.80	7.32	0.41	2.12	2.40	1.8	9.3	10.5	99	3.21	A	1060	A	5.38	6.80	443
	15+20+50	1.20	1.60	4.00	---	1.98	6.80	7.72	0.39	2.02	2.59	1.7	8.9	11.4	99	3.37	A	1010	A	5.35	6.80	446
	15+20+60	1.07	1.43	4.29	---	2.33	6.80	8.04	0.44	1.88	2.59	1.9	8.3	11.4	99	3.62	A	940	A+	5.81	6.80	410
	15+25+25	1.50	2.50	2.50	---	1.98	6.50	6.96	0.41	1.94	2.16	1.8	8.5	9.5	99	3.35	A	970	A	5.45	6.50	418
	15+25+35	1.36	2.27	3.17	---	1.98	6.80	7.45	0.39	2.12	2.50	1.7	9.3	11.0	99	3.21	A	1060	A	5.38	6.80	443
	15+25+42	1.24	2.07	3.48	---	1.98	6.80	7.66	0.39	2.12	2.64	1.7	9.3	11.6	99	3.21	A	1060	A	5.38	6.80	443
	15+25+50	1.13	1.89	3.78	---	1.98	6.80	7.79	0.39	2.02	2.64	1.7	8.9	11.6	99	3.37	A	1010	A	5.38	6.80	443
	15+25+60	1.02	1.70	4.08	---	2.33	6.80	8.25	0.45	1.88	2.74	2.0	8.3	12.0	99	3.62	A	940	A+	5.81	6.80	410
15+35+35	1.20	2.80	2.80	---	1.98	6.80	7.46	0.40	2.12	2.50	1.8	9.3	11.0	99	3.21	A	1060	A	5.32	6.80	448	
15+35+42	1.11	2.59	3.10	---	1.98	6.80	7.67	0.40	2.12	2.64	1.8	9.3	11.6	99	3.21	A	1060	A	5.33	6.80	447	
15+35+50	1.02	2.38	3.40	---	2.30	6.80	8.29	0.44	2.02	3.06	1.9	8.9	13.4	99	3.37	A	1010	A	5.33	6.80	447	
15+35+60	0.93	2.16	3.71	---	2.33	6.80	9.04	0.45	1.88	3.44	2.0	8.3	15.1	99	3.62	A	940	A+	5.75	6.80	414	
15+42+42	1.03	2.88	2.88	---	1.98	6.80	8.10	0.40	2.12	3.01	1.8	9.3	13.2	99	3.21	A	1060	A	5.35	6.80	446	
15+42+50	0.95	2.67	3.18	---	2.30	6.80	8.68	0.44	2.02	3.45	1.9	8.9	15.2	99	3.37	A	1010	A	5.33	6.80	447	
20+20+20	2.00	2.00	2.00	---	1.98	6.00	6.51	0.42	1.64	1.89	1.8	7.2	8.3	99	3.66	A	820	A	5.53	6.00	380	
20+20+25	2.00	2.00	2.50	---	1.98	6.50	6.89	0.42	1.89	2.12	1.8	8.3	9.3	99	3.44	A	945	A	5.49	6.50	415	
20+20+35	1.81	1.81	3.18	---	1.98	6.80	7.25	0.41	2.07	2.35	1.8	9.1	10.3	99	3.29	A	1035	A	5.41	6.80	440	
20+20+42	1.66	1.66	3.48	---	1.98	6.80	7.46	0.41	2.07	2.50	1.8	9.1	11.0	99	3.29	A	1035	A	5.42	6.80	440	
20+20+50	1.51	1.51	3.78	---	1.98	6.80	7.85	0.39	2.02	2.69	1.7	8.9	11.8	99	3.37	A	1010	A	5.41	6.80	440	
20+20+60	1.36	1.36	4.08	---	2.33	6.80	8.11	0.44	1.83	2.64	1.9	8.0	11.6	99	3.72	A	915	A+	5.86	6.80	406	
20+25+25	1.94	2.43	2.43	---	1.98	6.80	7.10	0.41	2.07	2.26	1.8	9.1	9.9	99	3.29	A	1035	A	5.46	6.80	437	
20+25+35	1.70	2.13	2.97	---	1.98	6.80	7.59	0.39	2.07	2.59	1.7	9.1	11.4	99	3.29	A	1035	A	5.42	6.80	440	
20+25+42	1.56	1.95	3.29	---	1.98	6.80	7.78	0.39	2.07	2.75	1.7	9.1	12.1	99	3.29	A	1035	A	5.42	6.80	439	
20+25+50	1.43	1.79	3.58	---	1.98	6.80	7.92	0.39	2.02	2.74	1.7	8.9	12.0	99	3.37	A	1010	A	5.42	6.80	440	
20+25+60	1.30	1.62	3.88	---	2.33	6.80	8.38	0.45	1.83	2.84	2.0	8.0	12.5	99	3.72	A	915	A+	5.87	6.80	406	
20+35+35	1.52	2.64	2.64	---	1.98	6.80	7.91	0.40	2.07	2.85	1.8	9.1	12.5	99	3.29	A	1035	A	5.36	6.80	444	
20+35+42	1.40	2.45	2.95	---	1.98	6.80	8.09	0.40	2.07	3.01	1.8	9.1	13.2	99</								

Combination tables

Heating

Outdoor unit	Indoor unit	Heating capacity (kW)				Total capacity (kW)			Power input (kW)			Total current (A)			Power factor (%)	COP	Energy label	Seasonal data				
		A room	B room	C room	D room	Min.	Nom.	Max.	Min.	Nom.	Max.	Min.	Nom.	Max.				Label	SCOP	Pdesign	AEC	Back-up heater capacity at -10°C
3MXS68G	1.5+1.5	2.90	2.90	---	---	1.62	5.80	7.10	0.38	1.57	1.99	1.7	6.9	8.7	99	3.69	A	A	3.83	3.67	1340	0.70
	1.5+2.0	2.64	3.51	---	---	1.62	6.15	7.10	0.38	1.72	1.99	1.7	7.6	8.7	99	3.58	B	A	3.82	3.77	1381	0.69
	1.5+2.5	2.44	4.06	---	---	1.62	6.50	7.64	0.38	1.89	2.24	1.7	8.3	9.8	99	3.44	B	A	3.83	3.82	1397	0.73
	1.5+3.5	2.16	5.04	---	---	1.76	7.20	8.17	0.39	2.25	2.55	1.7	9.9	11.2	99	3.20	D	A	3.85	4.24	1542	0.80
	1.5+4.2	2.02	5.67	---	---	1.76	7.69	8.51	0.39	2.51	2.79	1.7	11.0	12.3	99	3.06	D	A	3.82	4.28	1567	0.83
	1.5+5.0	1.90	6.35	---	---	2.14	8.25	9.98	0.48	2.63	3.16	2.1	11.6	13.9	99	3.14	D	A	3.85	4.20	1526	0.81
	1.5+6.0	1.72	6.88	---	---	2.41	8.60	10.17	0.51	2.51	2.90	2.2	11.0	12.7	99	3.43	B	A	3.89	4.68	1684	0.88
	2.0+2.0	3.25	3.25	---	---	1.62	6.50	7.64	0.38	1.87	2.25	1.7	8.2	9.9	99	3.48	B	A	3.83	3.88	1420	0.74
	2.0+2.5	3.04	3.81	---	---	1.62	6.85	7.81	0.38	2.05	2.33	1.7	9.0	10.2	99	3.34	C	A	3.83	3.93	1439	0.73
	2.0+3.5	2.71	4.74	---	---	1.76	7.45	8.34	0.39	2.34	2.64	1.7	10.3	11.6	99	3.18	D	A	3.83	4.34	1589	0.83
	2.0+4.2	2.58	5.42	---	---	1.76	8.00	8.68	0.39	2.64	2.89	1.7	11.6	12.7	99	3.03	D	A	3.82	4.38	1607	0.82
	2.0+5.0	2.46	6.14	---	---	2.14	8.60	10.15	0.48	2.80	3.26	2.1	12.3	14.3	99	3.07	D	A	3.83	4.30	1572	0.85
	2.0+6.0	2.15	6.45	---	---	2.41	8.60	10.34	0.51	2.43	2.98	2.2	10.7	13.1	99	3.54	B	A	3.91	4.77	1708	0.91
	2.5+2.5	3.60	3.60	---	---	1.62	7.20	8.16	0.38	2.24	2.56	1.7	9.8	11.2	99	3.21	C	A	3.84	3.98	1452	0.77
	2.5+3.5	3.29	4.61	---	---	1.85	7.90	8.68	0.40	2.58	2.89	1.8	11.3	12.7	99	3.06	D	A	3.82	4.39	1610	0.83
	2.5+4.2	3.10	5.20	---	---	1.85	8.30	8.93	0.40	2.80	3.07	1.8	12.3	13.5	99	2.96	D	A	3.85	4.42	1606	0.85
	2.5+5.0	2.87	5.73	---	---	2.23	8.60	10.27	0.49	2.80	3.36	2.2	12.3	14.8	99	3.07	D	A	3.83	4.34	1589	0.83
	2.5+6.0	2.53	6.07	---	---	2.50	8.60	10.46	0.53	2.43	3.01	2.3	10.7	13.2	99	3.54	B	A	3.90	4.81	1725	0.89
	3.5+3.5	4.30	4.30	---	---	2.13	8.60	9.02	0.45	2.93	3.11	2.0	12.9	13.7	99	2.94	D	A	3.90	4.77	1712	0.91
	3.5+4.2	3.91	4.69	---	---	2.13	8.60	9.11	0.45	2.92	3.16	2.0	12.8	13.9	99	2.95	D	A	3.91	4.80	1721	0.93
	3.5+5.0	3.54	5.06	---	---	2.51	8.60	10.48	0.54	2.79	3.40	2.4	12.3	14.9	99	3.08	D	A	3.90	4.73	1697	0.92
	3.5+6.0	3.17	5.43	---	---	2.69	8.60	10.59	0.55	2.42	3.00	2.4	10.6	13.2	99	3.55	B	A	3.99	5.17	1813	1.01
	4.2+4.2	4.30	4.30	---	---	2.13	8.60	9.19	0.45	2.92	3.20	2.0	12.8	14.1	99	2.95	D	A	3.90	4.84	1736	0.92
	4.2+5.0	3.93	4.67	---	---	2.51	8.60	10.49	0.54	2.79	3.47	2.4	12.3	15.2	99	3.08	D	A	3.90	4.76	1709	0.90
	4.2+6.0	3.54	5.06	---	---	2.69	8.60	10.60	0.54	2.42	3.03	2.4	10.6	13.3	99	3.55	B	A+	4.01	5.20	1814	1.00
	5.0+5.0	4.30	4.30	---	---	2.88	8.60	10.67	0.63	2.70	3.38	2.8	11.9	14.8	99	3.19	D	A	3.88	4.69	1692	0.89
	5.0+6.0	3.91	4.69	---	---	3.08	8.60	10.66	0.64	2.39	2.96	2.8	10.5	13.0	99	3.60	B	A	3.99	5.13	1800	0.98
	15+15+15	2.28	2.28	2.28	---	1.97	6.83	9.37	0.44	1.63	2.38	1.9	7.2	10.5	99	4.19	A	A	3.86	4.75	1725	0.89
	15+15+20	2.15	2.15	2.87	---	1.97	7.18	9.37	0.44	1.77	2.38	1.9	7.8	10.5	99	4.06	A	A	3.89	4.84	1742	0.92
	15+15+25	2.06	2.06	3.43	---	2.06	7.54	9.96	0.45	1.89	2.65	2.0	8.3	11.6	99	3.99	A	A	3.90	4.88	1751	0.95
	15+15+35	1.90	1.90	4.44	---	2.26	8.25	10.05	0.47	2.23	2.80	2.1	9.8	12.3	99	3.70	A	A	3.96	5.23	1849	0.98
	15+15+42	1.79	1.79	5.02	---	2.26	8.60	10.06	0.47	2.38	2.79	2.1	10.5	12.3	99	3.61	A	A	3.98	5.26	1851	1.00
	15+15+50	1.61	1.61	5.38	---	2.66	8.60	10.23	0.58	2.38	2.87	2.5	10.5	12.6	99	3.61	A	A	3.96	5.19	1834	0.99
	15+15+60	1.43	1.43	5.73	---	2.87	8.60	10.44	0.58	2.16	2.63	2.5	9.5	11.6	99	3.98	A	A+	4.09	5.59	1913	1.08
	15+20+20	2.06	2.74	2.74	---	1.97	7.54	10.04	0.44	1.91	2.70	1.9	8.4	11.9	99	3.95	A	A	3.90	4.93	1771	0.95
	15+20+25	1.97	2.63	3.29	---	2.06	7.89	10.04	0.45	2.03	2.69	2.0	8.9	11.8	99	3.89	A	A	3.93	4.97	1772	0.94
	15+20+35	1.84	2.46	4.30	---	2.26	8.60	10.05	0.47	2.38	2.80	2.1	10.5	12.3	99	3.61	A	A+	4.00	5.31	1868	1.00
	15+20+42	1.68	2.23	4.69	---	2.26	8.60	10.06	0.47	2.38	2.79	2.1	10.5	12.3	99	3.61	A	A	3.98	5.34	1877	1.03
	15+20+50	1.52	2.02	5.06	---	2.66	8.60	10.46	0.58	2.38	2.87	2.5	10.5	12.6	99	3.61	A	A	3.99	5.27	1850	1.01
	15+20+60	1.36	1.81	5.43	---	2.87	8.60	10.55	0.58	2.16	2.63	2.5	9.5	11.6	99	3.98	A	A+	4.10	5.66	1934	1.10
	15+25+25	1.90	3.17	3.17	---	2.16	8.25	10.15	0.48	2.21	2.69	2.1	9.7	11.8	99	3.73	A	A	3.94	5.01	1780	0.97
	15+25+35	1.72	2.87	4.01	---	2.35	8.60	10.17	0.50	2.38	2.79	2.2	10.5	12.3	99	3.61	A	A	3.99	5.35	1880	1.04
	15+25+42	1.57	2.62	4.40	---	2.36	8.60	10.17	0.50	2.38	2.79	2.2	10.5	12.3	99	3.61	A	A+	4.02	5.38	1876	1.02
	15+25+50	1.43	2.39	4.78	---	2.75	8.60	10.58	0.60	2.38	2.87	2.6	10.5	12.6	99	3.61	A	A	3.98	5.31	1868	1.00
	15+25+60	1.29	2.15	5.16	---	2.96	8.60	10.44	0.61	2.16	2.62	2.7	9.5	11.5	99	3.98	A	A+	4.10	5.69	1945	1.08
	15+35+35	1.52	3.54	3.54	---	2.64	8.60	10.18	0.58	2.38	2.79	2.5	10.5	12.3	99	3.61	A	A+	4.09	5.66	1937	1.10
	15+35+42	1.40	3.27	3.93	---	2.64	8.60	10.18	0.58	2.37	2.78	2.5	10.4	12.2	99	3.63	A	A+	4.08	5.69	1951	1.09
	15+35+50	1.29	3.01	4.30	---	2.94	8.60	10.59	0.66	2.37	2.86	2.9	10.4	12.6	99	3.63	A	A+	4.09	5.62	1926	1.06
	15+35+60	1.17	2.74	4.69	---	2.97	8.60	10.46	0.61	2.15	2.62	2.7	9.4	11.5	99	4.00	A	A+	4.17	5.82	1954	1.11
	15+42+42	1.30	3.65	3.65	---	2.64	8.60	10.19	0.58	2.37	2.78	2.5	10.4	12.2	99	3.63	A	A+	4.10	5.71	1952	1.10
15+42+50	1.21	3.38	4.02	---	2.85	8.60	10.48	0.63	2.37	2.86	2.8	10.4	12.6	99	3.63	A	A+	4.09	5.65	1935	1.09	
20+20+20	2.63	2.63	2.63	---	1.97	7.89	10.04	0.44	2.05	2.70	1.9	9.0	11.9	99	3.85	A	A	3.94	5.01	1780	0.97	
20+20+25	2.54	2.54	3.17	---	2.06	8.25	10.12	0.45	2.18	2.74	2.0	9.6	12.0	99	3.78	A	A	3.94	5.05	1794	0.96	
20+20+35	2.29	2.29	4.02	---	2.26	8.60	10.22	0.47	2.34	2.88	2.1	10.3	12.6	99	3.68	A	A+	4.02	5.39	1879	1.03	
20+20+42	2.10	2.10	4.40	---	2.26	8.60	10.22	0.47	2.34	2.88	2.1	10.3	12.6	99	3.68	A	A+	4.02	5.42	1888	1.05	
20+20+50	1.91	1.91	4.78	---	2.66	8.60	10.40	0.58	2.34	2.96	2.5	10.3	13.0	99	3.68	A	A	3.99	5.35	1880	1.04	
20+20+60	1.72	1.72	5.16	---	2.87	8.60	10.53	0.58	2.12	2.67	2.5	9.3	11.7	99	4.06	A	A+	4.09	5.73	1960	1.08	
20+25+25	2.46	3.07	3.07	---	2.16	8.60	10.13	0.46	2.35	2.84	2.0	10.3	12.5	99	3.66	A	A	3.94	5.09	1807	0.99	
20+25+35	2.15	2.69	3.76	---	2.35	8.60	10.22	0.49	2.34	2.88	2.2	10.3	12.6	99	3.68	A	A+	4.02	5.42	1888	1.05	
20+25+42	1.98	2.47	4.15	---	2.36	8.60	10.23	0.49	2.34	2.87	2.2	10.3	12.6	99	3.68	A	A+	4.02	5.45	1899	1.04	
20+25+50	1.81	2.26	4.53	---	2.75	8.60	10.63	0.60	2.32	2.99	2.6	10.2	13.1	99	3.71	A	A+	4.02	5.39	1879	1.03	
20+25+60	1.64	2.05	4.91	---	2.96	8.60	10.64	0.60	2.10	2.64	2.6	9.2	11.6	99	4.10	A	A+	4.13	5.76	1952	1.11	
20+35+35	1.92	3.34	3.34	---	2.64	8.60	10.35	0.55	2.31	2.93	2.4	10.1	12.9	99	3.72							

Combination tables

Cooling

Outdoor unit	Indoor unit	Cooling capacity (kW)				Total capacity (kW)			Power input (kW)			Total current (A)			Power factor (%)	EER	Energy label	AEC (kWh)	Seasonal data			
		A room	B room	C room	D room	Min.	Nom.	Max.	Min.	Nom.	Max.	Min.	Nom.	Max.					Label	SEER	Pdesign	AEC
4MXS68F	1.5+1.5	1.50	1.50	---	---	1.97	3.00	4.70	0.43	0.65	1.29	1.9	2.9	5.7	99	4.62	A	325	B	4.98	3.00	241
	1.5+2.0	1.50	2.00	---	---	1.97	3.50	4.86	0.43	0.80	1.37	1.9	3.5	6.0	99	4.38	A	400	B	5.09	3.50	241
	1.5+2.5	1.50	2.50	---	---	1.97	4.00	5.18	0.43	0.99	1.53	1.9	4.3	6.7	99	4.04	A	495	A	5.16	4.00	272
	1.5+3.5	1.50	3.50	---	---	1.97	5.00	6.05	0.42	1.39	2.06	1.8	6.1	9.0	99	3.60	A	695	A	5.14	5.00	341
	1.5+4.2	1.50	4.20	---	---	1.97	5.70	6.26	0.42	1.79	2.20	1.8	7.9	9.7	99	3.18	B	895	A	5.16	5.70	387
	1.5+5.0	1.50	5.00	---	---	1.97	6.50	6.94	0.41	2.22	2.51	1.8	9.7	11.0	99	2.93	C	1110	B	4.94	6.50	461
	1.5+6.0	1.36	5.44	---	---	1.98	6.80	7.44	0.40	2.26	2.65	1.8	9.9	11.6	99	3.01	B	1130	A	5.43	6.80	439
	2.0+2.0	2.00	2.00	---	---	1.97	4.00	5.02	0.43	1.00	1.45	1.9	4.4	6.4	99	4.00	A	500	A	5.18	4.00	271
	2.0+2.5	2.00	2.50	---	---	1.97	4.50	5.33	0.43	1.20	1.61	1.9	5.3	7.1	99	3.75	A	600	A	5.22	4.50	302
	2.0+3.5	2.00	3.50	---	---	1.97	5.50	6.18	0.42	1.66	2.15	1.8	7.3	9.4	99	3.31	A	830	A	5.23	5.50	368
	2.0+4.2	2.00	4.20	---	---	1.97	6.20	6.38	0.42	2.09	2.30	1.8	9.2	10.1	99	2.97	C	1045	B	5.08	6.20	428
	2.0+5.0	1.94	4.86	---	---	1.97	6.80	7.12	0.41	2.41	2.65	1.8	10.6	11.6	99	2.82	C	1205	B	4.93	6.80	483
	2.0+6.0	1.70	5.10	---	---	1.98	6.80	7.56	0.40	2.21	2.75	1.8	9.7	12.1	99	3.08	B	1105	A	5.49	6.80	434
	2.5+2.5	2.50	2.50	---	---	1.97	5.00	5.98	0.45	1.46	2.00	2.0	6.4	8.8	99	3.42	A	730	A	5.26	5.00	333
	2.5+3.5	2.50	3.50	---	---	1.97	6.00	6.44	0.43	2.06	2.37	1.9	9.0	10.4	99	2.91	C	1030	A	5.12	6.00	411
	2.5+4.2	2.50	4.20	---	---	1.97	6.70	6.81	0.43	2.54	2.67	1.9	11.2	11.7	99	2.64	D	1270	B	4.96	6.70	473
	2.5+5.0	2.27	4.53	---	---	1.97	6.80	7.23	0.40	2.41	2.75	1.8	10.6	12.1	99	2.82	C	1205	B	4.93	6.80	483
	2.5+6.0	2.00	4.80	---	---	1.98	6.80	7.56	0.38	2.21	2.75	1.7	9.7	12.1	99	3.08	B	1105	A	5.49	6.80	434
	3.5+3.5	3.40	3.40	---	---	1.97	6.80	6.99	0.41	2.51	2.66	1.8	11.0	11.7	99	2.71	D	1255	B	4.91	6.80	485
	3.5+4.2	3.09	3.71	---	---	1.97	6.80	7.10	0.41	2.51	2.76	1.8	11.0	12.1	99	2.71	D	1255	B	4.95	6.80	481
	3.5+5.0	2.80	4.00	---	---	1.97	6.80	7.61	0.38	2.41	3.12	1.7	10.6	13.7	99	2.82	C	1205	B	4.91	6.80	485
	3.5+6.0	2.51	4.29	---	---	2.28	6.80	7.91	0.43	2.21	3.06	1.9	9.7	13.4	99	3.08	B	1105	A	5.45	6.80	437
	4.2+4.2	3.40	3.40	---	---	1.97	6.80	7.00	0.41	2.51	2.66	1.8	11.0	11.7	99	2.71	D	1255	B	4.96	6.80	480
	4.2+5.0	3.10	3.70	---	---	1.97	6.80	7.62	0.38	2.41	3.12	1.7	10.6	13.7	99	2.82	C	1205	B	4.96	6.80	481
	4.2+6.0	2.80	4.00	---	---	2.28	6.80	7.92	0.43	2.21	3.06	1.9	9.7	13.4	99	3.08	B	1105	A	5.46	6.80	436
	5.0+5.0	3.40	3.40	---	---	2.36	6.80	8.06	0.47	2.31	3.35	2.1	10.1	14.7	99	2.94	C	1155	B	4.92	6.80	485
	5.0+6.0	3.09	3.71	---	---	2.49	6.80	8.28	0.48	2.12	3.28	2.1	9.3	14.4	99	3.21	A	1060	A	5.45	6.80	437
	15+15+15	1.50	1.50	1.50	---	1.98	4.50	6.27	0.42	1.03	1.76	1.8	4.5	7.7	99	4.37	A	515	A	5.27	4.50	300
	15+15+20	1.50	1.50	2.00	---	1.98	5.00	6.43	0.42	1.21	1.85	1.8	5.3	8.1	99	4.13	A	605	A	5.37	5.00	327
	15+15+25	1.50	1.50	2.50	---	1.98	5.50	6.59	0.42	1.44	1.94	1.8	6.3	8.5	99	3.82	A	720	A	5.42	5.50	355
	15+15+35	1.50	1.50	3.50	---	1.98	6.50	6.97	0.41	1.94	2.16	1.8	8.5	9.5	99	3.35	A	970	A	5.33	6.50	427
	15+15+42	1.42	1.42	3.97	---	1.98	6.80	7.19	0.41	2.12	2.30	1.8	9.3	10.1	99	3.21	A	1060	A	5.31	6.80	449
	15+15+50	1.28	1.28	4.25	---	1.98	6.80	7.59	0.39	2.02	2.49	1.7	8.9	10.9	99	3.37	A	1010	A	5.30	6.80	450
	15+15+60	1.13	1.13	4.53	---	2.33	6.80	7.83	0.44	1.88	2.44	1.9	8.3	10.7	99	3.62	A	940	A+	5.75	6.80	415
	15+20+20	1.50	2.00	2.00	---	1.98	5.50	6.35	0.42	1.44	1.81	1.8	6.3	7.9	99	3.82	A	720	A	5.46	5.50	353
	15+20+25	1.50	2.00	2.50	---	1.98	6.00	6.74	0.42	1.68	2.03	1.8	7.4	8.9	99	3.57	A	840	A	5.51	6.00	382
	15+20+35	1.46	1.94	3.40	---	1.98	6.80	7.11	0.41	2.12	2.26	1.8	9.3	9.9	99	3.21	A	1060	A	5.34	6.80	446
	15+20+42	1.32	1.77	3.71	---	1.98	6.80	7.32	0.41	2.12	2.40	1.8	9.3	10.5	99	3.21	A	1060	A	5.38	6.80	443
	15+20+50	1.20	1.60	4.00	---	1.98	6.80	7.72	0.39	2.02	2.59	1.7	8.9	11.4	99	3.37	A	1010	A	5.35	6.80	446
	15+20+60	1.07	1.43	4.29	---	2.33	6.80	7.97	0.44	1.88	2.54	1.9	8.3	11.2	99	3.62	A	940	A+	5.81	6.80	410
	15+25+25	1.50	2.50	2.50	---	1.98	6.50	6.96	0.41	1.94	2.16	1.8	8.5	9.5	99	3.35	A	970	A	5.45	6.50	418
	15+25+35	1.36	2.27	3.17	---	1.98	6.80	7.45	0.39	2.12	2.50	1.7	9.3	11.0	99	3.21	A	1060	A	5.38	6.80	443
	15+25+42	1.24	2.07	3.48	---	1.98	6.80	7.66	0.39	2.12	2.64	1.7	9.3	11.6	99	3.21	A	1060	A	5.38	6.80	443
	15+25+50	1.13	1.89	3.78	---	1.98	6.80	7.79	0.39	2.02	2.64	1.7	8.9	11.6	99	3.37	A	1010	A	5.38	6.80	443
	15+25+60	1.02	1.70	4.08	---	2.33	6.80	8.25	0.45	1.88	2.74	2.0	8.3	12.0	99	3.62	A	940	A+	5.81	6.80	410
	15+35+35	1.20	2.80	2.80	---	1.98	6.80	7.78	0.40	2.12	2.75	1.8	9.3	12.1	99	3.21	A	1060	A	5.32	6.80	448
	15+35+42	1.11	2.59	3.10	---	1.98	6.80	7.97	0.40	2.12	2.90	1.8	9.3	12.7	99	3.21	A	1060	A	5.33	6.80	447
	15+35+50	1.02	2.38	3.40	---	1.98	6.80	8.29	0.36	2.02	3.06	1.6	8.9	13.4	99	3.37	A	1010	A	5.33	6.80	447
	15+35+60	0.93	2.16	3.71	---	2.33	6.80	8.39	0.45	1.88	2.84	2.0	8.3	12.5	99	3.62	A	940	A+	5.75	6.80	414
	15+42+42	1.03	2.88	2.88	---	1.98	6.80	8.10	0.40	2.12	3.01	1.8	9.3	13.2	99	3.21	A	1060	A	5.35	6.80	446
	15+42+50	0.95	2.67	3.18	---	1.98	6.80	8.36	0.36	2.02	3.11	1.6	8.9	13.7	99	3.37	A	1010	A	5.33	6.80	447
	20+20+20	2.00	2.00	2.00	---	1.98	6.00	6.51	0.42	1.64	1.89	1.8	7.2	8.3	99	3.66	A	820	A	5.53	6.00	380
	20+20+25	2.00	2.00	2.50	---	1.98	6.50	6.89	0.42	1.89	2.12	1.8	8.3	9.3	99	3.44	A	945	A	5.49	6.50	415
	20+20+35	1.81	1.81	3.18	---	1.98	6.80	7.25	0.41	2.07	2.35	1.8	9.1	10.3	99	3.29	A	1035	A	5.41	6.80	440
	20+20+42	1.66	1.66	3.48	---	1.98	6.80	7.46	0.41	2.07	2.50	1.8	9.1	11.0	99	3.29	A	1035	A	5.42	6.80	440
	20+20+50	1.51	1.51	3.78	---	1.98	6.80	7.85	0.39	2.02	2.69	1.7	8.9	11.8	99	3.37	A	1010	A	5.41	6.80	440
	20+20+60	1.36	1.36	4.08	---	2.33	6.80	8.11	0.44	1.83	2.64	1.9	8.0	11.6	99	3.72	A	915	A+	5.86	6.80	406
	20+25+25	1.94	2.43	2.43	---	1.98	6.80	7.10	0.41	2.07	2.26	1.8	9.1	9.9	99	3.29	A	1035	A	5.46	6.80	437
	20+25+35	1.70	2.13	2.97	---	1.98	6.80	7.59	0.39	2.07	2.59	1.7	9.1	11.4	99	3.29	A	1035	A	5.42	6.80	440
	20+25+42	1.56	1.95	3.29	---	1.98	6.80	7.78	0.39	2.07	2.75	1.7	9.1	12.1	99	3.29	A	1035	A	5.42	6.80	439
20+25+50	1.43	1.79	3.58	---	1.98	6.80	7.92	0.39	2.02	2.74	1.7	8.9	12.0	99	3.37	A	1010	A	5.42	6.80	440	
20+25+60	1.30	1.62	3.88	---	2.33	6.80	8.38	0.45	1.83	2.84	2.0	8.0	12.5	99	3.72	A	915	A+	5.87	6.80	406	
20+35+35	1.52	2.64	2.64	---	1.98	6.80	7.91	0.40	2.07	2.85	1.8	9.1	12.5	99	3.29	A	1035	A	5.36	6.80	444	
20+35+42	1.40	2.45	2.94	---	1.98	6.80	8.09	0.40	2.07	3.01	1.8	9.1	13.2	99</								

Combination tables

Cooling

Outdoor unit	Indoor unit	Cooling capacity (kW)				Total capacity (kW)			Power input (kW)			Total current (A)			Power factor (%)	EER	Energy label	AEC (kWh)	Seasonal data			
		A room	B room	C room	D room	Min.	Nom.	Max.	Min.	Nom.	Max.	Min.	Nom.	Max.					Label	SEER	Pdesign	AEC
4MXS68F	15+15+20+20	1.46	1.46	1.94	1.94	1.99	6.80	7.30	0.41	1.75	2.00	1.8	7.7	8.8	99	3.89	A	875	A+	5.68	6.80	420
	15+15+20+25	1.36	1.36	1.81	2.27	1.99	6.80	7.47	0.39	1.73	2.10	1.7	7.6	9.2	99	3.93	A	865	A+	5.69	6.80	419
	15+15+20+35	1.20	1.20	1.60	2.80	1.99	6.80	7.87	0.40	1.71	2.33	1.8	7.5	10.2	99	3.98	A	855	A+	5.62	6.80	424
	15+15+20+42	1.11	1.11	1.48	3.10	1.99	6.80	8.03	0.40	1.71	2.43	1.8	7.5	10.7	99	3.98	A	855	A+	5.63	6.80	423
	15+15+20+50	1.02	1.02	1.36	3.40	2.47	6.80	8.46	0.46	1.71	2.71	2.0	7.5	11.9	99	3.98	A	855	A+	5.62	6.80	424
	15+15+20+60	0.93	0.93	1.24	3.71	2.50	6.80	8.39	0.43	1.57	2.45	1.9	6.9	10.8	99	4.33	A	785	A+	6.02	6.80	396
	15+15+25+25	1.28	1.28	2.13	2.13	1.99	6.80	7.55	0.39	1.73	2.14	1.7	7.6	9.4	99	3.93	A	865	A+	5.69	6.80	419
	15+15+25+35	1.13	1.13	1.89	2.64	2.34	6.80	7.95	0.50	1.71	2.38	2.2	7.5	10.5	99	3.98	A	855	A+	5.63	6.80	423
	15+15+25+42	1.05	1.05	1.75	2.94	2.34	6.80	8.11	0.50	1.71	2.48	2.2	7.5	10.9	99	3.98	A	855	A+	5.63	6.80	423
	15+15+25+50	0.97	0.97	1.62	3.24	2.47	6.80	8.53	0.46	1.71	2.76	2.0	7.5	12.1	99	3.98	A	855	A+	5.63	6.80	423
	15+15+25+55	1.02	1.02	2.38	2.38	2.34	6.80	8.40	0.50	1.71	2.68	2.2	7.5	11.8	99	3.98	A	855	A	5.58	6.80	427
	15+15+25+60	0.95	0.95	2.22	2.67	2.46	6.80	8.48	0.54	1.71	2.74	2.4	7.5	12.0	99	3.98	A	855	A	5.59	6.80	427
	15+20+20+20	1.36	1.81	1.81	1.81	1.99	6.80	7.46	0.41	1.75	2.10	1.8	7.7	9.2	99	3.89	A	875	A+	5.72	6.80	417
	15+20+20+25	1.28	1.70	1.70	2.13	1.99	6.80	7.63	0.39	1.73	2.19	1.7	7.6	9.6	99	3.93	A	865	A+	5.73	6.80	416
	15+20+20+35	1.13	1.51	1.51	2.64	2.34	6.80	8.02	0.50	1.71	2.43	2.2	7.5	10.7	99	3.98	A	855	A+	5.66	6.80	421
	15+20+20+42	1.05	1.40	1.40	2.94	2.34	6.80	8.18	0.50	1.71	2.53	2.2	7.5	11.1	99	3.98	A	855	A+	5.67	6.80	420
	15+20+20+50	0.97	1.30	1.30	3.24	2.47	6.80	8.60	0.46	1.71	2.82	2.0	7.5	12.4	99	3.98	A	855	A+	5.66	6.80	421
	15+20+25+25	1.20	1.60	2.00	2.00	1.99	6.80	7.71	0.39	1.73	2.24	1.7	7.6	9.8	99	3.93	A	865	A+	5.73	6.80	416
	15+20+25+35	1.07	1.43	1.79	2.51	2.34	6.80	8.10	0.50	1.71	2.48	2.2	7.5	10.9	99	3.98	A	855	A+	5.67	6.80	420
	15+20+25+42	1.00	1.33	1.67	2.80	2.34	6.80	8.26	0.50	1.71	2.58	2.2	7.5	11.3	99	3.98	A	855	A+	5.67	6.80	420
	15+20+25+50	0.93	1.24	1.55	3.09	2.47	6.80	8.68	0.46	1.71	2.87	2.0	7.5	12.6	99	3.98	A	855	A+	5.67	6.80	420
	15+20+35+35	0.97	1.30	2.27	2.27	2.00	6.80	8.47	0.40	1.71	2.74	1.8	7.5	12.0	99	3.98	A	855	A+	5.60	6.80	425
	15+25+25+25	1.13	1.89	1.89	1.89	1.99	6.80	8.02	0.36	1.71	2.43	1.6	7.5	10.7	99	3.98	A	855	A+	5.73	6.80	416
	15+25+25+35	1.02	1.70	1.70	2.38	2.34	6.80	8.32	0.43	1.70	2.63	1.9	7.5	11.6	99	4.00	A	850	A+	5.67	6.80	420
	15+25+25+42	0.95	1.59	1.59	2.67	2.34	6.80	8.33	0.45	1.73	2.63	2.0	7.6	11.6	99	3.93	A	865	A+	5.67	6.80	420
	15+25+35+35	0.93	1.55	2.16	2.16	2.34	6.80	8.54	0.43	1.70	2.79	1.9	7.5	12.3	99	4.00	A	850	A+	5.62	6.80	424
	20+20+20+20	1.70	1.70	1.70	1.70	1.99	6.80	7.63	0.41	1.75	2.19	1.8	7.7	9.6	99	3.89	A	875	A+	5.75	6.80	415
	20+20+20+25	1.60	1.60	1.60	2.00	1.99	6.80	7.79	0.39	1.73	2.29	1.7	7.6	10.1	99	3.93	A	865	A+	5.75	6.80	414
	20+20+20+35	1.43	1.43	1.43	2.51	1.99	6.80	8.17	0.40	1.71	2.53	1.8	7.5	11.1	99	3.98	A	855	A+	5.70	6.80	418
	20+20+20+42	1.33	1.33	1.33	2.81	1.99	6.80	8.32	0.40	1.71	2.63	1.8	7.5	11.6	99	3.98	A	855	A+	5.73	6.80	416
	20+20+20+50	1.24	1.24	1.24	3.08	2.47	6.80	8.74	0.46	1.67	2.93	2.0	7.3	12.9	99	4.07	A	835	A+	5.70	6.80	418
	20+20+25+25	1.51	1.51	1.89	1.89	1.99	6.80	7.94	0.40	1.75	2.38	1.8	7.7	10.5	99	3.89	A	875	A+	5.77	6.80	413
	20+20+25+35	1.36	1.36	1.70	2.38	2.34	6.80	8.32	0.45	1.73	2.63	2.0	7.6	11.6	99	3.93	A	865	A+	5.71	6.80	418
	20+20+25+42	1.27	1.27	1.59	2.67	2.34	6.80	8.47	0.45	1.73	2.74	2.0	7.6	12.0	99	3.93	A	865	A+	5.73	6.80	416
	20+20+35+35	1.24	1.24	2.16	2.16	2.46	6.80	8.61	0.45	1.71	2.84	2.0	7.5	12.5	99	3.98	A	855	A+	5.66	6.80	421
	20+25+25+25	1.43	1.79	1.79	1.79	1.99	6.80	8.17	0.40	1.75	2.53	1.8	7.7	11.1	99	3.89	A	875	A+	5.77	6.80	413
	20+25+25+35	1.30	1.62	1.62	2.26	2.34	6.80	8.46	0.45	1.73	2.74	2.0	7.6	12.0	99	3.93	A	865	A+	5.73	6.80	416
	25+25+25+25	1.70	1.70	1.70	1.70	2.34	6.80	8.39	0.46	1.71	2.68	2.0	7.5	11.8	99	3.98	A	855	A+	5.77	6.80	413
	25+25+25+35	1.55	1.55	1.55	2.15	2.46	6.80	8.73	0.46	1.70	2.95	2.0	7.5	13.0	99	4.00	A	850	A+	5.73	6.80	416

- Notes:
- Cooling capacity is based on 27°CDB/19°CWB (Indoor temperature), 35°CDB (Outdoor temperature). Heating capacity is based on 20°CDB (Indoor temperature), 7°CDB/6°CWB (Outdoor temperature).
 - The total ability of connected indoor unit is up to 11.0kW.
 - It is impossible to connect the indoor unit for one room only.
 - The above is the value for connecting with the following indoor units.
1.5kW: wall mounted CTXS-K series; 2.0, 2.5, 3.5, 4.2, 5.0kW: wall mounted FTXS-K series
6.0 kW class; wall mounted G series

Combination tables

Heating

Outdoor unit	Indoor unit	Heating capacity (kW)				Total capacity (kW)			Power input (kW)			Total current (A)			Power factor (%)	COP	Energy label	Seasonal data				
		A room	B room	C room	D room	Min.	Nom.	Max.	Min.	Nom.	Max.	Min.	Nom.	Max.				Label	SCOP	Pdesign	AEC	Back-up heater capacity at -10°C
4MXS68F	1.5+1.5	2.62	2.62	---	---	1.62	5.24	7.10	0.38	1.32	1.99	1.7	5.8	8.7	99	3.97	A	A	3.83	3.67	1340	0.70
	1.5+2.0	2.43	3.23	---	---	1.62	5.66	7.46	0.38	1.50	2.16	1.7	6.6	9.5	99	3.77	A	A	3.82	3.77	1381	0.69
	1.5+2.5	2.28	3.80	---	---	1.62	6.08	7.64	0.38	1.70	2.24	1.7	7.5	9.8	99	3.58	B	A	3.83	3.82	1397	0.73
	1.5+3.5	2.08	4.84	---	---	1.76	6.92	8.17	0.39	2.09	2.55	1.7	9.2	11.2	99	3.31	C	A	3.85	4.24	1542	0.80
	1.5+4.2	1.98	5.53	---	---	1.76	7.51	8.51	0.39	2.38	2.79	1.7	10.5	12.3	99	3.16	D	A	3.82	4.28	1567	0.83
	1.5+5.0	1.89	6.29	---	---	2.14	8.18	9.98	0.48	2.58	3.16	2.1	11.3	13.9	99	3.17	D	A	3.85	4.20	1526	0.81
	1.5+6.0	1.72	6.88	---	---	2.41	8.60	10.17	0.51	2.51	2.90	2.2	11.0	12.7	99	3.43	B	A	3.89	4.68	1684	0.88
	2.0+2.0	3.25	3.25	---	---	1.62	6.50	7.64	0.38	1.87	2.25	1.7	8.2	9.9	99	3.48	B	A	3.83	3.88	1420	0.74
	2.0+2.5	3.04	3.81	---	---	1.62	6.85	7.81	0.38	2.05	2.33	1.7	9.0	10.2	99	3.34	C	A	3.83	3.93	1439	0.73
	2.0+3.5	2.71	4.74	---	---	1.76	7.45	8.34	0.39	2.34	2.64	1.7	10.3	11.6	99	3.18	D	A	3.83	4.34	1589	0.83
	2.0+4.2	2.58	5.42	---	---	1.76	8.00	8.68	0.39	2.64	2.89	1.7	11.6	12.7	99	3.03	D	A	3.82	4.38	1607	0.82
	2.0+5.0	2.46	6.14	---	---	2.14	8.60	10.15	0.48	2.80	3.26	2.1	12.3	14.3	99	3.07	D	A	3.83	4.30	1572	0.85
	2.0+6.0	2.15	6.45	---	---	2.41	8.60	10.34	0.51	2.43	2.98	2.2	10.7	13.1	99	3.54	B	A	3.91	4.77	1708	0.91
	2.5+2.5	3.60	3.60	---	---	1.62	7.20	8.16	0.38	2.24	2.56	1.7	9.8	11.2	99	3.21	C	A	3.84	3.98	1452	0.77
	2.5+3.5	3.29	4.61	---	---	1.85	7.90	8.68	0.40	2.58	2.89	1.8	11.3	12.7	99	3.06	D	A	3.82	4.39	1610	0.83
	2.5+4.2	3.10	5.20	---	---	1.85	8.30	8.93	0.40	2.80	3.07	1.8	12.3	13.5	99	2.96	D	A	3.85	4.42	1606	0.85
	2.5+5.0	2.87	5.73	---	---	2.23	8.60	10.27	0.49	2.80	3.36	2.2	12.3	14.8	99	3.07	D	A	3.83	4.34	1589	0.83
	2.5+6.0	2.53	6.07	---	---	2.50	8.60	10.46	0.53	2.43	3.01	2.3	10.7	13.2	99	3.54	B	A	3.90	4.81	1725	0.89
	3.5+3.5	4.30	4.30	---	---	2.13	8.60	9.02	0.45	2.93	3.11	2.0	12.9	13.7	99	2.94	D	A	3.90	4.77	1712	0.91
	3.5+4.2	3.91	4.69	---	---	2.13	8.60	9.11	0.45	2.92	3.16	2.0	12.8	13.9	99	2.95	D	A	3.91	4.80	1721	0.93
	3.5+5.0	3.54	5.06	---	---	2.51	8.60	10.48	0.54	2.79	3.40	2.4	12.3	14.9	99	3.08	D	A	3.90	4.73	1697	0.92
	3.5+6.0	3.17	5.43	---	---	2.69	8.60	10.59	0.55	2.42	3.00	2.4	10.6	13.2	99	3.55	B	A	3.99	5.17	1813	1.01
	4.2+4.2	4.30	4.30	---	---	2.13	8.60	9.19	0.45	2.92	3.20	2.0	12.8	14.1	99	2.95	D	A	3.90	4.84	1736	0.92
	4.2+5.0	3.93	4.67	---	---	2.51	8.60	10.49	0.54	2.79	3.47	2.4	12.3	15.2	99	3.08	D	A	3.90	4.76	1709	0.90
	4.2+6.0	3.54	5.06	---	---	2.69	8.60	10.60	0.54	2.42	3.03	2.4	10.6	13.3	99	3.55	B	A+	4.01	5.20	1814	1.00
	5.0+5.0	4.30	4.30	---	---	2.88	8.60	10.67	0.63	2.70	3.38	2.8	11.9	14.8	99	3.19	D	A	3.88	4.69	1692	0.89
	5.0+6.0	3.91	4.69	---	---	3.08	8.60	10.66	0.64	2.39	2.96	2.8	10.5	13.0	99	3.60	B	A	3.99	5.13	1800	0.98
	15+15+15	2.17	2.17	2.17	---	1.97	6.50	9.54	0.44	1.50	2.46	1.9	6.6	10.8	99	4.33	A	A	3.86	4.75	1725	0.89
	15+15+20	2.08	2.08	2.77	---	1.97	6.92	9.71	0.44	1.67	2.54	1.9	7.3	11.2	99	4.14	A	A	3.89	4.84	1742	0.92
	15+15+25	2.00	2.00	3.34	---	2.06	7.34	9.79	0.45	1.82	2.58	2.0	8.0	11.3	99	4.03	A	A	3.90	4.88	1751	0.95
	15+15+35	1.89	1.89	4.40	---	2.26	8.18	9.89	0.47	2.19	2.71	2.1	9.6	11.9	99	3.74	A	A	3.96	5.23	1849	0.98
	15+15+42	1.79	1.79	5.02	---	2.26	8.60	9.89	0.47	2.38	2.71	2.1	10.5	11.9	99	3.61	A	A	3.98	5.26	1851	1.00
	15+15+50	1.61	1.61	5.38	---	2.66	8.60	10.06	0.58	2.38	2.79	2.5	10.5	12.3	99	3.61	A	A	3.96	5.19	1834	0.99
	15+15+60	1.43	1.43	5.73	---	2.87	8.60	10.18	0.58	2.16	2.51	2.5	9.5	11.0	99	3.98	A	A+	4.09	5.59	1913	1.08
	15+20+20	2.00	2.67	2.67	---	1.97	7.34	9.87	0.44	1.84	2.62	1.9	8.1	11.5	99	3.99	A	A	3.90	4.93	1771	0.95
	15+20+25	1.94	2.59	3.23	---	2.06	7.76	9.96	0.45	2.00	2.65	2.0	8.8	11.6	99	3.88	A	A	3.93	4.97	1772	0.94
	15+20+35	1.84	2.46	4.30	---	2.26	8.60	10.05	0.47	2.38	2.80	2.1	10.5	12.3	99	3.61	A	A	3.98	5.31	1868	1.00
	15+20+42	1.68	2.23	4.69	---	2.26	8.60	10.06	0.47	2.38	2.79	2.1	10.5	12.3	99	3.61	A	A	3.98	5.34	1877	1.03
	15+20+50	1.52	2.02	5.06	---	2.66	8.60	10.46	0.58	2.38	2.87	2.5	10.5	12.6	99	3.61	A	A	3.99	5.27	1850	1.01
	15+20+60	1.36	1.81	5.43	---	2.87	8.60	10.47	0.58	2.16	2.59	2.5	9.5	11.4	99	3.98	A	A+	4.10	5.66	1934	1.10
	15+25+25	1.89	3.15	3.15	---	2.16	8.18	10.07	0.48	2.18	2.65	2.1	9.6	11.6	99	3.75	A	A	3.94	5.01	1780	0.97
	15+25+35	1.72	2.87	4.01	---	2.35	8.60	10.17	0.50	2.38	2.79	2.2	10.5	12.3	99	3.61	A	A	3.99	5.35	1880	1.04
	15+25+42	1.57	2.62	4.40	---	2.36	8.60	10.17	0.50	2.38	2.79	2.2	10.5	12.3	99	3.61	A	A+	4.02	5.38	1876	1.02
	15+25+50	1.43	2.39	4.78	---	2.75	8.60	10.58	0.60	2.38	2.87	2.6	10.5	12.6	99	3.61	A	A	3.98	5.31	1868	1.00
	15+25+60	1.29	2.15	5.16	---	2.96	8.60	10.36	0.61	2.16	2.59	2.7	9.5	11.4	99	3.98	A	A+	4.10	5.69	1945	1.08
	15+35+35	1.52	3.54	3.54	---	2.64	8.60	10.18	0.58	2.38	2.79	2.5	10.5	12.3	99	3.61	A	A+	4.09	5.66	1937	1.10
	15+35+42	1.40	3.27	3.93	---	2.64	8.60	10.18	0.58	2.37	2.78	2.5	10.4	12.2	99	3.63	A	A+	4.08	5.69	1951	1.09
	15+35+50	1.29	3.01	4.30	---	2.94	8.60	10.51	0.66	2.37	2.82	2.9	10.4	12.4	99	3.63	A	A+	4.09	5.62	1926	1.06
	15+35+60	1.17	2.74	4.69	---	2.87	8.60	10.37	0.58	2.15	2.58	2.5	9.4	11.3	99	4.00	A	A+	4.17	5.82	1954	1.11
	15+42+42	1.30	3.65	3.65	---	2.64	8.60	10.27	0.58	2.37	2.82	2.5	10.4	12.4	99	3.63	A	A+	4.10	5.71	1952	1.10
15+42+50	1.21	3.38	4.02	---	2.94	8.60	10.57	0.66	2.37	2.90	2.9	10.4	12.7	99	3.63	A	A+	4.09	5.65	1935	1.09	
20+20+20	2.63	2.63	2.63	---	1.97	7.89	10.04	0.44	2.05	2.70	1.9	9.0	11.9	99	3.85	A	A	3.94	5.01	1780	0.97	
20+20+25	2.54	2.54	3.17	---	2.06	8.25	10.12	0.45	2.18	2.74	2.0	9.6	12.0	99	3.78	A	A	3.94	5.05	1794	0.96	
20+20+35	2.29	2.29	4.02	---	2.26	8.60	10.22	0.47	2.34	2.88	2.1	10.3	12.6	99	3.68	A	A+	4.02	5.39	1879	1.03	
20+20+42	2.10	2.10	4.40	---	2.26	8.60	10.22	0.47	2.34	2.88	2.1	10.3	12.6	99	3.68	A	A+	4.02	5.42	1888	1.05	
20+20+50	1.91	1.91	4.78	---	2.66	8.60	10.40	0.58	2.34	2.96	2.5	10.3	13.0	99	3.68	A	A	3.99	5.35	1880	1.04	
20+20+60	1.72	1.72	5.16	---	2.87	8.60	10.53	0.58	2.12	2.67	2.5	9.3	11.7	99	4.06	A	A+	4.09	5.73	1960	1.08	
20+25+25	2.46	3.07	3.07	---	2.16	8.60	10.13	0.46	2.35	2.84	2.0	10.3	12.5	99	3.66	A	A	3.94	5.09	1807	0.99	
20+25+35	2.15	2.69	3.76	---	2.35	8.60	10.22	0.49	2.34	2.88	2.2	10.3	12.6	99	3.68	A	A+	4.02	5.42	1888	1.05	
20+25+42	1.98	2.47	4.15	---	2.36	8.60	10.23	0.49	2.34	2.87	2.2	10.3	12.6	99	3.68	A	A+	4.02	5.45	1899	1.04	
20+25+50	1.81	2.26	4.53	---	2.75	8.60	10.63	0.60	2.32	2.99	2.6	10.2	13.1	99	3.71	A	A+	4.02	5.39	1879	1.03	
20+25+60	1.64	2.05	4.91	---	2.96	8.60	10.64	0.60	2.10	2.64	2.6	9.2	11.6	99	4.10	A	A+	4.13	5.76	1952	1.11	
20+35+35	1.92	3.34	3.34	---	2.64	8.60	10.35	0.55	2.31	2.93	2.4	10.1	12.9	99	3.72	A						

Combination tables

Heating

Outdoor unit	Indoor unit	Heating capacity (kW)				Total capacity (kW)			Power input (kW)			Total current (A)			Power factor (%)	COP	Energy label	Seasonal data				
		A room	B room	C room	D room	Min.	Nom.	Max.	Min.	Nom.	Max.	Min.	Nom.	Max.				Label	SCOP	Pdesign	AEC	Back-up heater capacity at -10°C
4MXS68F	15+15+20+20	1.84	1.84	2.46	2.46	2.42	8.60	10.04	0.52	1.94	2.46	2.3	8.5	10.8	99	4.43	A	A+	4.15	5.78	1953	1.13
	15+15+20+25	1.72	1.72	2.29	2.87	2.52	8.60	10.13	0.53	1.94	2.42	2.3	8.5	10.6	99	4.43	A	A+	4.15	5.79	1953	1.13
	15+15+20+35	1.52	1.52	2.02	3.54	2.72	8.60	10.23	0.57	1.94	2.47	2.5	8.5	10.8	99	4.43	A	A+	4.27	5.83	1913	1.12
	15+15+20+42	1.40	1.40	1.87	3.93	2.73	8.60	10.24	0.56	1.93	2.47	2.5	8.5	10.8	99	4.46	A	A+	4.30	5.83	1900	1.11
	15+15+20+50	1.29	1.29	1.72	4.30	3.04	8.60	10.30	0.63	1.89	2.39	2.8	8.3	10.5	99	4.55	A	A+	4.26	5.83	1917	1.12
	15+15+20+60	1.17	1.17	1.56	4.69	2.98	8.60	10.64	0.48	1.66	2.22	2.1	7.3	9.7	99	5.18	A	A+	4.42	5.84	1852	1.12
	15+15+25+25	1.61	1.61	2.69	2.69	2.62	8.60	10.14	0.55	1.94	2.42	2.4	8.5	10.6	99	4.43	A	A+	4.18	5.80	1943	1.10
	15+15+25+35	1.43	1.43	2.39	3.34	2.92	8.60	10.24	0.63	1.94	2.47	2.8	8.5	10.8	99	4.43	A	A+	4.30	5.83	1898	1.11
	15+15+25+42	1.33	1.33	2.22	3.72	2.92	8.60	10.24	0.62	1.93	2.47	2.7	8.5	10.8	99	4.46	A	A+	4.31	5.84	1897	1.12
	15+15+25+50	1.23	1.23	2.05	4.10	3.04	8.60	10.48	0.63	1.89	2.46	2.8	8.3	10.8	99	4.55	A	A+	4.27	5.83	1913	1.12
	15+15+25+55	1.29	1.29	3.01	3.01	3.12	8.60	10.34	0.68	1.93	2.50	3.0	8.5	11.0	99	4.46	A	A+	4.41	5.84	1855	1.12
	15+15+25+62	1.21	1.21	2.81	3.38	2.93	8.60	10.43	0.62	1.89	2.54	2.7	8.3	11.2	99	4.55	A	A+	4.41	5.84	1854	1.12
	15+20+20+20	1.72	2.29	2.29	2.29	2.42	8.60	10.22	0.52	1.94	2.54	2.3	8.5	11.2	99	4.43	A	A+	4.18	5.80	1943	1.10
	15+20+20+25	1.61	2.15	2.15	2.69	2.52	8.60	10.31	0.53	1.94	2.49	2.3	8.5	10.9	99	4.43	A	A+	4.19	5.81	1944	1.11
	15+20+20+35	1.43	1.91	1.91	3.34	2.72	8.60	10.41	0.57	1.94	2.55	2.5	8.5	11.2	99	4.43	A	A+	4.32	5.84	1895	1.12
	15+20+20+42	1.33	1.77	1.77	3.72	2.73	8.60	10.42	0.56	1.93	2.55	2.5	8.5	11.2	99	4.46	A	A+	4.32	5.84	1895	1.12
	15+20+20+50	1.23	1.64	1.64	4.10	3.04	8.60	10.48	0.63	1.89	2.46	2.8	8.3	10.8	99	4.55	A	A+	4.30	5.83	1898	1.11
	15+20+25+25	1.52	2.02	2.53	2.53	2.62	8.60	10.31	0.55	1.94	2.49	2.4	8.5	10.9	99	4.43	A	A+	4.19	5.81	1942	1.11
	15+20+25+35	1.36	1.81	2.26	3.17	2.92	8.60	10.41	0.63	1.94	2.55	2.8	8.5	11.2	99	4.43	A	A+	4.32	5.84	1895	1.12
	15+20+25+42	1.26	1.69	2.11	3.54	2.92	8.60	10.42	0.62	1.93	2.55	2.7	8.5	11.2	99	4.46	A	A+	4.33	5.84	1890	1.12
	15+20+25+50	1.17	1.56	1.95	3.91	3.04	8.60	10.66	0.63	1.89	2.54	2.8	8.3	11.2	99	4.55	A	A+	4.32	5.84	1895	1.12
	15+20+35+35	1.23	1.64	2.87	2.87	3.12	8.60	10.51	0.68	1.93	2.58	3.0	8.5	11.3	99	4.46	A	A+	4.42	5.84	1852	1.12
	15+25+25+25	1.43	2.39	2.39	2.39	2.72	8.60	10.32	0.58	1.94	2.49	2.5	8.5	10.9	99	4.43	A	A+	4.19	5.81	1940	1.10
	15+25+25+35	1.29	2.15	2.15	3.01	3.02	8.60	10.50	0.66	1.93	2.59	2.9	8.5	11.4	99	4.46	A	A+	4.36	5.84	1877	1.12
	15+25+25+42	1.21	2.01	2.01	3.38	2.92	8.60	10.59	0.62	1.93	2.62	2.7	8.5	11.5	99	4.46	A	A+	4.36	5.84	1875	1.12
	15+25+35+35	1.17	1.95	2.74	2.74	3.12	8.60	10.60	0.68	1.90	2.62	3.0	8.3	11.5	99	4.53	A	A+	4.48	5.84	1826	1.12
	20+20+20+20	2.15	2.15	2.15	2.15	2.42	8.60	10.39	0.52	1.91	2.61	2.3	8.4	11.5	99	4.50	A	A+	4.19	5.81	1942	1.11
	20+20+20+25	2.02	2.02	2.02	2.54	2.52	8.60	10.48	0.53	1.91	2.57	2.3	8.4	11.3	99	4.50	A	A+	4.20	5.82	1940	1.11
	20+20+20+35	1.81	1.81	1.81	3.17	2.72	8.60	10.58	0.57	1.90	2.63	2.5	8.3	11.6	99	4.53	A	A+	4.36	5.84	1877	1.12
	20+20+20+42	1.69	1.69	1.69	3.54	2.73	8.60	10.59	0.56	1.90	2.63	2.5	8.3	11.6	99	4.53	A	A+	4.36	5.84	1875	1.12
	20+20+20+50	1.56	1.56	1.56	3.92	3.04	8.60	10.65	0.63	1.86	2.54	2.8	8.2	11.2	99	4.62	A	A+	4.33	5.84	1890	1.12
	20+20+25+25	1.91	1.91	2.39	2.39	2.62	8.60	10.49	0.55	1.91	2.57	2.4	8.4	11.3	99	4.50	A	A+	4.23	5.82	1925	1.11
	20+20+25+35	1.72	1.72	2.15	3.01	2.92	8.60	10.59	0.60	1.90	2.63	2.6	8.3	11.6	99	4.53	A	A+	4.36	5.84	1875	1.12
	20+20+25+42	1.61	1.61	2.01	3.38	2.92	8.60	10.59	0.60	1.90	2.63	2.6	8.3	11.6	99	4.53	A	A+	4.37	5.84	1873	1.12
	20+20+35+35	1.56	1.56	2.74	2.74	3.12	8.60	10.69	0.65	1.90	2.66	2.9	8.3	11.7	99	4.53	A	A+	4.48	5.84	1824	1.13
	20+25+25+25	1.82	2.26	2.26	2.26	2.72	8.60	10.49	0.57	1.91	2.57	2.5	8.4	11.3	99	4.50	A	A+	4.24	5.82	1923	1.11
	20+25+25+35	1.64	2.05	2.05	2.86	3.02	8.60	10.68	0.63	1.90	2.67	2.8	8.3	11.7	99	4.53	A	A+	4.37	5.84	1873	1.12
	25+25+25+25	2.15	2.15	2.15	2.15	2.82	8.60	10.67	0.57	1.91	2.59	2.5	8.4	11.4	99	4.50	A	A+	4.26	5.83	1915	1.12
	25+25+25+35	1.95	1.95	1.95	2.75	3.12	8.60	10.68	0.64	1.88	2.58	2.8	8.3	11.3	99	4.57	A	A+	4.37	5.84	1871	1.12

- Notes:
- Cooling capacity is based on 27°CDB/19°CWB (Indoor temperature), 35°CDB (Outdoor temperature). Heating capacity is based on 20°CDB (Indoor temperature), 7°CDB/6°CWB (Outdoor temperature).
 - The total ability of connected indoor unit is up to 11.0kW.
 - It is impossible to connect the indoor unit for one room only.
 - The above is the value for connecting with the following indoor units.
 1.5kW: wall mounted CTXS-K series; 2.0, 2.5, 3.5, 4.2, 5.0kW: wall mounted FTXS-K series
 6.0 kW class: wall mounted G series

Combination tables

Cooling

Outdoor unit	Indoor unit	Cooling capacity (kW)				Total capacity (kW)			Power input (kW)			Total current (A)			Power factor (%)	EER	Energy label	AEC (kWh)	Seasonal data			
		A room	B room	C room	D room	Min.	Nom.	Max.	Min.	Nom.	Max.	Min.	Nom.	Max.					Label	SEER	Pdesign	AEC
4MXS80E	1.5+1.5	1.50	1.50	---	---	1.89	3.00	4.03	0.46	0.83	1.09	2.0	3.7	4.8	98	3.61	A	415	A	5.15	3.00	204
	1.5+2.0	1.50	2.00	---	---	1.91	3.50	4.51	0.50	1.00	1.28	2.2	4.4	5.7	98	3.50	A	500	A	5.38	3.50	228
	1.5+2.5	1.50	2.50	---	---	1.97	4.00	4.97	0.46	1.14	1.38	2.0	5.1	6.1	98	3.51	A	570	A	5.54	4.00	253
	1.5+3.5	1.50	3.50	---	---	2.07	5.00	5.83	0.46	1.52	1.82	2.0	6.7	8.1	98	3.29	A	760	A	5.56	5.00	315
	1.5+4.2	1.50	4.20	---	---	2.14	5.70	6.38	0.50	1.88	2.10	2.2	8.3	9.3	98	3.03	B	940	A+	5.61	5.70	356
	1.5+5.0	1.50	5.00	---	---	2.22	6.50	6.95	0.51	2.22	2.51	2.3	9.8	11.1	98	2.93	C	1110	A+	5.62	6.50	406
	1.5+6.0	1.44	5.75	---	---	2.34	7.19	7.59	0.55	2.42	2.67	2.4	10.7	11.8	98	2.97	C	1210	A+	5.98	7.19	421
	1.5+7.1	1.30	6.15	---	---	2.49	7.45	8.19	0.59	2.61	3.08	2.6	11.6	13.7	98	2.85	C	1305	A+	5.97	7.45	437
	2.0+2.0	2.00	2.00	---	---	1.97	4.00	5.30	0.50	1.23	1.67	2.2	5.5	7.4	98	3.25	A	615	A	5.57	4.00	252
	2.0+2.5	2.00	2.50	---	---	2.02	4.50	5.73	0.50	1.38	1.77	2.2	6.1	7.9	98	3.26	A	690	A+	5.66	4.50	279
	2.0+3.5	2.00	3.50	---	---	2.12	5.50	6.31	0.50	1.77	2.44	2.2	7.9	10.8	98	3.11	B	885	A+	5.64	5.50	342
	2.0+4.2	2.00	4.20	---	---	2.19	6.20	6.77	0.50	2.21	2.56	2.2	9.8	11.4	98	2.81	C	1105	A+	5.73	6.20	379
	2.0+5.0	2.00	5.00	---	---	2.27	7.00	7.30	0.51	2.51	2.76	2.3	11.1	12.2	98	2.79	D	1255	A	5.59	7.00	439
	2.0+6.0	1.83	5.48	---	---	2.41	7.31	7.90	0.55	2.48	2.87	2.4	11.0	12.7	98	2.95	C	1240	A+	6.03	7.31	424
	2.0+7.1	1.66	5.90	---	---	2.56	7.56	8.45	0.59	2.67	3.29	2.6	11.8	14.6	98	2.83	C	1335	A+	6.01	7.56	441
	2.5+2.5	2.50	2.50	---	---	2.07	5.00	6.12	0.46	1.47	2.44	2.0	6.5	10.8	98	3.40	A	735	A+	5.70	5.00	307
	2.5+3.5	2.50	3.50	---	---	2.17	6.00	6.60	0.50	1.99	2.38	2.2	8.8	10.6	98	3.02	B	925	A+	5.70	6.00	369
	2.5+4.2	2.50	4.20	---	---	2.24	6.70	7.11	0.50	2.44	2.63	2.2	10.8	11.7	98	2.75	D	1190	A+	5.69	6.70	412
	2.5+5.0	2.40	4.79	---	---	2.34	7.19	7.59	0.54	2.64	2.96	2.4	11.7	13.1	98	2.72	D	1320	A	5.57	7.19	452
	2.5+6.0	2.18	5.24	---	---	2.48	7.42	8.16	0.59	2.60	3.07	2.6	11.5	13.6	98	2.85	C	1300	A+	6.00	7.42	433
	2.5+7.1	2.00	5.68	---	---	2.63	7.68	8.66	0.59	2.74	3.43	2.6	12.2	15.2	98	2.80	C	1370	A	5.99	7.68	449
	3.5+3.5	3.50	3.50	---	---	2.27	7.00	7.30	0.50	2.63	2.88	2.2	11.7	12.8	98	2.66	D	1315	A	5.55	7.00	442
	3.5+4.2	3.29	3.95	---	---	2.37	7.24	7.73	0.54	2.82	3.08	2.4	12.5	13.7	98	2.57	E	1410	A	5.53	7.24	458
	3.5+5.0	3.06	4.36	---	---	2.48	7.42	8.16	0.58	2.83	3.37	2.6	12.6	15.0	98	2.62	D	1415	A	5.50	7.42	473
	3.5+6.0	2.82	4.83	---	---	2.61	7.65	8.62	0.59	2.74	4.11	2.6	12.2	18.2	98	2.79	D	1370	A+	5.91	7.65	454
	3.5+7.1	2.61	5.30	---	---	2.77	7.91	8.31	0.63	2.87	3.15	2.8	12.7	14.0	98	2.76	D	1435	A+	5.93	7.91	467
	4.2+4.2	3.70	3.70	---	---	2.46	7.40	8.11	0.58	2.88	3.42	2.6	12.8	15.2	98	2.57	E	1440	A	5.54	7.40	468
	4.2+5.0	3.46	4.12	---	---	2.57	7.58	8.48	0.58	2.96	3.59	2.6	13.1	15.9	98	2.56	E	1480	A	5.49	7.58	484
	4.2+6.0	3.22	4.60	---	---	2.71	7.82	8.89	0.63	2.80	3.66	2.8	12.4	16.2	98	2.79	D	1400	A+	5.92	7.82	463
	4.2+7.1	2.97	5.03	---	---	2.86	8.00	9.16	0.67	2.94	3.82	3.0	13.0	16.9	98	2.72	D	1470	A+	5.93	8.00	472
	5.0+5.0	3.88	3.88	---	---	2.68	7.76	8.66	0.62	2.98	3.62	2.8	13.2	16.1	98	2.60	D	1490	A	5.41	7.76	503
	5.0+6.0	3.64	4.36	---	---	2.82	8.00	9.14	0.67	2.88	3.69	3.0	12.8	16.4	98	2.78	D	1440	A+	5.89	8.00	476
	5.0+7.1	3.31	4.69	---	---	2.97	8.00	9.35	0.67	2.82	3.85	3.0	12.5	17.1	98	2.84	C	1410	A+	5.92	8.00	474
	6.0+6.0	4.00	4.00	---	---	2.96	8.00	9.39	0.67	2.65	3.60	3.0	11.8	16.0	98	3.02	B	1325	A++	6.29	8.00	446
	6.0+7.1	3.66	4.34	---	---	3.11	8.00	9.55	0.71	2.58	3.76	3.1	11.4	16.7	98	3.10	B	1290	A++	6.30	8.00	445
	7.1+7.1	4.00	4.00	---	---	3.26	8.00	9.60	0.75	2.51	3.77	3.3	11.1	16.7	98	3.19	B	1255	A++	6.33	8.00	443
	1.5+1.5+1.5	1.50	1.50	1.50	---	2.02	4.50	5.41	0.48	1.14	1.47	2.1	5.1	6.5	98	3.95	A	570	A+	5.77	4.50	274
	1.5+1.5+2.0	1.50	1.50	2.00	---	2.07	5.00	5.83	0.52	1.28	1.67	2.3	5.7	7.4	98	3.91	A	640	A+	5.90	5.00	297
	1.5+1.5+2.5	1.50	1.50	2.50	---	2.12	5.50	6.23	0.52	1.52	1.89	2.3	6.7	8.4	98	3.62	A	760	A+	5.95	5.50	324
	1.5+1.5+3.5	1.50	1.50	3.50	---	2.22	6.50	6.95	0.52	2.00	2.29	2.3	8.9	10.2	98	3.25	A	1000	A+	5.99	6.50	380
	1.5+1.5+4.2	1.48	1.48	4.15	---	2.30	7.12	7.41	0.52	2.35	2.54	2.3	10.4	11.3	98	3.03	B	1175	A+	5.95	7.12	419
	1.5+1.5+5.0	1.37	1.37	4.57	---	2.41	7.31	7.88	0.56	2.43	2.75	2.5	10.8	12.2	98	3.01	B	1215	A+	5.91	7.31	434
	1.5+1.5+6.0	1.26	1.26	5.03	---	2.55	7.54	8.38	0.60	2.32	2.85	2.7	10.3	12.6	98	3.25	A	1160	A++	6.23	7.54	424
	1.5+1.5+7.1	1.16	1.16	5.48	---	2.70	7.79	8.84	0.64	2.45	3.14	2.8	10.9	13.9	98	3.18	B	1225	A++	6.25	7.79	437
	1.5+2.0+2.0	1.50	2.00	2.00	---	2.12	5.50	6.23	0.52	1.52	1.89	2.3	6.7	8.4	98	3.62	A	760	A+	5.99	5.50	322
1.5+2.0+2.5	1.50	2.00	2.50	---	2.17	6.00	6.60	0.52	1.73	2.06	2.3	7.7	9.1	98	3.47	A	865	A+	6.05	6.00	348	
1.5+2.0+3.5	1.50	2.00	3.50	---	2.27	7.00	7.28	0.52	2.29	2.48	2.3	10.2	11.0	98	3.06	B	1145	A+	6.01	7.00	408	
1.5+2.0+4.2	1.41	1.88	3.95	---	2.37	7.24	7.71	0.55	2.42	2.74	2.4	10.7	12.2	98	2.99	C	1210	A+	5.99	7.24	424	
1.5+2.0+5.0	1.31	1.75	4.36	---	2.48	7.42	8.14	0.59	2.49	2.95	2.6	11.0	13.1	98	2.98	C	1245	A+	5.96	7.42	436	
1.5+2.0+6.0	1.21	1.61	4.83	---	2.61	7.65	8.60	0.60	2.38	3.00	2.7	10.6	13.3	98	3.21	A	1190	A++	6.30	7.65	425	
1.5+2.0+7.1	1.12	1.49	5.30	---	2.77	7.91	9.01	0.64	2.51	3.29	2.8	11.1	14.6	98	3.15	B	1255	A++	6.28	7.91	442	
1.5+2.5+2.5	1.50	2.50	2.50	---	2.22	6.50	6.95	0.52	2.00	2.29	2.3	8.9	10.2	98	3.25	A	1000	A++	6.12	6.50	373	
1.5+2.5+3.5	1.44	2.40	3.36	---	2.34	7.19	7.59	0.55	2.42	2.67	2.4	10.7	11.8	98	2.97	C	1210	A+	5.97	7.19	422	
1.5+2.5+4.2	1.34	2.24	3.76	---	2.44	7.35	7.99	0.55	2.54	2.94	2.4	11.3	13.0	98	2.89	C	1270	A+	5.97	7.35	431	
1.5+2.5+5.0	1.26	2.09	4.19	---	2.55	7.54	8.38	0.59	2.55	3.10	2.6	11.3	13.8	98	2.96	C	1275	A+	5.96	7.54	443	
1.5+2.5+6.0	1.17	1.94	4.66	---	2.68	7.77	8.80	0.60	2.45	3.14	2.7	10.9	13.9	98	3.17	B	1225	A++	6.26	7.77	435	
1.5+2.5+7.1	1.08	1.80	5.12	---	2.83	8.00	9.16	0.64	2.58	3.37	2.8	11.4	15.0	98	3.10	B	1290	A++	6.26	8.00	448	
1.5+3.5+3.5	1.31	3.06	3.06	---	2.48	7.42	8.14	0.59	2.54	3.08	2.6	11.3	13.7	98	2.92	C	1270	A+	5.90	7.42	441	
1.5+3.5+4.2	1.24	2.88	3.46	---	2.57	7.58	8.47	0.59	2.67	3.29	2.6	11.8	14.6	98	2.84	C	1335	A+	5.94	7.58	447	
1.5+3.5+5.0	1.17	2.72	3.89	---	2.68	7.77	8.80	0.63	2.68	3.46	2.8	11.9	15.4	98	2.90	C	1340	A+	5.88	7.77	463	
1.5+3.5+6.0	1.09	2.55	4.36	---	2.82	8.00	9.13	0.64	2.58	3.37	2.8	11.4	15.0	98	3.10	B	1290	A++	6.17	8.00	454	
1.5+3.5+7.1	0.99	2.31	4.69	---	2.97	8.00	9.39	0.67	2.51	3.61	3.0	11.1	16.0	98	3.19	B	1255	A++	6.19	8.00	453	
1.5+4.2+4.2	1.17	3.29	3.29	---	2.67	7.75	8.76	0.63	2.67	3.51	2.8	11.8	15.6	98	2.90	C	1335	A+	5.93	7.75	458	
1.5+4.2+5.0	1.11	3.																				

Combination tables

Cooling

Outdoor unit	Indoor unit	Cooling capacity (kW)				Total capacity (kW)			Power input (kW)			Total current (A)			Power factor (%)	EER	Energy label	AEC (kWh)	Seasonal data			
		A room	B room	C room	D room	Min.	Nom.	Max.	Min.	Nom.	Max.	Min.	Nom.	Max.					Label	SEER	Pdesign	AEC
4MXS80E	2.0+3.5+3.5	1.68	2.93	2.93	---	2.55	7.54	8.40	0.59	2.67	3.22	2.6	11.8	14.3	98	2.82	C	1335	A+	5.99	7.54	441
	2.0+3.5+4.2	1.59	2.78	3.33	---	2.64	7.70	8.70	0.63	2.74	3.37	2.8	12.2	15.0	98	2.81	C	1370	A+	5.97	7.70	452
	2.0+3.5+5.0	1.50	2.63	3.75	---	2.75	7.88	8.99	0.63	2.75	3.61	2.8	12.2	16.0	98	2.87	C	1375	A+	5.92	7.88	467
	2.0+3.5+6.0	1.39	2.43	4.17	---	2.89	8.00	9.28	0.67	2.58	3.52	3.0	11.4	15.6	98	3.10	B	1290	A++	6.20	8.00	452
	2.0+3.5+7.1	1.27	2.22	4.51	---	3.04	8.00	9.10	0.67	2.51	3.30	3.0	11.1	14.6	98	3.19	B	1255	A++	6.21	8.00	451
	2.0+4.2+4.2	1.51	3.17	3.17	---	2.74	7.86	8.99	0.63	2.74	3.66	2.8	12.2	16.2	98	2.87	C	1370	A+	5.95	7.86	463
	2.0+4.2+5.0	1.43	3.00	3.57	---	2.85	8.00	9.23	0.67	2.75	3.77	3.0	12.2	16.7	98	2.91	C	1375	A+	5.92	8.00	473
	2.0+4.2+6.0	1.31	2.75	3.93	---	2.98	8.00	9.45	0.67	2.51	3.60	3.0	11.1	16.0	98	3.19	B	1255	A++	6.21	8.00	451
	2.0+4.2+7.1	1.20	2.53	4.27	---	3.14	8.00	9.60	0.71	2.52	3.69	3.1	11.2	16.4	98	3.17	B	1260	A++	6.25	8.00	449
	2.0+5.0+5.0	1.33	3.33	3.33	---	2.96	8.00	9.39	0.67	2.76	3.80	3.0	12.2	16.9	98	2.90	C	1380	A+	5.90	8.00	475
	2.0+5.0+6.0	1.23	3.08	3.69	---	3.09	8.00	9.54	0.71	2.46	3.63	3.1	10.9	16.1	98	3.25	A	1230	A++	6.21	8.00	451
	2.0+5.0+7.1	1.13	2.84	4.03	---	3.25	8.00	9.60	0.71	2.39	3.63	3.1	10.6	16.1	98	3.35	A	1195	A++	6.24	8.00	449
	2.0+6.0+6.0	1.14	3.43	3.43	---	3.23	8.00	9.60	0.72	2.28	3.37	3.2	10.1	15.0	98	3.51	A	1140	A++	6.36	8.00	441
	2.5+2.5+2.5	2.40	2.40	2.40	---	2.34	7.20	7.61	0.55	2.42	2.67	2.4	10.7	11.8	98	2.98	C	1210	A++	6.12	7.20	412
	2.5+2.5+3.5	2.18	2.18	3.06	---	2.48	7.42	8.16	0.59	2.54	3.08	2.6	11.3	13.7	98	2.92	C	1270	A+	6.04	7.42	431
	2.5+2.5+4.2	2.06	2.06	3.46	---	2.57	7.58	8.49	0.59	2.67	3.29	2.6	11.8	14.6	98	2.84	C	1335	A+	6.03	7.58	441
	2.5+2.5+5.0	1.94	1.94	3.89	---	2.68	7.77	8.82	0.63	2.68	3.46	2.8	11.9	15.4	98	2.90	C	1340	A+	6.01	7.77	453
	2.5+2.5+6.0	1.82	1.82	4.36	---	2.82	8.00	9.15	0.64	2.58	3.45	2.8	11.4	15.3	98	3.10	B	1290	A++	6.26	8.00	448
	2.5+2.5+7.1	1.65	1.65	4.69	---	2.97	8.00	9.41	0.67	2.51	3.61	3.0	11.1	16.0	98	3.19	B	1255	A++	6.29	8.00	446
	2.5+3.5+3.5	2.01	2.82	2.82	---	2.61	7.65	8.34	0.59	2.74	3.01	2.6	12.2	13.4	98	2.79	D	1370	A+	5.98	7.65	448
	2.5+3.5+4.2	1.92	2.68	3.22	---	2.71	7.82	8.89	0.63	2.80	3.44	2.8	12.4	15.3	98	2.79	D	1400	A+	5.96	7.82	460
	2.5+3.5+5.0	1.82	2.55	3.64	---	2.82	8.00	9.15	0.67	2.82	3.69	3.0	12.5	16.4	98	2.84	C	1410	A+	5.90	8.00	475
	2.5+3.5+6.0	1.67	2.33	4.00	---	2.96	8.00	9.39	0.67	2.58	3.60	3.0	11.4	16.0	98	3.10	B	1290	A++	6.21	8.00	451
	2.5+3.5+7.1	1.53	2.14	4.34	---	3.11	8.00	9.10	0.71	2.51	3.30	3.1	11.1	14.6	98	3.19	B	1255	A++	6.25	8.00	449
	2.5+4.2+4.2	1.83	3.07	3.07	---	2.81	7.98	9.02	0.67	2.87	3.67	3.0	12.7	16.3	98	2.78	D	1435	A+	5.93	7.98	471
	2.5+4.2+5.0	1.71	2.87	3.42	---	2.92	8.00	9.35	0.67	2.82	3.85	3.0	12.5	17.1	98	2.84	C	1410	A+	5.93	8.00	473
	2.5+4.2+6.0	1.57	2.65	3.78	---	3.05	8.00	9.53	0.67	2.58	3.68	3.0	11.4	16.3	98	3.10	B	1290	A++	6.21	8.00	451
	2.5+4.2+7.1	1.45	2.43	4.12	---	3.20	8.00	9.63	0.71	2.52	3.77	3.1	11.2	16.7	98	3.17	B	1260	A++	6.25	8.00	449
	2.5+5.0+5.0	1.60	3.20	3.20	---	3.03	8.00	9.47	0.71	2.76	3.88	3.1	12.2	17.2	98	2.90	C	1380	A+	5.90	8.00	475
	2.5+5.0+6.0	1.48	2.96	3.56	---	3.16	8.00	9.58	0.71	2.46	3.63	3.1	10.9	16.1	98	3.25	A	1230	A++	6.21	8.00	451
	2.5+6.0+6.0	1.38	3.31	3.31	---	3.30	8.00	9.60	0.72	2.22	3.37	3.2	9.8	15.0	98	3.60	A	1110	A++	6.36	8.00	441
	3.5+3.5+3.5	2.63	2.63	2.63	---	2.75	7.89	8.67	0.63	2.87	3.15	2.8	12.7	14.0	98	2.75	D	1435	A+	5.86	7.89	472
	3.5+3.5+4.2	2.50	2.50	3.00	---	2.85	8.01	9.29	0.67	2.94	3.66	3.0	13.0	16.2	98	2.72	D	1470	A+	5.87	8.00	478
	3.5+3.5+5.0	2.33	2.33	3.33	---	2.96	8.00	9.35	0.67	2.82	3.85	3.0	12.5	17.1	98	2.84	C	1410	A+	5.86	8.00	478
	3.5+3.5+6.0	2.15	2.15	3.69	---	3.09	8.00	9.11	0.71	2.58	3.37	3.1	11.4	15.0	98	3.10	B	1290	A++	6.14	8.00	456
	3.5+3.5+7.1	1.99	1.99	4.03	---	3.25	8.00	9.60	0.75	2.52	3.77	3.3	11.2	16.7	98	3.17	B	1260	A++	6.18	8.00	454
	3.5+4.2+4.2	2.35	2.82	2.82	---	2.94	8.00	9.18	0.67	2.87	3.82	3.0	12.7	16.9	98	2.79	D	1435	A+	5.88	8.00	477
	3.5+4.2+5.0	2.20	2.65	3.15	---	3.05	8.00	9.36	0.71	2.75	3.85	3.1	12.2	17.1	98	2.91	C	1375	A+	5.88	8.00	477
	3.5+4.2+6.0	2.04	2.45	3.50	---	3.19	8.00	9.59	0.71	2.51	3.77	3.1	11.1	16.7	98	3.19	B	1255	A++	6.17	8.00	455
	3.5+5.0+5.0	2.07	2.96	2.96	---	3.16	8.00	9.55	0.71	2.76	3.88	3.1	12.2	17.2	98	2.90	C	1380	A+	5.86	8.00	478
	3.5+5.0+6.0	1.93	2.76	3.31	---	3.30	8.00	9.60	0.75	2.46	3.63	3.3	10.9	16.1	98	3.25	A	1230	A++	6.14	8.00	456
	4.2+4.2+4.2	2.67	2.67	2.67	---	3.04	8.00	9.19	0.71	2.87	3.82	3.1	12.7	16.9	98	2.79	D	1435	A+	5.88	8.00	476
	4.2+4.2+5.0	2.51	2.51	2.99	---	3.15	8.00	9.37	0.71	2.75	3.85	3.1	12.2	17.1	98	2.91	C	1375	A+	5.88	8.00	477
	4.2+4.2+6.0	2.33	2.33	3.33	---	3.29	8.00	9.60	0.75	2.51	3.77	3.3	11.1	16.7	98	3.19	B	1255	A++	6.17	8.00	454
4.2+5.0+5.0	2.37	2.82	2.82	---	3.26	8.00	9.56	0.75	2.70	3.88	3.3	12.0	17.2	98	2.96	C	1350	A+	5.88	8.00	477	
15+15+15+15+15	1.50	1.50	1.50	1.50	2.17	6.00	6.60	0.53	1.47	1.73	2.4	6.5	7.7	98	4.08	A	735	A++	6.10	6.00	345	
15+15+15+15+2.0	1.50	1.50	1.50	2.00	2.22	6.50	6.95	0.53	1.68	1.90	2.4	7.5	8.4	98	3.87	A	840	A++	6.17	6.50	369	
15+15+15+15+2.5	1.50	1.50	1.50	2.50	2.27	7.00	7.28	0.53	1.90	2.07	2.4	8.4	9.2	98	3.68	A	950	A++	6.22	7.00	394	
15+15+15+15+3.5	1.37	1.37	1.37	3.20	2.41	7.31	7.88	0.56	2.07	2.38	2.5	9.2	10.6	98	3.53	A	1035	A++	6.16	7.31	416	
15+15+15+15+4.2	1.29	1.29	1.29	3.61	2.50	7.47	8.24	0.56	2.13	2.58	2.5	9.4	11.4	98	3.51	A	1065	A++	6.17	7.47	424	
15+15+15+15+5.0	1.21	1.21	1.21	4.03	2.61	7.65	8.60	0.60	2.33	2.87	2.7	10.3	12.7	98	3.28	A	1165	A++	6.16	7.65	435	
15+15+15+15+6.0	1.13	1.13	1.13	4.50	2.75	7.88	8.97	0.61	2.22	2.91	2.7	9.8	12.9	98	3.55	A	1110	A++	6.31	7.88	438	
15+15+15+15+7.1	1.03	1.03	1.03	4.90	2.90	8.00	9.28	0.64	2.22	3.06	2.8	9.8	13.6	98	3.60	A	1110	A++	6.30	8.00	445	
15+15+15+2.0+2.0	1.50	1.50	2.00	2.00	2.27	7.00	7.28	0.53	1.90	2.07	2.4	8.4	9.2	98	3.68	A	950	A++	6.25	7.00	392	
15+15+15+2.0+2.5	1.44	1.44	1.92	2.40	2.34	7.19	7.59	0.56	2.02	2.20	2.5	9.0	9.8	98	3.56	A	1010	A++	6.25	7.19	403	
15+15+15+2.0+3.5	1.31	1.31	1.75	3.06	2.48	7.42	8.14	0.56	2.13	2.51	2.5	9.4	11.1	98	3.48	A	1065	A++	6.18	7.42	420	
15+15+15+2.0+4.2	1.24	1.24	1.65	3.46	2.57	7.58	8.47	0.60	2.20	2.72	2.7	9.8	12.1	98	3.45	A	1100	A++	6.19	7.58	429	
15+15+15+2.0+5.0	1.17	1.17	1.55	3.89	2.68	7.77	8.80	0.60	2.39	3.01	2.7	10.6	13.4	98	3.25	A	1195	A++	6.14	7.77	444	
15+15+15+2.0+6.0	1.09	1.09	1.45	4.36	2.82	8.00	9.13	0.64	2.28	2.98	2.8	10.1	13.2	98	3.51	A	1140	A++	6.30	8.00	445	
15+15+15+2.0+7.1	0.99	0.99	1.32	4.69	2.97	8.00	9.39	0.68	2.22	3.14	3.0	9.8	13.9	98	3.60	A	1110	A++	6.32	8.00	443	
15+15+15+2.5+2.5	1.37	1.37	2.28	2.28	2.41	7.31	7.88	0.56	2.07	2.38	2.5	9.2	10.6	98	3.53							

Combination tables

Cooling

Outdoor unit	Indoor unit	Cooling capacity (kW)				Total capacity (kW)			Power input (kW)			Total current (A)			Power factor (%)	EER	Energy label	AEC (kWh)	Seasonal data			
		A room	B room	C room	D room	Min.	Nom.	Max.	Min.	Nom.	Max.	Min.	Nom.	Max.					Label	SEER	Pdesign	AEC
4MXS80E	15x20x20+71	0.95	1.27	1.27	4.51	3.04	8.00	9.47	0.68	2.22	3.21	3.0	9.8	14.2	98	3.60	A	1110	A++	6.35	8.00	442
	15x20x25+25	1.31	1.75	2.18	2.18	2.48	7.42	8.14	0.56	2.13	2.51	2.5	9.4	11.1	98	3.48	A	1065	A++	6.30	7.42	413
	15x20x35+35	1.21	1.61	2.01	2.82	2.61	7.65	8.60	0.60	2.38	3.00	2.7	10.6	13.3	98	3.21	A	1190	A++	6.20	7.65	432
	15x20x42+42	1.15	1.53	1.92	3.22	2.71	7.82	8.87	0.64	2.51	3.22	2.8	11.1	14.3	98	3.12	B	1255	A++	6.17	7.82	444
	15x20x50+50	1.09	1.45	1.82	3.64	2.82	8.00	9.13	0.64	2.52	3.24	2.8	11.2	14.4	98	3.17	B	1260	A++	6.15	8.00	456
	15x20x25+60	1.00	1.33	1.67	4.00	2.96	8.00	9.37	0.68	2.28	3.13	3.0	10.1	13.9	98	3.51	A	1140	A++	6.32	8.00	443
	15x20x35+71	0.92	1.22	1.53	4.34	3.11	8.00	9.53	0.68	2.22	3.29	3.0	9.8	14.6	98	3.60	A	1110	A++	6.35	8.00	442
	15x20x35+35	1.13	1.50	2.63	2.63	2.75	7.88	8.97	0.64	2.51	3.30	2.8	11.1	14.6	98	3.14	B	1255	A+	6.09	7.88	453
	15x20x45+42	1.07	1.43	2.50	3.00	2.85	8.00	9.18	0.64	2.58	3.45	2.8	11.4	15.3	98	3.10	B	1290	A++	6.10	8.00	460
	15x20x35+50	1.00	1.33	2.33	3.33	2.96	8.00	9.37	0.68	2.52	3.47	3.0	11.2	15.4	98	3.17	B	1260	A+	6.08	8.00	461
	15x20x35+60	0.92	1.23	2.15	3.69	3.09	8.00	9.52	0.68	2.28	3.29	3.0	10.1	14.6	98	3.51	A	1140	A++	6.27	8.00	447
	15x20x35+71	0.85	1.13	1.99	4.03	3.25	8.00	9.58	0.72	2.22	3.29	3.2	9.8	14.6	98	3.60	A	1110	A++	6.27	8.00	447
	15x20x42+42	1.01	1.34	2.82	2.82	2.94	8.00	9.35	0.67	2.58	3.53	3.0	11.4	15.7	98	3.10	B	1290	A++	6.10	8.00	459
	15x20x42+50	0.94	1.26	2.65	3.15	3.05	8.00	9.48	0.68	2.52	3.55	3.0	11.2	15.7	98	3.17	B	1260	A++	6.10	8.00	459
	15x20x42+60	0.88	1.17	2.45	3.50	3.19	8.00	9.57	0.72	2.28	3.29	3.2	10.1	14.6	98	3.51	A	1140	A++	6.27	8.00	447
	15x20x50+50	0.89	1.19	2.96	2.96	3.16	8.00	9.56	0.71	2.40	3.50	3.1	10.6	15.5	98	3.33	A	1200	A++	6.10	8.00	460
	15x20x50+60	0.83	1.10	2.76	3.31	3.30	8.00	9.58	0.72	2.22	3.23	3.2	9.8	14.3	98	3.60	A	1110	A++	6.27	8.00	447
	15x25x25+25	1.26	2.09	2.09	2.09	2.55	7.54	8.38	0.60	2.20	2.65	2.7	9.8	11.8	98	3.43	A	1100	A++	6.28	7.54	421
	15x25x25+35	1.17	1.94	1.94	2.72	2.68	7.77	8.80	0.60	2.45	3.14	2.7	10.9	13.9	98	3.17	B	1225	A++	6.16	7.77	442
	15x25x25+42	1.11	1.85	1.85	3.11	2.78	7.93	9.04	0.64	2.58	3.30	2.8	11.4	14.6	98	3.07	B	1290	A++	6.17	7.93	450
	15x25x25+50	1.04	1.74	1.74	3.48	2.89	8.00	9.26	0.64	2.52	3.39	2.8	11.2	15.0	98	3.17	B	1260	A++	6.15	8.00	456
	15x25x25+60	0.96	1.60	1.60	3.84	3.03	8.00	9.45	0.68	2.28	3.21	3.0	10.1	14.2	98	3.51	A	1140	A++	6.32	8.00	443
	15x25x25+71	0.88	1.47	1.47	4.18	3.18	8.00	9.57	0.72	2.22	3.29	3.2	9.8	14.6	98	3.60	A	1110	A++	6.35	8.00	442
	15x25x35+35	1.09	1.82	2.55	2.55	2.82	8.00	9.13	0.64	2.58	3.37	2.8	11.4	15.0	98	3.10	B	1290	A++	6.10	8.00	460
	15x25x35+42	1.03	1.71	2.39	2.87	2.92	8.00	9.30	0.67	2.58	3.53	3.0	11.4	15.7	98	3.10	B	1290	A++	6.10	8.00	459
	15x25x35+50	0.96	1.60	2.24	3.20	3.03	8.00	9.45	0.68	2.52	3.47	3.0	11.2	15.4	98	3.17	B	1260	A++	6.10	8.00	460
	15x25x35+60	0.89	1.48	2.07	3.56	3.16	8.00	9.56	0.72	2.28	3.29	3.2	10.1	14.6	98	3.51	A	1140	A++	6.27	8.00	447
	15x25x42+42	0.97	1.61	2.71	2.71	3.01	8.00	9.44	0.67	2.58	3.61	3.0	11.4	16.0	98	3.10	B	1290	A++	6.15	8.00	456
	15x25x42+50	0.91	1.52	2.55	3.03	3.12	8.00	9.54	0.71	2.52	3.55	3.1	11.2	15.7	98	3.17	B	1260	A++	6.10	8.00	459
	15x25x42+60	0.85	1.41	2.37	3.38	3.26	8.00	9.58	0.72	2.28	3.29	3.2	10.1	14.6	98	3.51	A	1140	A++	6.27	8.00	447
	15x25x50+50	0.86	1.43	2.86	2.86	3.23	8.00	9.58	0.71	2.40	3.50	3.1	10.6	15.5	98	3.33	A	1200	A++	6.10	8.00	459
	15x35x35+35	1.00	2.33	2.33	2.33	2.96	8.00	9.37	0.67	2.58	3.45	3.0	11.4	15.3	98	3.10	B	1290	A+	6.04	8.00	464
	15x35x35+42	0.94	2.20	2.20	2.65	3.05	8.00	9.48	0.67	2.58	3.61	3.0	11.4	16.0	98	3.10	B	1290	A+	6.09	8.00	460
	15x35x35+50	0.89	2.07	2.07	2.96	3.16	8.00	9.56	0.71	2.52	3.55	3.1	11.2	15.7	98	3.17	B	1260	A+	6.08	8.00	461
	15x35x35+60	0.83	1.93	1.93	3.31	3.30	8.00	9.58	0.72	2.28	3.29	3.2	10.1	14.6	98	3.51	A	1140	A++	6.20	8.00	452
	15x35x42+42	0.90	2.09	2.51	2.51	3.15	8.00	9.55	0.71	2.58	3.69	3.1	11.4	16.4	98	3.10	B	1290	A++	6.10	8.00	460
	15x35x42+50	0.85	1.97	2.37	2.82	3.26	8.00	9.58	0.71	2.53	3.64	3.1	11.2	16.1	98	3.16	B	1265	A+	6.09	8.00	460
	15x42x42+42	0.85	2.38	2.38	2.38	3.25	8.00	9.58	0.75	2.58	3.69	3.3	11.4	16.4	98	3.10	B	1290	A++	6.10	8.00	460
	20x20x20+20	1.83	1.83	1.83	1.83	2.41	7.32	7.90	0.56	2.07	2.38	2.5	9.2	10.6	98	3.54	A	1035	A++	6.31	7.32	407
	20x20x20+25	1.75	1.75	1.75	2.18	2.48	7.42	8.16	0.56	2.13	2.51	2.5	9.4	11.1	98	3.48	A	1065	A++	6.31	7.42	412
	20x20x20+35	1.61	1.61	1.61	2.82	2.61	7.65	8.62	0.60	2.26	2.86	2.7	10.0	12.7	98	3.38	A	1130	A++	6.22	7.65	431
	20x20x20+42	1.53	1.53	1.53	3.22	2.71	7.82	8.89	0.64	2.32	3.00	2.8	10.3	13.3	98	3.37	A	1160	A++	6.22	7.82	441
20x20x20+50	1.45	1.45	1.45	3.64	2.82	8.00	9.15	0.64	2.52	3.32	2.8	11.2	14.7	98	3.17	B	1260	A++	6.18	8.00	454	
20x20x20+60	1.33	1.33	1.33	4.00	2.96	8.00	9.39	0.68	2.28	3.21	3.0	10.1	14.2	98	3.51	A	1140	A++	6.35	8.00	442	
20x20x20+71	1.22	1.22	1.22	4.34	3.11	8.00	9.55	0.68	2.22	3.29	3.0	9.8	14.6	98	3.60	A	1110	A++	6.35	8.00	442	
20x20x25+25	1.68	1.68	2.09	2.09	2.55	7.54	8.40	0.60	2.20	2.72	2.7	9.8	12.1	98	3.43	A	1100	A++	6.31	7.54	418	
20x20x25+35	1.55	1.55	1.94	2.72	2.68	7.77	8.82	0.60	2.45	3.14	2.7	10.9	13.9	98	3.17	B	1225	A++	6.25	7.77	436	
20x20x25+42	1.48	1.48	1.85	3.11	2.78	7.93	9.06	0.64	2.58	3.30	2.8	11.4	14.6	98	3.07	B	1290	A++	6.23	7.93	446	
20x20x25+50	1.39	1.39	1.74	3.48	2.89	8.00	9.28	0.64	2.52	3.39	2.8	11.2	15.0	98	3.17	B	1260	A++	6.24	8.00	449	
20x20x25+60	1.28	1.28	1.60	3.84	3.03	8.00	9.47	0.68	2.28	3.21	3.0	10.1	14.2	98	3.51	A	1140	A++	6.35	8.00	442	
20x20x25+71	1.18	1.18	1.47	4.18	3.18	8.00	9.59	0.72	2.22	3.29	3.2	9.8	14.6	98	3.60	A	1110	A++	6.35	8.00	442	
20x20x35+35	1.45	1.45	2.55	2.55	2.82	8.00	8.96	0.64	2.58	3.22	2.8	11.4	14.3	98	3.10	B	1290	A++	6.17	8.00	454	
20x20x35+42	1.37	1.37	2.39	2.87	2.92	8.00	9.32	0.67	2.58	3.53	3.0	11.4	15.7	98	3.10	B	1290	A++	6.17	8.00	454	
20x20x35+50	1.28	1.28	2.24	3.20	3.03	8.00	9.47	0.68	2.52	3.55	3.0	11.2	15.7	98	3.17	B	1260	A++	6.17	8.00	454	
20x20x35+60	1.19	1.19	2.07	3.56	3.16	8.00	9.58	0.72	2.28	3.29	3.2	10.1	14.6	98	3.51	A	1140	A++	6.27	8.00	447	
20x20x42+42	1.29	1.29	2.71	2.71	3.01	8.00	9.46	0.67	2.58	3.61	3.0	11.4	16.0	98	3.10	B	1290	A++	6.18	8.00	454	
20x20x42+50	1.21	1.21	2.55	3.03	3.12	8.00	9.56	0.71	2.52	3.55	3.1	11.2	15.7	98	3.17	B	1260	A++	6.17	8.00	454	
20x20x42+60	1.13	1.13	2.37	3.38	3.26	8.00	9.60	0.72	2.28	3.29	3.2	10.1	14.6	98	3.51	A	1140	A++	6.27	8.00	447	
20x20x50+50	1.14	1.14	2.86	2.86	3.23	8.00	9.60	0.71	2.44	3.50	3.1	10.8	15.5	98	3.28	A	1220	A++	6.17	8.00	454	
20x25x25+25	1.61	2.01	2.01	2.01	2.61	7.65	8.62	0.60	2.26	2.85	2.7	10.0	12.6	98	3.38	A	1130	A++	6.30	7.65	426	
20x25																						

Combination tables

Cooling

Outdoor unit	Indoor unit	Cooling capacity (kW)				Total capacity (kW)			Power input (kW)			Total current (A)			Power factor (%)	EER	Energy label	AEC (kWh)	Seasonal data			
		A room	B room	C room	D room	Min.	Nom.	Max.	Min.	Nom.	Max.	Min.	Nom.	Max.					Label	SEER	Pdesign	AEC
4MXS80E	25+25+35+35	1,48	1,48	2,07	2,96	3,16	8,00	9,58	0,71	2,52	3,63	3,1	11,2	16,1	98	3,17	B	1260	A++	6.18	8.00	454
	25+25+35+35+60	1,38	1,38	1,93	3,31	3,30	8,00	9,60	0,72	2,28	3,29	3,2	10,1	14,6	98	3,51	A	1140	A++	6.27	8.00	447
	25+25+42+42	1,49	1,49	2,51	2,51	3,15	8,00	9,57	0,71	2,58	3,69	3,1	11,4	16,4	98	3,10	B	1290	A++	6.18	8.00	454
	25+25+42+35	1,41	1,41	2,37	2,82	3,26	8,00	9,60	0,71	2,52	3,63	3,1	11,2	16,1	98	3,17	B	1260	A++	6.18	8.00	454
	25+35+35+35	1,54	2,15	2,15	2,15	3,09	8,00	9,35	0,71	2,58	3,30	3,1	11,4	14,6	98	3,10	B	1290	A++	6.11	8.00	459
	25+35+35+42	1,46	2,04	2,04	2,45	3,19	8,00	9,59	0,71	2,58	3,77	3,1	11,4	16,7	98	3,10	B	1290	A++	6.11	8.00	459
	25+35+35+35+50	1,38	1,93	1,93	2,76	3,30	8,00	9,60	0,75	2,52	3,63	3,3	11,2	16,1	98	3,17	B	1260	A++	6.11	8.00	459
	25+35+42+42	1,39	1,94	2,33	2,33	3,29	8,00	9,60	0,75	2,58	3,77	3,3	11,4	16,7	98	3,10	B	1290	A++	6.11	8.00	459
	35+35+35+35	2,00	2,00	2,00	2,00	3,23	8,00	9,60	0,71	2,58	3,77	3,1	11,4	16,7	98	3,10	B	1290	A+	6.04	8.00	464

- Notes:
- Cooling capacity is based on 27°CDB/19°CWB (Indoor temperature), 35°CDB (Outdoor temperature). Heating capacity is based on 20°CDB (Indoor temperature), 7°CDB/6°CWB (Outdoor temperature).
 - The total ability of connected indoor unit is up to 14.5kW.
 - It is impossible to connect the indoor unit for one room only.
 - The above is the value for connecting with the following indoor units.
 1.5kW: wall mounted CTXS-K series; 2.0, 2.5, 3.5, 4.2, 5.0kW: wall mounted FTXS-K series
 6.0, 7.1 kW class; wall mounted G series

Combination tables

Heating

Outdoor unit	Indoor unit	Heating capacity (kW)				Total capacity (kW)			Power input (kW)			Total current (A)			Power factor (%)	COP	Energy label	Seasonal data				
		A room	B room	C room	D room	Min.	Nom.	Max.	Min.	Nom.	Max.	Min.	Nom.	Max.				Label	SCOP	Pdesign	AEC	Back-up heater capacity at -10°C
4MXS80E	1.5+1.5	1.83	1.83	---	---	1.42	3.66	5.36	0.44	0.89	1.31	2.0	3.9	5.8	98	4.11	A	A	3.87	3.37	1219	0.64
	1.5+2.0	1.83	2.44	---	---	1.48	4.27	5.36	0.44	1.01	1.31	2.0	4.5	5.8	98	4.23	A	A	3.85	3.42	1243	0.62
	1.5+2.5	1.83	3.05	---	---	1.62	4.88	7.09	0.48	1.17	1.90	2.1	5.2	8.4	98	4.17	A	A	3.84	3.44	1255	0.64
	1.5+3.5	1.83	4.26	---	---	1.90	6.09	7.23	0.55	1.64	2.08	2.4	7.3	9.2	98	3.71	A	A	3.85	3.72	1353	0.71
	1.5+4.2	1.83	5.12	---	---	2.10	6.95	8.28	0.59	1.95	2.56	2.6	8.7	11.4	98	3.56	B	A	3.83	3.75	1372	0.67
	1.5+5.0	1.83	6.09	---	---	2.33	7.92	8.72	0.53	2.10	2.42	2.4	9.3	10.7	98	3.77	A	A	3.81	3.68	1354	0.67
	1.5+6.0	1.79	7.14	---	---	2.61	8.93	9.67	0.55	2.30	2.64	2.4	10.2	11.7	98	3.88	A	A	3.85	4.15	1508	0.80
	1.5+7.1	1.67	7.93	---	---	2.90	9.60	9.90	0.58	2.48	2.63	2.6	11.0	11.7	98	3.87	A	A	3.84	4.35	1588	0.80
	2.0+2.0	2.44	2.44	---	---	1.62	4.88	6.55	0.34	1.17	1.74	1.5	5.2	7.7	98	4.17	A	A	3.84	3.47	1266	0.67
	2.0+2.5	2.44	3.05	---	---	1.76	5.49	6.85	0.37	1.34	1.82	1.6	5.9	8.1	98	4.10	A	A	3.82	3.50	1282	0.63
	2.0+3.5	2.44	4.26	---	---	2.05	6.70	7.35	0.43	1.86	2.13	1.9	8.3	9.4	98	3.60	A	A	3.84	3.80	1386	0.72
	2.0+4.2	2.44	5.11	---	---	2.24	7.55	8.53	0.47	2.22	2.56	2.1	9.8	11.4	98	3.40	B	A	3.84	3.83	1397	0.75
	2.0+5.0	2.44	6.09	---	---	2.47	8.53	8.72	0.55	2.32	2.42	2.4	10.3	10.7	98	3.68	A	A	3.83	3.76	1374	0.68
	2.0+6.0	2.32	6.95	---	---	2.74	9.27	9.67	0.57	2.44	2.64	2.5	10.8	11.7	98	3.80	A	A	3.85	4.25	1548	0.83
	2.0+7.1	2.11	7.49	---	---	3.04	9.60	10.36	0.61	2.48	2.89	2.7	11.0	12.8	98	3.87	A	A	3.87	4.47	1619	0.85
	2.5+2.5	3.04	3.04	---	---	1.90	6.08	7.16	0.41	1.69	2.14	1.8	7.5	9.5	98	3.60	B	A	3.82	3.53	1293	0.66
	2.5+3.5	3.05	4.26	---	---	2.19	7.31	8.53	0.55	2.13	2.67	2.4	9.4	11.8	98	3.43	B	A	3.82	3.84	1407	0.69
	2.5+4.2	3.04	5.12	---	---	2.39	8.16	9.01	0.57	2.46	2.90	2.5	10.9	12.9	98	3.32	C	A	3.82	3.87	1417	0.72
	2.5+5.0	2.98	5.95	---	---	2.61	8.93	9.31	0.57	2.52	2.72	2.5	11.2	12.1	98	3.54	B	A	3.84	3.80	1386	0.72
	2.5+6.0	2.82	6.78	---	---	2.88	9.60	10.10	0.59	2.65	2.94	2.6	11.8	13.0	98	3.62	A	A	3.84	4.31	1571	0.82
	2.5+7.1	2.50	7.10	---	---	3.17	9.60	10.36	0.63	2.51	2.93	2.8	11.1	13.0	98	3.82	A	A	3.86	4.53	1642	0.84
	3.5+3.5	4.26	4.26	---	---	2.47	8.52	9.18	0.59	2.70	3.04	2.6	12.0	13.5	98	3.16	D	A	3.84	4.25	1551	0.83
	3.5+4.2	4.11	4.94	---	---	2.66	9.05	9.77	0.61	2.98	3.47	2.7	13.2	15.4	98	3.04	D	A	3.83	4.30	1572	0.81
	3.5+5.0	3.95	5.65	---	---	2.88	9.60	9.92	0.62	2.77	2.93	2.8	12.3	13.0	98	3.47	B	A	3.83	4.20	1535	0.78
	3.5+6.0	3.54	6.06	---	---	3.15	9.60	10.34	0.61	2.49	2.90	2.7	11.0	12.9	98	3.86	A	A	3.86	4.84	1756	0.89
	3.5+7.1	3.17	6.43	---	---	3.45	9.60	10.37	0.67	2.43	2.84	3.0	10.8	12.6	98	3.95	A	A	3.89	5.11	1841	0.97
	4.2+4.2	4.78	4.78	---	---	2.85	9.55	9.60	0.63	2.65	2.65	2.8	11.8	11.8	98	3.60	A	A	3.82	4.34	1591	0.79
	4.2+5.0	4.38	5.22	---	---	3.07	9.60	10.12	0.64	2.61	2.87	2.8	11.6	12.7	98	3.68	A	A	3.84	4.25	1551	0.83
	4.2+6.0	3.95	5.65	---	---	3.34	9.60	10.35	0.65	2.44	2.84	2.9	10.8	12.6	98	3.93	A	A	3.90	4.90	1762	0.95
	4.2+7.1	3.57	6.03	---	---	3.63	9.60	10.38	0.70	2.43	2.83	3.1	10.8	12.6	98	3.95	A	A	3.88	5.17	1865	0.96
	5.0+5.0	4.80	4.80	---	---	3.28	9.60	10.24	0.67	2.52	2.83	3.0	11.2	12.6	98	3.81	A	A	3.84	4.15	1512	0.80
	5.0+6.0	4.36	5.24	---	---	3.55	9.60	10.47	0.66	2.40	2.80	2.9	10.6	12.4	98	4.00	A	A	3.87	4.78	1728	0.89
	5.0+7.1	3.97	5.63	---	---	3.85	9.60	10.50	0.70	2.38	2.79	3.1	10.6	12.4	98	4.03	A	A	3.89	5.04	1816	0.96
	6.0+6.0	4.80	4.80	---	---	3.82	9.60	10.70	0.67	2.32	2.77	3.0	10.3	12.3	98	4.14	A	A	3.92	5.56	1987	1.04
	6.0+7.1	4.40	5.20	---	---	4.12	9.60	10.73	0.71	2.31	2.76	3.1	10.2	12.2	98	4.16	A	A	3.93	5.88	2097	1.12
	7.1+7.1	4.80	4.80	---	---	4.42	9.60	10.77	0.78	2.25	2.70	3.5	10.0	12.0	98	4.27	A	A	3.95	6.23	2208	1.18
	1.5+1.5+1.5	1.83	1.83	1.83	---	1.76	5.49	7.22	0.43	1.16	1.71	1.9	5.1	7.6	98	4.73	A	A	3.83	4.23	1547	0.81
	1.5+1.5+2.0	1.83	1.83	2.44	---	1.90	6.09	7.22	0.44	1.34	1.71	2.0	5.9	7.6	98	4.54	A	A	3.84	4.35	1585	0.80
	1.5+1.5+2.5	1.83	1.83	3.05	---	2.05	6.70	7.29	0.46	1.52	1.71	2.0	6.7	7.6	98	4.41	A	A	3.86	4.40	1598	0.84
	1.5+1.5+3.5	1.83	1.83	4.26	---	2.33	7.92	9.03	0.50	1.90	2.30	2.2	8.4	10.2	98	4.17	A	A	3.87	4.95	1789	0.94
	1.5+1.5+4.2	1.82	1.82	5.09	---	2.53	8.72	9.03	0.52	2.20	2.29	2.3	9.8	10.2	98	3.96	A	A	3.87	5.01	1811	0.93
	1.5+1.5+5.0	1.74	1.74	5.79	---	2.74	9.27	9.99	0.53	2.25	2.54	2.4	10.0	11.3	98	4.12	A	A	3.88	4.89	1766	0.94
	1.5+1.5+6.0	1.60	1.60	6.40	---	3.01	9.60	10.71	0.54	2.27	2.72	2.4	10.1	12.1	98	4.23	A	A	3.89	5.70	2052	1.06
	1.5+1.5+7.1	1.43	1.43	6.75	---	3.31	9.60	10.74	0.57	2.26	2.71	2.5	10.0	12.0	98	4.25	A	A	3.94	6.03	2145	1.15
	1.5+2.0+2.0	1.83	2.44	2.44	---	2.05	6.70	7.22	0.46	1.52	1.71	2.0	6.7	7.6	98	4.41	A	A	3.84	4.47	1630	0.85
	1.5+2.0+2.5	1.83	2.44	3.05	---	2.19	7.31	8.41	0.48	1.71	2.12	2.1	7.6	9.4	98	4.27	A	A	3.84	4.53	1654	0.84
	1.5+2.0+3.5	1.83	2.44	4.27	---	2.47	8.53	9.03	0.52	2.11	2.30	2.3	9.4	10.2	98	4.04	A	A	3.87	5.10	1846	0.96
	1.5+2.0+4.2	1.76	2.35	4.94	---	2.66	9.06	9.69	0.54	2.29	2.58	2.4	10.2	11.4	98	3.96	A	A	3.86	5.16	1871	0.95
	1.5+2.0+5.0	1.69	2.26	5.65	---	2.88	9.60	9.99	0.55	2.39	2.54	2.4	10.6	11.3	98	4.02	A	A	3.88	5.03	1817	0.95
	1.5+2.0+6.0	1.52	2.02	6.06	---	3.15	9.60	10.71	0.56	2.27	2.72	2.5	10.1	12.1	98	4.23	A	A	3.93	5.87	2094	1.11
1.5+2.0+7.1	1.36	1.81	6.43	---	3.45	9.60	10.74	0.60	2.26	2.71	2.7	10.0	12.0	98	4.25	A	A	3.93	6.22	2214	1.17	
1.5+2.5+2.5	1.83	3.05	3.05	---	2.33	7.92	8.93	0.50	1.94	2.30	2.2	8.6	10.2	98	4.08	A	A	3.83	4.59	1677	0.84	
1.5+2.5+3.5	1.79	2.98	4.17	---	2.61	8.93	9.68	0.54	2.25	2.58	2.4	10.0	11.4	98	3.97	A	A	3.87	5.18	1876	0.97	
1.5+2.5+4.2	1.72	2.87	4.82	---	2.80	9.41	9.69	0.56	2.43	2.58	2.5	10.8	11.4	98	3.87	A	A	3.89	5.24	1886	0.97	
1.5+2.5+5.0	1.60	2.67	5.33	---	3.01	9.60	10.48	0.57	2.39	2.80	2.5	10.6	12.4	98	4.02	A	A	3.87	5.11	1849	0.97	
1.5+2.5+6.0	1.44	2.40	5.76	---	3.28	9.60	10.71	0.58	2.27	2.72	2.6	10.1	12.1	98	4.23	A	A	3.94	5.96	2119	1.14	
1.5+2.5+7.1	1.30	2.16	6.14	---	3.58	9.60	10.74	0.62	2.26	2.71	2.8	10.0	12.0	98	4.25	A	A	3.94	6.23	2215	1.18	
1.5+3.5+3.5	1.69	3.95	3.95	---	2.88	9.60	9.89	0.59	2.43	2.58	2.6	10.8	11.4	98	3.95	A	A	3.92	5.87	2098	1.11	
1.5+3.5+4.2	1.57	3.65	4.38	---	3.07	9.60	10.36	0.61	2.43	2.84	2.7	10.8	12.6	98	3.95	A	A	3.92	5.94	2121	1.12	
1.5+3.5+5.0	1.44	3.36	4.80	---	3.28	9.60	10.49	0.61	2.39	2.79	2.7	10.6	12.4	98	4.02	A	A	3.91	5.79	2074	1.09	
1.5+3.5+6.0	1.31	3.05	5.24	---	3.55	9.60	10.72	0.62	2.27	2.72	2.8	10.1	12.1	98	4.23	A	A	3.97	6.23	2200	1.18	
1.5+3.5+7.1	1.19	2.78	5.63	---	3.85	9.60	10.75	0.66	2.26	2.70	2.9	10.0	12.0	98	4.25	A	A+	4.00	6.23	2181	1.17	
1.5+4.2+4.2	1.45	4.07	4.07	---	3.26	9.60	10.37	0.63	2.43	2.84	2.8	10.8	12.6	98								

Combination tables

Heating

Outdoor unit	Indoor unit	Heating capacity (kW)				Total capacity (kW)			Power input (kW)			Total current (A)			Power factor (%)	COP	Energy label	Seasonal data				
		A room	B room	C room	D room	Min.	Nom.	Max.	Min.	Nom.	Max.	Min.	Nom.	Max.				Label	SCOP	Pdesign	AEC	Back-up heater capacity at -10°C
4MXS0E	20+3.5+3.5	2.14	3.73	3.73	---	3.01	9.60	10.35	0.59	2.43	2.84	2.6	10.8	12.6	98	3.95	A	A	3.93	6.05	2155	1.17
	20+3.5+4.2	1.99	3.46	4.15	---	3.20	9.60	10.36	0.63	2.43	2.84	2.8	10.8	12.6	98	3.95	A	A	3.94	6.13	2179	1.20
	20+3.5+5.0	1.83	3.20	4.57	---	3.42	9.60	10.49	0.63	2.39	2.80	2.8	10.6	12.4	98	4.02	A	A	3.93	5.97	2126	1.15
	20+3.5+6.0	1.67	2.92	5.01	---	3.69	9.60	10.72	0.64	2.27	2.72	2.8	10.1	12.1	98	4.23	A	A+	4.00	6.23	2180	1.17
	20+3.5+7.1	1.52	2.67	5.41	---	3.99	9.60	10.75	0.69	2.26	2.70	3.1	10.0	12.0	98	4.25	A	A+	4.03	6.23	2166	1.17
	20+4.2+4.2	1.84	3.88	3.88	---	3.39	9.60	10.37	0.65	2.43	2.84	2.9	10.8	12.6	98	3.95	A	A	3.94	6.20	2205	1.21
	20+4.2+5.0	1.71	3.60	4.29	---	3.61	9.60	10.49	0.68	2.39	2.79	3.0	10.6	12.4	98	4.02	A	A	3.93	6.04	2152	1.16
	20+4.2+6.0	1.58	3.30	4.72	---	3.88	9.60	10.72	0.67	2.27	2.71	3.0	10.1	12.0	98	4.23	A	A+	4.00	6.23	2180	1.17
	20+4.2+7.1	1.45	3.03	5.12	---	4.18	9.60	10.76	0.73	2.26	2.70	3.2	10.0	12.0	98	4.25	A	A+	4.04	6.23	2161	1.17
	20+5.0+5.0	1.60	4.00	4.00	---	3.82	9.60	10.62	0.68	2.30	2.75	3.0	10.2	12.2	98	4.17	A	A	3.92	5.88	2100	1.12
	20+5.0+6.0	1.48	3.69	4.43	---	4.09	9.60	10.85	0.69	2.18	2.72	3.1	9.7	12.1	98	4.40	A	A	3.97	6.23	2198	1.18
	20+5.0+7.1	1.37	3.40	4.83	---	4.39	9.60	10.88	0.74	2.17	2.71	3.3	9.6	12.0	98	4.42	A	A+	4.00	6.23	2179	1.17
	20+6.0+6.0	1.38	4.11	4.11	---	4.36	9.60	11.08	0.70	2.11	2.64	3.1	9.4	11.7	98	4.55	A	A+	4.08	6.23	2141	1.17
	25+2.5+2.5	2.97	2.97	2.97	---	2.61	8.91	9.88	0.54	2.34	2.74	2.4	10.4	12.2	98	3.81	A	A	3.87	4.79	1736	0.90
	25+2.5+3.5	2.82	2.82	3.96	---	2.88	9.60	10.12	0.59	2.53	2.79	2.6	11.2	12.4	98	3.79	A	A	3.89	5.41	1949	1.02
	25+2.5+4.2	2.61	2.61	4.38	---	3.07	9.60	10.60	0.61	2.53	3.05	2.7	11.2	13.5	98	3.79	A	A	3.90	5.48	1965	1.02
	25+2.5+5.0	2.40	2.40	4.80	---	3.28	9.60	10.48	0.61	2.39	2.80	2.7	10.6	12.4	98	4.02	A	A	3.89	5.34	1925	1.01
	25+2.5+6.0	2.18	2.18	5.24	---	3.55	9.60	10.71	0.62	2.27	2.72	2.8	10.1	12.1	98	4.23	A	A	3.94	6.23	2217	1.18
	25+2.5+7.1	1.98	1.98	5.64	---	3.85	9.60	10.74	0.66	2.26	2.71	2.9	10.0	12.0	98	4.25	A	A	3.97	6.23	2197	1.18
	25+3.5+3.5	2.52	3.54	3.54	---	3.15	9.60	10.35	0.61	2.43	2.84	2.7	10.8	12.6	98	3.95	A	A	3.93	6.14	2189	1.15
	25+3.5+4.2	2.36	3.29	3.95	---	3.34	9.60	10.36	0.65	2.43	2.84	2.9	10.8	12.6	98	3.95	A	A	3.93	6.22	2217	1.17
	25+3.5+5.0	2.19	3.05	4.36	---	3.55	9.60	10.49	0.66	2.39	2.80	2.9	10.6	12.4	98	4.02	A	A	3.93	6.06	2157	1.18
	25+3.5+6.0	2.00	2.80	4.80	---	3.82	9.60	10.72	0.67	2.27	2.72	3.0	10.1	12.1	98	4.23	A	A+	4.01	6.23	2178	1.17
	25+3.5+7.1	1.84	2.56	5.20	---	4.12	9.60	10.75	0.71	2.26	2.70	3.1	10.0	12.0	98	4.25	A	A+	4.04	6.23	2161	1.17
	25+4.2+4.2	2.20	3.70	3.70	---	3.53	9.60	10.37	0.68	2.43	2.84	3.0	10.8	12.6	98	3.95	A	A	3.93	6.23	2219	1.18
	25+4.2+5.0	2.06	3.45	4.09	---	3.74	9.60	10.49	0.70	2.39	2.79	3.1	10.6	12.4	98	4.02	A	A	3.94	6.13	2179	1.20
	25+4.2+6.0	1.90	3.17	4.53	---	4.01	9.60	10.72	0.69	2.27	2.71	3.1	10.1	12.0	98	4.23	A	A+	4.00	6.23	2181	1.17
	25+4.2+7.1	1.75	2.92	4.93	---	4.31	9.60	10.76	0.76	2.26	2.70	3.4	10.0	12.0	98	4.25	A	A+	4.07	6.23	2146	1.17
	25+5.0+5.0	1.92	3.84	3.84	---	3.96	9.60	10.62	0.71	2.30	2.75	3.1	10.2	12.2	98	4.17	A	A	3.93	5.97	2126	1.15
	25+5.0+6.0	1.77	3.56	4.27	---	4.23	9.60	10.85	0.72	2.18	2.72	3.2	9.7	12.1	98	4.40	A	A+	4.00	6.23	2180	1.17
	25+6.0+6.0	1.66	3.97	3.97	---	4.50	9.60	11.08	0.72	2.11	2.64	3.2	9.4	11.7	98	4.55	A	A+	4.10	6.23	2125	1.16
	35+3.5+3.5	3.20	3.20	3.20	---	3.42	9.60	10.36	0.65	2.43	2.84	2.9	10.8	12.6	98	3.95	A	A	3.99	6.23	2184	1.17
	35+3.5+4.2	3.00	3.00	3.60	---	3.61	9.60	10.37	0.70	2.43	2.84	3.1	10.8	12.6	98	3.95	A	A+	4.00	6.23	2184	1.17
	35+3.5+5.0	2.80	2.80	4.00	---	3.82	9.60	10.49	0.70	2.39	2.79	3.1	10.6	12.4	98	4.02	A	A	3.96	6.23	2202	1.18
	35+3.5+6.0	2.58	2.58	4.44	---	4.09	9.60	10.72	0.71	2.27	2.71	3.1	10.1	12.0	98	4.23	A	A+	4.07	6.23	2144	1.17
	35+3.5+7.1	2.38	2.38	4.84	---	4.39	9.60	10.76	0.76	2.26	2.70	3.4	10.0	12.0	98	4.25	A	A+	4.11	6.22	2119	1.21
	35+4.2+4.2	2.82	3.39	3.39	---	3.80	9.60	10.38	0.72	2.43	2.83	3.2	10.8	12.6	98	3.95	A	A+	4.00	6.23	2182	1.17
	35+4.2+5.0	2.65	3.17	3.78	---	4.01	9.60	10.50	0.75	2.39	2.79	3.3	10.6	12.4	98	4.02	A	A	3.99	6.23	2189	1.17
	35+4.2+6.0	2.45	2.94	4.21	---	4.28	9.60	10.73	0.74	2.26	2.71	3.3	10.0	12.0	98	4.25	A	A+	4.07	6.23	2143	1.16
	35+5.0+5.0	2.48	3.56	3.56	---	4.23	9.60	10.63	0.76	2.30	2.75	3.4	10.2	12.2	98	4.17	A	A	3.96	6.23	2203	1.18
	35+5.0+6.0	2.32	3.31	3.97	---	4.50	9.60	10.86	0.77	2.18	2.72	3.4	9.7	12.1	98	4.40	A	A+	4.06	6.23	2149	1.17
	42+2.4+4.2	3.20	3.20	3.20	---	3.99	9.60	10.38	0.75	2.42	2.83	3.3	10.7	12.6	98	3.97	A	A+	4.00	6.23	2183	1.17
	42+4.2+5.0	3.01	3.01	3.58	---	4.20	9.60	10.51	0.78	2.38	2.79	3.5	10.6	12.4	98	4.03	A	A+	4.00	6.23	2184	1.17
	42+4.2+6.0	2.80	2.80	4.00	---	4.47	9.60	10.74	0.79	2.26	2.71	3.5	10.0	12.0	98	4.25	A	A+	4.10	6.23	2129	1.16
	42+5.0+5.0	2.84	3.38	3.38	---	4.42	9.60	10.64	0.81	2.29	2.74	3.6	10.2	12.2	98	4.19	A	A	3.96	6.23	2202	1.18
	15+1.5+1.5+1.5	1.83	1.83	1.83	1.83	2.19	7.31	8.47	0.41	1.64	2.00	1.8	7.3	8.9	98	4.46	A	A	3.92	5.84	2085	1.14
	15+1.5+1.5+2.0	1.83	1.83	1.83	2.44	2.33	7.92	9.04	0.42	1.83	2.22	1.9	8.1	9.8	98	4.33	A	A	3.92	6.02	2149	1.14
	15+1.5+1.5+2.5	1.83	1.83	1.83	3.05	2.47	8.53	9.13	0.44	2.00	2.22	2.0	8.9	9.8	98	4.27	A	A	3.93	6.11	2176	1.18
	15+1.5+1.5+3.5	1.74	1.74	1.74	4.06	2.74	9.27	10.18	0.48	2.17	2.51	2.1	9.6	11.1	98	4.27	A	A+	4.00	6.23	2194	1.17
	15+1.5+1.5+4.2	1.66	1.66	1.66	4.63	2.93	9.60	10.73	0.51	2.26	2.71	2.3	10.0	12.0	98	4.25	A	A	3.99	6.23	2185	1.17
15+1.5+1.5+5.0	1.52	1.52	1.52	5.05	3.15	9.60	10.86	0.52	2.18	2.72	2.3	9.7	12.1	98	4.40	A	A	3.97	6.23	2195	1.18	
15+1.5+1.5+6.0	1.37	1.37	1.37	5.49	3.42	9.60	11.09	0.52	2.10	2.64	2.3	9.3	11.7	98	4.57	A	A+	4.09	6.23	2135	1.17	
15+1.5+1.5+7.1	1.24	1.24	1.24	5.88	3.72	9.60	11.12	0.56	2.09	2.63	2.5	9.3	11.7	98	4.59	A	A+	4.13	6.22	2109	1.21	
15+1.5+2.0+2.0	1.83	1.83	2.44	2.44	2.47	8.53	9.04	0.44	2.04	2.22	2.0	9.1	9.8	98	4.18	A	A	3.95	6.20	2198	1.21	
15+1.5+2.0+2.5	1.79	1.79	2.38	2.98	2.61	8.93	9.87	0.46	2.13	2.51	2.0	9.4	11.1	98	4.19	A	A	3.95	6.23	2211	1.18	
15+1.5+2.0+3.5	1.69	1.69	2.26	3.95	2.88	9.60	10.18	0.52	2.27	2.51	2.3	10.1	11.1	98	4.23	A	A+	4.02	6.23	2172	1.17	
15+1.5+2.0+4.2	1.57	1.57	2.09	4.38	3.07	9.60	10.73	0.53	2.26	2.71	2.4	10.0	12.0	98	4.25	A	A+	4.02	6.23	2170	1.17	
15+1.5+2.0+5.0	1.44	1.44	1.92	4.80	3.28	9.60	10.86	0.54	2.18	2.72	2.4	9.7	12.1	98	4.40	A	A+	4.02	6.23	2172	1.17	
15+1.5+2.0+6.0	1.31	1.31	1.75	5.24	3.55	9.60	11.09	0.54	2.10	2.64	2.4	9.3	11.7	98	4.57	A	A+	4.11	6.23	2121	1.16	
15+1.5+2.0+7.1	1.19	1.19	1.59	5.63	3.85	9.60	11.12	0.58	2.09	2.63	2.6	9.3	11.7	98	4.59	A	A+	4.14	6.22	2102	1.21	
15+1.5+2.5+2.5	1.74	1.74	2.90	2.90	2.74	9.27	10.17	0.48	2.18	2.51	2.1	9.7	11.1									

Combination tables

Heating

Outdoor unit	Indoor unit	Heating capacity (kW)				Total capacity (kW)			Power input (kW)			Total current (A)			Power factor (%)	COP	Energy label	Seasonal data				
		A room	B room	C room	D room	Min.	Nom.	Max.	Min.	Nom.	Max.	Min.	Nom.	Max.				Label	SCOP	Pdesign	AEC	Back-up heater capacity at -10°C
4MXS80E	15x20x20x71	1.14	1.52	1.52	5.41	3.99	9.60	11.12	0.62	2.09	2.63	2.8	9.3	11.7	98	4.59	A	A+	4.17	6.22	2089	1.20
	15x20x25x25	1.69	2.26	2.82	2.82	2.88	9.60	10.17	0.52	2.27	2.51	2.3	10.1	11.1	98	4.23	A	A	3.98	6.23	2194	1.18
	15x20x25x35	1.52	2.02	2.53	3.54	3.15	9.60	10.72	0.56	2.27	2.71	2.5	10.1	12.0	98	4.23	A	A+	4.03	6.23	2166	1.17
	15x20x25x42	1.41	1.88	2.35	3.95	3.34	9.60	10.73	0.58	2.26	2.71	2.6	10.0	12.0	98	4.25	A	A+	4.03	6.23	2165	1.17
	15x20x25x50	1.31	1.75	2.18	4.36	3.55	9.60	10.86	0.60	2.18	2.72	2.7	9.7	12.1	98	4.40	A	A+	4.02	6.23	2168	1.17
	15x20x25x60	1.20	1.60	2.00	4.80	3.82	9.60	11.09	0.59	2.10	2.64	2.6	9.3	11.7	98	4.57	A	A+	4.14	6.22	2104	1.21
	15x20x25x71	1.10	1.47	1.83	5.20	4.12	9.60	11.12	0.65	2.09	2.63	2.9	9.3	11.7	98	4.59	A	A+	4.20	6.22	2074	1.20
	15x20x35x35	1.37	1.83	3.20	3.20	3.42	9.60	10.73	0.60	2.26	2.71	2.7	10.0	12.0	98	4.25	A	A+	4.12	6.22	2113	1.21
	15x20x35x42	1.29	1.71	3.00	3.60	3.61	9.60	10.74	0.62	2.26	2.71	2.8	10.0	12.0	98	4.25	A	A+	4.13	6.22	2108	1.21
	15x20x35x50	1.20	1.60	2.80	4.00	3.82	9.60	10.86	0.64	2.17	2.71	2.8	9.6	12.0	98	4.42	A	A+	4.12	6.22	2113	1.21
	15x20x35x60	1.11	1.48	2.58	4.43	4.09	9.60	11.09	0.65	2.10	2.63	2.9	9.3	11.7	98	4.57	A	A+	4.22	6.22	2065	1.20
	15x20x35x71	1.02	1.36	2.38	4.83	4.39	9.60	11.13	0.69	2.09	2.62	3.1	9.3	11.6	98	4.59	A	A+	4.26	6.22	2047	1.19
	15x20x42x42	1.21	1.61	3.39	3.39	3.80	9.60	10.75	0.66	2.26	2.70	2.9	10.0	12.0	98	4.25	A	A+	4.14	6.22	2106	1.21
	15x20x42x50	1.13	1.51	3.17	3.78	4.01	9.60	10.87	0.67	2.17	2.71	3.0	9.6	12.0	98	4.42	A	A+	4.12	6.22	2113	1.21
	15x20x42x60	1.05	1.40	2.94	4.20	4.28	9.60	11.10	0.67	2.10	2.63	3.0	9.3	11.7	98	4.57	A	A+	4.21	6.22	2067	1.20
	15x20x50x50	1.07	1.42	3.56	3.56	4.23	9.60	11.00	0.69	2.13	2.67	3.1	9.4	11.8	98	4.51	A	A+	4.11	6.23	2125	1.16
	15x20x50x60	0.99	1.32	3.31	3.97	4.50	9.60	11.23	0.70	2.01	2.59	3.1	8.9	11.5	98	4.78	A	A+	4.21	6.22	2067	1.20
	15x25x25x25	1.60	2.67	2.67	2.67	3.01	9.60	10.71	0.54	2.27	2.72	2.4	10.1	12.1	98	4.23	A	A	3.98	6.23	2192	1.18
	15x25x25x35	1.44	2.40	2.40	3.36	3.28	9.60	10.72	0.58	2.27	2.71	2.6	10.1	12.0	98	4.23	A	A+	4.03	6.23	2165	1.17
	15x25x25x42	1.35	2.24	2.24	3.77	3.47	9.60	10.73	0.60	2.26	2.71	2.7	10.0	12.0	98	4.25	A	A+	4.07	6.23	2142	1.17
	15x25x25x50	1.25	2.09	2.09	4.17	3.69	9.60	10.86	0.62	2.18	2.72	2.8	9.7	12.1	98	4.40	A	A+	4.03	6.23	2167	1.17
	15x25x25x60	1.15	1.92	1.92	4.61	3.96	9.60	11.09	0.61	2.10	2.64	2.7	9.3	11.7	98	4.57	A	A+	4.14	6.22	2102	1.20
	15x25x25x71	1.06	1.76	1.76	5.01	4.26	9.60	11.12	0.67	2.09	2.63	3.0	9.3	11.7	98	4.59	A	A+	4.20	6.22	2074	1.20
	15x25x35x35	1.31	2.18	3.05	3.05	3.55	9.60	10.73	0.62	2.26	2.71	2.8	10.0	12.0	98	4.25	A	A+	4.13	6.22	2108	1.21
	15x25x35x42	1.23	2.05	2.87	3.45	3.74	9.60	10.74	0.64	2.26	2.71	2.8	10.0	12.0	98	4.25	A	A+	4.14	6.22	2106	1.21
	15x25x35x50	1.15	1.92	2.69	3.84	3.96	9.60	10.86	0.67	2.17	2.71	3.0	9.6	12.0	98	4.42	A	A+	4.13	6.22	2111	1.21
	15x25x35x60	1.07	1.78	2.49	4.27	4.23	9.60	11.09	0.67	2.10	2.63	3.0	9.3	11.7	98	4.57	A	A+	4.21	6.22	2067	1.20
	15x25x42x42	1.16	1.94	3.25	3.25	3.93	9.60	10.75	0.69	2.26	2.70	3.1	10.0	12.0	98	4.25	A	A+	4.13	6.22	2107	1.20
	15x25x42x50	1.09	1.82	3.05	3.64	4.15	9.60	10.87	0.69	2.17	2.71	3.1	9.6	12.0	98	4.42	A	A+	4.13	6.22	2108	1.21
	15x25x42x60	1.01	1.69	2.84	4.06	4.42	9.60	11.10	0.70	2.10	2.63	3.1	9.3	11.7	98	4.57	A	A+	4.22	6.22	2062	1.20
	15x25x50x50	1.03	1.71	3.43	3.43	4.36	9.60	11.00	0.71	2.13	2.67	3.1	9.4	11.8	98	4.51	A	A+	4.12	6.22	2113	1.21
	15x35x35x35	1.20	2.80	2.80	2.80	3.82	9.60	10.74	0.66	2.26	2.71	2.9	10.0	12.0	98	4.25	A	A+	4.21	6.22	2069	1.20
	15x35x35x42	1.13	2.65	2.65	3.17	4.01	9.60	10.75	0.69	2.26	2.70	3.1	10.0	12.0	98	4.25	A	A+	4.21	6.22	2071	1.20
	15x35x35x50	1.07	2.49	2.49	3.56	4.23	9.60	10.87	0.71	2.17	2.71	3.1	9.6	12.0	98	4.42	A	A+	4.21	6.22	2071	1.20
	15x35x35x60	0.99	2.32	2.32	3.97	4.50	9.60	11.10	0.72	2.10	2.63	3.2	9.3	11.7	98	4.57	A	A+	4.28	6.22	2036	1.19
	15x35x42x42	1.07	2.51	3.01	3.01	4.20	9.60	10.75	0.73	2.26	2.70	3.2	10.0	12.0	98	4.25	A	A+	4.21	6.22	2071	1.20
	15x35x42x50	1.01	2.37	2.84	3.38	4.42	9.60	10.88	0.74	2.17	2.71	3.3	9.6	12.0	98	4.42	A	A+	4.21	6.22	2071	1.20
	15x42x42x42	1.02	2.86	2.86	2.86	4.39	9.60	10.76	0.76	2.25	2.70	3.4	10.0	12.0	98	4.27	A	A+	4.22	6.22	2066	1.19
	20x20x20x20	2.32	2.32	2.32	2.32	2.74	9.28	9.78	0.48	2.27	2.51	2.1	10.1	11.1	98	4.09	A	A	3.98	6.23	2194	1.18
	20x20x20x25	2.26	2.26	2.26	2.82	2.88	9.60	9.92	0.52	2.36	2.51	2.3	10.5	11.1	98	4.07	A	A	3.98	6.23	2192	1.18
	20x20x20x35	2.02	2.02	2.02	3.54	3.15	9.60	10.72	0.56	2.27	2.71	2.5	10.1	12.0	98	4.23	A	A+	4.05	6.23	2152	1.17
	20x20x20x42	1.88	1.88	1.88	3.96	3.34	9.60	10.73	0.58	2.26	2.71	2.6	10.0	12.0	98	4.25	A	A+	4.07	6.23	2142	1.17
	20x20x20x50	1.75	1.75	1.75	4.35	3.55	9.60	10.86	0.60	2.18	2.72	2.7	9.7	12.1	98	4.40	A	A+	4.03	6.23	2167	1.17
	20x20x20x60	1.60	1.60	1.60	4.80	3.82	9.60	11.09	0.59	2.10	2.64	2.6	9.3	11.7	98	4.57	A	A+	4.14	6.22	2102	1.20
	20x20x20x71	1.47	1.47	1.47	5.19	4.12	9.60	11.12	0.65	2.09	2.63	2.9	9.3	11.7	98	4.59	A	A+	4.20	6.22	2074	1.20
	20x20x25x25	2.13	2.13	2.67	2.67	3.01	9.60	10.71	0.54	2.27	2.72	2.4	10.1	12.1	98	4.23	A	A	3.98	6.23	2191	1.18
	20x20x25x35	1.92	1.92	2.40	3.36	3.28	9.60	10.72	0.58	2.27	2.71	2.6	10.1	12.0	98	4.23	A	A+	4.08	6.23	2140	1.17
	20x20x25x42	1.79	1.79	2.25	3.77	3.47	9.60	10.73	0.60	2.26	2.71	2.7	10.0	12.0	98	4.25	A	A+	4.08	6.23	2140	1.17
	20x20x25x50	1.67	1.67	2.09	4.17	3.69	9.60	10.86	0.62	2.18	2.72	2.8	9.7	12.1	98	4.40	A	A+	4.05	6.23	2152	1.17
	20x20x25x60	1.54	1.54	1.92	4.60	3.96	9.60	11.09	0.61	2.10	2.64	2.7	9.3	11.7	98	4.57	A	A+	4.14	6.22	2102	1.20
20x20x25x71	1.41	1.41	1.76	5.02	4.26	9.60	11.12	0.67	2.09	2.63	3.0	9.3	11.7	98	4.59	A	A+	4.20	6.22	2072	1.20	
20x25x35x35	1.75	1.75	3.05	3.05	3.55	9.60	10.73	0.62	2.26	2.71	2.8	10.0	12.0	98	4.25	A	A+	4.14	6.22	2106	1.20	
20x25x35x42	1.64	1.64	2.87	3.45	3.74	9.60	10.74	0.64	2.26	2.71	2.8	10.0	12.0	98	4.25	A	A+	4.13	6.22	2107	1.20	
20x25x35x50	1.54	1.54	2.69	3.83	3.96	9.60	10.86	0.67	2.17	2.71	3.0	9.6	12.0	98	4.42	A	A+	4.13	6.22	2108	1.21	
20x25x35x60	1.42	1.42	2.49	4.27	4.23	9.60	11.09	0.67	2.10	2.63	3.0	9.3	11.7	98	4.57	A	A+	4.22	6.22	2062	1.20	
20x20x42x42	1.55	1.55	3.25	3.25	3.93	9.60	10.75	0.66	2.26	2.70	2.9	10.0	12.0	98	4.25	A	A+	4.16	6.22	2092	1.20	
20x20x42x50	1.45	1.45	3.06	3.64	4.15	9.60	10.87	0.69	2.17	2.71	3.1	9.6	12.0	98	4.42	A	A+	4.14	6.22	2106	1.21	
20x20x42x60	1.35	1.35	2.84	4.06	4.42	9.60	11.10	0.70	2.10	2.63	3.1	9.3	11.7	98	4.57	A	A+	4.22	6.22	2062	1.19	
20x25x50x50	1.37	1.37	3.43	3.43	4.36	9.60	11.00	0.72	2.13	2.67	3.2	9.4	11.8	98	4.51	A	A+	4.13	6.22	2111	1.21	
20x25x25x25	2.01	2.53	2.53	2.53	3.15	9.60	10.71	0.56	2.27	2.72	2.5	10.1	12.1	98	4.23	A	A	3.				

Combination tables

Heating

Outdoor unit	Indoor unit	Heating capacity (kW)				Total capacity (kW)			Power input (kW)			Total current (A)			Power factor (%)	COP	Energy label	Seasonal data				
		A room	B room	C room	D room	Min.	Nom.	Max.	Min.	Nom.	Max.	Min.	Nom.	Max.				Label	SCOP	Pdesign	AEC	Back-up heater capacity at -10°C
4MXS80E	25+25+35+35	1.78	1.78	2.49	3.55	4.23	9.60	10.86	0.71	2.18	2.71	3.1	9.7	12.0	98	4.40	A	A+	4.14	6.22	2105	1.20
	25+25+35+60	1.66	1.66	2.32	3.96	4.50	9.60	11.09	0.72	2.10	2.63	3.2	9.3	11.7	98	4.57	A	A+	4.26	6.22	2047	1.19
	25+25+42+42	1.79	1.79	3.01	3.01	4.20	9.60	10.75	0.71	2.26	2.70	3.1	10.0	12.0	98	4.25	A	A+	4.19	6.22	2078	1.20
	25+25+42+50	1.69	1.69	2.85	3.37	4.42	9.60	10.87	0.76	2.17	2.71	3.4	9.6	12.0	98	4.42	A	A+	4.16	6.22	2092	1.20
	25+35+35+35	1.86	2.58	2.58	2.58	4.09	9.60	10.74	0.71	2.26	2.71	3.1	10.0	12.0	98	4.25	A	A+	4.22	6.22	2066	1.19
	25+35+35+42	1.76	2.45	2.45	2.94	4.28	9.60	10.75	0.74	2.26	2.70	3.3	10.0	12.0	98	4.25	A	A+	4.25	6.22	2051	1.19
	25+35+35+50	1.65	2.32	2.32	3.31	4.50	9.60	10.87	0.76	2.17	2.71	3.4	9.6	12.0	98	4.42	A	A+	4.22	6.22	2066	1.20
	25+35+42+42	1.67	2.33	2.80	2.80	4.47	9.60	10.75	0.78	2.26	2.70	3.5	10.0	12.0	98	4.25	A	A+	4.25	6.22	2051	1.19
	35+35+35+35	2.40	2.40	2.40	2.40	4.36	9.60	10.75	0.76	2.26	2.70	3.4	10.0	12.0	98	4.25	A	A+	4.31	6.22	2021	1.19

- Notes:
- Cooling capacity is based on 27°CDB/19°CWB (Indoor temperature), 35°CDB (Outdoor temperature). Heating capacity is based on 20°CDB (Indoor temperature), 7°CDB/6°CWB (Outdoor temperature).
 - The total ability of connected indoor unit is up to 14.5kW.
 - It is impossible to connect the indoor unit for one room only.
 - The above is the value for connecting with the following indoor units.
1.5kW: wall mounted CTXS-K series; 2.0, 2.5, 3.5, 4.2, 5.0kW: wall mounted FTXS-K series
6.0, 7.1 kW class; wall mounted G series

Combination tables

Cooling

Outdoor unit	Indoor unit	Cooling capacity (kW)					Total capacity (kW)			Power input (kW)			Total current (A)			Power factor (%)	EER	Energy label	AEC (kWh)	Seasonal data			
		A room	B room	C room	D room	E room	Min.	Nom.	Max.	Min.	Nom.	Max.	Min.	Nom.	Max.					Label	SEER	Pdesign	AEC
5MXS90E	1.5+1.5	1.50	1.50	---	---	---	2.03	3.00	4.03	0.46	0.78	1.14	2.0	3.5	5.1	98	3.85	A	390	A	5.26	3.00	200
	1.5+2.0	1.50	2.00	---	---	---	2.05	3.50	4.50	0.50	0.94	1.34	2.2	4.2	5.9	98	3.72	A	470	A	5.49	3.50	224
	1.5+2.5	1.50	2.50	---	---	---	2.11	4.00	4.96	0.46	1.06	1.38	2.0	4.7	6.1	98	3.77	A	530	A+	5.66	4.00	248
	1.5+3.5	1.50	3.50	---	---	---	2.22	5.00	5.82	0.46	1.43	1.79	2.0	6.3	7.9	98	3.50	A	715	A+	5.67	5.00	309
	1.5+4.2	1.50	4.20	---	---	---	2.29	5.70	6.37	0.46	1.75	2.09	2.0	7.8	9.3	98	3.26	A	875	A+	5.74	5.70	348
	1.5+5.0	1.50	5.00	---	---	---	2.38	6.50	6.97	0.50	2.10	2.42	2.2	9.3	10.7	98	3.10	B	1050	A+	5.74	6.50	397
	1.5+6.0	1.45	5.79	---	---	---	2.51	7.24	7.64	0.54	2.34	2.57	2.4	10.4	11.4	98	3.09	B	1170	A++	6.14	7.24	413
	1.5+7.1	1.33	6.30	---	---	---	2.67	7.63	8.29	0.57	2.57	3.00	2.5	11.4	13.3	98	2.97	C	1285	A+	6.08	7.63	439
	2.0+2.0	2.00	2.00	---	---	---	2.11	4.00	5.30	0.50	1.14	1.79	2.2	5.1	7.9	98	3.51	A	570	A+	5.68	4.00	247
	2.0+2.5	2.00	2.50	---	---	---	2.16	4.50	5.73	0.50	1.30	1.79	2.2	5.8	7.9	98	3.46	A	650	A+	5.80	4.50	272
	2.0+3.5	2.00	3.50	---	---	---	2.27	5.50	6.36	0.50	1.70	2.09	2.2	7.5	9.3	98	3.24	A	850	A+	5.77	5.50	334
	2.0+4.2	2.00	4.20	---	---	---	2.35	6.20	6.75	0.50	1.99	2.35	2.2	8.8	10.4	98	3.12	B	995	A+	5.86	6.20	371
	2.0+5.0	2.00	5.00	---	---	---	2.44	7.00	7.31	0.50	2.42	2.59	2.2	10.7	11.5	98	2.89	C	1210	A+	5.71	7.00	430
	2.0+6.0	1.86	5.56	---	---	---	2.58	7.42	7.96	0.54	2.45	2.81	2.4	10.9	12.5	98	3.03	B	1225	A++	6.10	7.42	426
	2.0+7.1	1.71	6.09	---	---	---	2.74	7.80	8.47	0.57	2.69	3.13	2.5	11.9	13.9	98	2.90	C	1345	A++	6.10	7.80	448
	2.5+2.5	2.50	2.50	---	---	---	2.22	5.00	6.20	0.46	1.39	1.99	2.0	6.2	8.8	98	3.60	A	695	A+	5.84	5.00	300
	2.5+3.5	2.50	3.50	---	---	---	2.33	6.00	6.60	0.50	1.89	2.25	2.2	8.4	10.0	98	3.17	B	945	A+	6.01	6.00	350
	2.5+4.2	2.50	4.20	---	---	---	2.41	6.70	7.11	0.50	2.30	2.57	2.2	10.2	11.4	98	2.91	C	1150	A+	5.82	6.70	404
	2.5+5.0	2.41	4.83	---	---	---	2.51	7.24	7.64	0.53	2.59	2.82	2.4	11.5	12.5	98	2.80	D	1295	A+	5.68	7.24	447
	2.5+6.0	2.23	5.36	---	---	---	2.66	7.59	8.25	0.57	2.57	3.00	2.5	11.4	13.3	98	2.95	C	1285	A++	6.12	7.59	435
	2.5+7.1	2.08	5.90	---	---	---	2.82	7.98	8.47	0.60	2.81	3.13	2.7	12.5	13.9	98	2.84	C	1405	A++	6.10	7.98	458
	3.5+3.5	3.50	3.50	---	---	---	2.44	7.00	7.31	0.53	2.52	2.69	2.4	11.2	11.9	98	2.78	D	1260	A+	5.67	7.00	433
	3.5+4.2	3.32	3.99	---	---	---	2.54	7.31	7.66	0.53	2.69	2.92	2.4	11.9	13.0	98	2.72	D	1345	A+	5.62	7.39	460
	3.5+5.0	3.13	4.46	---	---	---	2.66	7.59	7.83	0.57	2.82	2.94	2.5	12.5	13.0	98	2.69	D	1410	A	5.58	7.59	476
	3.5+6.0	2.93	5.01	---	---	---	2.80	7.94	8.45	0.60	2.81	3.13	2.7	12.5	13.9	98	2.83	C	1405	A+	6.03	7.94	461
	3.5+7.1	2.75	5.58	---	---	---	2.96	8.33	8.47	0.64	3.07	3.13	2.8	13.6	13.9	98	2.71	D	1535	A+	6.00	8.33	487
	4.2+4.2	3.78	3.78	---	---	---	2.64	7.56	7.67	0.56	2.86	2.92	2.5	12.7	13.0	98	2.64	D	1430	A+	5.66	7.40	458
	4.2+5.0	3.58	4.26	---	---	---	2.76	7.84	8.01	0.60	2.94	3.07	2.7	13.0	13.6	98	2.67	D	1470	A	5.56	7.70	485
	4.2+6.0	3.37	4.82	---	---	---	2.91	8.19	8.46	0.60	2.94	3.13	2.7	13.0	13.9	98	2.79	D	1470	A+	5.98	8.19	480
	4.2+7.1	3.19	5.39	---	---	---	3.07	8.58	8.66	0.64	3.26	3.26	2.8	14.5	14.5	98	2.63	D	1630	A+	6.01	8.34	486
	5.0+5.0	4.06	4.06	---	---	---	2.88	8.12	8.18	0.60	3.09	3.19	2.7	13.7	14.2	98	2.63	D	1545	A	5.55	8.12	513
	5.0+6.0	3.85	4.62	---	---	---	3.02	8.47	8.64	0.64	3.09	3.25	2.8	13.7	14.4	98	2.74	D	1545	A+	5.91	8.47	502
	5.0+7.1	3.66	5.20	---	---	---	3.19	8.86	8.88	0.67	3.36	3.39	3.0	14.9	15.0	98	2.64	D	1680	A+	5.90	8.86	526
	6.0+6.0	4.41	4.41	---	---	---	3.17	8.82	9.27	0.64	3.08	3.36	2.8	13.7	14.9	98	2.86	C	1540	A++	6.22	8.82	497
	6.0+7.1	4.12	4.88	---	---	---	3.33	9.00	9.29	0.68	3.08	3.36	3.0	13.7	14.9	98	2.92	C	1540	A++	6.21	9.00	508
	7.1+7.1	4.50	4.50	---	---	---	3.49	9.00	9.31	0.71	3.02	3.36	3.1	13.4	14.9	98	2.98	C	1510	A++	6.23	9.00	506
	1.5+1.5+1.5	1.50	1.50	1.50	---	---	2.16	4.50	5.40	0.47	1.05	1.39	2.1	4.7	6.2	98	4.29	A	525	A+	5.88	4.50	268
	1.5+1.5+2.0	1.50	1.50	2.00	---	---	2.22	5.00	5.82	0.47	1.22	1.57	2.1	5.4	7.0	98	4.10	A	610	A+	6.02	5.00	291
	1.5+1.5+2.5	1.50	1.50	2.50	---	---	2.27	5.50	6.22	0.47	1.43	1.76	2.1	6.3	7.8	98	3.85	A	715	A+	6.09	5.50	317
	1.5+1.5+3.5	1.50	1.50	3.50	---	---	2.38	6.50	6.97	0.50	1.91	2.17	2.2	8.5	9.6	98	3.40	A	955	A++	6.12	6.50	372
	1.5+1.5+4.2	1.49	1.49	4.17	---	---	2.46	7.14	7.45	0.50	2.28	2.45	2.2	10.1	10.9	98	3.13	B	1140	A+	6.06	7.14	413
	1.5+1.5+5.0	1.39	1.39	4.64	---	---	2.58	7.42	7.96	0.54	2.35	2.71	2.4	10.4	12.0	98	3.16	B	1175	A+	6.04	7.42	430
1.5+1.5+6.0	1.30	1.30	5.18	---	---	2.73	7.77	8.53	0.58	2.38	2.82	2.6	10.6	12.5	98	3.26	A	1190	A++	6.32	7.77	430	
1.5+1.5+7.1	1.21	1.21	5.74	---	---	2.89	8.16	9.07	0.61	2.56	3.22	2.7	11.4	14.3	98	3.19	B	1280	A++	6.32	8.16	452	
1.5+2.0+2.0	1.50	2.00	2.00	---	---	2.27	5.50	6.22	0.50	1.43	1.76	2.2	6.3	7.8	98	3.85	A	715	A++	6.13	5.50	315	
1.5+2.0+2.5	1.50	2.00	2.50	---	---	2.33	6.00	6.60	0.47	1.66	1.96	2.1	7.4	8.7	98	3.61	A	830	A++	6.17	6.00	341	
1.5+2.0+3.5	1.50	2.00	3.50	---	---	2.44	7.00	7.31	0.50	2.17	2.40	2.2	9.6	10.6	98	3.23	A	1085	A++	6.14	7.00	399	
1.5+2.0+4.2	1.42	1.90	3.99	---	---	2.54	7.31	7.77	0.54	2.40	2.69	2.4	10.6	11.9	98	3.05	B	1200	A++	6.11	7.31	419	
1.5+2.0+5.0	1.34	1.79	4.46	---	---	2.66	7.59	8.25	0.54	2.47	2.89	2.4	11.0	12.8	98	3.07	B	1225	A+	6.08	7.59	437	
1.5+2.0+6.0	1.25	1.67	5.01	---	---	2.80	7.94	8.78	0.58	2.44	3.01	2.6	10.8	13.4	98	3.25	A	1230	A++	6.32	7.94	440	
1.5+2.0+7.1	1.18	1.57	5.58	---	---	2.96	8.33	9.12	0.61	2.69	3.22	2.7	11.9	14.3	98	3.10	B	1345	A++	6.31	8.33	462	
1.5+2.5+2.5	1.50	2.50	2.50	---	---	2.38	6.50	6.97	0.50	1.91	2.17	2.2	8.5	9.6	98	3.40	A	955	A++	6.25	6.50	364	
1.5+2.5+3.5	1.45	2.41	3.38	---	---	2.51	7.24	7.64	0.54	2.34	2.57	2.4	10.4	11.4	98	3.09	B	1170	A++	6.11	7.24	416	
1.5+2.5+4.2	1.37	2.28	3.84	---	---	2.61	7.49	8.08	0.54	2.45	2.88	2.4	10.9	12.8	98	3.06	B	1225	A+	6.09	7.49	431	
1.5+2.5+5.0	1.30	2.16	4.32	---	---	2.73	7.77	8.53	0.57	2.59	3.09	2.5	11.5	13.7	98	3.00	C	1295	A+	6.07	7.77	449	
1.5+2.5+6.0	1.22	2.03	4.87	---	---	2.88	8.12	9.03	0.58	2.56	3.22	2.6	11.4	14.3	98	3.17	B	1280	A++	6.32	8.12	450	
1.5+2.5+7.1	1.15	1.92	5.44	---	---	3.04	8.51	9.30	0.61	2.82	3.36	2.7	12.5	14.9	98	3.02	B	1410	A++	6.28	8.51	475	
1.5+3.5+3.5	1.34	3.13	3.13	---	---	2.66	7.59	8.25	0.57	2.57	3.00	2.5	11.4	13.3	98	2.95	C	1285	A+	6.02	7.59	441	
1.5+3.5+4.2	1.28	2.98	3.58	---	---	2.76	7.84	8.48	0.57	2.69	3.13	2.5	11.9	13.9	98	2.91	C	1345	A+	5.99	7.84	459	
1.5+3.5+5.0	1.22	2.84	4.06	---	---	2.88	8.12	8.66	0.61	2.83	3.16	2.7	12.6	14.0	98	2.87	C	1415	A+	5.93	8.12	480	
1.5+3.5+6.0	1.16	2.70	4.62	---	---	3.02	8.47	9.11	0.61	2.82	3.22	2.7	12.5	14.3	98	3.00	B	1410	A++	6.25	8.47	475	
1.5+3.5+7.1	1.10	2.56	5.20	---	---	3.19	8.86	9.31	0.64	3.08	3.3												

Combination tables

Cooling

Outdoor unit	Indoor unit	Cooling capacity (kW)					Total capacity (kW)			Power input (kW)			Total current (A)			Power factor (%)	EER	Energy label	AEC (kWh)	Seasonal data			
		A room	B room	C room	D room	E room	Min.	Nom.	Max.	Min.	Nom.	Max.	Min.	Nom.	Max.					Label	SEER	Pdesign	AEC
5MXS90E	20+25+7.1	1.50	1.87	5.31	---	---	3.11	8.68	9.30	0.64	2.95	3.36	2.8	13.1	14.9	98	2.94	C	1475	A++	6.29	8.68	484
	20+35+3.5	1.73	3.02	3.02	---	---	2.73	7.77	8.47	0.57	2.69	3.13	2.5	11.9	13.9	98	2.89	C	1345	A+	6.05	7.77	450
	20+35+4.2	1.65	2.89	3.47	---	---	2.83	8.01	8.48	0.60	2.81	3.13	2.7	12.5	13.9	98	2.85	C	1405	A+	5.99	8.01	469
	20+35+5.0	1.58	2.77	3.95	---	---	2.95	8.30	8.66	0.61	2.96	3.16	2.7	13.1	14.0	98	2.80	C	1480	A+	5.96	8.30	488
	20+35+6.0	1.50	2.63	4.52	---	---	3.10	8.65	9.29	0.64	2.95	3.36	2.8	13.1	14.9	98	2.93	C	1475	A++	6.21	8.65	488
	20+35+7.1	1.43	2.50	5.07	---	---	3.26	9.00	9.31	0.68	3.15	3.36	3.0	14.0	14.9	98	2.86	C	1575	A++	6.19	9.00	509
	20+42+4.2	1.58	3.34	3.34	---	---	2.94	8.26	8.49	0.60	3.00	3.13	2.7	13.3	13.9	98	2.75	D	1500	A+	6.01	8.15	475
	20+42+5.0	1.53	3.20	3.81	---	---	3.05	8.54	8.84	0.64	3.09	3.29	2.8	13.7	14.6	98	2.76	D	1545	A+	5.93	8.54	505
	20+42+6.0	1.46	3.06	4.37	---	---	3.20	8.89	9.30	0.64	3.08	3.36	2.8	13.7	14.9	98	2.89	C	1540	A++	6.19	8.89	503
	20+42+7.1	1.36	2.84	4.80	---	---	3.36	9.00	9.32	0.68	3.15	3.36	3.0	14.0	14.9	98	2.86	C	1575	A++	6.19	9.00	509
	20+50+5.0	1.46	3.68	3.68	---	---	3.17	8.82	9.02	0.64	3.18	3.32	2.8	14.1	14.7	98	2.77	D	1590	A+	5.86	8.82	528
	20+50+6.0	1.39	3.46	4.15	---	---	3.32	9.00	9.47	0.68	2.97	3.39	3.0	13.2	15.0	98	3.03	B	1485	A++	6.18	9.00	510
	20+50+7.1	1.28	3.19	4.53	---	---	3.48	9.00	9.49	0.71	2.90	3.39	3.1	12.9	15.0	98	3.10	B	1450	A++	6.19	9.00	509
	20+60+6.0	1.28	3.86	3.86	---	---	3.46	9.00	9.93	0.68	2.68	3.46	3.0	11.9	15.4	98	3.36	A	1340	A++	6.39	9.00	493
	20+60+7.1	1.19	3.58	4.23	---	---	3.63	9.00	10.40	0.71	2.61	4.00	3.1	11.6	17.7	98	3.45	A	1305	A++	6.40	9.00	493
	25+25+2.5	2.41	2.41	2.41	---	---	2.51	7.23	7.64	0.54	2.34	2.57	2.4	10.4	11.4	98	3.09	B	1170	A++	6.23	7.23	407
	25+25+3.5	2.23	2.23	3.13	---	---	2.66	7.59	8.25	0.57	2.57	3.00	2.5	11.4	13.3	98	2.95	C	1285	A++	6.13	7.59	434
	25+25+4.2	2.13	2.13	3.58	---	---	2.76	7.84	8.47	0.57	2.69	3.13	2.5	11.9	13.9	98	2.91	C	1345	A++	6.11	7.84	450
	25+25+5.0	2.03	2.03	4.06	---	---	2.88	8.12	8.65	0.61	2.83	3.15	2.7	12.6	14.0	98	2.87	C	1415	A+	6.06	8.12	470
	25+25+6.0	1.93	1.93	4.61	---	---	3.02	8.47	9.10	0.61	2.82	3.22	2.7	12.5	14.3	98	3.00	B	1410	A++	6.34	8.47	468
	25+25+7.1	1.83	1.83	5.20	---	---	3.19	8.86	9.30	0.64	3.08	3.36	2.8	13.7	14.9	98	2.88	C	1540	A++	6.27	8.86	495
	25+35+3.5	2.08	2.93	2.93	---	---	2.80	7.94	8.47	0.60	2.75	3.13	2.7	12.2	13.9	98	2.89	C	1375	A+	6.01	7.94	463
	25+35+4.2	2.01	2.81	3.37	---	---	2.91	8.19	8.48	0.60	2.94	3.13	2.7	13.0	13.9	98	2.79	D	1470	A+	5.98	8.19	480
	25+35+5.0	1.93	2.70	3.84	---	---	3.02	8.47	8.66	0.64	3.02	3.16	2.8	13.4	14.0	98	2.80	C	1510	A+	5.95	8.47	499
	25+35+6.0	1.84	2.57	4.41	---	---	3.17	8.82	9.29	0.64	3.01	3.36	2.8	13.4	14.9	98	2.93	C	1505	A++	6.19	8.82	499
	25+35+7.1	1.72	2.40	4.88	---	---	3.33	9.00	9.31	0.68	3.15	3.36	3.0	14.0	14.9	98	2.86	C	1575	A++	6.19	9.00	509
	25+42+4.2	1.94	3.25	3.25	---	---	3.01	8.44	8.44	0.64	3.13	3.13	2.8	13.9	13.9	98	2.70	D	1565	A+	5.98	8.20	480
	25+42+5.0	1.86	3.13	3.73	---	---	3.13	8.72	8.84	0.64	3.22	3.29	2.8	14.3	14.6	98	2.71	D	1610	A+	5.93	8.55	505
	25+42+6.0	1.77	2.98	4.25	---	---	3.27	9.00	9.30	0.68	3.15	3.36	3.0	14.0	14.9	98	2.86	C	1575	A++	6.18	9.00	510
	25+42+7.1	1.63	2.74	4.63	---	---	3.44	9.00	9.32	0.71	3.15	3.36	3.1	14.0	14.9	98	2.86	C	1575	A++	6.19	9.00	509
	25+50+5.0	1.80	3.60	3.60	---	---	3.24	9.00	9.02	0.67	3.32	3.37	3.0	14.7	15.0	98	2.71	D	1660	A+	5.88	9.00	537
	25+50+6.0	1.67	3.33	4.00	---	---	3.39	9.00	9.47	0.68	3.04	3.39	3.0	13.5	15.0	98	2.96	C	1520	A++	6.18	9.00	510
	25+50+7.1	1.54	3.08	4.38	---	---	3.55	9.00	9.49	0.71	2.97	3.39	3.1	13.2	15.0	98	3.03	B	1485	A++	6.19	9.00	509
	25+60+6.0	1.56	3.72	3.72	---	---	3.54	9.00	9.93	0.71	2.75	3.46	3.1	12.2	15.4	98	3.27	A	1375	A++	6.39	9.00	493
	25+60+7.1	1.44	3.46	4.10	---	---	3.70	9.00	10.40	0.71	2.68	4.00	3.1	11.9	17.7	98	3.36	A	1340	A++	6.40	9.00	493
	35+35+3.5	2.77	2.77	2.77	---	---	2.95	8.31	8.60	0.64	3.07	3.26	2.8	13.6	14.5	98	2.71	D	1535	A+	5.92	8.31	491
	35+35+4.2	2.67	2.67	3.20	---	---	3.05	8.54	8.66	0.64	3.20	3.26	2.8	14.2	14.5	98	2.67	D	1600	A+	5.91	8.45	501
	35+35+5.0	2.57	2.57	3.68	---	---	3.17	8.82	8.84	0.67	3.29	3.32	3.0	14.6	14.7	98	2.68	D	1645	A+	5.81	8.82	532
	35+35+6.0	2.42	2.42	4.16	---	---	3.32	9.00	9.30	0.68	3.08	3.36	3.0	13.7	14.9	98	2.92	C	1540	A++	6.12	9.00	515
	35+35+7.1	2.23	2.23	4.54	---	---	3.48	9.00	9.32	0.71	3.02	3.36	3.1	13.4	14.9	98	2.98	C	1510	A++	6.18	9.00	510
35+42+4.2	2.59	3.10	3.10	---	---	3.16	8.79	8.79	0.67	3.26	3.26	3.0	14.5	14.5	98	2.70	D	1630	A+	5.91	8.46	501	
35+42+5.0	2.48	2.98	3.54	---	---	3.27	9.00	9.00	0.67	3.29	3.29	3.0	14.6	14.6	98	2.74	D	1645	A+	5.83	8.83	531	
35+42+6.0	2.30	2.76	3.94	---	---	3.42	9.00	9.31	0.71	3.15	3.36	3.1	14.0	14.9	98	2.86	C	1575	A++	6.13	9.00	515	
35+42+7.1	2.13	2.55	4.32	---	---	3.58	9.00	9.81	0.75	3.15	3.95	3.3	14.0	17.5	98	2.86	C	1575	A++	6.21	9.00	508	
35+50+5.0	2.34	3.33	3.33	---	---	3.39	9.00	9.02	0.71	3.32	3.35	3.1	14.7	14.9	98	2.71	D	1660	A+	5.83	9.00	541	
35+50+6.0	2.18	3.10	3.72	---	---	3.54	9.00	9.48	0.71	3.04	3.39	3.1	13.5	15.0	98	2.96	C	1520	A++	6.12	9.00	515	
35+50+7.1	2.02	2.88	4.10	---	---	3.70	9.00	9.94	0.75	2.97	3.91	3.3	13.2	17.3	98	3.03	B	1485	A++	6.20	9.00	508	
35+60+6.0	2.04	3.48	3.48	---	---	3.69	9.00	10.38	0.71	2.75	4.00	3.1	12.2	17.7	98	3.27	A	1375	A++	6.33	9.00	498	
42+42+4.2	3.00	3.00	3.00	---	---	3.26	9.00	9.00	0.71	3.27	3.27	3.1	14.5	14.5	98	2.75	D	1635	A+	5.92	8.47	501	
42+42+5.0	2.82	2.82	3.36	---	---	3.38	9.00	9.08	0.71	3.29	3.29	3.1	14.6	14.6	98	2.74	D	1645	A+	5.84	8.84	530	
42+42+6.0	2.63	2.63	3.74	---	---	3.52	9.00	9.32	0.71	3.15	3.36	3.1	14.0	14.9	98	2.86	C	1575	A++	6.13	9.00	514	
42+42+7.1	2.44	2.44	4.12	---	---	3.69	9.00	9.82	0.75	3.16	3.95	3.3	14.0	17.5	98	2.85	C	1580	A++	6.21	9.00	508	
42+50+5.0	2.66	3.17	3.17	---	---	3.49	9.00	9.03	0.74	3.32	3.32	3.3	14.7	14.7	98	2.71	D	1660	A+	5.83	9.00	541	
42+50+6.0	2.49	2.96	3.55	---	---	3.64	9.00	9.98	0.75	3.04	3.98	3.3	13.5	17.7	98	2.96	C	1520	A++	6.13	9.00	514	
50+50+5.0	3.00	3.00	3.00	---	---	3.61	9.00	9.78	0.75	3.21	4.07	3.3	14.2	18.1	98	2.80	C	1605	A+	5.80	9.00	544	
15+15+15+15	1.50	1.50	1.50	1.50	---	2.33	6.00	6.60	0.48	1.39	1.62	2.1	6.2	7.2	98	4.32	A	695	A++	6.20	6.00	339	
15+15+15+20	1.50	1.50	1.50	2.00	---	2.38	6.50	6.97	0.51	1.58	1.82	2.3	7.0	8.1	98	4.11	A	790	A++	6.27	6.50	363	
15+15+15+25	1.50	1.50	1.50	2.50	---	2.44	7.00	7.31	0.51	1.82	1.98	2.3	8.1	8.8	98	3.85	A	910	A++	6.32	7.00	388	
15+15+15+35	1.39	1.39	1.39	3.25	---	2.58	7.42	7.96	0.54	2.04	2.32	2.4	9.1	10.3	98	3.64	A	1020	A++	6.26	7.42	415	
15+15+15+42	1.32	1.32	1.32	3.70	---	2.69	7.66	8.36	0.54	2.26	2.69	2.4	10.0	11.9	98	3.39	A	1130	A++	6.27	7.66	428	
15+15+15+50	1.25	1.25	1.25																				

Combination tables

Cooling

Outdoor unit	Indoor unit	Cooling capacity (kW)					Total capacity (kW)			Power input (kW)			Total current (A)			Power factor (%)	EER	Energy label	AEC (kWh)	Seasonal data			
		A room	B room	C room	D room	E room	Min.	Nom.	Max.	Min.	Nom.	Max.	Min.	Nom.	Max.					Label	SEER	Pdesign	AEC
5MXS90E	15+15+42+60	1.02	1.02	2.86	4.09	---	3.35	9.00	9.96	0.65	2.81	3.46	2.9	12.5	15.4	98	3.20	A	1405	A++	6.30	9.00	501
	15+15+42+71	0.94	0.94	2.64	4.47	---	3.51	9.00	9.98	0.68	2.75	3.46	3.0	12.2	15.4	98	3.27	A	1375	A++	6.30	9.00	501
	15+15+50+50	1.04	1.04	3.46	3.46	---	3.32	9.00	9.68	0.68	2.92	3.42	3.0	13.0	15.2	98	3.08	B	1460	A+	6.09	9.00	518
	15+15+50+60	0.96	0.96	3.21	3.86	---	3.46	9.00	10.14	0.68	2.70	3.49	3.0	12.0	15.5	98	3.33	A	1350	A++	6.30	9.00	501
	15+15+50+71	0.89	0.89	2.98	4.23	---	3.63	9.00	10.46	0.71	2.70	3.88	3.1	12.0	17.2	98	3.33	A	1350	A++	6.30	9.00	501
	15+15+60+60	0.90	0.90	3.60	3.60	---	3.61	9.00	10.45	0.68	2.46	3.48	3.0	10.9	15.4	98	3.66	A	1230	A++	6.32	9.00	499
	15+15+20+20+20	1.45	1.93	1.93	1.93	---	2.51	7.24	7.64	0.51	1.93	2.15	2.3	8.6	9.5	98	3.75	A	965	A++	6.42	7.24	395
	15+20+20+25	1.39	1.86	1.86	2.32	---	2.58	7.42	7.96	0.54	2.04	2.32	2.4	9.1	10.3	98	3.64	A	1020	A++	6.41	7.42	406
	15+20+20+35	1.30	1.73	1.73	3.02	---	2.73	7.77	8.53	0.58	2.21	2.63	2.6	9.8	11.7	98	3.52	A	1105	A++	6.29	7.78	433
	15+20+20+42	1.24	1.65	1.65	3.47	---	2.83	8.01	8.88	0.58	2.50	3.08	2.6	11.1	13.7	98	3.20	A	1250	A++	6.29	8.01	447
	15+20+20+50	1.19	1.58	1.58	3.95	---	2.95	8.30	9.25	0.61	2.58	3.25	2.7	11.4	14.4	98	3.22	A	1290	A++	6.28	8.30	463
	15+20+20+60	1.13	1.50	1.50	4.51	---	3.10	8.65	9.64	0.61	2.55	3.24	2.7	11.3	14.4	98	3.39	A	1275	A++	6.38	8.65	475
	15+20+20+71	1.07	1.43	1.43	5.07	---	3.26	9.00	9.96	0.65	2.81	3.46	2.9	12.5	15.4	98	3.20	A	1405	A++	6.37	9.00	495
	15+20+25+25	1.34	1.79	2.23	2.23	---	2.66	7.59	8.25	0.54	2.09	2.50	2.4	9.3	11.1	98	3.63	A	1045	A++	6.40	7.59	415
	15+20+25+35	1.25	1.67	2.09	2.93	---	2.80	7.94	8.78	0.58	2.44	3.02	2.6	10.8	13.4	98	3.25	A	1220	A++	6.31	7.94	441
	15+20+25+42	1.20	1.61	2.01	3.37	---	2.91	8.19	9.12	0.61	2.63	3.22	2.7	11.7	14.3	98	3.11	B	1315	A++	6.30	8.19	455
	15+20+25+50	1.16	1.54	1.93	3.85	---	3.02	8.47	9.30	0.61	2.71	3.25	2.7	12.0	14.4	98	3.13	B	1355	A++	6.26	8.47	474
	15+20+25+60	1.10	1.47	1.84	4.41	---	3.17	8.82	9.81	0.64	2.68	3.38	2.8	11.9	15.0	98	3.29	A	1340	A++	6.39	8.82	484
	15+20+25+71	1.03	1.37	1.72	4.88	---	3.33	9.00	9.96	0.65	2.81	3.46	2.9	12.5	15.4	98	3.20	A	1405	A++	6.37	9.00	495
	15+20+35+35	1.19	1.58	2.77	2.77	---	2.95	8.30	9.13	0.61	2.69	3.22	2.7	11.9	14.3	98	3.09	B	1345	A++	6.21	8.30	468
	15+20+35+42	1.14	1.53	2.67	3.20	---	3.05	8.54	9.32	0.61	2.82	3.36	2.7	12.5	14.9	98	3.03	B	1410	A++	6.21	8.54	482
	15+20+35+50	1.10	1.47	2.57	3.68	---	3.17	8.82	9.49	0.64	2.90	3.39	2.8	12.9	15.0	98	3.04	B	1450	A++	6.13	8.82	504
	15+20+35+60	1.04	1.38	2.42	4.15	---	3.32	9.00	9.95	0.64	2.75	3.46	2.8	12.2	15.4	98	3.27	A	1375	A++	6.30	9.00	501
	15+20+35+71	0.96	1.28	2.23	4.53	---	3.48	9.00	9.97	0.68	2.68	3.46	3.0	11.9	15.4	98	3.36	A	1340	A++	6.32	9.00	499
	15+20+42+42	1.11	1.48	3.10	3.10	---	3.16	8.79	9.33	0.64	3.02	3.36	2.8	13.4	14.9	98	2.91	C	1510	A++	6.16	8.79	500
	15+20+42+50	1.06	1.42	2.98	3.54	---	3.27	9.00	9.50	0.68	3.04	3.39	3.0	13.5	15.0	98	2.96	C	1520	A++	6.12	9.00	515
	15+20+42+60	0.99	1.31	2.76	3.94	---	3.42	9.00	9.96	0.68	2.81	3.46	3.0	12.5	15.4	98	3.20	A	1405	A++	6.30	9.00	500
	15+20+42+71	0.91	1.22	2.55	4.32	---	3.58	9.00	10.42	0.71	2.75	4.01	3.1	12.2	17.8	98	3.27	A	1375	A++	6.32	9.00	499
	15+20+50+50	1.00	1.33	3.33	3.33	---	3.39	9.00	9.68	0.68	2.92	3.42	3.0	13.0	15.2	98	3.08	B	1460	A++	6.12	9.00	515
	15+20+50+60	0.93	1.24	3.10	3.72	---	3.54	9.00	10.14	0.68	2.70	3.49	3.0	12.0	15.5	98	3.33	A	1350	A++	6.30	9.00	500
	15+20+50+71	0.87	1.15	2.88	4.10	---	3.70	9.00	10.50	0.71	2.70	3.88	3.1	12.0	17.2	98	3.33	A	1350	A++	6.32	9.00	499
	15+20+60+60	0.87	1.16	3.48	3.48	---	3.69	9.00	10.49	0.71	2.46	3.48	3.1	10.9	15.4	98	3.66	A	1230	A++	6.31	9.00	500
	15+25+25+25	1.30	2.16	2.16	2.16	---	2.73	7.77	8.53	0.58	2.21	2.69	2.6	9.8	11.9	98	3.52	A	1105	A++	6.37	7.78	428
	15+25+25+35	1.22	2.03	2.03	2.84	---	2.88	8.12	9.03	0.58	2.56	3.22	2.6	11.4	14.3	98	3.17	B	1280	A++	6.29	8.12	452
	15+25+25+42	1.17	1.96	1.96	3.29	---	2.98	8.37	9.13	0.61	2.69	3.22	2.7	11.9	14.3	98	3.11	B	1345	A++	6.28	8.37	467
	15+25+25+50	1.13	1.88	1.88	3.76	---	3.10	8.65	9.49	0.64	2.84	3.39	2.8	12.6	15.0	98	3.05	B	1420	A++	6.21	8.65	488
	15+25+25+60	1.08	1.80	1.80	4.32	---	3.24	9.00	9.94	0.64	2.75	3.46	2.8	12.2	15.4	98	3.27	A	1375	A++	6.37	9.00	495
	15+25+25+71	0.99	1.65	1.65	4.70	---	3.41	9.00	9.96	0.68	2.68	3.46	3.0	11.9	15.4	98	3.36	A	1340	A++	6.38	9.00	494
	15+25+35+35	1.16	1.93	2.70	2.70	---	3.02	8.47	9.13	0.61	2.75	3.22	2.7	12.2	14.3	98	3.08	B	1375	A++	6.20	8.47	479
	15+25+35+42	1.12	1.86	2.61	3.13	---	3.13	8.72	9.32	0.64	2.95	3.36	2.8	13.1	14.9	98	2.96	C	1475	A++	6.16	8.72	496
	15+25+35+50	1.08	1.80	2.52	3.60	---	3.24	9.00	9.49	0.64	3.04	3.39	2.8	13.5	15.0	98	2.96	C	1520	A++	6.12	9.00	515
	15+25+35+60	1.00	1.67	2.33	4.00	---	3.39	9.00	9.95	0.68	2.75	3.46	3.0	12.2	15.4	98	3.27	A	1375	A++	6.30	9.00	500
	15+25+35+71	0.92	1.54	2.16	4.38	---	3.55	9.00	9.97	0.71	2.68	3.46	3.1	11.9	15.4	98	3.36	A	1340	A++	6.32	9.00	499
	15+25+42+42	1.08	1.81	3.03	3.03	---	3.23	8.96	9.33	0.64	3.09	3.36	2.8	13.7	14.9	98	2.90	C	1545	A++	6.14	8.96	511
	15+25+42+50	1.02	1.70	2.86	3.41	---	3.35	9.00	9.50	0.68	3.04	3.39	3.0	13.5	15.0	98	2.96	C	1520	A++	6.12	9.00	515
	15+25+42+60	0.95	1.58	2.66	3.80	---	3.49	9.00	9.96	0.68	2.81	3.46	3.0	12.5	15.4	98	3.20	A	1405	A++	6.32	9.00	499
	15+25+42+71	0.88	1.47	2.47	4.18	---	3.66	9.00	10.47	0.71	2.75	4.09	3.1	12.2	18.1	98	3.27	A	1375	A++	6.32	9.00	499
	15+25+50+50	0.96	1.60	3.20	3.20	---	3.23	8.96	9.33	0.64	3.09	3.36	2.8	13.7	14.9	98	2.90	C	1545	A++	6.12	9.00	515
	15+25+50+60	0.90	1.50	3.00	3.60	---	3.35	9.00	9.50	0.68	3.04	3.39	3.0	13.5	15.0	98	2.96	C	1520	A++	6.30	9.00	500
	15+25+50+71	1.10	2.57	2.57	2.57	---	3.17	8.82	9.32	0.64	3.02	3.36	2.8	13.4	14.9	98	2.92	C	1510	A+	6.07	8.82	509
15+35+35+42	1.06	2.48	2.48	2.98	---	3.27	9.00	9.33	0.68	3.15	3.36	3.0	14.0	14.9	98	2.86	C	1575	A+	6.08	9.00	518	
15+35+35+50	1.00	2.33	2.33	3.33	---	3.39	9.00	9.50	0.68	3.04	3.39	3.0	13.5	15.0	98	2.96	C	1520	A+	6.08	9.00	518	
15+35+35+60	0.93	2.17	2.17	3.72	---	3.54	9.00	9.96	0.68	2.75	3.46	3.0	12.2	15.4	98	3.27	A	1375	A++	6.25	9.00	505	
15+35+35+71	0.87	2.02	2.02	4.10	---	3.70	9.00	10.50	0.71	2.75	4.17	3.1	12.2	18.5	98	3.27	A	1375	A++	6.26	9.00	504	
15+35+42+42	1.01	2.35	2.82	2.82	---	3.38	9.00	9.33	0.68	3.16	3.37	3.0	14.0	15.0	98	2.85	C	1580	A++	6.12	9.00	515	
15+35+42+50	0.95	2.22	2.66	3.17	---	3.49	9.00	9.51	0.71	3.04	3.39	3.1	13.5	15.0	98	2.96	C	1520	A+	6.08	9.00	518	
15+35+42+60	0.89	2.07	2.49	3.55	---	3.64	9.00	10.47	0.71	2.82	4.17	3.1	12.5	18.5	98	3.19	B	1410	A++	6.25	9.00	504	
15+35+50+50	0.90	2.10	3.00	3.00	---	3.61	9.00	10.26	0.71	2.92	4.19	3.1	13.0	18.6	98	3.08	B	1460	A+	6.08	9.00	518	
15+42+42+42	0.96	2.68	2.68	2.68	---	3.48	9.00	9.34	0.7														

Combination tables

Cooling

Outdoor unit	Indoor unit	Cooling capacity (kW)					Total capacity (kW)			Power input (kW)			Total current (A)			Power factor (%)	EER	Energy label	AEC (kWh)	Seasonal data			
		A room	B room	C room	D room	E room	Min.	Nom.	Max.	Min.	Nom.	Max.	Min.	Nom.	Max.					Label	SEER	Pdesign	AEC
5MXS90E	20+20+50+60	1.20	1.20	3.00	3.60	---	3.61	9.00	10.45	0.71	2.70	3.88	3.1	12.0	17.2	98	3.33	A	1350	A++	6.32	9.00	499
	20+25+25+25	1.67	2.09	2.09	2.09	---	2.80	7.94	8.78	0.58	2.32	2.82	2.6	10.3	12.5	98	3.42	A	1160	A++	6.45	7.94	432
	20+25+25+35	1.57	1.98	1.98	2.77	---	2.95	8.30	9.12	0.61	2.69	3.22	2.7	11.9	14.3	98	3.09	B	1345	A++	6.29	8.30	462
	20+25+25+42	1.53	1.91	1.91	3.19	---	3.05	8.54	9.31	0.61	2.82	3.36	2.7	12.5	14.9	98	3.03	B	1410	A++	6.28	8.54	476
	20+25+25+50	1.46	1.84	1.84	3.68	---	3.17	8.82	9.49	0.64	2.90	3.39	2.8	12.9	15.0	98	3.04	B	1450	A++	6.22	8.82	497
	20+25+25+60	1.39	1.73	1.73	4.15	---	3.32	9.00	9.94	0.65	2.75	3.46	2.9	12.2	15.4	98	3.27	A	1375	A++	6.39	9.00	494
	20+25+25+71	1.27	1.60	1.60	4.53	---	3.48	9.00	9.96	0.68	2.68	3.46	3.0	11.9	15.4	98	3.36	A	1340	A++	6.39	9.00	493
	20+25+35+35	1.50	1.89	2.63	2.63	---	3.10	8.65	9.31	0.64	2.88	3.36	2.8	12.8	14.9	98	3.00	B	1440	A++	6.22	8.65	487
	20+25+35+42	1.46	1.82	2.55	3.06	---	3.20	8.89	9.32	0.64	3.08	3.36	2.8	13.7	14.9	98	2.89	C	1540	A++	6.20	8.89	502
	20+25+35+50	1.39	1.73	2.42	3.46	---	3.32	9.00	9.49	0.68	3.04	3.39	3.0	13.5	15.0	98	2.96	C	1520	A++	6.20	9.00	509
	20+25+35+60	1.28	1.61	2.25	3.86	---	3.46	9.00	9.95	0.68	2.75	3.46	3.0	12.2	15.4	98	3.27	A	1375	A++	6.32	9.00	499
	20+25+35+71	1.19	1.49	2.09	4.23	---	3.63	9.00	10.42	0.71	2.68	4.01	3.1	11.9	17.8	98	3.36	A	1340	A++	6.32	9.00	499
	20+25+42+42	1.40	1.74	2.93	2.93	---	3.30	9.00	9.33	0.68	3.15	3.36	3.0	14.0	14.9	98	2.86	C	1575	A++	6.20	9.00	508
	20+25+42+50	1.32	1.64	2.76	3.28	---	3.42	9.00	9.50	0.68	3.04	3.39	3.0	13.5	15.0	98	2.96	C	1520	A++	6.20	9.00	509
	20+25+42+60	1.23	1.53	2.57	3.67	---	3.57	9.00	10.41	0.71	2.81	4.00	3.1	12.5	17.7	98	3.20	A	1405	A++	6.33	9.00	498
	20+25+50+50	1.25	1.55	3.10	3.10	---	3.54	9.00	9.68	0.71	2.92	3.42	3.1	13.0	15.2	98	3.08	B	1460	A++	6.20	9.00	509
	20+25+50+60	1.17	1.45	2.90	3.48	---	3.69	9.00	10.49	0.71	2.70	3.96	3.1	12.0	17.6	98	3.33	A	1350	A++	6.32	9.00	499
	20+25+50+71	1.44	2.52	2.52	2.52	---	3.24	9.00	9.32	0.68	3.15	3.36	3.0	14.0	14.9	98	2.86	C	1575	A++	6.14	9.00	514
	20+35+35+42	1.36	2.39	2.39	2.86	---	3.35	9.00	9.33	0.68	3.15	3.36	3.0	14.0	14.9	98	2.86	C	1575	A++	6.14	9.00	514
	20+35+35+50	1.29	2.25	2.25	3.21	---	3.46	9.00	9.50	0.71	3.04	3.39	3.1	13.5	15.0	98	2.96	C	1520	A++	6.14	9.00	514
	20+35+35+60	1.20	2.10	2.10	3.60	---	3.61	9.00	10.40	0.71	2.75	4.01	3.1	12.2	17.8	98	3.27	A	1375	A++	6.26	9.00	504
	20+35+35+71	1.29	2.27	2.72	2.72	---	3.45	9.00	9.33	0.71	3.16	3.37	3.1	14.0	15.0	98	2.85	C	1580	A++	6.15	9.00	513
	20+35+42+50	1.23	2.14	2.57	3.06	---	3.57	9.00	10.00	0.71	3.04	3.99	3.1	13.5	17.7	98	2.96	C	1520	A++	6.14	9.00	513
	20+35+50+50	1.17	2.03	2.90	2.90	---	3.69	9.00	10.26	0.75	2.92	4.19	3.3	13.0	18.6	98	3.08	B	1460	A++	6.14	9.00	514
	20+42+42+42	1.23	2.59	2.59	2.59	---	3.55	9.00	9.34	0.71	3.16	3.37	3.1	14.0	15.0	98	2.85	C	1580	A++	6.15	9.00	513
	20+42+42+50	1.18	2.45	2.45	2.92	---	3.67	9.00	10.01	0.75	3.04	3.99	3.3	13.5	17.7	98	2.96	C	1520	A++	6.15	9.00	513
	25+25+25+25	2.03	2.03	2.03	2.03	---	2.88	8.12	9.03	0.58	2.56	3.22	2.6	11.4	14.3	98	3.17	B	1280	A++	6.43	8.12	443
	25+25+25+35	1.93	1.93	1.93	2.68	---	3.02	8.47	9.12	0.61	2.82	3.22	2.7	12.5	14.3	98	3.00	B	1410	A++	6.29	8.47	472
	25+25+25+42	1.87	1.86	1.86	3.13	---	3.13	8.72	9.31	0.64	2.95	3.36	2.8	13.1	14.9	98	2.96	C	1475	A++	6.29	8.72	486
	25+25+25+50	1.80	1.80	1.80	3.60	---	3.24	9.00	9.49	0.64	3.04	3.39	2.8	13.5	15.0	98	2.96	C	1520	A++	6.21	9.00	508
	25+25+25+60	1.67	1.67	1.67	3.99	---	3.39	9.00	9.94	0.68	2.75	3.46	3.0	12.2	15.4	98	3.27	A	1375	A++	6.39	9.00	493
	25+25+25+71	1.54	1.54	1.54	4.38	---	3.55	9.00	9.96	0.71	2.68	3.46	3.1	11.9	15.4	98	3.36	A	1340	A++	6.39	9.00	493
	25+25+35+35	1.84	1.84	2.57	2.57	---	3.17	8.82	9.31	0.64	3.02	3.36	2.8	13.4	14.9	98	2.92	C	1510	A++	6.22	8.82	497
	25+25+35+42	1.77	1.77	2.48	2.98	---	3.27	9.00	9.32	0.68	3.15	3.36	3.0	14.0	14.9	98	2.86	C	1575	A++	6.20	9.00	509
	25+25+35+50	1.67	1.67	2.33	3.33	---	3.39	9.00	9.49	0.68	3.04	3.39	3.0	13.5	15.0	98	2.96	C	1520	A++	6.20	9.00	509
	25+25+35+60	1.55	1.55	2.18	3.72	---	3.54	9.00	9.95	0.71	2.75	3.46	3.1	12.2	15.4	98	3.27	A	1375	A++	6.32	9.00	499
	25+25+35+71	1.44	1.44	2.02	4.10	---	3.70	9.00	10.42	0.71	2.68	4.01	3.1	11.9	17.8	98	3.36	A	1340	A++	6.32	9.00	499
	25+25+42+42	1.68	1.68	2.82	2.82	---	3.38	9.00	9.33	0.68	3.15	3.36	3.0	14.0	14.9	98	2.86	C	1575	A++	6.20	9.00	508
	25+25+42+50	1.58	1.58	2.67	3.17	---	3.49	9.00	9.50	0.71	3.04	3.39	3.1	13.5	15.0	98	2.96	C	1520	A++	6.20	9.00	508
	25+25+42+60	1.48	1.48	2.49	3.55	---	3.64	9.00	10.47	0.71	2.81	4.00	3.1	12.5	17.7	98	3.20	A	1405	A++	6.32	9.00	499
	25+25+50+50	1.50	1.50	3.00	3.00	---	3.61	9.00	10.25	0.71	2.92	4.18	3.1	13.0	18.5	98	3.08	B	1460	A++	6.20	9.00	509
	25+35+35+35	1.74	2.42	2.42	2.42	---	3.32	9.00	9.34	0.68	3.15	3.36	3.0	14.0	14.9	98	2.86	C	1575	A++	6.14	9.00	514
	25+35+35+42	1.64	2.30	2.30	2.76	---	3.42	9.00	9.33	0.71	3.15	3.36	3.1	14.0	14.9	98	2.86	C	1575	A++	6.14	9.00	513
	25+35+35+50	1.56	2.17	2.17	3.10	---	3.54	9.00	9.50	0.71	3.04	3.39	3.1	13.5	15.0	98	2.96	C	1520	A++	6.14	9.00	514
	25+35+35+60	1.46	2.03	2.03	3.48	---	3.69	9.00	10.40	0.71	2.75	4.01	3.1	12.2	17.8	98	3.27	A	1375	A++	6.26	9.00	504
	25+35+42+42	1.56	2.18	2.63	2.63	---	3.52	9.00	9.33	0.71	3.16	3.37	3.1	14.0	15.0	98	2.85	C	1580	A++	6.15	9.00	513
	25+35+42+50	1.48	2.07	2.49	2.96	---	3.64	9.00	10.00	0.75	3.04	3.99	3.3	13.5	17.7	98	2.96	C	1520	A++	6.15	9.00	513
	25+35+42+60	1.50	2.50	2.50	2.50	---	3.63	9.00	9.83	0.75	3.16	3.95	3.3	14.0	17.5	98	2.85	C	1580	A++	6.15	9.00	513
	35+35+35+35	2.25	2.25	2.25	2.25	---	3.46	9.00	9.32	0.71	3.15	3.36	3.1	14.0	14.9	98	2.86	C	1575	A+	6.08	9.00	518
	35+35+35+42	2.14	2.14	2.14	2.58	---	3.57	9.00	9.82	0.75	3.16	3.95	3.3	14.0	17.5	98	2.85	C	1580	A+	6.08	9.00	518
35+35+35+50	2.03	2.03	2.03	2.91	---	3.69	9.00	9.95	0.75	3.04	3.91	3.3	13.5	17.3	98	2.96	C	1520	A+	6.08	9.00	518	
35+35+42+42	2.05	2.05	2.45	2.45	---	3.67	9.00	9.83	0.75	3.16	3.95	3.3	14.0	17.5	98	2.85	C	1580	A+	6.08	9.00	518	
15+15+15+15	1.45	1.45	1.45	1.45	1.45	2.51	7.24	7.64	0.52	1.79	2.01	2.3	7.9	8.9	98	4.04	A	895	A++	6.39	7.24	397	
15+15+15+20	1.39	1.39	1.39	1.39	1.86	2.58	7.42	7.96	0.52	1.90	2.18	2.3	8.4	9.7	98	3.91	A	950	A++	6.40	7.42	407	
15+15+15+25	1.34	1.34	1.34	1.34	2.23	2.66	7.59	8.25	0.55	2.01	2.36	2.4	8.9	10.5	98	3.78	A	1005	A++	6.41	7.59	415	
15+15+15+35	1.25	1.25	1.25	1.25	2.93	2.80	7.94	8.78	0.58	2.18	2.68	2.6	9.7	11.9	98	3.64	A	1090	A++	6.29	7.94	442	
15+15+15+42	1.20	1.20	1.20	1.20	3.37	2.91	8.19	9.12	0.58	2.30	2.88	2.6	10.2	12.8	98	3.56	A	1150	A++	6.29	8.19	456	
15+15+15+50	1.16	1.16	1.16	1.16	3.85	3.02	8.47	9.45	0.61	2.37	2.97	2.7	10.5	13.2	98	3.57	A	1185	A++	6.29	8.47	472	
15+15+15+60	1.10	1.10	1.10	1.10	4.41	3.																	

Combination tables

Cooling

Outdoor unit	Indoor unit	Cooling capacity (kW)					Total capacity (kW)			Power input (kW)			Total current (A)			Power factor (%)	EER	Energy label	AEC (kWh)	Seasonal data			
		A room	B room	C room	D room	E room	Min.	Nom.	Max.	Min.	Nom.	Max.	Min.	Nom.	Max.					Label	SEER	Pdesign	AEC
5MXS90E	154504120	1.30	1.30	1.73	1.73	1.73	2.73	7.77	8.53	0.55	2.06	2.49	2.4	9.1	11.0	98	3.77	A	1030	A++	6.42	7.78	424
	154504125	1.25	1.25	1.67	1.67	2.09	2.80	7.94	8.78	0.58	2.18	2.68	2.6	9.7	11.9	98	3.64	A	1090	A++	6.39	7.94	435
	154504135	1.19	1.19	1.58	1.58	2.77	2.95	8.30	9.25	0.58	2.36	2.95	2.6	10.5	13.1	98	3.52	A	1180	A++	6.32	8.30	460
	154504140	1.14	1.14	1.53	1.53	3.20	3.05	8.54	9.53	0.61	2.49	3.17	2.7	11.0	14.1	98	3.43	A	1245	A++	6.31	8.54	474
	154504145	1.10	1.10	1.47	1.47	3.68	3.17	8.82	9.81	0.61	2.56	3.26	2.7	11.4	14.5	98	3.45	A	1280	A++	6.25	8.82	495
	154504146	1.04	1.04	1.38	1.38	4.15	3.32	9.00	10.09	0.65	2.46	3.17	2.9	10.9	14.1	98	3.66	A	1230	A++	6.24	9.00	505
	154504147	0.96	0.96	1.28	1.28	4.53	3.48	9.00	10.32	0.65	2.47	3.33	2.9	11.0	14.8	98	3.64	A	1235	A++	6.24	9.00	506
	154504148	1.22	1.22	1.62	2.03	2.03	2.88	8.12	9.03	0.58	2.24	2.81	2.6	9.9	12.5	98	3.63	A	1120	A++	6.39	8.12	445
	154504149	1.16	1.16	1.54	1.93	2.70	3.02	8.47	9.45	0.61	2.49	3.09	2.7	11.0	13.7	98	3.40	A	1245	A++	6.30	8.47	471
	154504150	1.12	1.12	1.49	1.86	3.13	3.13	8.72	9.71	0.61	2.62	3.31	2.7	11.6	14.7	98	3.33	A	1310	A++	6.29	8.72	486
	154504151	1.08	1.08	1.44	1.80	3.60	3.24	9.00	9.96	0.65	2.70	3.41	2.9	12.0	15.1	98	3.33	A	1350	A++	6.25	9.00	505
	154504152	1.00	1.00	1.33	1.67	4.00	3.39	9.00	10.21	0.65	2.46	3.32	2.9	10.9	14.7	98	3.66	A	1230	A++	6.24	9.00	505
	154504153	0.92	0.92	1.23	1.54	4.38	3.55	9.00	10.40	0.68	2.47	3.40	3.0	11.0	15.1	98	3.64	A	1235	A++	6.24	9.00	506
	154504154	1.10	1.10	1.47	2.57	2.57	3.17	8.82	9.81	0.61	2.68	3.39	2.7	11.9	15.0	98	3.29	A	1340	A++	6.20	8.82	498
	154504155	1.06	1.06	1.42	2.48	2.98	3.27	9.00	9.98	0.65	2.75	3.46	2.9	12.2	15.4	98	3.27	A	1375	A++	6.18	9.00	510
	154504156	1.00	1.00	1.33	2.33	3.33	3.39	9.00	10.16	0.65	2.70	3.49	2.9	12.0	15.5	98	3.33	A	1350	A++	6.18	9.00	510
	154504157	0.93	0.93	1.24	2.17	3.72	3.54	9.00	10.38	0.68	2.46	3.40	3.0	10.9	15.1	98	3.66	A	1230	A++	6.18	9.00	511
	154504158	0.87	0.87	1.15	2.02	4.10	3.70	9.00	10.50	0.71	2.47	3.48	3.1	11.0	15.4	98	3.64	A	1235	A++	6.17	9.00	511
	154504159	1.01	1.01	1.34	2.82	2.82	3.38	9.00	9.99	0.68	2.75	3.47	3.0	12.2	15.4	98	3.27	A	1375	A++	6.18	9.00	510
	154504160	0.95	0.95	1.27	2.66	3.17	3.49	9.00	10.16	0.68	2.70	3.49	3.0	12.0	15.5	98	3.33	A	1350	A++	6.18	9.00	510
	154504161	0.89	0.89	1.18	2.49	3.55	3.64	9.00	10.47	0.68	2.47	3.48	3.0	11.0	15.4	98	3.64	A	1235	A++	6.17	9.00	511
	154504162	0.90	0.90	1.20	3.00	3.00	3.61	9.00	10.45	0.68	2.58	3.68	3.0	11.4	16.3	98	3.49	A	1290	A++	6.18	9.00	510
	154504163	1.19	1.19	1.98	1.98	1.98	2.95	8.30	9.25	0.58	2.36	2.95	2.6	10.5	13.1	98	3.52	A	1180	A++	6.39	8.30	455
	154504164	1.13	1.13	1.88	1.88	2.63	3.10	8.65	9.64	0.61	2.55	3.24	2.7	11.3	14.4	98	3.39	A	1275	A++	6.30	8.65	481
	154504165	1.09	1.09	1.82	1.82	3.06	3.20	8.89	9.87	0.65	2.68	3.39	2.9	11.9	15.0	98	3.32	A	1340	A++	6.24	8.89	499
	154504166	1.04	1.04	1.73	1.73	3.46	3.32	9.00	10.09	0.65	2.70	3.49	2.9	12.0	15.5	98	3.33	A	1350	A++	6.25	9.00	505
	154504167	0.96	0.96	1.61	1.61	3.86	3.46	9.00	10.31	0.65	2.46	3.40	2.9	10.9	15.1	98	3.66	A	1230	A++	6.24	9.00	505
	154504168	0.89	0.89	1.49	1.49	4.23	3.63	9.00	10.46	0.68	2.47	3.48	3.0	11.0	15.4	98	3.64	A	1235	A++	6.24	9.00	506
	154504169	1.08	1.08	1.80	2.52	2.52	3.24	9.00	9.96	0.65	2.82	3.46	2.9	12.5	15.4	98	3.19	B	1410	A++	6.18	9.00	510
	154504170	1.02	1.02	1.70	2.39	2.86	3.35	9.00	9.98	0.65	2.75	3.46	2.9	12.2	15.4	98	3.27	A	1375	A++	6.18	9.00	510
	154504171	0.96	0.96	1.61	2.25	3.21	3.46	9.00	10.16	0.68	2.70	3.49	3.0	12.0	15.5	98	3.33	A	1350	A++	6.18	9.00	510
	154504172	0.90	0.90	1.50	2.10	3.60	3.61	9.00	10.45	0.68	2.46	3.48	3.0	10.9	15.4	98	3.66	A	1230	A++	6.17	9.00	511
	154504173	0.97	0.97	1.62	2.72	2.72	3.45	9.00	9.99	0.68	2.75	3.47	3.0	12.2	15.4	98	3.27	A	1375	A++	6.18	9.00	510
	154504174	0.92	0.92	1.53	2.57	3.06	3.57	9.00	10.41	0.68	2.70	3.81	3.0	12.0	16.9	98	3.33	A	1350	A++	6.18	9.00	510
	154504175	0.87	0.87	1.45	2.90	2.90	3.69	9.00	10.49	0.71	2.58	3.68	3.1	11.4	16.3	98	3.49	A	1290	A++	6.18	9.00	510
	154504176	1.00	1.00	2.33	2.33	2.33	3.39	9.00	9.98	0.68	2.82	3.46	3.0	12.5	15.4	98	3.19	B	1410	A++	6.12	9.00	515
	154504177	0.95	0.95	2.22	2.22	2.66	3.49	9.00	9.99	0.68	2.75	3.47	3.0	12.2	15.4	98	3.27	A	1375	A++	6.12	9.00	515
	154504178	0.90	0.90	2.10	2.10	3.00	3.61	9.00	10.45	0.71	2.70	3.80	3.1	12.0	16.9	98	3.33	A	1350	A++	6.12	9.00	515
	154504179	0.91	0.91	2.11	2.54	2.54	3.60	9.00	10.44	0.71	2.75	4.01	3.1	12.2	17.8	98	3.27	A	1375	A++	6.12	9.00	515
	154504180	1.25	1.25	1.67	1.67	1.67	2.80	7.94	8.78	0.58	2.18	2.68	2.6	9.7	11.9	98	3.64	A	1090	A++	6.41	7.94	434
	154504181	1.22	1.62	1.62	1.62	2.03	2.88	8.12	9.03	0.58	2.24	2.81	2.6	9.9	12.5	98	3.63	A	1120	A++	6.39	8.12	445
	154504182	1.16	1.54	1.54	1.54	2.70	3.02	8.47	9.45	0.61	2.49	3.09	2.7	11.0	13.7	98	3.40	A	1245	A++	6.32	8.47	470
	154504183	1.12	1.49	1.49	1.49	3.13	3.13	8.72	9.71	0.61	2.62	3.31	2.7	11.6	14.7	98	3.33	A	1310	A++	6.29	8.72	486
	154504184	1.08	1.44	1.44	1.44	3.60	3.24	9.00	9.96	0.65	2.70	3.41	2.9	12.0	15.1	98	3.33	A	1350	A++	6.24	9.00	505
	154504185	1.00	1.33	1.33	1.33	4.00	3.39	9.00	10.21	0.65	2.46	3.32	2.9	10.9	14.7	98	3.66	A	1230	A++	6.24	9.00	506
	154504186	0.92	1.23	1.23	1.23	4.38	3.55	9.00	10.40	0.68	2.47	3.40	3.0	11.0	15.1	98	3.64	A	1235	A++	6.23	9.00	506
	154504187	1.19	1.58	1.58	1.98	1.98	2.95	8.30	9.25	0.58	2.36	2.95	2.6	10.5	13.1	98	3.52	A	1180	A++	6.39	8.30	455
	154504188	1.13	1.50	1.50	1.88	2.63	3.10	8.65	9.64	0.61	2.55	3.24	2.7	11.3	14.4	98	3.39	A	1275	A++	6.30	8.65	481
	154504189	1.09	1.46	1.46	1.82	3.06	3.20	8.89	9.87	0.65	2.68	3.39	2.9	11.9	15.0	98	3.32	A	1340	A++	6.24	8.89	499
	154504190	1.04	1.38	1.38	1.73	3.46	3.32	9.00	10.09	0.65	2.70	3.49	2.9	12.0	15.5	98	3.33	A	1350	A++	6.25	9.00	505
154504191	0.96	1.29	1.29	1.61	3.86	3.46	9.00	10.31	0.65	2.46	3.40	2.9	10.9	15.1	98	3.66	A	1230	A++	6.23	9.00	506	
154504192	0.89	1.19	1.19	1.49	4.23	3.63	9.00	10.46	0.68	2.47	3.4												

Combination tables

Cooling

Outdoor unit	Indoor unit	Cooling capacity (kW)					Total capacity (kW)			Power input (kW)			Total current (A)			Power factor (%)	EER	Energy label	AEC (kWh)	Seasonal data			
		A room	B room	C room	D room	E room	Min.	Nom.	Max.	Min.	Nom.	Max.	Min.	Nom.	Max.					Label	SEER	Pdesign	AEC
5MXS90E	1542541442	0.91	1.51	1.51	2.54	2.54	3.60	9.00	10.44	0.71	2.75	4.09	3.1	12.2	18.1	98	3.27	A	1375	A++	6.18	9.00	510
	1542541543	0.93	1.55	2.17	2.17	2.17	3.54	9.00	9.98	0.68	2.82	3.46	3.0	12.5	15.4	98	3.19	B	1410	A++	6.12	9.00	515
	1542541642	0.89	1.48	2.07	2.07	2.49	3.64	9.00	10.47	0.71	2.75	4.09	3.1	12.2	18.1	98	3.27	A	1375	A++	6.12	9.00	515
	1542541743	0.87	2.03	2.03	2.03	2.03	3.69	9.00	10.49	0.71	2.75	4.17	3.1	12.2	18.5	98	3.27	A	1375	A+	6.06	9.00	521
	1642441141	1.63	1.63	1.63	1.63	1.63	2.88	8.15	9.03	0.58	2.30	2.81	2.6	10.2	12.5	98	3.54	A	1150	A++	6.40	8.15	446
	1642441243	1.58	1.58	1.58	1.58	1.98	2.95	8.30	9.25	0.58	2.36	2.95	2.6	10.5	13.1	98	3.52	A	1180	A++	6.39	8.30	455
	1642441343	1.50	1.50	1.50	1.50	2.65	3.10	8.65	9.64	0.61	2.55	3.24	2.7	11.3	14.4	98	3.39	A	1275	A++	6.30	8.65	481
	1642441442	1.46	1.46	1.46	1.46	3.05	3.20	8.89	9.87	0.65	2.68	3.39	2.9	11.9	15.0	98	3.32	A	1340	A++	6.24	8.89	499
	1642441543	1.38	1.38	1.38	1.38	3.48	3.32	9.00	10.09	0.65	2.70	3.49	2.9	12.0	15.5	98	3.33	A	1350	A++	6.25	9.00	505
	1642441640	1.29	1.29	1.29	1.29	3.84	3.46	9.00	10.31	0.65	2.50	3.40	2.9	11.1	15.1	98	3.60	A	1250	A++	6.23	9.00	506
	1642441741	1.19	1.19	1.19	1.19	4.24	3.63	9.00	10.46	0.68	2.47	3.48	3.0	11.0	15.4	98	3.64	A	1235	A++	6.21	9.00	508
	1642441843	1.54	1.54	1.54	1.92	1.92	3.02	8.46	9.45	0.61	2.49	3.09	2.7	11.0	13.7	98	3.40	A	1245	A++	6.38	8.46	464
	1642441943	1.47	1.47	1.47	1.84	2.57	3.17	8.82	9.81	0.61	2.68	3.39	2.7	11.9	15.0	98	3.29	A	1340	A++	6.27	8.82	493
	1642442042	1.42	1.42	1.42	1.77	2.97	3.27	9.00	9.97	0.65	2.82	3.46	2.9	12.5	15.4	98	3.19	B	1410	A++	6.25	9.00	505
	1642442143	1.33	1.33	1.33	1.67	3.34	3.39	9.00	10.15	0.65	2.70	3.49	2.9	12.0	15.5	98	3.33	A	1350	A++	6.25	9.00	505
	1642442240	1.24	1.24	1.24	1.55	3.73	3.54	9.00	10.38	0.68	2.50	3.40	3.0	11.1	15.1	98	3.60	A	1250	A++	6.22	9.00	507
	1642442341	1.15	1.15	1.15	1.44	4.11	3.70	9.00	10.50	0.71	2.47	3.48	3.1	11.0	15.4	98	3.64	A	1235	A++	6.21	9.00	508
	1642442443	1.54	1.54	1.54	1.92	1.92	3.02	8.46	9.45	0.61	2.49	3.09	2.7	11.0	13.7	98	3.40	A	1245	A++	6.24	8.46	475
	1642442542	1.31	1.31	1.31	2.31	2.76	3.42	9.00	9.98	0.68	2.75	3.46	3.0	12.2	15.4	98	3.27	A	1375	A++	6.18	9.00	510
	1642442640	1.24	1.24	1.24	2.17	3.11	3.54	9.00	10.16	0.68	2.74	3.49	3.0	12.2	15.5	98	3.28	A	1370	A++	6.18	9.00	510
	1642442740	1.16	1.16	1.16	2.03	3.49	3.69	9.00	10.49	0.71	2.46	3.48	3.1	10.9	15.4	98	3.66	A	1230	A++	6.15	9.00	513
	1642442842	1.24	1.24	1.24	2.64	2.64	3.52	9.00	9.99	0.68	2.75	3.47	3.0	12.2	15.4	98	3.27	A	1375	A++	6.18	9.00	510
	1642442940	1.18	1.18	1.18	2.50	2.96	3.64	9.00	10.47	0.71	2.70	3.89	3.1	12.0	17.3	98	3.33	A	1350	A++	6.18	9.00	510
	1642443043	1.51	1.51	1.88	1.88	1.88	3.10	8.66	9.64	0.61	2.55	3.24	2.7	11.3	14.4	98	3.40	A	1275	A++	6.37	8.66	477
	1642443143	1.44	1.44	1.80	1.80	2.52	3.24	9.00	9.96	0.65	2.82	3.46	2.9	12.5	15.4	98	3.19	B	1410	A++	6.25	9.00	505
	1642443242	1.37	1.37	1.70	1.70	2.86	3.35	9.00	9.66	0.65	2.86	3.46	2.9	12.7	15.4	98	3.15	B	1430	A++	6.25	9.00	505
	1642443340	1.29	1.29	1.61	1.61	3.20	3.46	9.00	10.15	0.68	2.70	3.49	3.0	12.0	15.5	98	3.33	A	1350	A++	6.25	9.00	505
	1642443440	1.20	1.20	1.50	1.50	3.60	3.61	9.00	10.45	0.68	2.46	3.48	3.0	10.9	15.4	98	3.66	A	1230	A++	6.22	9.00	507
	1642443543	1.33	1.33	1.68	2.33	2.33	3.39	9.00	9.97	0.68	2.82	3.46	3.0	12.5	15.4	98	3.19	B	1410	A++	6.18	9.00	510
	1642443642	1.27	1.27	1.58	2.22	2.66	3.49	9.00	9.66	0.68	2.79	3.46	3.0	12.4	15.4	98	3.23	A	1395	A++	6.18	9.00	510
	1642443740	1.20	1.20	1.50	2.10	3.00	3.61	9.00	10.45	0.71	2.70	3.80	3.1	12.0	16.9	98	3.33	A	1350	A++	6.18	9.00	510
	1642443842	1.21	1.21	1.50	2.54	2.54	3.60	9.00	10.44	0.71	2.75	4.01	3.1	12.2	17.8	98	3.27	A	1375	A++	6.18	9.00	510
	1642443943	1.23	1.23	2.18	2.18	2.18	3.54	9.00	9.98	0.68	2.82	3.46	3.0	12.5	15.4	98	3.19	B	1410	A++	6.12	9.00	515
	1642444042	1.18	1.18	2.07	2.07	2.50	3.64	9.00	10.47	0.71	2.75	4.01	3.1	12.2	17.8	98	3.27	A	1375	A++	6.12	9.00	515
	1642444143	1.46	1.84	1.84	1.84	1.84	3.17	8.82	9.81	0.61	2.68	3.39	2.7	11.9	15.0	98	3.29	A	1340	A++	6.34	8.82	488
	1642444243	1.39	1.73	1.73	1.73	2.42	3.32	9.00	9.96	0.65	2.82	3.46	2.9	12.5	15.4	98	3.19	B	1410	A++	6.25	9.00	505
	1642444342	1.32	1.64	1.64	1.64	2.76	3.42	9.00	9.97	0.68	2.82	3.46	3.0	12.5	15.4	98	3.19	B	1410	A++	6.25	9.00	505
	1642444440	1.25	1.55	1.55	1.55	3.10	3.54	9.00	10.15	0.68	2.70	3.49	3.0	12.0	15.5	98	3.33	A	1350	A++	6.25	9.00	505
	1642444540	1.17	1.45	1.45	1.45	3.48	3.69	9.00	10.49	0.71	2.46	3.48	3.1	10.9	15.4	98	3.66	A	1230	A++	6.22	9.00	507
	1642444643	1.28	1.61	1.61	2.25	2.25	3.46	9.00	9.97	0.68	2.82	3.46	3.0	12.5	15.4	98	3.19	B	1410	A++	6.18	9.00	510
1642444742	1.23	1.53	1.53	2.14	2.57	3.57	9.00	10.41	0.71	2.75	4.01	3.1	12.2	17.8	98	3.27	A	1375	A++	6.18	9.00	510	
1642444840	1.17	1.45	1.45	2.03	2.90	3.69	9.00	10.49	0.71	2.70	3.88	3.1	12.0	17.2	98	3.33	A	1350	A++	6.18	9.00	510	
1642444942	1.18	1.46	1.46	2.45	2.45	3.64	9.00	10.47	0.71	2.75	4.01	3.1	12.2	17.8	98	3.27	A	1375	A++	6.18	9.00	510	
1642445043	1.20	1.50	2.10	2.10	2.10	3.61	9.00	10.42	0.71	2.82	4.01	3.1	12.5	17.8	98	3.19	B	1410	A++	6.12	9.00	515	
1642445143	1.80	1.80	1.80	1.80	3.24	3.24	9.00	9.95	0.65	2.81	3.46	2.9	12.5	15.4	98	3.20	A	1405	A++	6.31	9.00	499	
1642445243	1.67	1.67	1.67	1.67	2.32	3.39	9.00	9.96	0.68	2.75	3.46	3.0	12.2	15.4	98	3.27	A	1375	A++	6.25	9.00	505	
1642445342	1.58	1.58	1.58	1.58	2.68	3.49	9.00	9.97	0.68	2.82	3.46	3.0	12.5	15.4	98	3.19	B	1410	A++	6.25	9.00	505	
1642445440	1.50	1.50	1.50	1.50	3.00	3.61	9.00	10.45	0.71	2.70	3.88	3.1	12.0	17.2	98	3.33	A	1350	A++	6.25	9.00	505	
1642445543	1.56	1.56	1.56	2.16	2.16	3.54	9.00	9.97	0.68	2.82	3.46	3.0	12.5	15.4	98	3.19	B	1410	A++	6.18	9.00	510	
1642445642	1.48	1.48	1.48	2.07	2.49	3.64	9.00	10.47	0.71	2.75	4.01	3.1	12.2	17.8	98	3.27	A	1375	A++	6.18	9.00	510	
1642445743	1.44	1.44	2.04	2.04	2.04	3.69	9.00	10.42	0.71	2.75	4.01	3.1	12.2	17.8	98	3.27	A	1375	A++	6.12	9.00	515	

- Notes:
- Cooling capacity is based on 27°CDB/19°CWB (Indoor temperature), 35°CDB (Outdoor temperature). Heating capacity is based on 20°CDB (Indoor temperature), 7°CDB/6°CWB (Outdoor temperature).
 - The total ability of connected indoor unit is up to 14.5kW.
 - It is impossible to connect the indoor unit for one room only.
 - The above is the value for connecting with the following indoor units.
 1.5kW: wall mounted CTXS-K series; 2.0, 2.5, 3.5, 4.2, 5.0kW: wall mounted FTXS-K series
 6.0, 7.1 kW class; wall mounted G series

Combination tables

Heating

Outdoor unit	Indoor unit	Heating capacity (kW)					Total capacity (kW)			Power input (kW)			Total current (A)			Power factor (%)	COP	Energy label	Seasonal data				
		A room	B room	C room	D room	E room	Min.	Nom.	Max.	Min.	Nom.	Max.	Min.	Nom.	Max.				Label	SCOP	Pdesign	AEC	Back-up heater capacity at -10°C
5MXS90E	1.5+1.5	1.83	1.83	---	---	---	1.48	3.66	5.75	0.39	0.91	1.48	1.7	4.0	6.6	98	4.02	A	A	3.85	3.41	1239	0.63
	1.5+2.0	1.83	2.44	---	---	---	1.54	4.27	5.75	0.37	1.04	1.48	1.6	4.6	6.6	98	4.11	A	A	3.85	3.47	1262	0.62
	1.5+2.5	1.83	3.05	---	---	---	1.69	4.88	7.46	0.39	1.21	2.09	1.7	5.4	9.3	98	4.03	A	A	3.86	3.50	1269	0.64
	1.5+3.5	1.83	4.26	---	---	---	1.98	6.09	7.46	0.47	1.71	2.29	2.1	7.6	10.2	98	3.56	B	A	3.82	3.82	1399	0.68
	1.5+4.2	1.83	5.12	---	---	---	2.19	6.95	8.53	0.45	2.09	2.81	2.0	9.3	12.5	98	3.33	C	A	3.84	3.86	1409	0.72
	1.5+5.0	1.83	6.09	---	---	---	2.43	7.92	9.09	0.47	2.16	2.66	2.1	9.6	11.8	98	3.67	A	A	3.84	3.78	1377	0.71
	1.5+6.0	1.79	7.14	---	---	---	2.72	8.93	9.88	0.51	2.47	2.96	2.3	11.0	13.1	98	3.62	A	A	3.84	4.30	1567	0.81
	1.5+7.1	1.69	8.00	---	---	---	3.03	9.69	9.90	0.55	2.83	2.94	2.4	12.6	13.0	98	3.42	B	A	3.86	4.53	1643	0.84
	2.0+2.0	2.44	2.44	---	---	---	1.69	4.88	6.85	0.39	1.21	1.87	1.7	5.4	8.3	98	4.03	A	A	3.85	3.54	1289	0.68
	2.0+2.5	2.44	3.05	---	---	---	1.84	5.49	7.25	0.41	1.40	2.05	1.8	6.2	9.1	98	3.92	A	A	3.84	3.57	1303	0.64
	2.0+3.5	2.44	4.26	---	---	---	2.13	6.70	7.74	0.50	1.99	2.44	2.2	8.8	10.8	98	3.37	C	A	3.82	3.91	1432	0.70
	2.0+4.2	2.44	5.11	---	---	---	2.34	7.55	8.53	0.62	2.33	2.81	2.8	10.3	12.5	98	3.24	C	A	3.83	3.95	1446	0.74
	2.0+5.0	2.44	6.09	---	---	---	2.57	8.53	9.09	0.63	2.45	2.66	2.8	10.9	11.8	98	3.48	B	A	3.84	3.87	1412	0.73
	2.0+6.0	2.32	6.95	---	---	---	2.86	9.27	9.88	0.65	2.63	2.96	2.9	11.7	13.1	98	3.52	B	A	3.85	4.42	1606	0.87
	2.0+7.1	2.20	7.83	---	---	---	3.17	10.03	10.37	0.69	3.01	3.18	3.1	13.4	14.1	98	3.33	C	A	3.88	4.66	1684	0.90
	2.5+2.5	3.04	3.04	---	---	---	1.98	6.08	7.46	0.47	1.76	2.35	2.1	7.8	10.4	98	3.45	B	A	3.84	3.60	1312	0.67
	2.5+3.5	3.05	4.26	---	---	---	2.28	7.31	8.53	0.60	2.34	2.94	2.7	10.4	13.0	98	3.12	D	A	3.87	3.96	1434	0.75
	2.5+4.2	3.04	5.12	---	---	---	2.49	8.16	9.02	0.65	2.76	3.18	2.9	12.2	14.1	98	2.96	D	A	3.82	4.00	1465	0.72
	2.5+5.0	2.98	5.95	---	---	---	2.72	8.93	9.70	0.66	2.61	2.99	2.9	11.6	13.3	98	3.42	B	A	3.83	3.92	1435	0.71
	2.5+6.0	2.83	6.79	---	---	---	3.00	9.62	9.88	0.67	2.86	3.03	3.0	12.7	13.4	98	3.36	C	A	3.85	4.48	1629	0.86
	2.5+7.1	2.70	7.68	---	---	---	3.31	10.38	10.77	0.72	3.22	3.46	3.2	14.3	15.4	98	3.22	C	A	3.89	4.73	1701	0.91
	3.5+3.5	4.27	4.27	---	---	---	2.57	8.54	9.02	0.65	2.91	3.15	2.9	12.9	14.0	98	2.93	D	A	3.84	4.42	1610	0.87
	3.5+4.2	4.12	4.94	---	---	---	2.77	9.06	9.60	0.70	3.21	3.53	3.1	14.2	15.7	98	2.82	D	A	3.84	4.47	1630	0.85
	3.5+5.0	3.96	5.66	---	---	---	3.00	9.62	9.70	0.71	2.93	2.98	3.1	13.0	13.2	98	3.28	C	A	3.83	4.36	1595	0.81
	3.5+6.0	3.80	6.51	---	---	---	3.28	10.31	10.75	0.72	3.19	3.43	3.2	14.2	15.2	98	3.23	C	A	3.87	5.06	1830	0.97
	3.5+7.1	3.43	6.97	---	---	---	3.59	10.40	10.78	0.77	3.11	3.35	3.4	13.8	14.9	98	3.34	C	A	3.91	5.35	1917	1.00
	4.2+4.2	4.77	4.77	---	---	---	2.97	9.54	9.61	0.72	3.47	3.53	3.2	15.4	15.7	98	2.75	E	A	3.85	4.52	1644	0.83
	4.2+5.0	4.61	5.49	---	---	---	3.20	10.10	10.12	0.73	3.22	3.28	3.2	14.3	14.6	98	3.14	D	A	3.84	4.41	1607	0.86
	4.2+6.0	4.28	6.12	---	---	---	3.48	10.40	10.76	0.75	3.24	3.42	3.3	14.4	15.2	98	3.21	C	A	3.89	5.12	1845	0.97
	4.2+7.1	3.87	6.53	---	---	---	3.79	10.40	10.78	0.79	3.11	3.34	3.5	13.8	14.8	98	3.34	C	A	3.91	5.41	1940	1.00
	5.0+5.0	5.20	5.20	---	---	---	3.42	10.40	10.64	0.76	3.28	3.40	3.4	14.6	15.1	98	3.17	D	A	3.84	4.31	1573	0.82
	5.0+6.0	4.73	5.67	---	---	---	3.70	10.40	10.88	0.75	3.08	3.31	3.3	13.7	14.7	98	3.38	C	A	3.87	4.99	1806	0.97
	5.0+7.1	4.30	6.10	---	---	---	4.01	10.40	10.51	0.83	3.01	3.06	3.7	13.4	13.6	98	3.46	B	A	3.89	5.28	1900	1.00
	6.0+6.0	5.20	5.20	---	---	---	3.99	10.40	10.71	0.76	2.88	3.04	3.4	12.8	13.5	98	3.61	A	A	3.92	5.83	2080	1.10
	6.0+7.1	4.76	5.64	---	---	---	4.30	10.40	10.74	0.84	2.86	3.03	3.7	12.7	13.4	98	3.64	A	A	3.95	6.17	2187	1.20
	7.1+7.1	5.20	5.20	---	---	---	4.61	10.40	10.77	0.89	2.85	3.02	3.9	12.6	13.4	98	3.65	A	A	3.95	6.46	2289	1.26
	1.5+1.5+1.5	1.83	1.83	1.83	---	---	1.84	5.50	7.52	0.47	1.24	1.92	2.1	5.5	8.5	98	4.44	A	A	3.85	4.40	1599	0.85
	1.5+1.5+2.0	1.83	1.83	2.44	---	---	1.98	6.10	7.52	0.49	1.39	1.92	2.2	6.2	8.5	98	4.39	A	A	3.84	4.52	1648	0.83
	1.5+1.5+2.5	1.83	1.83	3.05	---	---	2.13	6.71	7.52	0.51	1.63	1.92	2.3	7.2	8.5	98	4.12	A	A	3.85	4.58	1667	0.89
	1.5+1.5+3.5	1.83	1.83	4.27	---	---	2.43	7.93	9.22	0.55	2.04	2.57	2.4	9.1	11.4	98	3.89	A	A	3.87	5.18	1874	0.96
	1.5+1.5+4.2	1.82	1.82	5.09	---	---	2.63	8.73	9.22	0.60	2.37	2.57	2.7	10.5	11.4	98	3.68	A	A	3.88	5.24	1890	1.02
	1.5+1.5+5.0	1.74	1.74	5.80	---	---	2.86	9.28	9.99	0.60	2.53	2.84	2.7	11.2	12.6	98	3.67	A	A	3.88	5.11	1842	0.96
1.5+1.5+6.0	1.66	1.66	6.65	---	---	3.14	9.97	10.71	0.61	2.65	3.04	2.7	11.8	13.5	98	3.76	A	A	3.90	5.97	2143	1.12	
1.5+1.5+7.1	1.55	1.55	7.32	---	---	3.45	10.41	10.75	0.65	2.86	3.03	2.9	12.7	13.4	98	3.64	A	A	3.93	6.32	2252	1.23	
1.5+2.0+2.0	1.83	2.44	2.44	---	---	2.13	6.71	7.52	0.51	1.63	1.92	2.3	7.2	8.5	98	4.12	A	A	3.85	4.65	1693	0.89	
1.5+2.0+2.5	1.83	2.44	3.05	---	---	2.28	7.32	8.67	0.53	1.83	2.32	2.4	8.1	10.3	98	4.00	A	A	3.85	4.72	1718	0.90	
1.5+2.0+3.5	1.83	2.44	4.27	---	---	2.58	8.54	9.22	0.57	2.27	2.57	2.5	10.1	11.4	98	3.76	A	A	3.87	5.34	1931	0.99	
1.5+2.0+4.2	1.77	2.36	4.95	---	---	2.77	9.07	9.89	0.62	2.47	2.89	2.8	11.0	12.8	98	3.67	A	A	3.90	5.40	1937	1.05	
1.5+2.0+5.0	1.70	2.27	5.66	---	---	3.00	9.63	9.99	0.62	2.68	2.84	2.8	11.9	12.6	98	3.59	B	A	3.87	5.27	1906	0.99	
1.5+2.0+6.0	1.63	2.17	6.52	---	---	3.28	10.32	10.71	0.64	2.82	3.04	2.8	12.5	13.5	98	3.66	A	A	3.94	6.16	2189	1.19	
1.5+2.0+7.1	1.47	1.96	6.97	---	---	3.59	10.41	10.75	0.68	2.86	3.03	3.0	12.7	13.4	98	3.64	A	A	3.94	6.46	2297	1.26	
1.5+2.5+2.5	1.83	3.05	3.05	---	---	2.43	7.93	9.21	0.55	2.05	2.58	2.4	9.1	11.4	98	3.87	A	A	3.86	4.78	1734	0.89	
1.5+2.5+3.5	1.79	2.98	4.17	---	---	2.72	8.94	9.89	0.60	2.42	2.89	2.7	10.7	12.8	98	3.69	A	A	3.89	5.42	1951	1.01	
1.5+2.5+4.2	1.72	2.87	4.82	---	---	2.91	9.42	9.89	0.64	2.62	2.89	2.8	11.6	12.8	98	3.60	B	A	3.90	5.48	1967	1.07	
1.5+2.5+5.0	1.66	2.77	5.54	---	---	3.14	9.97	10.48	0.65	2.84	3.07	2.9	12.6	13.6	98	3.51	B	A	3.87	5.34	1931	0.99	
1.5+2.5+6.0	1.56	2.60	6.25	---	---	3.42	10.41	10.71	0.66	2.87	3.04	2.9	12.7	13.5	98	3.63	A	A	3.92	6.25	2233	1.16	
1.5+2.5+7.1	1.41	2.34	6.66	---	---	3.73	10.41	10.75	0.70	2.86	3.03	3.1	12.7	13.4	98	3.64	A	A	3.94	6.46	2298	1.26	
1.5+3.5+3.5	1.70	3.97	3.97	---	---	3.00	9.63	9.89	0.64	2.73	2.89	2.8	12.1	12.8	98	3.53	B	A	3.93	6.16	2193	1.19	
1.5+3.5+4.2	1.65	3.85	4.62	---	---	3.20	10.11	10.37	0.69	3.01	3.12	3.1	13.4	13.8	98	3.36	C	A	3.92	6.23	2224	1.20	
1.5+3.5+5.0	1.56	3.64	5.21	---	---	3.42	10.41	10.49	0.70	3.07	3.07	3.1	13.6	13.6	98	3.39	C	A	3.94	6.07	2157	1.16	
1.5+3.5+6.0	1.42	3.31	5.68	---	---	3.70	10.41	10.72	0.71	2.87	3.04	3.1	12.7	13.5	98	3.63	A	A	3.97	6.46	2280	1.2	

Combination tables

Heating

Outdoor unit	Indoor unit	Heating capacity (kW)					Total capacity (kW)			Power input (kW)			Total current (A)			Power factor (%)	COP	Energy label	Seasonal data				
		A room	B room	C room	D room	E room	Min.	Nom.	Max.	Min.	Nom.	Max.	Min.	Nom.	Max.				Label	SCOP	Pdesign	AEC	Back-up heater capacity at -10°C
5MXS90E	2.0+2.5+7.1	1.79	2.24	6.37	---	---	3.87	10.40	10.75	0.73	2.86	3.03	3.2	12.7	13.4	98	3.64	A	A	3.97	6.46	2278	1.25
	2.0+3.5+3.5	2.22	3.87	3.87	---	---	3.14	9.96	10.36	0.69	2.89	3.12	3.1	12.8	13.8	98	3.45	B	A	3.91	6.35	2273	1.21
	2.0+3.5+4.2	2.14	3.75	4.51	---	---	3.34	10.40	10.55	0.72	3.18	3.23	3.2	14.1	14.3	98	3.27	C	A	3.93	6.43	2293	1.23
	2.0+3.5+5.0	1.98	3.47	4.95	---	---	3.56	10.40	10.90	0.72	3.07	3.30	3.2	13.6	14.6	98	3.39	C	A	3.91	6.26	2240	1.17
	2.0+3.5+6.0	1.80	3.17	5.43	---	---	3.84	10.40	10.72	0.73	2.87	3.04	3.2	12.7	13.5	98	3.62	A	A+	4.02	6.46	2248	1.25
	2.0+3.5+7.1	1.65	2.89	5.86	---	---	4.15	10.40	10.75	0.81	2.86	3.03	3.6	12.7	13.4	98	3.64	A	A+	4.04	6.46	2241	1.25
	2.0+4.2+4.2	2.00	4.20	4.20	---	---	3.53	10.40	10.56	0.74	3.12	3.23	3.3	13.8	14.3	98	3.33	C	A	3.93	6.46	2301	1.26
	2.0+4.2+5.0	1.86	3.90	4.64	---	---	3.76	10.40	10.91	0.77	3.07	3.30	3.4	13.6	14.6	98	3.39	C	A	3.91	6.34	2270	1.20
	2.0+4.2+6.0	1.70	3.58	5.12	---	---	4.04	10.40	10.73	0.78	2.87	3.04	3.5	12.7	13.5	98	3.62	A	A+	4.03	6.46	2246	1.25
	2.0+4.2+7.1	1.56	3.28	5.56	---	---	4.35	10.40	10.76	0.83	2.86	3.02	3.7	12.7	13.4	98	3.64	A	A+	4.06	6.46	2228	1.25
	2.0+5.0+5.0	1.74	4.33	4.33	---	---	3.99	10.40	10.63	0.80	2.96	3.08	3.5	13.1	13.7	98	3.51	B	A	3.94	6.17	2194	1.20
	2.0+5.0+6.0	1.60	4.00	4.80	---	---	4.27	10.40	10.86	0.79	2.77	2.99	3.5	12.3	13.3	98	3.75	A	A	3.99	6.46	2267	1.25
	2.0+5.0+7.1	1.47	3.69	5.24	---	---	4.58	10.40	10.89	0.86	2.75	2.97	3.8	12.2	13.2	98	3.78	A	A+	4.04	6.46	2240	1.25
	2.0+6.0+6.0	1.48	4.46	4.46	---	---	4.55	10.40	11.09	0.82	2.62	2.90	3.6	11.6	12.9	98	3.97	A	A+	4.09	6.46	2209	1.24
	2.0+6.0+7.1	1.38	4.13	4.89	---	---	4.86	10.40	11.12	0.87	2.61	2.89	3.9	11.6	12.8	98	3.98	A	A+	4.12	6.46	2194	1.24
	2.5+2.5+2.5	2.98	2.98	2.98	---	---	2.72	8.94	9.88	0.60	2.42	2.89	2.7	10.7	12.8	98	3.69	A	A	3.87	5.00	1810	0.98
	2.5+2.5+3.5	2.83	2.83	3.96	---	---	3.00	9.62	9.89	0.67	2.73	2.89	3.0	12.1	12.8	98	3.52	B	A	3.89	5.67	2043	1.07
	2.5+2.5+4.2	2.74	2.74	4.62	---	---	3.20	10.10	10.36	0.69	3.01	3.12	3.1	13.4	13.8	98	3.36	C	A	3.91	5.74	2056	1.08
	2.5+2.5+5.0	2.60	2.60	5.20	---	---	3.42	10.40	10.89	0.70	3.07	3.30	3.1	13.6	14.6	98	3.39	C	A	3.89	5.59	2014	1.05
	2.5+2.5+6.0	2.36	2.36	5.68	---	---	3.70	10.40	10.71	0.71	2.87	3.04	3.1	12.7	13.5	98	3.62	A	A	3.94	6.46	2297	1.26
	2.5+2.5+7.1	2.15	2.15	6.10	---	---	4.01	10.40	10.75	0.78	2.86	3.03	3.5	12.7	13.4	98	3.64	A	A	3.97	6.46	2277	1.25
	2.5+3.5+3.5	2.71	3.80	3.80	---	---	3.28	10.31	10.76	0.72	3.12	3.35	3.2	13.8	14.9	98	3.30	C	A	3.93	6.44	2296	1.24
	2.5+3.5+4.2	2.55	3.57	4.28	---	---	3.48	10.40	10.77	0.74	3.18	3.35	3.3	14.1	14.9	98	3.27	C	A	3.93	6.46	2301	1.26
	2.5+3.5+5.0	2.36	3.31	4.73	---	---	3.70	10.40	10.90	0.75	3.07	3.30	3.3	13.6	14.6	98	3.39	C	A	3.91	6.35	2273	1.21
	2.5+3.5+6.0	2.17	3.03	5.20	---	---	3.99	10.40	10.72	0.76	2.87	3.04	3.4	12.7	13.5	98	3.62	A	A+	4.03	6.46	2246	1.25
	2.5+3.5+7.1	1.98	2.78	5.64	---	---	4.30	10.40	10.75	0.83	2.86	3.03	3.7	12.7	13.4	98	3.64	A	A+	4.06	6.46	2226	1.25
	2.5+4.2+4.2	2.38	4.01	4.01	---	---	3.68	10.40	10.77	0.77	3.12	3.35	3.4	13.8	14.9	98	3.33	C	A	3.93	6.46	2302	1.26
	2.5+4.2+5.0	2.23	3.73	4.44	---	---	3.90	10.40	10.91	0.80	3.07	3.30	3.5	13.6	14.6	98	3.39	C	A	3.93	6.43	2293	1.23
	2.5+4.2+6.0	2.05	3.44	4.91	---	---	4.18	10.40	10.73	0.81	2.87	3.04	3.6	12.7	13.5	98	3.62	A	A+	4.03	6.46	2245	1.25
	2.5+4.2+7.1	1.88	3.17	5.35	---	---	4.49	10.40	10.76	0.86	2.86	3.02	3.8	12.7	13.4	98	3.64	A	A+	4.06	6.46	2226	1.25
	2.5+5.0+5.0	2.08	4.16	4.16	---	---	4.13	10.40	10.63	0.83	2.96	3.08	3.7	13.1	13.7	98	3.51	B	A	3.91	6.26	2240	1.17
	2.5+5.0+6.0	1.93	3.85	4.62	---	---	4.41	10.40	10.86	0.84	2.77	2.99	3.7	12.3	13.3	98	3.75	A	A+	4.02	6.46	2248	1.25
	2.5+5.0+7.1	1.78	3.56	5.06	---	---	4.72	10.40	10.89	0.89	2.75	2.97	3.9	12.2	13.2	98	3.78	A	A+	4.04	6.46	2241	1.25
	2.5+6.0+6.0	1.80	4.30	4.30	---	---	4.69	10.40	11.09	0.85	2.62	2.90	3.8	11.6	12.9	98	3.97	A	A+	4.10	6.46	2204	1.24
	2.5+6.0+7.1	1.67	4.00	4.73	---	---	5.00	10.40	11.12	0.90	2.61	2.89	4.0	11.6	12.8	98	3.98	A	A+	4.15	6.46	2181	1.24
	3.5+3.5+3.5	3.46	3.46	3.46	---	---	3.56	10.38	10.76	0.77	3.12	3.35	3.4	13.8	14.9	98	3.33	C	A+	4.02	6.46	2252	1.25
	3.5+3.5+4.2	3.25	3.25	3.90	---	---	3.76	10.40	10.77	0.80	3.12	3.35	3.5	13.8	14.9	98	3.33	C	A+	4.02	6.46	2250	1.25
	3.5+3.5+5.0	3.03	3.03	4.34	---	---	3.99	10.40	10.91	0.83	3.07	3.30	3.7	13.6	14.6	98	3.39	C	A	3.98	6.46	2271	1.25
	3.5+3.5+6.0	2.80	2.80	4.80	---	---	4.27	10.40	10.73	0.84	2.87	3.04	3.7	12.7	13.5	98	3.62	A	A+	4.09	6.46	2213	1.24
	3.5+3.5+7.1	2.58	2.58	5.24	---	---	4.58	10.40	10.76	0.89	2.86	3.02	3.9	12.7	13.4	98	3.64	A	A+	4.12	6.46	2198	1.24
	3.5+4.2+4.2	3.06	3.67	3.67	---	---	3.96	10.40	10.78	0.85	3.11	3.34	3.8	13.8	14.8	98	3.34	C	A+	4.02	6.46	2248	1.25
	3.5+4.2+5.0	2.87	3.44	4.09	---	---	4.18	10.40	10.51	0.85	3.01	3.12	3.8	13.4	13.8	98	3.46	B	A+	4.02	6.46	2252	1.25
	3.5+4.2+6.0	2.66	3.19	4.55	---	---	4.46	10.40	10.74	0.87	2.87	3.03	3.9	12.7	13.4	98	3.62	A	A+	4.09	6.46	2213	1.24
	3.5+4.2+7.1	2.46	2.95	4.99	---	---	4.78	10.40	10.77	0.95	2.85	3.02	4.2	12.6	13.4	98	3.65	A	A+	4.14	6.46	2185	1.24
	3.5+5.0+5.0	2.70	3.85	3.85	---	---	4.41	10.40	10.64	0.89	2.96	3.07	3.9	13.1	13.6	98	3.51	B	A	3.96	6.46	2284	1.25
	3.5+5.0+6.0	2.51	3.59	4.30	---	---	4.69	10.40	10.86	0.90	2.76	2.98	4.0	12.2	13.2	98	3.77	A	A+	4.06	6.46	2228	1.24
	3.5+5.0+7.1	2.34	3.33	4.73	---	---	5.00	10.40	10.90	0.95	2.75	2.97	4.2	12.2	13.2	98	3.78	A	A+	4.10	6.46	2207	1.24
	3.5+6.0+6.0	2.34	4.03	4.03	---	---	4.97	10.40	11.09	0.91	2.62	2.90	4.0	11.6	12.9	98	3.97	A	A+	4.21	6.46	2150	1.23
	4.2+4.2+4.2	3.47	3.47	3.47	---	---	4.15	10.40	10.79	0.88	3.11	3.34	3.9	13.8	14.8	98	3.34	C	A+	4.02	6.46	2249	1.25
	4.2+4.2+5.0	3.26	3.26	3.88	---	---	4.38	10.40	10.52	0.91	3.00	3.12	4.0	13.3	13.8	98	3.47	B	A+	4.02	6.46	2250	1.25
4.2+4.2+6.0	3.03	3.03	4.34	---	---	4.66	10.40	10.75	0.92	2.86	3.03	4.1	12.7	13.4	98	3.64	A	A+	4.10	6.46	2208	1.24	
4.2+4.2+7.1	2.82	2.82	4.76	---	---	4.97	10.40	10.78	0.98	2.85	3.02	4.3	12.6	13.4	98	3.65	A	A+	4.16	6.46	2172	1.24	
4.2+5.0+5.0	3.08	3.66	3.66	---	---	4.61	10.40	10.64	0.91	2.96	3.07	4.0	13.1	13.6	98	3.51	B	A	3.98	6.46	2271	1.25	
4.2+5.0+6.0	2.87	3.42	4.11	---	---	4.89	10.40	10.87	0.93	2.76	2.98	4.1	12.2	13.2	98	3.77	A	A+	4.09	6.46	2213	1.24	
5.0+5.0+5.0	3.46	3.46	3.46	---	---	4.83	10.38	10.77	0.95	2.85	3.02	4.2	12.6	13.4	98	3.64	A	A	3.96	6.46	2283	1.25	
15+15+15+15	1.83	1.83	1.83	1.83	---	2.28	7.32	8.82	0.46	1.72	2.24	2.0	7.6	9.9	98	4.26	A	A	3.98	6.12	2156	1.33	
15+15+15+2.0	1.83	1.83	1.83	2.44	---	2.43	7.93	9.42	0.48	1.93	2.44	2.1	8.6	10.8	98	4.11	A	A	3.93	6.31	2248	1.22	
15+15+15+2.5	1.83	1.83	1.83	3.05	---	2.58	8.54	9.42	0.50	2.10	2.44	2.2	9.3	10.8	98	4.07	A	A	3.95	6.41	2273	1.32	
15+15+15+3.5	1.74	1.74	1.74	4.06	---	2.86	9.28	10.19	0.54	2.39	2.75	2.4	10.6	12.2	98	3.88	A	A+	4.01	6.46	2258	1.25	

Combination tables

Heating

Outdoor unit	Indoor unit	Heating capacity (kW)					Total capacity (kW)			Power input (kW)			Total current (A)			Power factor (%)	COP	Energy label	Seasonal data				
		A room	B room	C room	D room	E room	Min.	Nom.	Max.	Min.	Nom.	Max.	Min.	Nom.	Max.				Label	SCOP	Pdesign	AEC	Back-up heater capacity at -10°C
5MXS90E	15+15+42+60	1.18	1.18	3.31	4.73	---	4.32	10.41	11.11	0.77	2.61	2.89	3.4	11.6	12.8	98	3.99	A	A+	4.20	6.46	2152	1.23
	15+15+42+71	1.09	1.09	3.06	5.17	---	4.63	10.41	11.14	0.81	2.60	2.88	3.6	11.5	12.8	98	4.00	A	A+	4.25	6.46	2131	1.23
	15+15+50+50	1.20	1.20	4.00	4.00	---	4.27	10.41	11.01	0.76	2.71	2.93	3.4	12.0	13.0	98	3.84	A	A+	4.09	6.46	2212	1.24
	15+15+50+60	1.12	1.12	3.72	4.46	---	4.55	10.41	11.23	0.77	2.56	2.90	3.4	11.4	12.9	98	4.07	A	A+	4.20	6.46	2156	1.23
	15+15+50+71	1.03	1.03	3.45	4.89	---	4.86	10.41	11.27	0.84	2.50	2.88	3.7	11.1	12.8	98	4.16	A	A+	4.22	6.46	2146	1.23
	15+15+60+60	1.04	1.04	4.16	4.16	---	4.83	10.41	11.46	0.80	2.43	2.81	3.5	10.8	12.5	98	4.28	A	A+	4.30	6.46	2103	1.22
	15+20+20+20	1.79	2.38	2.38	2.38	---	2.72	8.94	10.18	0.52	2.24	2.76	2.3	9.9	12.2	98	3.99	A	A	3.96	6.46	2284	1.26
	15+20+20+25	1.74	2.32	2.32	2.90	---	2.86	9.28	10.18	0.57	2.39	2.76	2.5	10.6	12.2	98	3.88	A	A	3.97	6.46	2279	1.25
	15+20+20+35	1.66	2.22	2.22	3.88	---	3.14	9.97	10.73	0.61	2.65	3.04	2.7	11.8	13.5	98	3.76	A	A+	4.06	6.46	2226	1.25
	15+20+20+42	1.61	2.15	2.15	4.51	---	3.34	10.41	10.74	0.63	2.87	3.03	2.8	12.7	13.4	98	3.63	A	A+	4.06	6.46	2226	1.25
	15+20+20+50	1.49	1.98	1.98	4.96	---	3.56	10.41	10.86	0.66	2.76	2.98	2.9	12.2	13.2	98	3.77	A	A+	4.04	6.46	2241	1.25
	15+20+20+60	1.36	1.81	1.81	5.43	---	3.84	10.41	11.09	0.67	2.62	2.90	3.0	11.6	12.9	98	3.97	A	A+	4.15	6.46	2181	1.24
	15+20+20+71	1.24	1.65	1.65	5.87	---	4.15	10.41	11.12	0.71	2.61	2.88	3.1	11.6	12.8	98	3.99	A	A+	4.17	6.46	2169	1.24
	15+20+25+25	1.70	2.27	2.83	2.83	---	3.00	9.63	10.18	0.59	2.54	2.76	2.6	11.3	12.2	98	3.79	A	A	3.97	6.46	2278	1.25
	15+20+25+35	1.63	2.17	2.72	3.80	---	3.28	10.32	10.73	0.63	2.81	3.04	2.8	12.5	13.5	98	3.67	A	A+	4.06	6.46	2226	1.25
	15+20+25+42	1.53	2.04	2.55	4.29	---	3.48	10.41	10.74	0.66	2.87	3.03	2.9	12.7	13.4	98	3.63	A	A+	4.07	6.46	2224	1.25
	15+20+25+50	1.42	1.89	2.37	4.73	---	3.70	10.41	10.86	0.68	2.76	2.98	3.0	12.2	13.2	98	3.77	A	A+	4.06	6.46	2226	1.25
	15+20+25+60	1.30	1.74	2.17	5.21	---	3.99	10.41	11.09	0.69	2.62	2.90	3.1	11.6	12.9	98	3.97	A	A+	4.15	6.46	2181	1.24
	15+20+25+71	1.19	1.59	1.99	5.64	---	4.30	10.41	11.12	0.74	2.61	2.88	3.3	11.6	12.8	98	3.99	A	A+	4.20	6.46	2154	1.23
	15+20+35+35	1.49	1.98	3.47	3.47	---	3.56	10.41	10.74	0.68	2.87	3.03	3.0	12.7	13.4	98	3.63	A	A+	4.14	6.46	2184	1.24
	15+20+35+42	1.39	1.86	3.25	3.90	---	3.76	10.41	10.74	0.73	2.86	3.03	3.2	12.7	13.4	98	3.64	A	A+	4.14	6.46	2184	1.24
	15+20+35+50	1.30	1.74	3.04	4.34	---	3.99	10.41	10.87	0.73	2.76	2.98	3.2	12.2	13.2	98	3.77	A	A+	4.11	6.46	2200	1.24
	15+20+35+60	1.20	1.60	2.80	4.80	---	4.27	10.41	11.10	0.74	2.61	2.89	3.3	11.6	12.8	98	3.99	A	A+	4.21	6.46	2148	1.23
	15+20+35+71	1.11	1.48	2.58	5.24	---	4.58	10.41	11.13	0.81	2.60	2.88	3.6	11.5	12.8	98	4.00	A	A+	4.27	6.46	2121	1.23
	15+20+42+42	1.31	1.75	3.67	3.67	---	3.96	10.41	10.75	0.75	2.86	3.03	3.3	12.7	13.4	98	3.64	A	A+	4.14	6.46	2185	1.24
	15+20+42+50	1.23	1.64	3.44	4.10	---	4.18	10.41	10.88	0.78	2.76	2.98	3.5	12.2	13.2	98	3.77	A	A+	4.14	6.46	2184	1.24
	15+20+42+60	1.14	1.52	3.19	4.56	---	4.46	10.41	11.11	0.79	2.61	2.89	3.5	11.6	12.8	98	3.99	A	A+	4.22	6.46	2146	1.23
	15+20+42+71	1.06	1.41	2.95	4.99	---	4.78	10.41	11.14	0.84	2.60	2.88	3.7	11.5	12.8	98	4.00	A	A+	4.27	6.46	2119	1.23
	15+20+50+50	1.16	1.54	3.86	3.86	---	4.41	10.41	11.01	0.79	2.71	2.93	3.5	12.0	13.0	98	3.84	A	A+	4.10	6.46	2204	1.24
	15+20+50+60	1.08	1.44	3.59	4.31	---	4.69	10.41	11.23	0.82	2.56	2.90	3.6	11.4	12.9	98	4.07	A	A+	4.20	6.46	2152	1.23
	15+20+50+71	1.00	1.33	3.34	4.74	---	5.00	10.41	11.27	0.87	2.50	2.88	3.9	11.1	12.8	98	4.16	A	A+	4.25	6.46	2131	1.23
	15+20+60+60	1.01	1.34	4.03	4.03	---	4.97	10.41	11.46	0.83	2.43	2.81	3.7	10.8	12.5	98	4.28	A	A+	4.31	6.46	2098	1.22
	15+25+25+25	1.66	2.77	2.77	2.77	---	3.14	9.97	10.72	0.61	2.65	3.04	2.7	11.8	13.5	98	3.76	A	A+	4.00	6.46	2259	1.25
	15+25+25+35	1.56	2.60	2.60	3.64	---	3.42	10.41	10.73	0.66	2.87	3.04	2.9	12.7	13.5	98	3.63	A	A+	4.07	6.46	2224	1.25
	15+25+25+42	1.46	2.43	2.43	4.09	---	3.62	10.41	10.74	0.68	2.87	3.03	3.0	12.7	13.4	98	3.63	A	A+	4.07	6.46	2222	1.24
	15+25+25+50	1.36	2.26	2.26	4.53	---	3.84	10.41	10.86	0.71	2.76	2.98	3.1	12.2	13.2	98	3.77	A	A+	4.07	6.46	2224	1.25
	15+25+25+60	1.25	2.08	2.08	5.00	---	4.13	10.41	11.09	0.72	2.62	2.90	3.2	11.6	12.9	98	3.97	A	A+	4.15	6.46	2181	1.24
	15+25+25+71	1.15	1.91	1.91	5.43	---	4.44	10.41	11.12	0.79	2.61	2.88	3.5	11.6	12.8	98	3.99	A	A+	4.20	6.46	2152	1.23
	15+25+35+35	1.42	2.37	3.31	3.31	---	3.70	10.41	10.74	0.71	2.87	3.03	3.1	12.7	13.4	98	3.63	A	A+	4.14	6.46	2184	1.24
	15+25+35+42	1.33	2.22	3.11	3.74	---	3.90	10.41	10.74	0.76	2.86	3.03	3.4	12.7	13.4	98	3.64	A	A+	4.14	6.46	2185	1.24
	15+25+35+50	1.25	2.08	2.91	4.16	---	4.13	10.41	10.87	0.76	2.76	2.98	3.4	12.2	13.2	98	3.77	A	A+	4.14	6.46	2184	1.24
	15+25+35+60	1.16	1.93	2.70	4.63	---	4.41	10.41	11.10	0.77	2.61	2.89	3.4	11.6	12.8	98	3.99	A	A+	4.22	6.46	2146	1.23
	15+25+35+71	1.07	1.78	2.50	5.06	---	4.72	10.41	11.13	0.84	2.60	2.88	3.7	11.5	12.8	98	4.00	A	A+	4.27	6.46	2119	1.23
	15+25+42+42	1.26	2.10	3.53	3.53	---	4.10	10.41	10.75	0.78	2.86	3.03	3.5	12.7	13.4	98	3.64	A	A+	4.16	6.46	2173	1.24
	15+25+42+50	1.18	1.97	3.31	3.94	---	4.32	10.41	10.88	0.81	2.76	2.98	3.6	12.2	13.2	98	3.77	A	A+	4.14	6.46	2184	1.24
	15+25+42+60	1.10	1.83	3.08	4.40	---	4.61	10.41	11.11	0.82	2.61	2.89	3.6	11.6	12.8	98	3.99	A	A+	4.24	6.46	2133	1.23
	15+25+42+71	1.02	1.70	2.86	4.83	---	4.92	10.41	11.14	0.90	2.60	2.88	4.0	11.5	12.8	98	4.00	A	A+	4.27	6.46	2119	1.23
	15+25+50+50	1.12	1.86	3.72	3.72	---	4.10	10.41	10.75	0.78	2.86	3.03	3.5	12.7	13.4	98	3.64	A	A+	4.11	6.46	2200	1.24
	15+25+50+60	1.04	1.74	3.47	4.16	---	4.32	10.41	10.88	0.81	2.76	2.98	3.6	12.2	13.2	98	3.77	A	A+	4.21	6.46	2148	1.23
	15+25+50+71	1.30	3.04	3.04	3.04	---	3.99	10.41	10.74	0.76	2.86	3.03	3.4	12.7	13.4	98	3.64	A	A+	4.20	6.46	2152	1.23
15+35+35+42	1.23	2.87	2.87	3.44	---	4.18	10.41	10.75	0.81	2.86	3.03	3.6	12.7	13.4	98	3.64	A	A+	4.21	6.46	2150	1.23	
15+35+35+50	1.16	2.70	2.70	3.86	---	4.41	10.41	10.88	0.84	2.76	2.98	3.7	12.2	13.2	98	3.77	A	A+	4.19	6.46	2157	1.23	
15+35+35+60	1.08	2.51	2.51	4.31	---	4.69	10.41	11.11	0.85	2.61	2.89	3.8	11.6	12.8	98	3.99	A	A+	4.30	6.46	2102	1.22	
15+35+35+71	1.00	2.34	2.34	4.74	---	5.00	10.41	11.14	0.90	2.60	2.88	4.0	11.5	12.8	98	4.00	A	A+	4.33	6.46	2088	1.22	
15+35+42+42	1.17	2.72	3.26	3.26	---	4.38	10.41	10.76	0.83	2.86	3.02	3.7	12.7	13.4	98	3.64	A	A+	4.23	6.46	2136	1.23	
15+35+42+50	1.10	2.57	3.08	3.67	---	4.61	10.41	10.89	0.86	2.75	2.98	3.8	12.2	13.2	98	3.79	A	A+	4.20	6.46	2152	1.23	
15+35+42+60	1.03	2.40	2.88	4.11	---	4.89	10.41	11.12	0.87	2.61	2.89	3.9	11.6	12.8	98	3.99	A	A+	4.30	6.46	2102	1.22	
15+35+50+50	1.04	2.43	3.47	3.47	---	4.83	10.41	11.01	0.90	2.71	2.93	4.0	12.0	13.0	98	3.84	A	A+	4.20	6.46			

Combination tables

Heating

Outdoor unit	Indoor unit	Heating capacity (kW)					Total capacity (kW)			Power input (kW)			Total current (A)			Power factor (%)	COP	Energy label	Seasonal data				
		A room	B room	C room	D room	E room	Min.	Nom.	Max.	Min.	Nom.	Max.	Min.	Nom.	Max.				Label	SCOP	Pdesign	AEC	Back-up heater capacity at -10°C
5MXS90E	20+20+50+60	1.39	1.39	3.47	4.15	---	4.83	10.40	11.23	0.85	2.51	2.90	3.8	11.1	12.9	98	4.14	A	A+	4.24	6.46	2133	1.23
	20+25+25+25	2.18	2.71	2.71	2.71	---	3.28	10.31	10.72	0.64	2.82	3.04	2.8	12.5	13.5	98	3.66	A	A+	4.01	6.46	2255	1.25
	20+25+25+35	1.97	2.48	2.48	3.47	---	3.56	10.40	10.73	0.68	2.87	3.04	3.0	12.7	13.5	98	3.62	A	A+	4.10	6.46	2209	1.24
	20+25+25+42	1.86	2.32	2.32	3.90	---	3.76	10.40	10.74	0.73	2.87	3.03	3.2	12.7	13.4	98	3.62	A	A+	4.10	6.46	2207	1.24
	20+25+25+50	1.73	2.17	2.17	4.33	---	3.99	10.40	10.86	0.73	2.76	2.99	3.2	12.2	13.3	98	3.77	A	A+	4.07	6.46	2222	1.24
	20+25+25+60	1.60	2.00	2.00	4.80	---	4.27	10.40	11.09	0.74	2.62	2.90	3.3	11.6	12.9	98	3.97	A	A+	4.17	6.46	2167	1.24
	20+25+25+71	1.48	1.84	1.84	5.24	---	4.58	10.40	11.12	0.82	2.61	2.88	3.6	11.6	12.8	98	3.98	A	A+	4.21	6.46	2147	1.23
	20+25+25+85	1.80	2.26	3.17	3.17	---	3.84	10.40	10.74	0.73	2.87	3.03	3.2	12.7	13.4	98	3.62	A	A+	4.16	6.46	2173	1.24
	20+25+25+92	1.71	2.13	2.98	3.58	---	4.04	10.40	10.74	0.78	2.86	3.03	3.5	12.7	13.4	98	3.64	A	A+	4.16	6.46	2172	1.24
	20+25+35+50	1.60	2.00	2.80	4.00	---	4.27	10.40	10.87	0.78	2.76	2.98	3.5	12.2	13.2	98	3.77	A	A+	4.14	6.46	2185	1.24
	20+25+35+60	1.48	1.86	2.60	4.46	---	4.55	10.40	11.10	0.82	2.61	2.89	3.6	11.6	12.8	98	3.98	A	A+	4.25	6.46	2131	1.23
	20+25+35+71	1.38	1.72	2.41	4.89	---	4.86	10.40	11.13	0.87	2.60	2.88	3.9	11.5	12.8	98	4.00	A	A+	4.27	6.46	2116	1.22
	20+25+35+84	1.61	2.01	3.39	3.39	---	4.24	10.40	10.75	0.81	2.86	3.03	3.6	12.7	13.4	98	3.64	A	A+	4.17	6.46	2171	1.23
	20+25+42+50	1.52	1.90	3.19	3.79	---	4.46	10.40	10.88	0.84	2.76	2.98	3.7	12.2	13.2	98	3.77	A	A+	4.16	6.46	2173	1.24
	20+25+42+60	1.42	1.77	2.97	4.24	---	4.75	10.40	11.11	0.85	2.61	2.89	3.8	11.6	12.8	98	3.98	A	A+	4.27	6.46	2121	1.23
	20+25+42+80	1.43	1.79	3.59	3.59	---	4.69	10.40	11.01	0.87	2.71	2.93	3.9	12.0	13.0	98	3.84	A	A+	4.14	6.46	2184	1.24
	20+25+42+90	1.34	1.68	3.35	4.03	---	4.97	10.40	11.23	0.88	2.51	2.90	3.9	11.1	12.9	98	4.14	A	A+	4.24	6.46	2133	1.23
	20+25+42+95	1.67	2.91	2.91	2.91	---	4.13	10.40	10.74	0.78	2.86	3.03	3.5	12.7	13.4	98	3.64	A	A+	4.23	6.46	2136	1.23
	20+25+42+98	1.58	2.76	2.76	3.30	---	4.32	10.40	10.75	0.84	2.86	3.03	3.7	12.7	13.4	98	3.64	A	A+	4.24	6.46	2135	1.23
	20+25+42+99	1.49	2.60	2.60	3.71	---	4.55	10.40	10.88	0.87	2.76	2.98	3.9	12.2	13.2	98	3.77	A	A+	4.23	6.46	2136	1.23
	20+25+42+99.5	1.38	2.43	2.43	4.16	---	4.83	10.40	11.11	0.87	2.61	2.89	3.9	11.6	12.8	98	3.98	A	A+	4.31	6.46	2100	1.22
	20+25+42+99.8	1.50	2.62	3.14	3.14	---	4.52	10.40	10.76	0.89	2.86	3.02	3.9	12.7	13.4	98	3.64	A	A+	4.26	6.46	2124	1.23
	20+25+42+99.9	1.41	2.48	2.97	3.54	---	4.75	10.40	10.89	0.89	2.75	2.98	3.9	12.2	13.2	98	3.78	A	A+	4.23	6.46	2136	1.23
	20+25+42+99.95	1.35	2.35	3.35	3.35	---	4.97	10.40	11.01	0.92	2.65	2.93	4.1	11.8	13.0	98	3.92	A	A+	4.20	6.46	2152	1.23
	20+42+42+42	1.43	2.99	2.99	2.99	---	4.72	10.40	10.77	0.92	2.85	3.02	4.1	12.6	13.4	98	3.65	A	A+	4.26	6.46	2123	1.23
	20+42+42+50	1.35	2.84	2.84	3.37	---	4.94	10.40	10.90	0.95	2.75	2.97	4.2	12.2	13.2	98	3.78	A	A+	4.24	6.46	2135	1.23
	25+25+25+25	2.60	2.60	2.60	2.60	---	3.42	10.40	10.72	0.66	2.87	3.04	2.9	12.7	13.5	98	3.62	A	A+	4.01	6.46	2255	1.25
	25+25+25+35	2.36	2.36	2.36	3.32	---	3.70	10.40	10.73	0.71	2.87	3.04	3.1	12.7	13.5	98	3.62	A	A+	4.10	6.46	2207	1.24
	25+25+25+42	2.22	2.22	2.22	3.74	---	3.90	10.40	10.74	0.76	2.87	3.03	3.4	12.7	13.4	98	3.62	A	A+	4.10	6.46	2206	1.24
	25+25+25+50	2.08	2.08	2.08	4.16	---	4.13	10.40	10.86	0.76	2.76	2.99	3.4	12.2	13.3	98	3.77	A	A+	4.10	6.46	2209	1.24
	25+25+25+60	1.93	1.93	1.93	4.61	---	4.41	10.40	11.09	0.77	2.62	2.90	3.4	11.6	12.9	98	3.97	A	A+	4.20	6.46	2154	1.23
	25+25+25+71	1.78	1.78	1.78	5.06	---	4.72	10.40	11.12	0.84	2.61	2.88	3.7	11.6	12.8	98	3.98	A	A+	4.21	6.46	2147	1.23
	25+25+25+85	2.17	2.17	3.03	3.03	---	3.99	10.40	10.74	0.76	2.87	3.03	3.4	12.7	13.4	98	3.62	A	A+	4.17	6.46	2171	1.24
	25+25+25+92	2.05	2.05	2.87	3.43	---	4.18	10.40	10.74	0.81	2.86	3.03	3.6	12.7	13.4	98	3.64	A	A+	4.19	6.46	2157	1.23
	25+25+25+95	1.93	1.93	2.70	3.84	---	4.41	10.40	10.87	0.84	2.76	2.98	3.7	12.2	13.2	98	3.77	A	A+	4.16	6.46	2173	1.24
	25+25+25+96	1.79	1.79	2.51	4.31	---	4.69	10.40	11.10	0.85	2.61	2.89	3.8	11.6	12.8	98	3.98	A	A+	4.27	6.46	2121	1.23
	25+25+25+97.1	1.67	1.67	2.33	4.73	---	5.00	10.40	11.13	0.90	2.60	2.88	4.0	11.5	12.8	98	4.00	A	A+	4.30	6.46	2103	1.22
	25+25+42+42	1.94	1.94	3.26	3.26	---	4.38	10.40	10.75	0.84	2.86	3.03	3.7	12.7	13.4	98	3.64	A	A+	4.20	6.46	2155	1.23
	25+25+42+50	1.83	1.83	3.08	3.66	---	4.61	10.40	10.88	0.87	2.76	2.98	3.9	12.2	13.2	98	3.77	A	A+	4.16	6.46	2172	1.24
	25+25+42+60	1.71	1.71	2.87	4.11	---	4.89	10.40	11.11	0.87	2.61	2.89	3.9	11.6	12.8	98	3.98	A	A+	4.27	6.46	2119	1.23
	25+25+50+50	1.73	1.73	3.47	3.47	---	4.83	10.40	11.01	0.90	2.71	2.93	4.0	12.0	13.0	98	3.84	A	A+	4.14	6.46	2185	1.24
	25+35+35+35	2.00	2.80	2.80	2.80	---	4.27	10.40	10.74	0.84	2.86	3.03	3.7	12.7	13.4	98	3.64	A	A+	4.24	6.46	2135	1.23
	25+35+35+42	1.90	2.66	2.66	3.18	---	4.46	10.40	10.75	0.86	2.86	3.03	3.8	12.7	13.4	98	3.64	A	A+	4.26	6.46	2124	1.23
	25+35+35+50	1.79	2.51	2.51	3.59	---	4.69	10.40	10.88	0.89	2.76	2.98	3.9	12.2	13.2	98	3.77	A	A+	4.23	6.46	2136	1.23
	25+35+35+60	1.67	2.35	2.35	4.03	---	4.97	10.40	11.11	0.90	2.61	2.89	4.0	11.6	12.8	98	3.98	A	A+	4.33	6.46	2090	1.22
	25+35+42+42	1.81	2.53	3.03	3.03	---	4.66	10.40	10.76	0.92	2.86	3.02	4.1	12.7	13.4	98	3.64	A	A+	4.26	6.46	2123	1.23
	25+35+42+50	1.72	2.39	2.87	3.42	---	4.89	10.40	10.89	0.92	2.75	2.98	4.1	12.2	13.2	98	3.78	A	A+	4.24	6.46	2135	1.23
	25+35+42+60	1.73	2.89	2.89	2.89	---	4.86	10.40	10.77	0.95	2.85	3.02	4.2	12.6	13.4	98	3.65	A	A+	4.26	6.46	2123	1.23
	35+35+35+35	2.60	2.60	2.60	2.60	---	4.55	10.40	10.75	0.89	2.86	3.03	3.9	12.7	13.4	98	3.64	A	A+	4.30	6.46	2104	1.22
	35+35+35+42	2.48	2.48	2.48	2.96	---	4.75	10.40	10.76	0.92	2.86	3.02	4.1	12.7	13.4	98	3.64	A	A+	4.32	6.46	2094	1.22
35+35+35+50	2.35	2.35	2.35	3.35	---	4.97	10.40	10.89	0.95	2.76	2.98	4.2	12.2	13.2	98	3.77	A	A+	4.30	6.46	2105	1.22	
35+35+42+42	2.36	2.36	2.84	2.84	---	4.94	10.40	10.77	0.98	2.85	3.02	4.3	12.6	13.4	98	3.65	A	A+	4.32	6.46	2094	1.22	
15H35H35H35H35	1.79	1.79	1.79	1.79	1.79	2.72	8.93	10.48	0.45	2.12	2.68	2.0	9.4	11.9	98	4.21	A	A+	4.12	6.46	2194	1.24	
15H35H35H35H40	1.74	1.74	1.74	1.74	2.32	2.86	9.27	10.48	0.47	2.21	2.68	2.1	9.8	11.9	98	4.19	A	A+	4.13	6.46	2190	1.24	
15H35H35H35H45	1.70	1.70	1.70	1.70	2.83	3.00	9.62	10.48	0.51	2.31	2.68	2.3	10.2	11.9	98	4.16	A	A+	4.16	6.46	2175	1.24	
15H35H35H35H50	1.63	1.63	1.63	1.63	3.80	3.28	10.31	11.11	0.55	2.56	2.89	2.4	11.4	12.8	98	4.03	A	A+	4.24	6.46	2132	1.23	
15H35H35H35H55	1.53	1.53	1.53	1.53	4.28	3.48	10.40	11.11	0.59	2.61	2.89	2.6	11.6	12.8	98	3.98	A	A+	4.24	6.46	2132	1.23	
15H35H35H35H60	1.42	1.42	1.42	1.42	4.73	3.70	10.40	11.24	0.60	2.51	2.90	2.7	11.1										

Combination tables

Heating

Outdoor unit	Indoor unit	Heating capacity (kW)					Total capacity (kW)			Power input (kW)			Total current (A)			Power factor (%)	COP	Energy label	Seasonal data				
		A room	B room	C room	D room	E room	Min.	Nom.	Max.	Min.	Nom.	Max.	Min.	Nom.	Max.				Label	SCOP	Pdesign	AEC	Back-up heater capacity at -10°C
5MXS90E	154504120	1.66	1.66	2.21	2.21	2.21	3.14	9.96	11.10	0.53	2.46	2.89	2.4	10.9	12.8	98	4.05	A	A+	4.19	6.46	2161	1.24
	154504145	1.63	1.63	2.17	2.17	2.17	3.28	10.31	11.10	0.55	2.56	2.89	2.4	11.4	12.8	98	4.03	A	A+	4.19	6.46	2159	1.23
	154504165	1.49	1.49	1.98	1.98	3.47	3.56	10.40	11.11	0.60	2.61	2.89	2.7	11.6	12.8	98	3.98	A	A+	4.28	6.46	2114	1.23
	154504184	1.39	1.39	1.86	1.86	3.90	3.76	10.40	11.11	0.64	2.61	2.89	2.8	11.6	12.8	98	3.98	A	A+	4.29	6.46	2110	1.23
	154504204	1.30	1.30	1.73	1.73	4.33	3.99	10.40	11.24	0.66	2.51	2.90	2.9	11.1	12.9	98	4.14	A	A+	4.28	6.46	2115	1.23
	154504224	1.20	1.20	1.60	1.60	4.80	4.27	10.40	11.47	0.67	2.38	2.81	3.0	10.6	12.5	98	4.37	A	A+	4.37	6.46	2072	1.22
	154504247	1.11	1.11	1.48	1.48	5.24	4.58	10.40	11.50	0.71	2.36	2.79	3.1	10.5	12.4	98	4.41	A	A+	4.41	6.46	2052	1.22
	154504265	1.56	1.56	2.08	2.60	2.60	3.42	10.40	11.10	0.58	2.62	2.89	2.6	11.6	12.8	98	3.97	A	A+	4.22	6.46	2144	1.23
	154504285	1.42	1.42	1.89	2.36	3.31	3.70	10.40	11.11	0.62	2.61	2.89	2.8	11.6	12.8	98	3.98	A	A+	4.29	6.46	2110	1.23
	154504304	1.33	1.33	1.78	2.22	3.73	3.90	10.40	11.11	0.66	2.61	2.89	2.9	11.6	12.8	98	3.98	A	A+	4.29	6.46	2110	1.23
	154504324	1.25	1.25	1.66	2.08	4.16	4.13	10.40	11.24	0.69	2.51	2.90	3.1	11.1	12.9	98	4.14	A	A+	4.28	6.46	2114	1.23
	154504344	1.16	1.16	1.54	1.93	4.62	4.41	10.40	11.47	0.69	2.38	2.81	3.1	10.6	12.5	98	4.37	A	A+	4.40	6.46	2057	1.22
	154504367	1.07	1.07	1.42	1.78	5.06	4.72	10.40	11.50	0.76	2.36	2.79	3.4	10.5	12.4	98	4.41	A	A+	4.41	6.46	2052	1.21
	154504385	1.30	1.30	1.73	3.03	3.03	3.99	10.40	11.11	0.69	2.61	2.89	3.1	11.6	12.8	98	3.98	A	A+	4.36	6.46	2076	1.22
	154504404	1.23	1.23	1.64	2.87	3.44	4.18	10.40	11.12	0.71	2.61	2.89	3.1	11.6	12.8	98	3.98	A	A+	4.36	6.46	2074	1.22
	154504424	1.16	1.16	1.54	2.70	3.85	4.41	10.40	11.25	0.74	2.51	2.89	3.3	11.1	12.8	98	4.14	A	A+	4.36	6.46	2076	1.22
	154504444	1.08	1.08	1.43	2.51	4.30	4.69	10.40	11.48	0.74	2.37	2.80	3.3	10.5	12.4	98	4.39	A	A+	4.47	6.46	2024	1.26
	154504467	1.00	1.00	1.33	2.33	4.73	5.00	10.40	11.51	0.81	2.36	2.79	3.6	10.5	12.4	98	4.41	A	A+	4.51	6.46	2006	1.26
	154504484	1.16	1.16	1.55	3.26	3.26	4.38	10.40	11.13	0.76	2.60	2.88	3.4	11.5	12.8	98	4.00	A	A+	4.40	6.46	2058	1.22
	154504504	1.10	1.10	1.46	3.08	3.66	4.61	10.40	11.26	0.79	2.50	2.89	3.5	11.1	12.8	98	4.16	A	A+	4.36	6.46	2076	1.22
	154504524	1.03	1.03	1.37	2.87	4.11	4.89	10.40	11.49	0.79	2.37	2.80	3.5	10.5	12.4	98	4.39	A	A+	4.47	6.46	2022	1.26
	154504544	1.04	1.04	1.39	3.47	3.47	4.83	10.40	11.38	0.82	2.46	2.84	3.6	10.9	12.6	98	4.23	A	A+	4.34	6.46	2083	1.22
	154504565	1.49	1.49	2.48	2.48	2.48	3.56	10.40	11.10	0.60	2.62	2.89	2.7	11.6	12.8	98	3.97	A	A+	4.23	6.46	2141	1.23
	154504585	1.36	1.36	2.26	2.26	3.17	3.84	10.40	11.11	0.67	2.61	2.89	3.0	11.6	12.8	98	3.98	A	A+	4.30	6.46	2103	1.23
	154504604	1.28	1.28	2.13	2.13	3.58	4.04	10.40	11.11	0.69	2.61	2.89	3.1	11.6	12.8	98	3.98	A	A+	4.31	6.46	2098	1.22
	154504624	1.20	1.20	2.00	2.00	4.00	4.27	10.40	11.24	0.71	2.51	2.90	3.1	11.1	12.9	98	4.14	A	A+	4.29	6.46	2110	1.23
	154504644	1.11	1.11	1.86	1.86	4.46	4.55	10.40	11.47	0.72	2.38	2.81	3.2	10.6	12.5	98	4.37	A	A+	4.40	6.46	2054	1.22
	154504667	1.03	1.03	1.72	1.72	4.89	4.86	10.40	11.50	0.79	2.36	2.79	3.5	10.5	12.4	98	4.41	A	A+	4.43	6.46	2043	1.21
	154504685	1.25	1.25	2.08	2.91	2.91	4.13	10.40	11.11	0.71	2.61	2.89	3.1	11.6	12.8	98	3.98	A	A+	4.39	6.46	2061	1.22
	154504704	1.18	1.18	1.97	2.76	3.31	4.32	10.40	11.12	0.76	2.61	2.89	3.4	11.6	12.8	98	3.98	A	A+	4.40	6.46	2058	1.22
	154504724	1.11	1.11	1.86	2.60	3.71	4.55	10.40	11.25	0.76	2.51	2.89	3.4	11.1	12.8	98	4.14	A	A+	4.36	6.46	2076	1.22
	154504744	1.04	1.04	1.73	2.43	4.16	4.83	10.40	11.48	0.79	2.37	2.80	3.5	10.5	12.4	98	4.39	A	A+	4.46	6.46	2029	1.26
	154504767	1.12	1.12	1.87	3.14	3.14	4.52	10.40	11.13	0.79	2.60	2.88	3.5	11.5	12.8	98	4.00	A	A+	4.40	6.46	2058	1.22
	154504784	1.06	1.06	1.77	2.97	3.54	4.75	10.40	11.26	0.82	2.50	2.89	3.6	11.1	12.8	98	4.16	A	A+	4.36	6.46	2074	1.22
	154504804	1.01	1.01	1.68	3.35	3.35	4.97	10.40	11.38	0.84	2.46	2.84	3.7	10.9	12.6	98	4.23	A	A+	4.36	6.46	2076	1.22
	154504824	1.16	1.16	2.70	2.70	2.70	4.41	10.40	11.12	0.76	2.61	2.89	3.4	11.6	12.8	98	3.98	A	A+	4.46	6.46	2028	1.26
	154504844	1.10	1.10	2.56	2.56	3.08	4.61	10.40	11.13	0.81	2.60	2.88	3.6	11.5	12.8	98	4.00	A	A+	4.47	6.46	2025	1.26
	154504864	1.04	1.04	2.43	2.43	3.47	4.83	10.40	11.26	0.84	2.50	2.89	3.7	11.1	12.8	98	4.16	A	A+	4.46	6.46	2028	1.26
	154504884	1.05	1.05	2.44	2.93	2.93	4.80	10.40	11.14	0.87	2.60	2.88	3.9	11.5	12.8	98	4.00	A	A+	4.45	6.46	2033	1.26
	154504904	1.63	2.17	2.17	2.17	3.28	10.31	11.10	11.10	0.55	2.56	2.89	2.4	11.4	12.8	98	4.03	A	A+	4.22	6.46	2144	1.23
	154504925	1.56	2.08	2.08	2.08	2.60	3.42	10.40	11.10	0.58	2.62	2.89	2.6	11.6	12.8	98	3.97	A	A+	4.23	6.46	2141	1.23
	154504945	1.42	1.89	1.89	1.89	3.31	3.70	10.40	11.11	0.62	2.61	2.89	2.8	11.6	12.8	98	3.98	A	A+	4.31	6.46	2100	1.23
	154504964	1.33	1.78	1.78	1.78	3.73	3.90	10.40	11.11	0.66	2.61	2.89	2.9	11.6	12.8	98	3.98	A	A+	4.31	6.46	2098	1.22
	154504984	1.25	1.66	1.66	1.66	4.16	4.13	10.40	11.24	0.69	2.51	2.90	3.1	11.1	12.9	98	4.14	A	A+	4.29	6.46	2110	1.23
	154505004	1.16	1.54	1.54	1.54	4.62	4.41	10.40	11.47	0.69	2.38	2.81	3.1	10.6	12.5	98	4.37	A	A+	4.40	6.46	2054	1.22
	154505024	1.07	1.42	1.42	1.42	5.06	4.72	10.40	11.50	0.76	2.36	2.79	3.4	10.5	12.4	98	4.41	A	A+	4.43	6.46	2043	1.21
	154505045	1.49	1.98	1.98	2.48	2.48	3.56	10.40	11.10	0.60	2.62	2.89	2.7	11.6	12.8	98	3.97	A	A+	4.23	6.46	2137	1.23
	154505065	1.36	1.81	1.81	2.26	3.17	3.84	10.40	11.11	0.67	2.61	2.89	3.0	11.6	12.8	98	3.98	A	A+	4.31	6.46	2098	1.22
	154505084	1.28	1.70	1.70	2.13	3.58	4.04	10.40	11.11	0.69	2.61	2.89	3.1	11.6	12.8	98	3.98	A	A+	4.31	6.46	2098	1.22
	154505104	1.20	1.60	1.60	2.00	4.00	4.27	10.40	11.24	0.71	2.51	2.90	3.1	11.1	12.9	98	4.14	A	A+	4.31	6.46	2100	1.23
154505124	1.11	1.49	1.49	1.86	4.46	4.55	10.40	11.47	0.72	2.38	2.81	3.2	10.6	12.5	98	4.37	A	A+	4.41	6.46	2052	1.22	
154505147	1.03	1.38	1.38	1.72	4.89	4.86	10.40	11.50	0.79	2.36	2.79	3.5	10.5	12.4	98	4.41	A	A+	4.44	6.46	2036	1.27	
154505165	1.25	1.66	1.66	2.91	2.91	4.13	10.40	11.11	0.71	2.61	2.89	3.1	11.6	12.8	98	3.98	A	A+	4.40	6.46	2058	1.22	
154505184	1.18	1.58	1.58	2.76	3.31	4.32	10.40	11.12	0.76	2.61	2.89	3.4	11.6	12.8	98	3.98	A	A+	4.40	6.46	2058	1.22	
154505204	1.11	1.49	1.49	2.60	3.71	4.55	10.40	11.25	0.76	2.51	2.89	3.4	11.1	12.8	98	4.14	A	A+	4.40	6.46	2058	1.22	
154505224	1.04	1.39	1.39	2.43	4.16	4.83	10.40	11.48	0.79	2.37	2.80	3.5	10.5	12.4	98	4.39	A	A+	4.49	6.46	2015	1.26	
154505244	1.12	1.50	1.50	3.14	3.14	4.52	10.40	11.13	0.79	2.60	2.88	3.5	11.5	12.8	98	4.00	A	A+	4.40	6.46	2056	1.22	
154505264	1.06	1.41	1.41	2.97	3.54	4.75																	

Combination tables

Heating

Outdoor unit	Indoor unit	Heating capacity (kW)					Total capacity (kW)			Power input (kW)			Total current (A)			Power factor (%)	COP	Energy label	Seasonal data				
		A room	B room	C room	D room	E room	Min.	Nom.	Max.	Min.	Nom.	Max.	Min.	Nom.	Max.				Label	SCOP	Pdesign	AEC	Back-up heater capacity at -10°C
5MXS90E	142441424	1.05	1.74	1.74	2.93	2.93	4.80	10.40	11.13	0.87	2.60	2.88	3.9	11.5	12.8	98	4.00	A	A+	4.41	6.46	2054	1.21
	142441425	1.08	1.79	2.51	2.51	2.51	4.69	10.40	11.12	0.84	2.61	2.89	3.7	11.6	12.8	98	3.98	A	A+	4.49	6.46	2017	1.26
	142441426	1.03	1.71	2.39	2.39	2.87	4.89	10.40	11.13	0.87	2.60	2.88	3.9	11.5	12.8	98	4.00	A	A+	4.50	6.46	2010	1.26
	142441427	1.01	2.35	2.35	2.35	2.35	4.97	10.40	11.13	0.90	2.60	2.88	4.0	11.5	12.8	98	4.00	A	A+	4.55	6.46	1986	1.25
	142441428	2.08	2.08	2.08	2.08	2.08	3.42	10.40	11.10	0.58	2.62	2.89	2.6	11.6	12.8	98	3.97	A	A+	4.23	6.46	2137	1.23
	142441429	1.98	1.98	1.98	1.98	2.48	3.56	10.40	11.10	0.60	2.62	2.89	2.7	11.6	12.8	98	3.97	A	A+	4.24	6.46	2135	1.23
	142441430	1.81	1.81	1.81	1.81	3.16	3.84	10.40	11.11	0.67	2.61	2.89	3.0	11.6	12.8	98	3.98	A	A+	4.34	6.46	2085	1.22
	142441431	1.70	1.70	1.70	1.70	3.60	4.04	10.40	11.11	0.69	2.61	2.89	3.1	11.6	12.8	98	3.98	A	A+	4.34	6.46	2084	1.22
	142441432	1.60	1.60	1.60	1.60	4.00	4.27	10.40	11.24	0.71	2.51	2.90	3.1	11.1	12.9	98	4.14	A	A+	4.31	6.46	2098	1.22
	142441433	1.49	1.49	1.49	1.49	4.44	4.55	10.40	11.47	0.72	2.38	2.81	3.2	10.6	12.5	98	4.37	A	A+	4.41	6.46	2052	1.22
	142441434	1.38	1.38	1.38	1.38	4.88	4.86	10.40	11.50	0.79	2.36	2.79	3.5	10.5	12.4	98	4.41	A	A+	4.47	6.46	2022	1.26
	142441435	1.90	1.90	1.90	2.35	2.35	3.70	10.40	11.10	0.62	2.62	2.89	2.8	11.6	12.8	98	3.97	A	A+	4.25	6.46	2128	1.23
	142441436	1.73	1.73	1.73	2.17	3.04	3.99	10.40	11.11	0.69	2.61	2.89	3.1	11.6	12.8	98	3.98	A	A+	4.34	6.46	2084	1.22
	142441437	1.64	1.64	1.64	2.05	3.43	4.18	10.40	11.11	0.71	2.61	2.89	3.1	11.6	12.8	98	3.98	A	A+	4.34	6.46	2084	1.22
	142441438	1.54	1.54	1.54	1.93	3.85	4.41	10.40	11.24	0.74	2.51	2.90	3.3	11.1	12.9	98	4.14	A	A+	4.34	6.46	2085	1.22
	142441439	1.43	1.43	1.43	1.80	4.31	4.69	10.40	11.47	0.74	2.38	2.81	3.3	10.6	12.5	98	4.37	A	A+	4.41	6.46	2050	1.21
	142441440	1.33	1.33	1.33	1.67	4.74	5.00	10.40	11.50	0.82	2.36	2.79	3.6	10.5	12.4	98	4.41	A	A+	4.48	6.46	2020	1.26
	142441441	1.90	1.90	1.90	2.35	2.35	3.70	10.40	11.10	0.62	2.62	2.89	2.8	11.6	12.8	98	3.97	A	A+	4.40	6.46	2056	1.22
	142441442	1.52	1.52	1.52	2.66	3.18	4.46	10.40	11.12	0.79	2.55	2.89	3.5	11.3	12.8	98	4.08	A	A+	4.40	6.46	2056	1.21
	142441443	1.43	1.43	1.43	2.51	3.60	4.69	10.40	11.25	0.82	2.51	2.89	3.6	11.1	12.8	98	4.14	A	A+	4.40	6.46	2056	1.22
	142441444	1.34	1.34	1.34	2.35	4.03	4.97	10.40	11.48	0.82	2.37	2.80	3.6	10.5	12.4	98	4.39	A	A+	4.51	6.46	2006	1.26
	142441445	1.44	1.44	1.44	3.04	3.04	4.66	10.40	11.13	0.81	2.55	2.88	3.6	11.3	12.8	98	4.08	A	A+	4.41	6.46	2054	1.21
	142441446	1.37	1.37	1.37	2.87	3.42	4.89	10.40	11.26	0.84	2.56	2.95	3.7	11.4	13.1	98	4.06	A	A+	4.40	6.46	2056	1.22
	142441447	1.81	1.81	2.26	2.26	2.26	3.84	10.40	11.10	0.67	2.62	2.89	3.0	11.6	12.8	98	3.97	A	A+	4.25	6.46	2126	1.23
	142441448	1.66	1.66	2.08	2.08	2.92	4.13	10.40	11.11	0.71	2.61	2.89	3.1	11.6	12.8	98	3.98	A	A+	4.34	6.46	2084	1.22
	142441449	1.58	1.58	1.97	1.97	3.30	4.32	10.40	11.11	0.74	2.56	2.89	3.3	11.4	12.8	98	4.06	A	A+	4.34	6.46	2083	1.22
	142441450	1.49	1.49	1.86	1.86	3.70	4.55	10.40	11.24	0.76	2.51	2.90	3.4	11.1	12.9	98	4.14	A	A+	4.34	6.46	2084	1.22
	142441451	1.39	1.39	1.73	1.73	4.16	4.83	10.40	11.47	0.80	2.38	2.81	3.5	10.6	12.5	98	4.37	A	A+	4.43	6.46	2043	1.21
	142441452	1.54	1.54	1.92	2.70	2.70	4.41	10.40	11.11	0.76	2.61	2.89	3.4	11.6	12.8	98	3.98	A	A+	4.41	6.46	2054	1.21
	142441453	1.46	1.46	1.84	2.56	3.08	4.61	10.40	11.12	0.82	2.55	2.89	3.6	11.3	12.8	98	4.08	A	A+	4.42	6.46	2047	1.21
	142441454	1.39	1.39	1.72	2.43	3.47	4.83	10.40	11.25	0.84	2.51	2.89	3.7	11.1	12.8	98	4.14	A	A+	4.40	6.46	2056	1.22
	142441455	1.40	1.40	1.74	2.93	2.93	4.80	10.40	11.13	0.87	2.60	2.94	3.9	11.5	13.0	98	4.00	A	A+	4.44	6.46	2040	1.27
	142441456	1.44	1.44	2.52	2.50	2.50	4.69	10.40	11.12	0.84	2.61	2.89	3.7	11.6	12.8	98	3.98	A	A+	4.50	6.46	2010	1.26
	142441457	1.37	1.37	2.40	2.39	2.87	4.89	10.40	11.13	0.87	2.60	2.94	3.9	11.5	13.0	98	4.00	A	A+	4.51	6.46	2008	1.26
	142441458	1.72	2.17	2.17	2.17	2.17	3.99	10.40	11.10	0.69	2.62	2.89	3.1	11.6	12.8	98	3.97	A	A+	4.28	6.46	2113	1.23
	142441459	1.60	2.00	2.00	2.00	2.80	4.27	10.40	11.11	0.74	2.61	2.89	3.3	11.6	12.8	98	3.98	A	A+	4.35	6.46	2081	1.22
	142441460	1.52	1.90	1.90	1.90	3.18	4.46	10.40	11.11	0.79	2.56	2.89	3.5	11.4	12.8	98	4.06	A	A+	4.35	6.46	2079	1.22
	142441461	1.44	1.79	1.79	1.79	3.59	4.69	10.40	11.24	0.82	2.51	2.90	3.6	11.1	12.9	98	4.14	A	A+	4.34	6.46	2083	1.22
	142441462	1.33	1.68	1.68	1.68	4.03	4.97	10.40	11.47	0.82	2.38	2.81	3.6	10.6	12.5	98	4.37	A	A+	4.44	6.46	2036	1.27
	142441463	1.48	1.86	1.86	2.60	2.60	4.55	10.40	11.11	0.82	2.61	2.89	3.6	11.6	12.8	98	3.98	A	A+	4.42	6.46	2047	1.21
	142441464	1.41	1.77	1.77	2.48	2.97	4.75	10.40	11.12	0.84	2.55	2.89	3.7	11.3	12.8	98	4.08	A	A+	4.44	6.46	2040	1.27
	142441465	1.34	1.68	1.68	2.35	3.35	4.97	10.40	11.25	0.87	2.51	2.89	3.9	11.1	12.8	98	4.14	A	A+	4.41	6.46	2054	1.21
142441466	1.34	1.69	1.69	2.84	2.84	4.94	10.40	11.13	0.90	2.60	2.94	4.0	11.5	13.0	98	4.00	A	A+	4.44	6.46	2039	1.27	
142441467	1.38	1.73	2.43	2.43	2.43	4.83	10.40	11.12	0.87	2.61	2.89	3.9	11.6	12.8	98	3.98	A	A+	4.51	6.46	2008	1.26	
142441468	2.08	2.08	2.08	2.08	2.08	4.13	10.40	11.10	0.72	2.62	2.89	3.2	11.6	12.8	98	3.97	A	A+	4.29	6.46	2110	1.23	
142441469	1.93	1.93	1.93	1.93	2.68	4.41	10.40	11.11	0.77	2.61	2.89	3.4	11.6	12.8	98	3.98	A	A+	4.35	6.46	2079	1.22	
142441470	1.83	1.83	1.83	1.83	3.08	4.61	10.40	11.11	0.82	2.56	2.89	3.6	11.4	12.8	98	4.06	A	A+	4.37	6.46	2071	1.22	
142441471	1.73	1.73	1.73	1.73	3.48	4.83	10.40	11.24	0.85	2.51	2.90	3.8	11.1	12.9	98	4.14	A	A+	4.35	6.46	2081	1.22	
142441472	1.80	1.80	1.80	2.50	2.50	4.69	10.40	11.11	0.85	2.61	2.89	3.8	11.6	12.8	98	3.98	A	A+	4.44	6.46	2040	1.27	
142441473	1.71	1.71	1.71	2.40	2.87	4.89	10.40	11.12	0.87	2.61	2.89	3.9	11.6	12.8	98	3.98	A	A+	4.47	6.46	2026	1.27	
142441474	1.69	1.69	2.34	2.34	2.34	4.97	10.40	11.12	0.90	2.61	2.89	4.0	11.6	12.8	98	3.98	A	A+	4.51	6.46	2008	1.26	

- Notes:
1. Cooling capacity is based on 27°CDB/19°CWB (Indoor temperature), 35°CDB (Outdoor temperature). Heating capacity is based on 20°CDB (Indoor temperature), 7°CDB/6°CWB (Outdoor temperature).
 2. The total ability of connected indoor unit is up to 14.5kW.
 3. It is impossible to connect the indoor unit for one room only.
 4. The above is the value for connecting with the following indoor units.
1.5kW: wall mounted CTXS-K series; 2.0, 2.5, 3.5, 4.2, 5.0kW: wall mounted FTXS-K series
6.0, 7.1 kW class; wall mounted G series

Combination tables

Cooling

Outdoor unit	Indoor unit	Cooling capacity (kW)		Total capacity (kW)			Power input (kW)			Total current (A)			Power factor (%)	EER	Energy label	AEC (kWh)	Seasonal data			
		A room	B room	Min.	Nom.	Max.	Min.	Nom.	Max.	Min.	Nom.	Max.					Label	SEER	Pdesign	AEC
2AMX40G	2.0	2.00	/	1.50	2.00	2.40	0.330	0.440	0.570	1.5	2.0	2.6	94	4.55	A	220	/	/	/	/
	2.5	2.50	/	1.50	2.50	3.00	0.330	0.610	0.800	1.5	2.8	3.7	94	4.10	A	305	/	/	/	/
	3.5	3.50	/	1.50	3.50	4.00	0.330	1.050	1.360	1.5	4.8	6.2	95	3.33	A	525	/	/	/	/
	2.0+2.0	2.00	2.00	1.75	4.00	4.20	0.310	1.040	1.120	1.4	4.8	5.2	94	3.85	A	520	A++	6.38	4.00	220
	2.0+2.5	1.85	2.15	1.75	4.00	4.30	0.310	1.030	1.170	1.4	4.8	5.4	94	3.88	A	515	A++	6.26	4.00	224
	2.0+3.5	1.75	2.25	1.75	4.00	4.50	0.310	1.000	1.230	1.4	4.6	5.7	94	4.00	A	500	A++	6.50	4.00	216
	2.5+2.5	2.00	2.00	1.75	4.00	4.40	0.310	1.020	1.230	1.4	4.7	5.7	94	3.92	A	510	A++	6.26	4.00	224
	2.5+3.5	1.80	2.20	1.75	4.00	4.60	0.310	0.990	1.310	1.4	4.6	6.1	94	4.04	A	495	A++	6.49	4.00	216

Heating

Outdoor unit	Indoor unit	Heating capacity (kW)		Total capacity (kW)			Power input (kW)			Total current (A)			Power factor (%)	COP	Energy label	AEC (kWh)	Seasonal data				
		A room	B room	Min.	Nom.	Max.	Min.	Nom.	Max.	Min.	Nom.	Max.					Label	SCOP	Pdesign	AEC	Back-up heater capacity at -10°C
2AMX40G	2.0	3.00	/	1.10	3.00	3.70	0.260	0.820	1.230	1.2	3.8	5.7	94	3.66	A	410	/	/	/	/	/
	2.5	3.40	/	1.10	3.40	4.10	0.260	1.020	1.480	1.2	4.7	6.8	95	3.33	C	510	/	/	/	/	/
	3.5	3.80	/	1.10	3.80	4.40	0.260	1.280	1.720	1.2	5.9	7.9	95	2.97	D	640	/	/	/	/	/
	2.0+2.0	2.10	2.10	1.40	4.20	4.60	0.250	0.960	1.120	1.1	4.4	5.1	95	4.38	A	480	A+	4.15	2.99	1009	0.56
	2.0+2.5	2.10	2.30	1.40	4.40	4.70	0.250	1.040	1.170	1.1	4.7	5.3	96	4.23	A	520	A+	4.16	2.99	1006	0.58
	2.0+3.5	2.00	2.40	1.40	4.40	4.70	0.240	1.000	1.120	1.1	4.5	5.1	96	4.40	A	500	A+	4.14	2.96	1001	0.56
	2.5+2.5	2.20	2.20	1.40	4.40	4.70	0.250	1.030	1.160	1.1	4.7	5.3	96	4.27	A	515	A+	1.16	3.00	1009	0.59
	2.5+3.5	2.05	2.35	1.40	4.40	4.70	0.240	0.990	1.110	1.1	4.5	5.0	96	4.44	A	495	A+	4.15	2.96	999	0.58

- Notes:
- The total capacity of each connected indoor unit is up to 8.5 kW.
 - The values above are for connecting with the following indoor unit types:
2.0, 2.5, 3.5, 5.0 kW class
Wall-mounted ATXS-K series
 - These indoor units can only be used in a multi-unit setup.
 - Cooling capacity conditions:
Indoor temperature 27°C DB / 19°C WB
Outdoor temperature 35°C DB
 - Heating capacity conditions:
Indoor temperature 20°C DB
Outdoor temperature 7°C DB / 6°C WB
 - Design temperature: -10°C

Combination tables

Cooling

Outdoor unit	Indoor unit	Cooling capacity (kW)		Total capacity (kW)			Power input (kW)			Total current (A)			Power factor (%)	EER	Energy label	AEC (kWh)	Seasonal data			
		A room	B room	Min.	Nom.	Max.	Min.	Nom.	Max.	Min.	Nom.	Max.					Label	SEER	Pdesign	AEC
2AMX50G	2.0	2.00	/	1.60	2.00	2.60	0.330	0.390	0.580	1.6	1.9	2.8	91	5.13	A	195	/	/	/	/
	2.5	2.50	/	1.60	2.50	3.10	0.330	0.560	0.800	1.6	2.7	3.8	91	4.46	A	280	/	/	/	/
	3.5	3.50	/	1.60	3.50	4.00	0.320	0.940	1.240	1.5	4.5	5.9	91	3.72	A	470	/	/	/	/
	5.0	5.00	/	1.60	5.00	5.10	0.320	1.940	2.070	1.5	9.3	9.9	91	2.58	E	970	/	/	/	/
	2.0+2.0	2.00	2.00	1.95	4.00	5.00	0.340	0.870	1.360	1.6	4.2	6.5	91	4.60	A	435	A++	6.55	4.00	214
	2.0+2.5	2.00	2.50	1.95	4.50	5.10	0.340	1.070	1.450	1.6	5.1	6.9	91	4.21	A	535	A++	6.53	4.50	242
	2.0+3.5	1.82	3.18	1.95	5.00	5.40	0.340	1.350	1.620	1.6	6.5	7.7	91	3.70	A	675	A++	6.51	5.00	269
	2.0+5.0	1.43	3.57	1.95	5.00	5.50	0.340	1.310	1.710	1.6	6.3	8.2	91	3.82	A	655	A++	6.50	5.00	270
	2.5+2.5	2.50	2.50	1.95	5.00	5.30	0.340	1.380	1.610	1.6	6.6	7.7	91	3.62	A	690	A++	6.39	5.00	274
	2.5+3.5	2.08	2.92	1.95	5.00	5.40	0.340	1.340	1.610	1.6	6.4	7.7	91	3.73	A	670	A++	6.48	5.00	270
	2.5+5.0	1.67	3.33	1.95	5.00	5.50	0.340	1.300	1.700	1.6	6.2	8.1	91	3.85	A	650	A++	6.48	5.00	271
	3.5+3.5	2.50	2.50	1.98	5.00	5.40	0.340	1.290	1.550	1.6	6.2	7.4	91	3.88	A	645	A++	6.55	5.00	268
	3.5+5.0	2.06	2.94	1.98	5.00	5.50	0.340	1.270	1.620	1.6	6.1	7.7	91	3.94	A	635	A++	6.54	5.00	268

Heating

Outdoor unit	Indoor unit	Heating capacity (kW)		Total capacity (kW)			Power input (kW)			Total current (A)			Power factor (%)	COP	Energy label	AEC (kWh)	Seasonal data				
		A room	B room	Min.	Nom.	Max.	Min.	Nom.	Max.	Min.	Nom.	Max.					Label	SCOP	Pdesign	AEC	Back-up heater capacity at -10°C
2AMX50G	2.0	3.00	/	1.16	3.00	3.70	0.230	0.780	1.080	1.1	3.7	5.2	91	3.85	A	390	/	/	/	/	/
	2.5	3.40	/	1.16	3.40	4.10	0.220	0.940	1.270	1.1	4.5	6.1	91	3.62	A	470	/	/	/	/	/
	3.5	4.00	/	1.16	4.00	4.60	0.220	1.180	1.460	1.1	5.6	7.0	91	3.39	C	590	/	/	/	/	/
	5.0	5.40	/	1.28	5.40	5.60	0.230	1.770	1.910	1.1	8.5	9.1	91	3.05	D	885	/	/	/	/	/
	2.0+2.0	2.65	2.65	1.18	5.30	5.70	0.220	1.260	1.400	1.1	6.0	6.7	91	4.21	A	630	A+	4.12	3.97	1351	0.76
	2.0+2.5	2.44	3.06	1.18	5.50	5.80	0.220	1.320	1.430	1.1	6.3	6.8	91	4.17	A	660	A+	4.12	3.97	1351	0.76
	2.0+3.5	2.04	3.56	1.24	5.60	5.90	0.230	1.310	1.390	1.1	6.3	6.6	91	4.27	A	655	A+	4.14	4.28	1448	0.82
	2.0+5.0	1.63	4.07	1.29	5.70	6.20	0.230	1.330	1.480	1.1	6.4	7.1	91	4.29	A	665	A+	4.11	4.42	1505	0.86
	2.5+2.5	2.80	2.80	1.18	5.60	5.80	0.220	1.380	1.430	1.1	6.6	6.8	91	4.06	A	690	A+	4.10	4.25	1452	0.81
	2.5+3.5	2.38	3.32	1.24	5.70	6.00	0.230	1.340	1.450	1.1	6.4	6.9	91	4.25	A	670	A+	4.09	4.41	1510	0.84
	2.5+5.0	1.90	3.80	1.35	5.70	6.30	0.230	1.320	1.520	1.1	6.3	7.3	91	4.32	A	660	A+	4.10	4.42	1510	0.84
	3.5+3.5	2.85	2.85	1.30	5.70	6.10	0.230	1.330	1.460	1.1	6.4	7.0	91	4.29	A	665	A+	4.17	4.43	1489	0.86
	3.5+5.0	2.35	3.35	1.35	5.70	6.40	0.230	1.310	1.560	1.1	6.3	7.5	91	4.35	A	655	A+	4.17	4.45	1494	0.84

- Notes:
1. The total capacity of each connected indoor unit is up to 6.0 kW.
 2. The values above are for connecting with the following indoor unit types:
2.0, 2.5, 3.5 kW class
Wall-mounted ATXS-K series
 3. These indoor units can only be used in a multi-unit setup.
 4. Cooling capacity conditions:
Indoor temperature 27°C DB / 19°C WB
Outdoor temperature 35°C DB
Heating capacity conditions:
Indoor temperature 20°C DB
Outdoor temperature 7°C DB / 6°C WB
 5. Design temperature: -10°C

Combination tables

Cooling

Outdoor unit	Indoor unit	Cooling capacity (kW)			Total capacity (kW)			Power input (kW)			Total current (A)			Power factor (%)	EER	Energy label	AEC (kWh)	Seasonal data			
		A room	B room		Min.	Nom.	Max.	Min.	Nom.	Max.	Min.	Nom.	Max.					Label	SEER	Pdesign	AEC
3AMX52E	2.0	2.00	/	/	1.76	2.00	2.84	0.350	0.460	0.740	1.6	2.1	3.4	96	4.35	A	230	/	/	/	/
	2.5	2.50	/	/	1.76	2.50	3.12	0.350	0.620	0.750	1.6	2.8	3.4	97	4.03	A	310	/	/	/	/
	3.5	3.50	/	/	1.76	3.50	4.18	0.350	0.970	1.290	1.6	4.3	5.7	98	3.61	A	485	/	/	/	/
	5.0	/	/	5.00	1.79	5.00	5.40	0.350	1.750	2.030	1.5	7.7	8.9	99	2.86	C	875	/	/	/	/
	2.0+2.0	2.00	2.00	/	1.88	4.00	5.96	0.350	0.950	1.910	1.5	4.2	8.4	99	4.21	A	475	A++	6.76	4.00	208
	2.0+2.5	2.00	2.50	/	1.88	4.50	6.23	0.350	1.180	2.140	1.5	5.2	9.4	99	3.81	A	590	A++	6.78	4.50	233
	2.0+3.5	1.89	3.31	/	1.88	5.20	6.24	0.350	1.550	2.070	1.5	6.8	9.1	99	3.35	A	775	A++	6.86	5.20	266
	2.0+5.0	1.49	/	3.71	1.88	5.20	6.47	0.350	1.420	2.150	1.5	6.2	9.4	99	3.66	A	710	A++	6.85	5.20	266
	2.5+2.5	2.50	2.50	/	1.88	5.00	6.23	0.350	1.450	2.140	1.5	6.4	9.4	99	3.45	A	725	A++	6.71	5.00	261
	2.5+3.5	2.17	3.03	/	1.88	5.20	6.35	0.350	1.550	2.250	1.5	6.8	9.9	99	3.35	A	775	A++	6.85	5.20	266
	2.5+5.0	1.73	/	3.47	1.88	5.20	6.47	0.350	1.420	2.070	1.5	6.2	9.1	99	3.66	A	710	A++	6.85	5.20	266
	3.5+3.5	2.60	2.60	/	1.88	5.20	6.40	0.350	1.550	2.250	1.5	6.8	9.9	99	3.35	A	775	A++	6.89	5.20	265
	3.5+5.0	2.14	/	3.06	1.88	5.20	6.49	0.350	1.420	2.090	1.5	6.2	9.2	99	3.66	A	710	A++	6.87	5.20	265
	20+20+20	1.73	1.73	1.73	1.86	5.19	7.04	0.350	1.240	2.160	1.5	5.4	9.5	99	4.19	A	620	A++	7.06	5.19	258
	20+20+25	1.60	1.60	1.99	1.86	5.19	7.04	0.350	1.240	2.160	1.5	5.4	9.5	99	4.19	A	620	A++	7.06	5.19	258
	20+20+35	1.38	1.38	2.43	1.95	5.19	7.06	0.370	1.240	2.160	1.6	5.4	9.5	99	4.19	A	620	A++	7.07	5.19	257
	20+25+25	1.49	1.85	1.85	1.86	5.19	7.04	0.350	1.240	2.160	1.5	5.4	9.5	99	4.19	A	620	A++	7.04	5.19	259
	20+25+35	1.30	1.63	2.27	1.95	5.20	7.06	0.370	1.240	2.160	1.6	5.4	9.5	99	4.19	A	620	A++	7.07	5.20	258
	20+35+35	1.16	2.02	2.02	1.95	5.20	7.07	0.370	1.240	2.160	1.6	5.4	9.5	99	4.19	A	620	A++	7.08	5.20	258
	25+25+25	1.73	1.73	1.73	1.95	5.19	7.04	0.370	1.240	2.160	1.6	5.4	9.5	99	4.19	A	620	A++	7.04	5.19	259
	25+25+35	1.53	1.53	2.14	1.95	5.20	7.06	0.370	1.230	2.160	1.6	5.4	9.5	99	4.23	A	615	A++	7.07	5.20	258
	20+20+50	1.16	1.16	2.88	2.11	5.20	7.30	0.380	1.220	2.260	1.7	5.4	9.9	99	4.26	A	610	A++	7.07	5.20	258

Heating

Outdoor unit	Indoor unit	Heating capacity (kW)			Total capacity (kW)			Power input (kW)			Total current (A)			Power factor (%)	COP	Energy label	AEC (kWh)	Seasonal data				
		A room	B room		Min.	Nom.	Max.	Min.	Nom.	Max.	Min.	Nom.	Max.					Label	SCOP	Pdesign	AEC	Back-up heater capacity at -10°C
3AMX52E	2.0	2.72	/	/	1.21	2.72	3.75	0.300	0.720	1.200	1.4	3.3	5.4	96	3.78	A	360	/	/	/	/	/
	2.5	3.40	/	/	1.21	3.40	4.00	0.300	0.990	1.260	1.3	4.4	5.6	97	3.43	B	495	/	/	/	/	/
	3.5	4.20	/	/	1.21	4.20	4.82	0.300	1.390	1.680	1.3	6.2	7.5	98	3.02	D	695	/	/	/	/	/
	5.0	/	/	5.80	1.33	5.80	6.79	0.300	2.160	2.590	1.3	9.5	11.4	99	2.69	E	1080	/	/	/	/	/
	2.0+2.0	3.05	3.05	/	1.28	6.10	7.00	0.310	1.700	2.280	1.4	7.5	10.0	99	3.59	B	850	A+	4.18	4.84	1620	0.93
	2.0+2.5	2.78	3.47	/	1.28	6.25	7.00	0.310	1.750	2.280	1.4	7.7	10.0	99	3.57	B	875	A+	4.18	4.84	1622	0.93
	2.0+3.5	2.38	4.17	/	1.34	6.55	7.04	0.310	1.860	2.280	1.4	8.2	10.0	99	3.52	B	930	A+	4.24	4.87	1608	0.94
	2.0+5.0	1.94	/	4.86	1.39	6.80	7.20	0.310	1.870	2.320	1.4	8.2	10.2	99	3.64	A	935	A+	4.26	4.88	1606	0.94
	2.5+2.5	3.25	3.25	/	1.28	6.50	7.00	0.310	1.860	2.310	1.4	8.2	10.1	99	3.49	B	930	A+	4.18	4.84	1622	0.93
	2.5+3.5	2.79	3.97	/	1.34	6.70	7.19	0.310	1.930	2.360	1.4	8.5	10.4	99	3.47	B	965	A+	4.24	4.87	1608	0.94
	2.5+5.0	2.27	/	4.53	1.45	6.80	7.35	0.310	1.870	2.320	1.4	8.2	10.2	99	3.64	A	935	A+	4.25	4.87	1605	0.93
	3.5+3.5	3.40	3.40	/	1.40	6.80	7.22	0.310	1.970	2.350	1.4	8.7	10.3	99	3.45	B	985	A+	4.27	4.89	1605	0.94
	3.5+5.0	2.80	/	4.00	1.45	6.80	7.50	0.310	1.830	2.310	1.4	8.0	10.1	99	3.72	A	915	A+	4.28	4.90	1603	0.94
	20+20+20	2.26	2.26	2.26	1.34	6.78	8.02	0.320	1.570	2.140	1.4	6.9	9.4	99	4.32	A	785	A+	4.46	4.93	1547	0.94
	20+20+25	2.09	2.09	2.60	1.34	6.78	8.02	0.320	1.570	2.140	1.4	6.9	9.4	99	4.32	A	785	A+	4.46	4.93	1547	0.94
	20+20+35	1.80	1.80	3.18	1.45	6.78	8.05	0.320	1.560	2.140	1.4	6.9	9.4	99	4.35	A	780	A+	4.49	4.92	1535	0.94
	20+25+25	1.94	2.42	2.42	1.34	6.78	8.02	0.320	1.570	2.140	1.4	6.9	9.4	99	4.32	A	785	A+	4.46	4.93	1549	0.94
	20+25+35	1.70	2.13	2.97	1.57	6.80	8.05	0.320	1.560	2.140	1.4	6.9	9.4	99	4.36	A	780	A+	4.47	4.92	1541	0.94
	20+35+35	1.52	2.64	2.64	1.56	6.80	8.08	0.320	1.560	2.140	1.4	6.9	9.4	99	4.36	A	780	A+	4.51	4.91	1524	0.94
	25+25+25	2.26	2.26	2.26	1.45	6.78	8.02	0.320	1.570	2.140	1.4	6.9	9.4	99	4.32	A	785	A+	4.45	4.94	1556	0.95
	25+25+35	2.00	2.00	2.80	1.57	6.80	8.05	0.320	1.560	2.140	1.4	6.9	9.4	99	4.36	A	780	A+	4.47	4.92	1543	0.94
	20+20+50	1.51	1.51	3.78	1.67	6.80	8.27	0.320	1.640	2.110	1.4	7.2	9.3	99	4.15	A	820	A+	4.48	4.92	1536	0.94

- Notes:
- The total capacity of each connected indoor unit is up to 9.0kW.
 - The values above are for connecting with the following indoor unit types:
2.0, 2.5, 3.5, 5.0 kW class
Wall-mounted ATXS-K series
 - These indoor units can only be used in a multi-unit setup.
 - Cooling capacity conditions:
Indoor temperature 27°C DB / 19°C WB
Outdoor temperature 35°C DB
Heating capacity conditions:
Indoor temperature 20°C DB
Outdoor temperature 7°C DB / 6°C WB
 - Design temperature: -10°C



Sky Air the solution for the light commercial sector

Sky Air is Daikin's industry-leading light commercial range, which has been designed for optimum seasonal energy efficiency. Providing the ideal solution for all kinds of small commercial spaces, the Sky Air series offers a complete comfort solution that puts you in total control of your heating and cooling, ventilation and air curtains.

Sky Air

Light commercial applications

Why choose a Daikin Sky Air	162		
Products overview indoor units	166		
Benefits overview indoor units	170		
Ceiling mounted cassette units	174	Wall mounted unit	196
FCQG-F / RZQSG-L3/9V1/L(8)Y1	174	FAQ-C / RZQSG-L3/9V1/L(8)Y1	196
FCQG-F / RZQG-L9V1/L(8)Y1	175	FAQ-C / RZQG-L9V1/L(8)Y1	197
FCQG-F / RXS-L3/L	176	Floor standing Units	198
FCQHG-F / RZQSG-L3/9V1/L(8)Y1	178	FVQ-C / RZQSG-L3/9V1/L(8)Y1	198
FCQHG-F + RZQG-L9V1/L(8)Y1	179	FVQ-C / RZQG-L9V1/L(8)Y1	199
FFQ-C / RXS-L3/L	181	FNQ-A / RXS-L3/L	200
ACQ-D / AZQS-B(8)V1/BY1	182	Products overview outdoor units	202
Concealed ceiling units	183	Benefits overview outdoor units	202
FDBQ-B	183	Why choose Seasonal Smart	204
FDXS-F(9) / RXS-L3/L	184	Pair, Twin, Triple, double twin applications	208
FBQ-D / RXS-L3/L	185	RZQSG-L3/9V1/L(8)Y1	208
FBQ-D / RZQSG-L3/9V1/L(8)Y1	186	RZQG-L9V1/L(8)Y1	209
FBQ-D / RZQG-L9V1/L(8)Y1	187	RZQ-C	210
FDQ-C / RZQSG-L3/9V1/L(8)Y1, RZQG-L9V1/L(8)Y1	188	Pair applications	211
FDQ-B / RZQ-C	189	AZQS-B(8)V1/BY1	211
ABQ-C / AZQS-B(8)V1/BY1	190	Rooftop	212
Ceiling suspended units	191	UATYQ-CY1	212
FHQ-C / RXS-L3/L	191	UATYP-AY1(B)	213
FHQ-C / RZQSG-L3/9V1/L(8)Y1	192	Options & accessories	214
FHQ-C / RZQG-L9V1/L(8)Y1	193		
AHQ-C / AZQS-B(8)V1/BY1	194		
FUQ-C / RZQG-L9V1/L(8)Y1	195		



Sky Air, the solution for the light commercial sector

Offering Comfort, Energy efficiency and Reliable systems

Why choose Sky Air

- Industry-leading product range for small offices, shops, retail stores, restaurants, banks or data centers
- From reliable and high quality comfort air conditioning, to customised applications with a smart use of energy and flexible installation and operation
- Extensive range which meets even the most stringent building specifications
- Ensures total control over your customers' space heating and cooling, ventilation and doorway climate separation requirements.

Benefits for the installer

- › Modular designs and factory fitted extras make installation easier to achieve.

Benefits for the consultant

- › You will have the confidence of knowing that you can recommend the right climate control systems to meet tomorrow's legislation
- › You will have systems that are designed to blend into any décor and provide optimal performance with top seasonal efficiencies
- › You will have access to innovative technology to maximize the climate control performance of the entire building
- › Your credentials as an eco-conscious consultant and designer will be enhanced.

Benefits for the end user

- › Your climate control system will meet legal requirements well beyond the current legislation
- › You will obtain optimal seasonal performance thus saving energy and reducing costs
- › The climate control system will add value to the building thus protecting your investment
- › You will save on installation and running costs, obtain rapid return on investment and contribute to ecological protection objectives.



Air curtain



Control systems



Cooling and heating



Flexible Installation



Ventilation



Heating and cooling

- › Extract heat from the outside air, even in cold weather (down to -20°C)
- › Electrically powered compressor
- › Extremely effective at heating
- › Silent and discreet
- › State-of-the-art technology to keep energy bills as low as possible



Top seasonal efficiency

- › A++ label both in cooling and heating for combination FCQHG71F/100F + RZQG71L9V1/100L9V1 **A++**



Wide range of heat pump units

- › Ideal for both new build and renovation projects
- › Select from a wide range of indoor units: wall mounted and floor standing, concealed or ceiling mounted
- › Very quiet and draught-free operation
- › For long or irregularly shaped rooms, you can use up to four indoor units linked to a single outdoor unit. All the indoor units are controlled at the same time



Replacement

All common split and Sky Air outdoor and indoor units can be used to replace R-22 and R-407C systems. Re-use existing piping and wiring



Flexible Installation

- › Outdoor units are neat and sturdy
- › They can be installed against a wall or on a roof or terrace



Control systems

User-friendly controls allow your customers to manage their Sky Air system for maximum efficiency:

- › From individualised unit control to centralised management via touchscreen options and code based controllers, they are in control at all times
- › The DIII-net connection is standard, allowing you to link into the wider building management systems
- › Buildings can be monitored from a distance using Internet monitoring



Ventilation

Daikin's ventilation option provides a supply of fresh air to help create a healthy and high quality indoor environment











Biddle air curtains

- › Biddle air curtains can be used in combination with the Sky Air system to provide highly efficient heating at building entrances: Ideal for buildings with open door policies such as retail stores
- › Year round climate control and comfort even on the most demanding days
- › Payback time of less than 12 months compared with electric air curtains



- | | | |
|---|--|---|
| 
Seasonal Smart
› For all types of commercial applications, even for infrastructure cooling
› Best efficiency!
› Most flexible installation
› Widest range of connectable indoor units | 
Seasonal Classic
› For all types of commercial applications
› Good value for money:
very efficient and comfortable indoor units | 
Siesta Sky Air
› Standard cooling/heating solution for small shops |
|---|--|---|

Seasonal efficiency		Up to A++ in cooling	Up to A++ in cooling	Up to A
Max. piping		Up to 75m	Up to 50m	Up to 50m
Operation range	Cooling	-15°C ~ 50°C	-15°C ~ 46°C	-5°C ~ 46°C
	Heating	-20°C ~ 15.5°C	-	-15°C ~ 15.5°C
Infrastructure cooling		✓	-	-
1. Variable Refrigerant Temperature		✓	✓	✓
2. Customizable		✓		

Connectable indoor units	 4-Way blow ceiling suspended cassette	 Floor standing unit	 4-Way blow ceiling suspended cassette
	 Round flow cassette	 Ceiling suspended unit	 Concealed floor standing unit
	 Fully flat cassette	 Wall mounted unit	 Concealed ceiling unit

Pair application	✓	✓	✓
Twin/triple/double twin	✓	✓	



1. Operates with variable refrigerant temperature: all Daikin Sky Air outdoor units are able to adapt their operation to meet your unique cooling and heating requirements, without compromising efficiency.

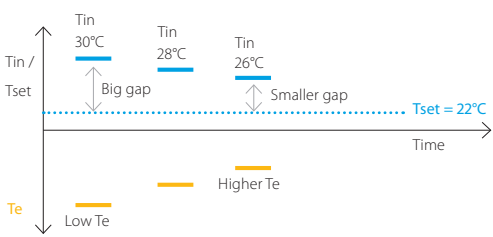

2. Go one step further in improving comfort and efficiency by having the possibility to customize the settings at time of installation. These special settings allow the boundaries of fluctuation of refrigerant's evaporating and condensing temperature to be customized to fit the application.

Cooling

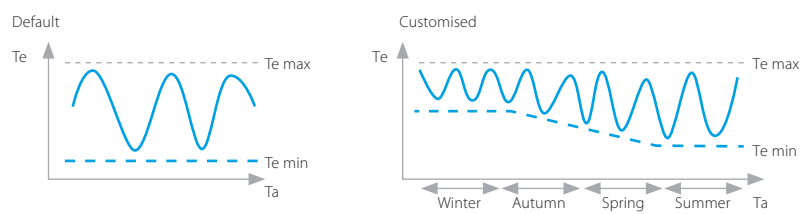

Heating

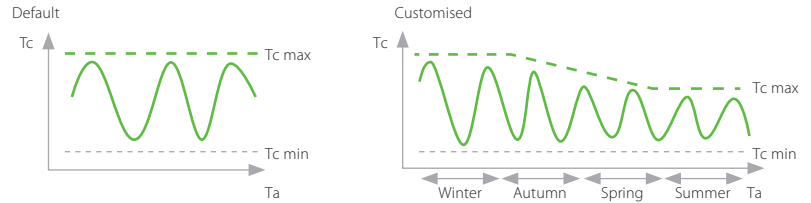

Tin = indoor temperature / Tset = setpoint / Te = evaporating temperature of refrigerant
 Tc = condensing temperature of refrigerant / Ta = ambient temperature

Sales supporting apps

Compare our industry-leading product range with competition in a smart and easy way.

seasoncalc.daikin.eu

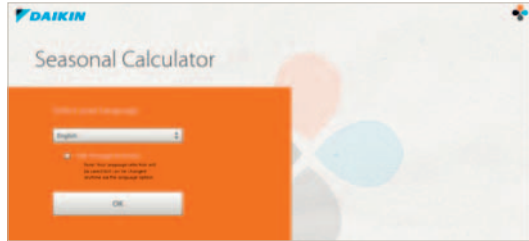

Literature

See all the literature available on www.daikineurope.com/support-and-manuals/catalogues

NEW Business portal

- › Experience our new extranet that thinks with you at my.daikin.eu
- › Find information in seconds via a powerful search
- › Customise the options so you see only info relevant for you
- › Access via mobile device or desktop

Internet

- › Find our solutions for different applications (www.daikineurope.com/commercial/applications)
- › See some of our references (www.daikineurope.com/references)
- › Get more commercial details on our flagship products

A few of our commercial literature for the professional network

Product catalogues:



Sky Air Catalogue
Detailed technical information & benefits on Sky Air/Ventilation/Biddle Air Curtain/Control systems/AHU

15-114



Ventilation Catalogue
Detailed info on Ventilation products

15-203

Product portfolios:



Sky Air product portfolio
Overview of Sky air product range

15-121



Controls systems portfolio
Overview of all Daikin control systems

15-301

Focus topic:



Replacement Technology
Clear installer benefits of VRV replacement technology

15-214



Infrastructure cooling
Clear installer benefits of infrastructure cooling with Seasonal Smart outdoor unit.

15-140

A few of our commercial literature for your customers

Reference book:



Reference catalogue
Daikin commercial and industrial references

15-213

Reference book: Solution Guides



Green Building Solutions
Clear building owner/investor benefits why to choose Daikin for a green building, with emphasis on BREEAM

15-216



Commercial Solutions
Daikin offers solutions for commercial applications

15-100

Product flyers:



Wired Remote Control
Detailed info on BRC1E52A/B remote control

15-306

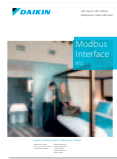

RTD modbus interface
Detailed info on RTD controls and applications

15-308



Round flow cassette
Detailed info on Round flow cassette

15-111



Concealed ceiling
Detailed info on Concealed ceiling units

15-102A



Fully Flat cassette
Detailed info on Fully flat cassette

15-107



Technical documentation:

Download all technical documentation such as engineering databooks, selection software, installation and operation manuals and service manuals directly from our extranet: my.daikin.eu



WALL MOUNTED UNIT



CEILING SUSPENDED CASSETTE



FULLY FLAT CASSETTE

Products overview *SkyAir*

























Type	Model		Product name		
	High COP, round flow cassette	<ul style="list-style-type: none"> - 360° air discharge for the highest efficiency and comfort - High COP cassette ensures top performance for commercial applications - Auto cleaning function ensures high efficiency - Intelligent sensors save energy and maximize comfort 		FCQHG-F	
	Round flow cassette	<ul style="list-style-type: none"> - 360° air discharge for optimum efficiency and comfort - Lowest installation height in the market! 35 to 71 class has a height of only 204mm - Auto cleaning function ensures high efficiency - Intelligent sensors save energy and maximize comfort 		FCQG-F ¹	
	Fully flat cassette	<ul style="list-style-type: none"> - Unique design in the market that integrates fully flat into the ceiling - Perfect integration in standard architectural ceiling tiles - Blend of iconic design and engineering excellence with a white or silver and white finish - Intelligent sensors save energy and maximize comfort - Flexibility to suit every room layout without changing the location of the unit! 		FFQ-C	
	4-way blow ceiling mounted unit	<ul style="list-style-type: none"> - Solution addressing the primary needs of small shops - Improved energy efficiency: up to A+ energy labels - Control several indoor units at the same time - Exclusively offered for pair applications 		ACQ-D	
Concealed ceiling	Small concealed ceiling unit	<ul style="list-style-type: none"> - Designed for hotel bedrooms and ensuring a good night rest - Compact dimensions enable installation in narrow ceiling voids - Easy mounting: drain pan can be located left or right of the unit - Discretely concealed in the ceiling: only the grilles are visible - Flexible installation as the air suction direction can be altered from rear to bottom suction 		FDBQ-B	
	Slim concealed ceiling unit	<ul style="list-style-type: none"> - Slim design for flexible installation - Medium external static pressure up to 40Pa - Small capacity unit developed for small of well insulated rooms 		FDXS-F (9)	
	Concealed ceiling unit with medium ESP	<ul style="list-style-type: none"> - Optimum comfort guaranteed no matter the length of ductwork or type of grilles - Multiple fan curves available for specific ductwork - Top efficiency in the market and lowest sound levels in the market! - Compact dimensions (only 245mm!) enable installation in narrow ceiling voids - Medium external static pressure up to 150Pa 		FBQ-D ¹	
	Concealed ceiling unit with high ESP	<ul style="list-style-type: none"> - ESP up to 200Pa, ideal for large sized buildings - Discretely concealed in the ceiling: only the grilles are visible - Possibility to change ESP via wired remote control allows optimisation of the supply air volume - Flexible installation as the air suction direction can be altered from rear to bottom suction 		FDQ-C	
	Concealed ceiling unit with high ESP	<ul style="list-style-type: none"> - ESP up to 250Pa, Ideal for extra large sized spaces - Blends unobtrusively with any interior décor: only the suction and discharge grilles are visible - Up to 26.4kW in heating mode 		FDQ-B ¹	
	Concealed ceiling unit	<ul style="list-style-type: none"> - Ideal for medium sized shops with false ceilings - Discretely concealed in the ceiling: only the grilles are visible - Best protection against possible water leakage 		ABQ-C	
Wall mounted	Wall mounted unit	<ul style="list-style-type: none"> - For rooms with no false ceilings nor free floor space - The air is comfortably spread up- and downwards thanks to 5 different discharge angles - Easy maintenance as this can be done from the front of the unit 		FAQ-C	
Ceiling suspended	Ceiling suspended unit	<ul style="list-style-type: none"> - For wide rooms with no false ceilings nor free floor space - Ideal for comfortable air flow in wide rooms thanks to Coanda effect - Even rooms with ceilings up to 3.8m can be heated up or cooled down very easily! - Can be mounted in corners or narrow spaces without any problem 		FHQ-C ¹	
	Ceiling suspended unit	<ul style="list-style-type: none"> - For wide rooms with no false ceilings nor free floor space - Guarantees a stable temperature 		AHQ-C	
	4-way blow ceiling suspended unit	<ul style="list-style-type: none"> - Unique Daikin unit for high rooms with no false ceilings nor free floor space - Even rooms with ceilings up to 3.5m can be heated up or cooled down very easily! - Flexibility to suit every room layout without changing the location of the unit! - Optimum comfort guaranteed with automatic air flow adjustment to the required load - The air is comfortably spread up- and downwards thanks to 5 different discharge angles 		FUQ-C ¹	
Floor standing	Floor standing unit	<ul style="list-style-type: none"> - For spaces with high ceilings - Ideal solution for commercial spaces with no or narrow false ceilings - Even rooms with very high ceilings can be heated up or cooled down very easily! - Guarantees a stable temperature 		FVQ-C	
	Concealed floor standing unit	<ul style="list-style-type: none"> - Designed to be concealed in walls, only grilles remain visible - Slimmest unit on the market with a depth of only 200mm! - Both window sill or ducted installation are possible thanks to sufficient ESP - Whisper quiet operation allows installation in any location 		FNQ-A	

1) Twin, triple, double twin application is only possible up to 125 class

Capacity class (kW)

25	35	50	60	71	100	125	140	200	250
				•	•	•	•		
	•	•	•	•	•	•	•		
•	•	•	•						
				•	•	•	•		
•									
•	•	•	•						
	•	•	•	•	•	•	•		
						•			
								•	•
				•	•	•	•		
				•	•				
	•	•	•	•	•	•	•		
				•	•	•	•		
				•	•	•			
				•	•	•	•		
•	•	•	•						

Benefits overview **SkyAir**

We care	 Seasonal efficiency - Smart use of energy	Seasonal efficiency gives a more realistic indication on how efficient air conditioners operate over an entire heating or cooling season.
	 Inverter technology	In combination with inverter controlled outdoor units
	 Home leave operation	During absence, the indoor temperature can be maintained at a certain level.
	 Fan only	The air conditioner can be used as fan, blowing air without cooling or heating.
	 Auto cleaning filter	The filter automatically cleans itself once per day. Simplicity of upkeep means optimum energy efficiency and maximum comfort without the need for expensive or time-consuming maintenance.
	 Floor and presence sensor	The presence sensor directs the air away from any person detected in the room, when the air flow control is on. The floor sensor detects the average floor temperature and ensures an even temperature distribution between ceiling and floor.
Comfort	 Draught prevention	When starting to warm up or when the thermostat is off, the air discharge direction is set horizontally and the fan to low speed, to prevent draught. After warming up, air discharge and fan speed are set as desired.
	 Whisper quiet	Daikin indoor units are whisper quiet. Also the outdoor units are guaranteed not to disturb the quiet of the neighbourhood.
	 Auto cooling-heating changeover	Automatically selects cooling or heating mode to achieve the set temperature.
Air treatment	 Air filter	Removes airborne dust particles to ensure a steady supply of clean air.
Humidity control	 Dry programme	Allows humidity levels to be reduced without variations in room temperature.
Air flow	 Ceiling soiling prevention	A special function prevents air blowing out too long in horizontal position, to prevent ceiling stains.
	 Vertical auto swing	Possibility to select automatic vertical moving of the air discharge louvre, for uniform air flow and temperature distribution.
	 Fan speed steps	Allows to select up to the given number of fan speed.
	 Individual flap control	Individual flap control via the wired remote controller makes it simple to fix the position of each flap individually, to suit any new room configuration. Optional closure kits are available as well.
Remote control & timer	 Weekly timer	Timer can be set to start operation anytime on a daily or weekly basis
	 Infrared remote control	Infrared remote control with LCD to start, stop and regulate the air conditioner from a distance.
	 Wired remote control	Wired remote control to start, stop and regulate the air conditioner from a distance.
	 Centralised control	Centralised control to start, stop and regulate several air conditioners from one central point.
Other functions	 Infrastructure cooling	Remove in a reliable, efficient and flexible way the heat constantly generated by the IT and server equipment to ensure maximum uptime while offering the best return on investment.
	 Auto-restart	The unit restarts automatically at the original settings after power failure.
	 Self-diagnosis	Simplifies maintenance by indicating system faults or operating anomalies.
	 Drain pump kit	Facilitates condensation draining from the indoor unit.
	 Twin/triple/double twin application	2, 3 or 4 indoor units can be connected to only 1 outdoor unit even if they have different capacities. All indoor units operate within the same mode (cooling or heating) from one remote control.
	 Multi model application	Up to 5 indoor units (even different capacities) can be connected to a single outdoor unit. All indoor units can individually be operated within the same mode.
 VRV for residential application	Up to 9 indoor units (even different capacities and up to 71 class) can be connected to a single outdoor unit. All indoor units can individually be operated within the same mode.	

Ceiling mounted cassette units				Concealed ceiling units						Ceiling suspended units		4-Way blow ceiling suspended unit	Wall mounted unit	Floor standing units	
FCQH-G-F	FCQG-F	FFQ-C	ACQ-D	FDBQ-B	FDXS-F(9)	FBQ-D	FDQ-C	FDQ-B	ABQ-C	FHQ-C	AHQ-C	FUQ-C	FAQ-C	FVQ-C	FNQ-A
•	•	•	•	•		•	•		•	•	•	•	•	•	•
•	•	•	•	•		•	•	•	•	•	•	•	•	•	•
•	•	•		•		•	•	•		•	•	•	•	•	•
•	•	•	•	•	•	•	•	•	•	•	•	•	•	•	•
•	•														
•	•	•													
•	•	•	•	•		•						•			
•	•	•		•		•									
•	•	•	•	•	•	•	•	•	•	•	•	•	•	•	•
•	•	•	•	•	•	•	•	•	•	•	•	•	•	•	•
•	•	•		•	•	•	•			•		•	•	•	•
•	•	•													
•	•	•													
•	•	•	•	•	•	•	•	•	•	•	•	•	•	•	•
3	3	3	4	2	3	3	3	2	3	3	3	3	3	3	2
•	•	•										•			
•	•	•	•	•	•	•	•	•	•	•	•	•	•	•	•
optional	optional	optional	standard		depending on controller optional	optional				optional	standard	optional	optional		optional
optional	optional	optional	optional	optional	optional	optional	optional	optional	standard	optional	optional	optional	optional	optional	optional
optional	optional	optional			optional	optional	optional	optional		optional		optional	optional	optional	optional
•	•	•				•				•		•	•	•	
•	•	•	•	•	•	•	•	•	•	•	•	•	•	•	•
•	•	•	•	•	•	•	•	•	•	•	•	•	•	•	•
standard	standard	standard	standard			standard	standard			optional		standard	optional		
•	•	•				•	•	•		•		•	•		•
	•	•		•	•	•				•					•
	•	•		•		•				•					•

FCQG-F/FCQHG-F/FXFQ-A

Round flow cassette

Why choose a round flow cassette?

- 360° air discharge for optimum efficiency and comfort in shops, offices and restaurants.
- Unique auto-cleaning panel.

Unique functions which help save costs

› Daikin was the first company to launch a cassette using the round flow principle with sensors* and a unique auto-cleaning panel*.

... More energy efficient than any other

› The auto-cleaning panel* means:

- Running costs are reduced by 50% compared with standard solutions thanks to automatic daily filter cleaning.
- Less time is required to maintain the filter: dust can be removed easily with a vacuum cleaner without opening the unit.
- For fine dust applications (i.e. clothing shops) a finer mesh filter (BYCQ140DGF) ensures consistent, optimum performance.
- Round flow cassette - overview decoration panels

BYCQ140DG	BYCQ140DGF	BYCQ140DW	BYCQ140D
Auto-cleaning panel	auto-cleaning panel with fine mesh filter	White panel	Standard panel
White with grey louvers	White with grey louvers	Full white	White with grey louvers

› Thanks to presence and floor sensors*, the unit changes its setpoint or switches off completely, if there are no people in the room, resulting in energy savings of up to 27%.

Dust can be removed easily with a vacuum cleaner without opening the unit.

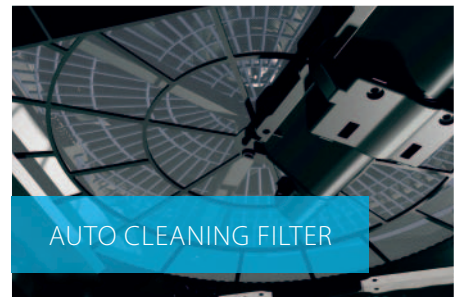
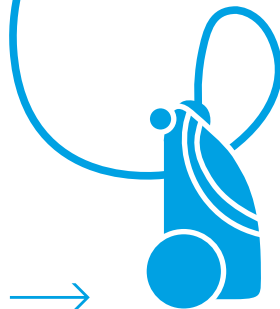
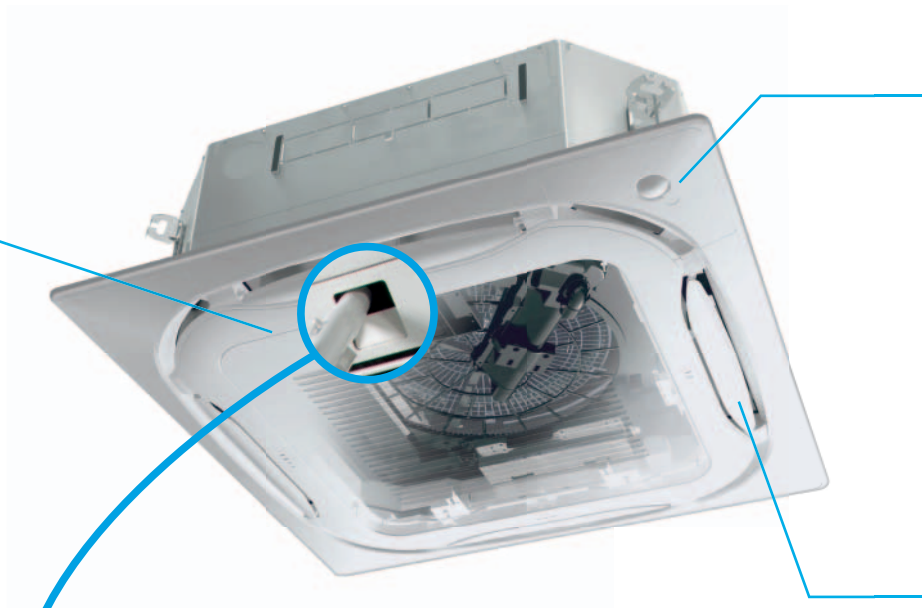

References

Wolverhampton, UK
Running costs were reduced by up to 50% compared with standard solutions thanks to daily filter cleaning.

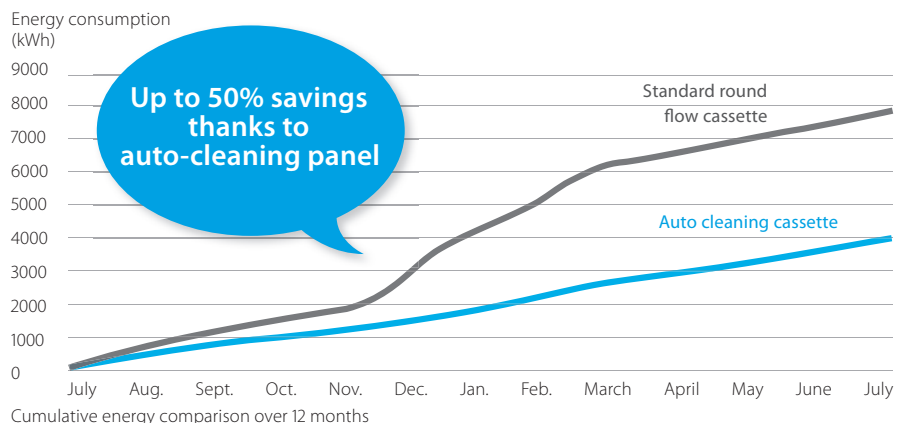



... And improved comfort

- › 360° air flow discharge pattern.
- › The presence sensor* directs the air away from anyone it detects in the room.
- › The floor sensor* detects the average floor temperature and ensures an even temperature distribution between the ceiling and the floor.



* available as an option

Flexible installation

- › Flaps can be individually controlled or closed using the wired remote control, to suit room configuration. Optional closure kits are also available.

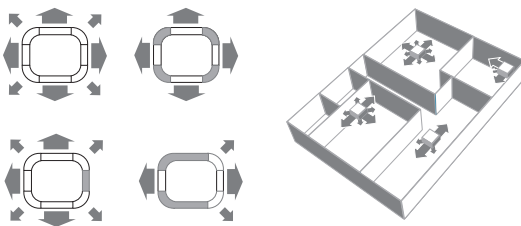

Benefits for the installer

- › Product with unique functions in this market.
- › Less time needed for onsite maintenance.
- › Use the controller to individually open or close any of the four flaps to easily adapt to a changing room layout.
- › Easy set-up of the sensor option to improve comfort and save energy.

Benefits for the consultant

- › Product with unique functions in this market.
- › Designed for use in all types and sizes of commercial offices and retail environments.
- › Ideal product for improving BREEAM score/EPDB in combination with Sky Air Seasonal Smart or VRV IV heat pump units.

Benefits for the end user

- › Designed for use in all types and sizes of commercial offices and retail environments.
- › Perfect environment conditions: no more draughts or cold feet.
- › Save up to 50% on running costs with the auto-cleaning panel, which also facilitates maintenance!
- › Your customers can save up to 27% on their energy bills thanks to the sensor option.
- › Flexible use of space thanks to individual flap control.

Marketing tools

- › Visit the website: www.daikineurope.com/minisite/round-flow-cassette/



www.youtube.com/DaikinEurope



Round flow cassette

360° air discharge for optimum efficiency and comfort

Combination with Seasonal Classic ensures good value for money for all types of commercial applications

- › The round flow cassette provides a more comfortable environment and offers greater savings in energy consumption to shop, office and restaurant owners
- › Lowest installation height in the market: 204mm for class 71
- › Individual flap control: flexibility to suit every room layout without changing the location of the unit!
- › Modern style decoration panel is available in 3 different variations: white (RAL9010) with grey louvers, full white (RAL9010) or auto-cleaning panel
- › Daily automatic filter cleaning results in higher efficiency, comfort and lower maintenance costs. 2 filters available: standard filter and finer mesh filter (for fine-dust applications, e.g. clothing shops).

- › Two optional intelligent sensors improve energy efficiency and comfort.
- › No optional adapter needed for DIII-connection, link your unit into the wider building management system
- › Branch duct discharge allows to optimize air distribution in irregular shaped rooms or to supply air to small adjacent rooms
- › Reduced energy consumption thanks to specially developed small tube heat exchanger, DC fan motor and drain pump
- › Standard drain pump with 850mm lift increases flexibility and installation speed

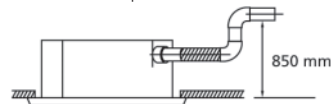

Efficiency data		FCQG + RZQSG		71F + 71L3V1	100F + 100L9V1	125F + 125L9V1	140F + 140L9V1	100F + 100L8Y1	125F + 125L8Y1	140F + 140LY1			
Cooling capacity	Nom.	kW		6.8	9.5	12.0	13.4	9.5	12.0	13.4			
Heating capacity	Nom.	kW		7.5	10.8	13.5	15.5	10.8	13.5	15.5			
Power input	Cooling	Nom.	kW	2.12	2.88	3.74	4.45	2.88	3.74	4.45			
	Heating	Nom.	kW	2.08	3.05	3.96	4.54	3.05	3.96	4.54			
Seasonal efficiency (according to EN14825)	Cooling	Energy label		A++		A		A++		A			
		Pdesign		kW		6.80		9.50		12.00			
		SEER		kWh		6.10		6.50		5.30			
	Annual energy consumption		kWh		390		512		793		-		
	Heating (Average climate)	Energy label		A+		-		-		A+		-	
		Pdesign		kW		6.33		7.60		8.03		-	
SCOP		kWh		4.10		4.01		-		4.1			
Nominal efficiency	EER	kWh		2,162		2,596		2,804		-			
	COP	kWh		3.21		3.30		3.21		3.01			
	Annual energy consumption	kWh		1,060		1,440		1,870		2,225			
	Energy label	Cooling/Heating		A/A		A/B		-		A/B			
Indoor unit		FCQG		71F	100F	125F	140F	100F	125F	140F			
Dimensions	Unit	HeightxWidthxDepth	mm	204x840x840			246x840x840						
Weight	Unit	kg		21			24						
Decoration panel	Model	BYCQ140D7GFW1 - auto cleaning panel with fine mesh filter / BYCQ140D7GW1 - auto cleaning panel / BYCQ140D7W1W - full white / BYCQ140D7W1 - white with grey louvers											
	Colour	Pure White (RAL 9010)											
	Dimensions	HeightxWidthxDepth	mm 130x950x950 / 130x950x950 / 50x950x950 / 50x950x950										
Air filter	Type	Resin net with mold resistance											
	Fan - Air flow rate	Cooling	High/Nom./Low	m ³ /min	15.0/12.1/9.1	22.8/17.6/12.4	26.0/19.2/12.4		22.8/17.6/12.4	26.0/19.2/12.4			
Sound power level	Cooling	dBA		51	54	58		54	58				
	Heating	dBA		51	54	58		54	58				
Sound pressure level	Cooling	High/Nom./Low	dBA	33/31/28	37/33/29	41/35/29		37/33/29	41/35/29				
	Heating	High/Nom./Low	dBA	33/31/28	37/33/29	41/35/29		37/33/29	41/35/29				
Control systems	Infrared remote control	BRC7FA532F											
	Wired remote control	BRC1D52 / BRC1E52A/B											
Power supply	Phase / Frequency / Voltage	1~ / 50 / 220-240											
Outdoor unit		RZQSG		71L3V1	100L9V1	125L9V1	140L9V1	100L8Y1	125L8Y1	140LY1			
Dimensions	Unit	HeightxWidthxDepth	mm	770x900x320	990x940x320	1,430x940x320	990x940x320	1,430x940x320	1,430x940x320	1,430x940x320			
Weight	Unit	kg		67	72	74	95	82	101				
Sound power level	Cooling	dBA		65	70		69	70	69				
	Heating	Nom./Silent operation	dBA	49/47	53/-	54/-	53/-	54/-	58	54			
Sound pressure level	Cooling	Nom.	dBA	51	57	58	54	57	58	54			
	Heating	Nom.	dBA	51	57	58	54	57	58	54			
Operation range	Cooling	Ambient	Min.-Max. °CDB	-15~46									
	Heating	Ambient	Min.-Max. °CWB	-15~-15.5									
Refrigerant	Type/Charge/GWP	kg/TCO ₂ eq		R-410A/2.75/5.7/2,087.5	R-410A/2.9/6.1/2,087.5	R-410A/4.0/8.4/2,087.5	R-410A/2.9/6.1/2,087.5	R-410A/4.0/8.4/2,087.5	R-410A/4.0/8.4/2,087.5				
Piping connections	Liquid	OD		mm 9.52									
	Gas	OD		mm 15.9									
	Piping length	OU - IU	Max.	m	50								
		System	Equivalent	m	70								
	Chargeless		m		30								
	Additional refrigerant charge		kg/m		See installation manual								
Level difference	IU - OU	Max.	m	15									
	IU - IU	Max.	m	30.0									
Power supply	Phase / Frequency / Voltage	Hz / V		1~ / 50 / 220-240			3N~ / 50 / 380-415						
Current - 50Hz	Maximum fuse amps (MFA)	A		25	40		20		25				

(1) EER/COP according to Eurovent 2012, for use outside EU only (2) MFA is used to select the circuit breaker and the ground fault circuit interrupter (earth leakage circuit breaker). For more detailed information on each combination, please refer to the electrical data drawing. (3) The BYCQ140D7W1W has white insulations. Be informed that formation of dirt on white insulation is visibly stronger and that it is consequently not advised to install the BYCQ140D7W1W decoration panel in environments exposed to concentrations of dirt. (4) BYCQ140D7W1: pure white standard panel with grey louvers; BYCQ140D7W1W: pure white standard panel with white louvers; BYCQ140D7GW1: pure white auto cleaning panel.



Round flow cassette

360° air discharge for optimum efficiency and comfort

Combination with Seasonal Smart ensures best in class quality, highest efficiency and performance



Efficiency data			FCQG + RZQG	71F + 71L9V1	100F + 100L9V1	125F + 125L9V1	140F + 140L9V1	71F + 71L8Y1	100F + 100L8Y1	125F + 125L8Y1	140F + 140L1Y1	
Cooling capacity	Nom.		kW	6.8	9.5	12.0	13.4	6.8	9.5	12.0	13.4	
Heating capacity	Nom.		kW	7.5	10.8	13.5	15.5	7.5	10.8	13.5	15.5	
Power input	Cooling	Nom.	kW	2.01	2.45	3.22	-	2.01	2.45	3.22	4.17	
	Heating	Nom.	kW	1.89	2.60	3.72	-	1.89	2.60	3.72	4.30	
Seasonal efficiency (according to EN14825)	Cooling	Energy label		A++		A+	-	A++		A+	-	
		Pdesign	kW	6.80	9.50	12.00	-	6.8	9.5	12	-	
		SEER		6.80		6.00	-	6.8		6	-	
	Heating (Average climate)	Annual energy consumption	kWh	350	489	700	-	350	489	700	-	
		Energy label		A+		A++	A+	-	A+		A++	A+
		Pdesign	kW	6.33	11.30	12.66	-	6.33	11.3	12.66	-	
Nominal efficiency	EER	SCOP	kWh	4.20	4.61	4.10	-	4.2	4.61	4.1	-	
		Annual energy consumption	kWh	2,110	3,432	4,323	-	2,110	3,432	4,323	-	
Nominal efficiency	COP	EER		3.39	3.87	3.73	3.21	3.39	3.87	3.73	3.21	
		Annual energy consumption	kWh	3.97	4.15	3.63	3.61	3.97	4.15	3.63	3.61	
Energy label		Cooling/Heating		A/A		-	-	A/A		-	-	
Indoor unit			FCQG	71F	100F	125F	140F	71F	100F	125F	140F	
Dimensions	Unit	HeightxWidthxDpeth	mm	204x840x840		246x840x840		204x840x840		246x840x840		
Weight	Unit		kg	21		24		21		24		
Decoration panel	Model			BYCQ140D7GFW1 - auto cleaning panel with fine mesh filter / BYCQ140D7GW1 - auto cleaning panel / BYCQ140D7WIW - full white / BYCQ140D7W1 - white with grey louvers								
	Colour			Pure White (RAL 9010)								
	Dimensions	Unit	HeightxWidthxDpeth	mm	130x950x950 / 130x950x950 / 50x950x950							
Air filter	Weight	Unit	kg	10.3 / 10.3 / 5.4 / 5.4								
	Type			Resin net with mold resistance								
Fan - Air flow rate	Cooling	High/Nom./Low	m³/min	15.0/12.1/9.1	22.8/17.6/12.4	26.0/19.2/12.4	26.0/19.2/12.4	15.0/12.1/9.1	22.8/17.6/12.4	26.0/19.2/12.4	26.0/19.2/12.4	
	Heating	High/Nom./Low	m³/min	15.0/12.1/9.1	22.8/17.6/12.4	26.0/19.2/12.4	26.0/19.2/12.4	15.0/12.1/9.1	22.8/17.6/12.4	26.0/19.2/12.4	26.0/19.2/12.4	
Sound power level	Cooling		dB(A)	51	54	58	58	51	54	58	58	
	Heating		dB(A)	51	54	58	58	51	54	58	58	
Sound pressure level	Cooling	High/Nom./Low	dB(A)	33/31/28	37/33/29	41/35/29	41/35/29	33/31/28	37/33/29	41/35/29	41/35/29	
	Heating	High/Nom./Low	dB(A)	33/31/28	37/33/29	41/35/29	41/35/29	33/31/28	37/33/29	41/35/29	41/35/29	
Control systems	Infrared remote control			BRC7FA532F								
	Wired remote control			BRC1D52 / BRC1E52A/B								
Power supply	Phase / Frequency / Voltage		Hz / V	1~ / 50 / 220-240								
Outdoor unit			RZQG	71L9V1	100L9V1	125L9V1	140L9V1	71L8Y1	100L8Y1	125L8Y1	140L1Y1	
Dimensions	Unit	HeightxWidthxDpeth	mm	990x940x320		1,430x940x320		990x940x320		1,430x940x320		
Weight	Unit		kg	69		95		80		101		
Sound power level	Cooling		dB(A)	64	66	67	69	64	66	67	69	
	Heating		dB(A)	48	50	51	52	48	50	51	52	
Sound pressure level	Cooling	Nom.	dB(A)	50	52	53	53	50	52	53	53	
	Heating	Nom.	dB(A)	50	52	53	53	50	52	53	53	
Operation range	Cooling	Ambient	Min.-Max. °CDB	-15~50								
	Heating	Ambient	Min.-Max. °CWB	-20~-15.5								
Refrigerant	Type/Charge/GWP		kg/TCO ₂ eq	R-410A/2.9/6.1/2,087.5		R-410A/4.0/8.4/2,087.5		R-410A/2.9/6.1/2,087.5		R-410A/4.0/8.4/2,087.5		
Piping connections	Liquid	OD	mm	9.52								
	Gas	OD	mm	15.9								
Piping length	OU - IU	Max.	m	50		75		50		75		
	System	Equivalent	m	70		90		70		90		
Additional refrigerant charge	Chargeless		m	30								
	Level difference	IU - OU	Max.	See installation manual								
Power supply	IU - IU	Max.	m	30.0								
	IU - IU	Max.	m	0.5								
Power supply	Phase / Frequency / Voltage		Hz / V	1~ / 50 / 220-240				3N~ / 50 / 380-415				
Current - 50Hz	Maximum fuse amps (MFA)		A	25		40		16		25		

(1) EER/COP according to Eurovent 2012, for use outside EU only (2) MFA is used to select the circuit breaker and the ground fault circuit interrupter (earth leakage circuit breaker). For more detailed information on each combination, please refer to the electrical data drawing. (3) The BYCQ140D7WIW has white insulations. Be informed that formation of dirt on white insulation is visibly stronger and that it is consequently not advised to install the BYCQ140D7WIW decoration panel in environments exposed to concentrations of dirt.



Round flow cassette

360° air discharge for optimum efficiency and comfort

Combination with split outdoor units is ideal for small retail, offices or residential applications

- › The round flow cassette provides a more comfortable environment and offers greater savings in energy consumption to shop, office and restaurant owners
- › Lowest installation height in the market: 204mm for class 71
- › Individual flap control: flexibility to suit every room layout without changing the location of the unit!
- › Modern style decoration panel is available in 3 different variations: white (RAL9010) with grey louvers, full white (RAL9010) or auto-cleaning panel
- › Daily automatic filter cleaning results in higher efficiency, comfort and lower maintenance costs. 2 filters available: standard filter and finer mesh filter (for fine-dust applications, e.g. clothing shops).
- › Two optional intelligent sensors improve energy efficiency and comfort.
- › No optional adapter needed for DIII-connection, link your unit into the wider building management system
- › Branch duct discharge allows to optimize air distribution in irregular shaped rooms or to supply air to small adjacent rooms
- › Reduced energy consumption thanks to specially developed small tube heat exchanger, DC fan motor and drain pump



- › Standard drain pump with 850mm lift increases flexibility and installation speed

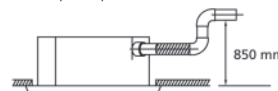

Efficiency data		FCQG + RXS	35F + 35L3	50F + 50L	60F + 60L	
Cooling capacity	Min./Nom./Max.	kW	1.3/3.4/4.0	1.7/5.0/5.3	1.7/5.7/5.7	
Heating capacity	Min./Nom./Max.	kW	1.3/4.20/5.2	1.7/6.00/6.0	1.7/7.0/7.0	
Power input	Cooling	Min./Nom./Max.	0.400/0.909/1.100	-1.410/-	-1.640/-	
	Heating	Min./Nom./Max.	0.230/1.200/1.840	-1.620/-	-1.990/-	
Seasonal efficiency (according to EN14825)	Cooling	Energy label		A++		
		Pdesign	kW	3.50	5.00	5.70
		SEER		6.35	6.48	6.22
	Heating (Average climate)	Annual energy consumption	kWh	193	270	321
		Energy label		A++		A+
		Pdesign	kW	3.32	4.36	4.71
Nominal efficiency	EER	SCOP	4.90	4.29	4.00	
		Annual energy consumption	kWh	949	1,426	1,646
	COP	EER	3.74	3.55	3.48	
		Annual energy consumption	kWh	3.50	3.7	3.52
Energy label	Cooling/Heating	A/B	A/A	A/B		

Indoor unit		FCQG	35F	50F	60F
Dimensions	Unit	HeightxWidthxDepth	mm	204x840x840	
Weight	Unit		kg	18	19
Decoration panel	Model	BYCQ140D7GFW1 - auto cleaning panel with fine mesh filter / BYCQ140D7GW1 - auto cleaning panel / BYCQ140D7W1W - full white / BYCQ140D7W1 - white with grey louvers			
	Colour	Pure White (RAL 9010)			
	Dimensions	HeightxWidthxDepth	mm	130x950x950 / 130x950x950 / 50x950x950 / 50x950x950	
Air filter	Type	Weight	kg	10.3 / 10.3 / 5.4 . 5.4	
				Resin net with mold resistance	
Fan - Air flow rate	Cooling	High/Nom./Low	m ³ /min	12.5/10.6/8.7	12.6/10.7/8.7
	Heating	High/Nom./Low	m ³ /min	12.5/10.6/8.7	12.6/10.7/8.7
Sound power level	Cooling		dB(A)	49	51
	Heating		dB(A)	49	51
Sound pressure level	Cooling	High/Nom./Low	dB(A)	31/29/27	33/31/28
	Heating	High/Nom./Low	dB(A)	31/29/27	33/31/28
Control systems	Infrared remote control			BRC7FA532F	
	Wired remote control			BRC1D52 / BRC1E52A/B	
Power supply	Phase / Frequency / Voltage	Hz / V		1~ / 50 / 220-240	

Outdoor unit		RXS	35L3	50L	60L	
Dimensions	Unit	HeightxWidthxDepth	mm	550x765x285	735x825x300	
Weight	Unit		kg	34	47	
Sound power level	Cooling		dB(A)	61	62	
	Heating		dB(A)	61	62	
Sound pressure level	Cooling	High/Low/Silent operation	dB(A)	48/-/44	48/44/-	
	Heating	High/Low/Silent operation	dB(A)	48/-/45	48/45/-	
Operation range	Cooling	Ambient Min.-Max.	°CDB	-10~46	49/46/-	
	Heating	Ambient Min.-Max.	°CWB	-15~18	49/46/-	
Refrigerant	Type/Charge/GWP	kg/TCO ₂ eq	R-410A/1.2/2.5/2,087.5	R-410A/1.7/3.5/2,087.5	R-410A/1.5/3.1/2,087.5	
Piping connections	Liquid	OD	mm	6.35		
		Gas	mm	9.5	12.70	
	Piping length	OU - IU	Max.	m	20	30
		System	Chargeless	m	10	-
	Additional refrigerant charge		kg/m	0.02 (for piping length exceeding 10m)		
Level difference	IU - OU	Max.	m	15	20.0	
Power supply	Phase / Frequency / Voltage	Hz / V		1~ / 50 / 220-240	1~ / 50 / 220-230-240	
Current - 50Hz	Maximum fuse amps (MFA)	A		16	20	

(1) EER/COP according to Eurovent 2012, for use outside EU only (2) MFA is used to select the circuit breaker and the ground fault circuit interrupter (earth leakage circuit breaker). For more detailed information on each combination, please refer to the electrical data drawing. (3) The BYCQ140D7W1W has white insulations. Be informed that formation of dirt on white insulation is visibly stronger and that it is consequently not advised to install the BYCQ140D7W1W decoration panel in environments exposed to concentrations of dirt. (4) BYCQ140D7W1: pure white standard panel with grey louvers; BYCQ140D7W1W: pure white standard panel with white louvers; BYCQ140D7GW1: pure white auto cleaning panel.



Round flow cassette

High COP, round flow cassette

360° air discharge for optimum efficiency and comfort

Combination with Seasonal Classic ensures good value for money for all types of commercial applications

- › High COP cassette ensures top performance, great savings in energy consumption and a comfortable environment for commercial applications
- › Lowest installation height in the market: 204mm for class 71
- › Individual flap control: flexibility to suit every room layout without changing the location of the unit!
- › Modern style decoration panel is available in 3 different variations: white (RAL9010) with grey louvers, full white (RAL9010) or auto-cleaning panel
- › Daily automatic filter cleaning results in higher efficiency, comfort and lower maintenance costs. 2 filters available: standard filter and finer mesh filter (for fine-dust applications, e.g. clothing shops).

- › Two optional intelligent sensors improve energy efficiency and comfort.
- › No optional adapter needed for DIII-connection, link your unit into the wider building management system
- › Branch duct discharge allows to optimize air distribution in irregular shaped rooms or to supply air to small adjacent rooms
- › Reduced energy consumption thanks to specially developed small tube heat exchanger, DC fan motor and drain pump
- › Standard drain pump with 850mm lift increases flexibility and installation speed

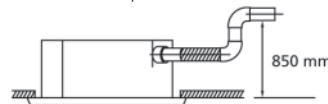

Efficiency data		FCQHG + RZQSG	71F + 71L3V1	100F + 100L9V1	125F + 125L9V1	140F + 140L9V1	100F + 100L8Y1	125F + 125L8Y1	140F + 140LY1	
Cooling capacity	Nom.	kW	6.8	9.5	12.0	13.4	9.5	12.0	13.4	
Heating capacity	Nom.	kW	7.5	10.8	13.5	15.5	10.8	13.5	15.5	
Power input	Cooling	Nom.	1.94	2.57	3.71	4.17	2.57	3.71	4.17	
	Heating	Nom.	1.83	2.51	3.60	4.29	2.51	3.60	4.29	
Seasonal efficiency (according to EN14825)	Cooling	Energy label	A++		A		A++		A	
		Pdesign	kW	6.80	9.50	12.00	-	9.5	12	-
		SEER		6.50	6.70	5.40	-	6.7	5.4	-
	Heating (Average climate)	Annual energy consumption	kWh	366	497	778	-	497	778	-
		Energy label	A+		-		A+		-	
		Pdesign	kW	7.60	8.03	-	-	8.03	-	-
Nominal efficiency	EER	SCOP	4.15	4.30	4.10	-	4.3	4.1	-	
		Annual energy consumption	kWh	2,563	2,615	2,742	-	2,615	2,742	-
	COP	EER	3.50	3.70	3.23	3.21	3.70	3.23	3.21	
		COP	4.10	4.30	3.75	3.61	4.30	3.75	3.61	
Annual energy consumption	kWh	970	1,285	1,855	-	1,285	1,855	-		
	Energy label	Cooling/Heating	A/A		-		A/A		-	

Indoor unit		FCQHG	71F	100F	125F	140F	100F	125F	140F		
Dimensions	Unit	HeightxWidthxDepth	288x840x840								
Weight	Unit	kg	25					26			
Decoration panel	Model	BYCQ140D7GFW1 - auto cleaning panel with fine mesh filter / BYCQ140D7GW1 - auto cleaning panel / BYCQ140D7W1W - full white / BYCQ140D7W1 - white with grey louvers									
	Colour	Pure White (RAL 9010)									
	Dimensions	HeightxWidthxDepth	130x950x950 / 130x950x950 / 50x950x950 / 50x950x950								
Air filter	Weight	kg	10.3 / 10.3 / 5.4 / 5.4								
	Type	Resin net with mold resistance									
Fan - Air flow rate	Cooling	High/Nom./Low	m ³ /min	21.2/16.7/12.2	32.3/25.7/19.0	33.5/26.7/19.9	33.5/27.3/21.1	32.3/25.7/19.0	33.5/26.7/19.9	33.5/27.3/21.1	
	Heating	High/Nom./Low	m ³ /min	21.2/16.7/12.2	32.3/25.7/19.0	33.5/26.7/19.9	33.5/27.3/21.1	32.3/25.7/19.0	33.5/26.7/19.9	33.5/27.3/21.1	
Sound power level	Cooling		dBA	53	61						
	Heating		dBA	53	61						
Sound pressure level	Cooling	High/Nom./Low	dBA	36/33/29	44/39/33	45/40/35	45/41/37	44/39/33	45/40/35	45/41/37	
	Heating	High/Nom./Low	dBA	36/33/29	44/39/33	45/40/35	45/41/37	44/39/33	45/40/35	45/41/37	
Control systems	Infrared remote control	BRC7FA532F									
	Wired remote control	BRC1D52 / BRC1E52A/B									
Power supply	Phase / Frequency / Voltage	Hz / V	1~ / 50 / 220-240								

Outdoor unit		RZQSG	71L3V1	100L9V1	125L9V1	140L9V1	100L8Y1	125L8Y1	140LY1	
Dimensions	Unit	HeightxWidthxDepth	770x900x320	990x940x320	1,430x940x320	990x940x320	1,430x940x320			
Weight	Unit	kg	67	72	74	95	82	101		
Sound power level	Cooling		dBA	65	70	69	70	69		
	Sound pressure level	Cooling	Nom./Silent operation	dBA	49/47	53/-	54/-	53/-	54/-	53/-
Operation range	Heating	Nom.	dBA	51	57	58	54	57	58	54
	Night quiet mode	Level 1	dBA	-	49					
Refrigerant	Cooling	Ambient	Min.-Max. °CDB	-15~46						
	Heating	Ambient	Min.-Max. °CWB	-15~-15.5						
Piping connections	Type/Charge/GWP	kg/TCO ₂ eq	R-410A/2.75/5.7/2,087.5	R-410A/2.9/6.1/2,087.5	R-410A/4.0/8.4/2,087.5	R-410A/2.9/6.1/2,087.5	R-410A/4.0/8.4/2,087.5			
	Liquid	OD	mm	9.52						
		Gas	OD	mm	15.9					
	Piping length	OU - IU	Max.	m	50					
		System	Equivalent	m	70					
		Chargeless	m	30						
	Additional refrigerant charge	kg/m	See installation manual							
	Level difference	IU - OU	Max.	m	15	30.0				
IU - IU		Max.	m	0.5						
Power supply	Phase / Frequency / Voltage	Hz / V	1~ / 50 / 220-240				3N~ / 50 / 380-415			
Current - 50Hz	Maximum fuse amps (MFA)	A	25	40			20		25	

(1) EER/COP according to Eurovent 2012, for use outside EU only (2) MFA is used to select the circuit breaker and the ground fault circuit interrupter (earth leakage circuit breaker). For more detailed information on each combination, please refer to the electrical data drawing. (3) The BYCQ140D7W1W has white insulations. Be informed that formation of dirt on white insulation is visibly stronger and that it is consequently not advised to install the BYCQ140D7W1W decoration panel in environments exposed to concentrations of dirt. (4) BYCQ140D7W1: pure white standard panel with grey louvers; BYCQ140D7W1W: pure white standard panel with white louvers; BYCQ140D7GW1: pure white auto cleaning panel.



High COP, round flow cassette

360° air discharge for optimum efficiency and comfort

Combination with Seasonal Classic ensures good value for money for all types of commercial applications



Efficiency data			FCQHG + RZQG	71F + 71L9V1	100F + 100L9V1	125F + 125L9V1	140F + 140L9V1	71F + 71L8Y1	100F + 100L8Y1	125F + 125L8Y1	140F + 140L1Y1	
Cooling capacity	Nom.		kW	6.8	9.5	12.0	13.4	6.8	9.5	12.0	13.4	
Heating capacity	Nom.		kW	7.5	10.8	13.5	15.5	7.5	10.8	13.5	15.5	
Power input	Cooling	Nom.	kW	1.66	2.15	3.00	4.00	1.66	2.15	3.00	4.00	
	Heating	Nom.	kW	1.56	2.16	3.07	3.77	1.56	2.16	3.07	3.77	
Seasonal efficiency (according to EN14825)	Cooling	Energy label		A++				-				
		Pdesign	kW	6.80	9.50	12.00	-	6.8	9.5	12	-	
		SEER		7.00				6.61				
	Heating (Average climate)	Annual energy consumption	kWh	340	475	636	-	340	475	636	-	
		Energy label		A+			A++			-		
		Pdesign	kW	7.60	11.30	12.66	-	7.6	11.3	12.66	-	
Nominal efficiency	EER	COP		4.09	4.42	4.00	3.35	4.09	4.42	4.00	3.35	
		Annual energy consumption	kWh	830	1,075	1,500	-	830	1,075	1,500	-	
		Energy label	Cooling/Heating	A/A		-		A/A		-		

Indoor unit			FCQHG	71F	100F	125F	140F	71F	100F	125F	140F
Dimensions	Unit	HeightxWidthxDpeth	mm	288x840x840							
Weight	Unit		kg	25	26		25	26			
Decoration panel	Model			BYCQ140D7GFW1 - auto cleaning panel with fine mesh filter / BYCQ140D7GW1 - auto cleaning panel / BYCQ140D7WIW - full white / BYCQ140D7W1 - white with grey louvers							
	Colour			Pure White (RAL 9010)							
	Dimensions	HeightxWidthxDpeth	mm	130x950x950 / 130x950x950 / 50x950x950 / 50x950x950							
Air filter	Weight		kg	10.3 / 10.3 / 5.4 / 5.4							
	Type			Resin net with mold resistance							
Fan - Air flow rate	Cooling	High/Nom./Low	m ³ /min	21.2/16.7/12.2	32.3/25.7/19.0	33.5/26.7/19.9	33.5/27.3/21.1	21.2/16.7/12.2	32.3/25.7/19.0	33.5/26.7/19.9	33.5/27.3/21.1
	Heating	High/Nom./Low	m ³ /min	21.2/16.7/12.2	32.3/25.7/19.0	33.5/26.7/19.9	33.5/27.3/21.1	21.2/16.7/12.2	32.3/25.7/19.0	33.5/26.7/19.9	33.5/27.3/21.1
Sound power level	Cooling		dB(A)	53	61		53	61			
	Heating		dB(A)	53	61		53	61			
Sound pressure level	Cooling	High/Nom./Low	dB(A)	36/33/29	44/39/33	45/40/35	45/41/37	36/33/29	44/39/33	45/40/35	45/41/37
	Heating	High/Nom./Low	dB(A)	36/33/29	44/39/33	45/40/35	45/41/37	36/33/29	44/39/33	45/40/35	45/41/37
Control systems	Infrared remote control			BRC7FA532F							
	Wired remote control			BRC1D52 / BRC1E52A/B							
Power supply	Phase / Frequency / Voltage		Hz / V	1~ / 50 / 220-240							

Outdoor unit			RZQG	71L9V1	100L9V1	125L9V1	140L9V1	71L8Y1	100L8Y1	125L8Y1	140L1Y1	
Dimensions	Unit	HeightxWidthxDpeth	mm	990x940x320	1,430x940x320			990x940x320	1,430x940x320			
Weight	Unit		kg	69	95		80	101				
Sound power level	Cooling		dB(A)	64	66	67	69	64	66	67	69	
	Heating		dB(A)	48	50	51	52	48	50	51	52	
Sound pressure level	Cooling	Nom.	dB(A)	50	53		50	53				
	Heating	Nom.	dB(A)	50	53		50	53				
Operation range	Cooling	Ambient	Min.-Max. °CDB	-15~50								
	Heating	Ambient	Min.-Max. °CWB	-20~15.5								
Refrigerant	Type/Charge/GWP		kg/TCO ₂ eq	R-410A/2.9/6.1/2,087.5	R-410A/4.0/8.4/2,087.5			R-410A/2.9/6.1/2,087.5	R-410A/4.0/8.4/2,087.5			
Piping connections	Liquid	OD	mm	9.52								
	Gas	OD	mm	15.9								
	Piping length	OU - IU	Max.	m	50	75		50	75			
		System	Equivalent	m	70	90		70	90			
		Chargeless		m	30							
Additional refrigerant charge			kg/m	See installation manual								
Level difference	IU - OU	Max.	m	30.0								
	IU - IU	Max.	m	0.5								
Power supply	Phase / Frequency / Voltage		Hz / V	1~ / 50 / 220-240				3N~ / 50 / 380-415				
Current - 50Hz	Maximum fuse amps (MFA)		A	25	40		16	25				

(1) EER/COP according to Eurovent 2012, for use outside EU only (2) MFA is used to select the circuit breaker and the ground fault circuit interrupter (earth leakage circuit breaker). For more detailed information on each combination, please refer to the electrical data drawing. (3) The BYCQ140D7WIW has white insulations. Be informed that formation of dirt on white insulation is visibly stronger and that it is consequently not advised to install the BYCQ140D7WIW decoration panel in environments exposed to concentrations of dirt.



FFQ-C / FXZQ-A



Fully Flat Cassette

Design & Genius in one

Why choose fully flat cassette

- › Unique design in the market that integrates fully flat into the ceiling
- › Advanced technology and top efficiency combined
- › Most quiet cassette available on the market



www.youtube.com/DaikinEurope



Marketing tools

- › Visit the website: www.daikineurope.com/fullyflat

Benefits for the installer

- › Unique product in the market!
- › Most quiet unit (25dBA)
- › The user-friendly remote control, available in several languages, enables the easy set-up of sensor option and control of the individual flap position
- › Meeting European design taste.

Benefits for the consultant

- › Unique product in the market!
- › Blends seamlessly in any modern office interior design
- › Ideal product to improve BREEAM score/EPBD in combination with Sky Air Seasonal Smart (FFQ-C) or VRV IV heat pump units (FXZQ-A).

Benefits for the end user

- › Engineering excellence and unique design in one
- › Most quiet unit (25dBA)
- › Perfect working conditions: no more cold draughts
- › Save up to 27% on your energy bill thanks to the optional sensors
- › Flexible usage of space and suits any room configuration thanks to individual flap control
- › User-friendly remote control, available in several languages.

Unique design

- › Designed by a European design office to fully meet the European taste.
- › Fully flat into the ceiling, leaving only 8mm.
- › Fully integrated in the one ceiling tile, enabling lights, speakers and sprinklers to be installed in adjoining ceiling tiles.
- › Decoration panel available in 2 colours (white and white-silver).



Differentiating in technology

Optional presence sensor

- › When the room is empty, it can adjust the set temperature or switch off the unit – saving energy.
- › When people are detected, the direction of the airflow is adapted to avoid cold draughts being directed towards occupants.

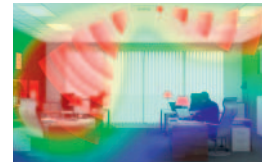

Optional floor sensor

- › Detects the temperature difference and re-directs the airflow to ensure even temperature distribution.

Top efficiency

- › Seasonal labels up to **A++***
- › When the room is empty, the sensor option can adjust the set temperature or switch off the unit – saving up to 27% energy.
- › Individual flap control: easily control one or more flaps via the wired remote controller (BRC1E52) when rearranging the room. When fully closing or blocking the flaps, the option “Sealing member of air discharge outlet” is needed.

* for FFQ25,35C in combination with RXS25,35L3



Most quiet unit in the market

- › Most silent cassette in the market (25dBA), important for office applications.



Fully flat cassette

Unique design in the market that integrates fully flat into the ceiling

- Combination with split outdoor units is ideal for small retail, offices or residential applications
- > Fully flat integration in standard architectural ceiling tiles, leaving only 8mm
- > Remarkable blend of iconic design and engineering excellence with an elegant finish in white or a combination of silver and white
- > Individual flap control: flexibility to suit every room layout without changing the location of the unit!
- > Two optional intelligent sensors improve energy efficiency and comfort.



- > No optional adapter needed for DIII-connection, link your unit into the wider building management system.
- > Branch duct discharge allows to optimize air distribution in irregular shaped rooms or to supply air to small adjacent rooms
- > Reduced energy consumption thanks to specially developed small tube heat exchanger, DC fan motor and drain pump
- > Standard drain pump with 675mm lift increases flexibility and installation speed

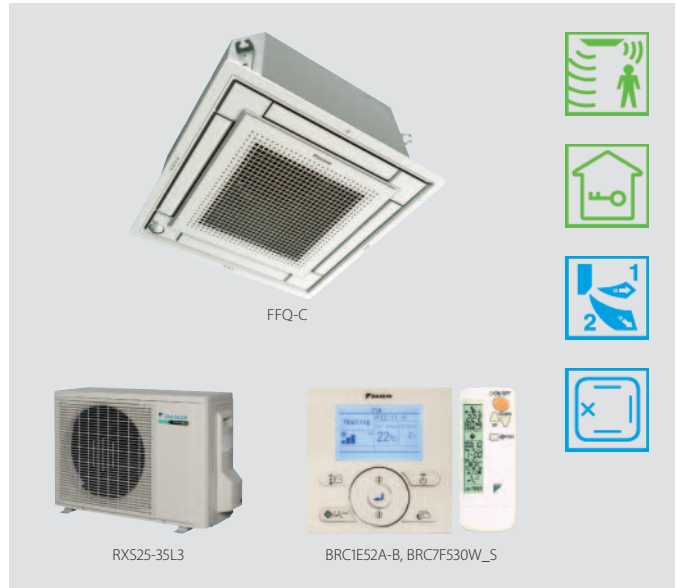
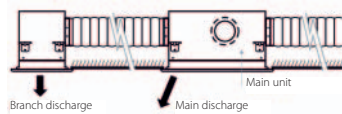

- > Fresh air intake integrated in the same system thus reducing installation cost as no additional ventilation is required

Fresh air intake opening in casing



Optional fresh air intake kit

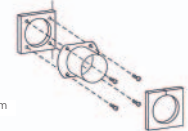

* Brings in up to 10% of fresh air into the room

* Allows larger quantities of fresh air to be bought in

Efficiency data		FFQ + RXS	25C + 25L3	35C + 35L3	50C + 50L	60C + 60L	
Cooling capacity	Min./Nom./Max.	kW	1.4/2.50/4.0	1.4/3.4/4.0	1.7/5.0/5.3	1.7/5.7/6.5	
Heating capacity	Min./Nom./Max.	kW	1.3/3.20/5.1	1.3/4.20/5.1	1.7/5.8/6.0	1.7/7.0/8.0	
Power input	Cooling	Min./Nom./Max.	0.360/0.551/1.470	0.360/0.899/1.470	-1.560/-	-1.890/-	
	Heating	Min./Nom./Max.	0.300/0.820/1.650	0.300/1.200/1.650	-1.660/-	-2.050/-	
Seasonal efficiency (according to EN14825)	Cooling	Energy label	A++		A+		
		Pdesign	kW	2.50	3.40	5.00	5.70
		SEER		6.11	6.32	5.93	5.71
	Heating (Average climate)	Annual energy consumption	kWh	143	188	295	349
		Energy label		A+		A	
		Pdesign	kW	2.31	3.10	3.84	3.96
Nominal efficiency	EER	SCOP	4.24	4.10	3.90	4.04	
		Annual energy consumption	kWh	763	1,059	1,378	1,373
	COP	EER	4.53	3.78	3.21	3.02	
		Annual energy consumption	kWh	276	450	780	945
Energy label	Cooling/Heating		A/A		A/B		

Indoor unit		FFQ	25C	35C	50C	60C	
Dimensions	Unit	HeightxWidthxDepth	260x575x575			175	
Weight	Unit		16			17.5	
Decoration panel	Model		BYFQ60CW (white panel) / BYFQ60CS (grey panel) / BYFQ60B3W1 (standard panel)				
	Colour		White (N9.5) / White (N9.5) + Silver / White (RAL9010)				
	Dimensions	HeightxWidthxDepth	46x620x620 / 46x620x620 / 55x700x700				
Weight			2.8 / 2.8 / 2.7				
Air filter	Type		Resin net with mold resistance				
Fan - Air flow rate	Cooling	High/Nom./Low	m ³ /min	9/8/6.5	10/8.5/6.5	12/10/7.5	14.5/12.5/9.5
	Heating	High/Nom./Low	m ³ /min	9/8/6.5	10/8.5/6.5	12/10/7.5	14.5/12.5/9.5
Sound power level	Cooling		dBA	48	51	56	60
Sound pressure level	Cooling	High/Nom./Low	dBA	31/28.5/25	34/30.5/25	39/34/27	43/40/32
	Heating	High/Nom./Low	dBA	31/28.5/25	34/30.5/25	39/34/27	43/40/32
Control systems	Infrared remote control		BRC7F530W (white panel) / BRC7F530S (grey panel) / BRC7EB530 (standard panel)				
	Wired remote control		BRC1D52 / BRC1E52A/B				
Power supply	Phase / Frequency / Voltage	Hz / V	1~ / 50 / 220-240				

Outdoor unit		RXS	25L3	35L3	50L	60L	
Dimensions	Unit	HeightxWidthxDepth	550x765x285		735x825x300		
Weight	Unit		34		47	48	
Sound power level	Cooling		dBA	59	61	62	
	Heating		dBA	59	61	62	
Sound pressure level	Cooling	High/Low/Silent operation	dBA	46/-/43	48/-/44	48/44/-	49/46/-
	Heating	High/Low/Silent operation	dBA	47/-/44	48/-/45	48/45/-	49/46/-
Operation range	Cooling	Ambient	Min.-Max.	-10~46			
	Heating	Ambient	Min.-Max.	-15~-18			
Refrigerant	Type/Charge/GWP	kg/TCO ₂ eq	R-410A/1.0/2.1/2,087.5	R-410A/1.2/2.5/2,087.5	R-410A/1.7/3.5/2,087.5	R-410A/1.5/3.1/2,087.5	
Piping connections	Liquid	OD	6.35				
	Gas	OD	9.5			12.7	
	Piping length	OU - IU	Max.	20			30
		System	Chargeless	10			-
	Additional refrigerant charge		kg/m	0.02 (for piping length exceeding 10m)			
Level difference	IU - OU	Max.	15			20.0	
Power supply	Phase / Frequency / Voltage	Hz / V	1~ / 50 / 220-240		1~ / 50 / 220-230-240		
Current - 50Hz	Maximum fuse amps (MFA)	A	16		20		

(1) EER/COP according to Eurovent 2012, for use outside EU only (2) MFA is used to select the circuit breaker and the ground fault circuit interrupter (earth leakage circuit breaker). For more detailed information on each combination, please refer to the electrical data drawing.

4-way blow ceiling mounted cassette

Solution addressing the primary needs of small shops

- › Ideal solution for busy retail and business environments and small shops
- › Improved energy efficiency: up to A+ energy labels
- › Robust design and body quality
- › Easy installation and maintenance thanks to improved body structure
- › Exclusively offered for pair applications
- › Air can be discharged in any of 4 directions
- › Air filter removes airborne dust particles to ensure a steady supply of clean air
- › Control several indoor units at the same time via the Siesta Sky Air group control (optional)
- › Standard drain pump
- › Fresh air intake integrated in the same system thus reducing installation cost as no additional ventilation is required



Efficiency data			ACQ + AZQS	71D + 71BV1	100D + 100B8V1	125D + 125B8V1	140D + 140B8V1	100D + 100BY1	125D + 125BY1	140D + 140BY1	
Cooling capacity	Nom.		kW	6.8	9.5	12.1	13.0	9.5	12.1	13.0	
Heating capacity	Nom.		kW	7.50	10.80	13.5	15.5	10.8	13.5	15.5	
Power input	Cooling	Nom.	kW	2.05	2.96	3.90	4.05	2.96	3.90	4.05	
	Heating	Nom.	kW	2.08	2.99	3.74	4.29	2.99	3.74	4.29	
Seasonal efficiency (according to EN14825)	Cooling	Energy label		A+	A	-	-	A	-	-	
		Pdesign	kW	6.80	9.50	-	-	9.50	-	-	
		SEER		5.70	5.50	-	-	5.50	-	-	
	Heating (Average climate)	Annual energy consumption	kWh		418	605	-	-	605	-	-
		Energy label			A	-	-	A	-	-	
		Pdesign	kW		6.33	7.60	-	-	7.60	-	-
Nominal efficiency	EER	Annual energy consumption	kWh	4.00	3.85	-	-	3.85	-	-	
		Annual energy consumption	kWh	2,216	2,764	-	-	2,764	-	-	
Nominal efficiency	COP	EER		3.31	3.21	3.10	3.21	3.10	3.21		
		Annual energy consumption	kWh	1,025	1,480	1,952	2,025	1,480	1,952	2,025	
Energy label	Cooling/Heating			A/A	B/A	-	A/A	B/A	-		
Indoor unit			ACQ	71D	100D	125D	140D	100D	125D	140D	
Dimensions	Unit	HeightxWidthxDepth	mm	265x820x820		300x820x820					
Weight	Unit		kg	31	39						
Decoration panel	Colour			White							
	Dimensions	HeightxWidthxDepth	mm	82x990x990							
	Weight		kg	4							
Air filter	Type			Removable / washable							
Fan - Air flow rate	Cooling	High/Nom./Low/Silent operation	m ³ /min	24.4/20.5/17.6/15.0	29.2/24.4/21.0/17.6	34.0/29.2/26.3/22.1	29.2/24.4/21.0/17.6	34.0/29.2/26.3/22.1	34.0/29.2/26.3/22.1		
	Heating	High/Nom./Low/Silent operation	m ³ /min	24.4/20.5/17.6/15.0	29.2/24.4/21.0/17.6	34.0/29.2/26.3/22.1	29.2/24.4/21.0/17.6	34.0/29.2/26.3/22.1	34.0/29.2/26.3/22.1		
Sound power level	Cooling		dBA	54	56	60	56	60			
	Heating		dBA	54	56	60	56	60			
Sound pressure level	Cooling	High/Nom./Low/Silent operation	dBA	41/38/35/32	44/41/38/36	47/44/43/41	44/41/38/36	47/44/43/41			
	Heating	High/Nom./Low/Silent operation	dBA	41/38/35/32	44/41/38/36	47/44/43/41	44/41/38/36	47/44/43/41			
Control systems	Infrared remote control			ARCWLA							
Power supply	Phase / Frequency / Voltage		Hz / V	1~ / 50 / 220-240							
Outdoor unit			AZQS	71BV1	100B8V1	125B8V1	140B8V1	100BY1	125BY1	140BY1	
Dimensions	Unit	HeightxWidthxDepth	mm	770x900x320	990x940x320	1,430x940x320	990x940x320	1,430x940x320			
Weight	Unit		kg	67	72.8	74.3	94.9	82		101	
Sound power level	Cooling		dBA	64	70	71	70	71		70	
Sound pressure level	Cooling	Nom.	dBA	48	53	54	53	54		53	
	Heating	Nom.	dBA	50	57	58	54	57		54	
	Night quiet mode	Level 1	dBA	43			49				
Operation range	Cooling	Ambient	Min.-Max.	-5~46							
	Heating	Ambient	Min.-Max.	-15~-15.5							
Refrigerant	Type/Charge/GWP		kg/TCO ₂ eq	R-410A/2.75/5.7/2,087.5	R-410A/2.9/6.1/2,087.5	R-410A/4.0/8.4/2,087.5	R-410A/2.9/6.1/2,087.5	R-410A/4.0/8.4/2,087.5			
Piping connections	Liquid	OD	mm	9.52							
	Gas	OD	mm	15.9							
	Piping length	OU - IU	Max.	m	50						
		System	Equivalent	m	70						
		Chargeless		m	30						
	Additional refrigerant charge			kg/m	See installation manual						
Level difference	IU - OU	Max.	m	30.0							
	IU - IU	Max.	m	-						0.5	
Power supply	Phase / Frequency / Voltage		Hz / V	1~ / 50 / 220-240			3N~ / 50 / 380-415				
Current - 50Hz	Maximum fuse amps (MFA)		A	20	32	40	16	20	25		

(1) EER/COP according to Eurovent 2012, for use outside EU only (2) MFA is used to select the circuit breaker and the ground fault circuit interrupter (earth leakage circuit breaker). For more detailed information on each combination, please refer to the electrical data drawing.

Small concealed ceiling unit

Designed for hotel applications

- > Compact unit (230mm high & 652mm deep), can easily be mounted in narrow ceiling voids
- > Discretely concealed in the ceiling: only the suction and discharge grilles are visible
- > Whisper quiet operation: down to 28dBA sound pressure level
- > Flexible installation, as the air suction direction can be altered from rear to bottom suction

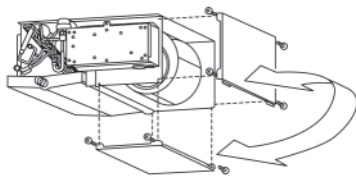

- > For easy mounting, the drain pan can be located to the left or right of the unit

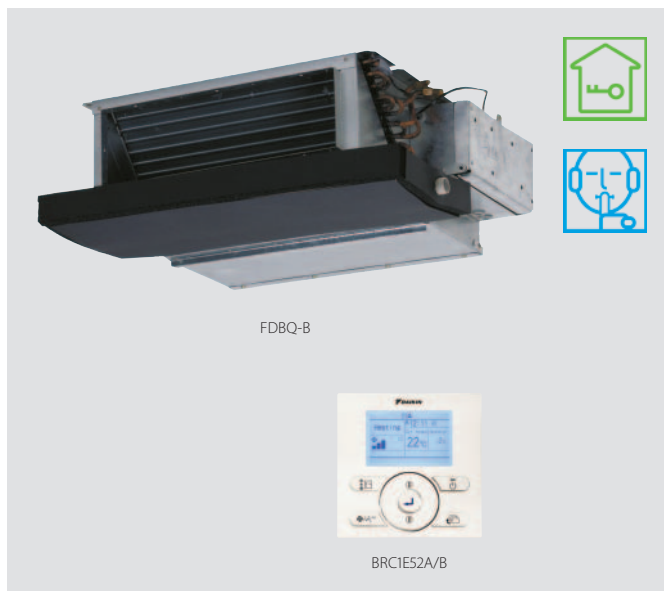

Indoor unit			FDBQ	25B
Dimensions	Unit	HeightxWidthxDepth	mm	230x652x502
Weight	Unit		kg	17.0
Air filter	Type			Resin net with mold resistance
Fan - Air flow rate	Cooling	High/Low	m ³ /min	6.50/5.20
	Heating	High/Low	m ³ /min	6.95/5.20
Sound power level	Cooling		dBA	55
	Heating		dBA	55
Sound pressure level	Cooling	High/Low	dBA	35.0/28.0
	Heating	High/Low	dBA	35.0/29.0
Control systems	Wired remote control			BRC1D52 / BRC1E52A/B
Power supply	Phase / Frequency / Voltage		Hz / V	1~ / 50 / 230

Outdoor unit			5MXS90E	
Dimensions	Unit	HeightxWidthxDepth	mm	
Weight	Unit		kg	
Sound power level	Cooling		dBA	
Sound pressure level	Cooling	Nom.	dBA	
	Heating	Nom.	dBA	
Operation range	Cooling	Ambient	Min.-Max.	°CDB
	Heating	Ambient	Min.-Max.	°CWB
Refrigerant	Type/Charge/GWP		kg/TCO ₂ eq	
Piping connections	Liquid	OD	mm	
	Gas	OD	mm	
	Piping length	OU - IU	Max.	m
	Additional refrigerant charge		kg/m	
Level difference	IU - OU	Max.	m	
	IU - IU	Max.	m	
Power supply	Phase / Frequency / Voltage		Hz / V	
Current - 50Hz	Maximum fuse amps (MFA)		A	

only available in multi model application

(1) MFA is used to select the circuit breaker and the ground fault circuit interrupter (earth leakage circuit breaker). For more detailed information on each combination, please refer to the electrical data drawing.

Concealed ceiling unit

Compact concealed ceiling unit, with a height of only 200mm

- Compact dimensions, can easily be mounted in a ceiling void of only 240mm

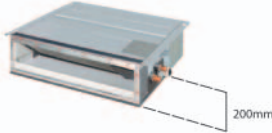

- Medium external static pressure up to 40Pa facilitates unit use with flexible ducts of varying lengths
- Discretely concealed in the ceiling: only the suction and discharge grilles are visible
- Low energy consumption thanks to DC fan motor
- Optimised heating solution for your home

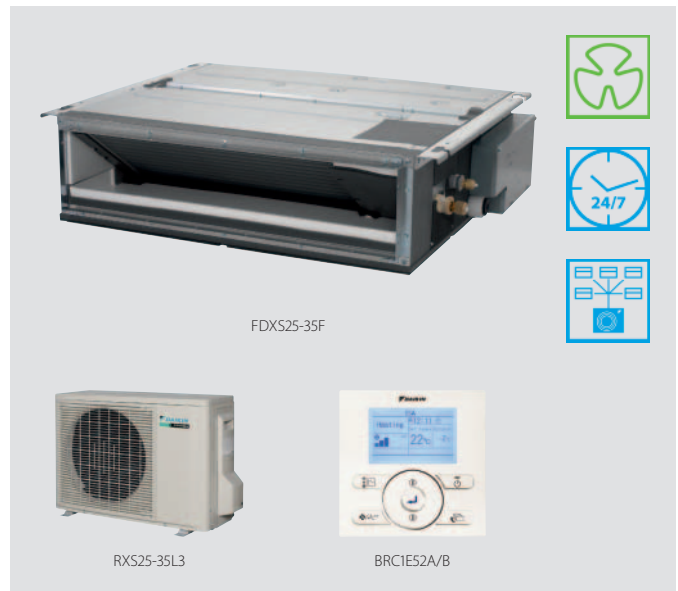

Efficiency data			FDXS + RXS	25F + 25L3	35F + 35L3	50F9 + 50L	60F + 60L
Cooling capacity	Min./Nom./Max.		kW	1.3/2.4/3.0	1.4/3.4/3.8	1.7/5.0/5.3	1.7/6.0/6.5
Heating capacity	Min./Nom./Max.		kW	1.3/3.2/4.5	1.4/4.0/5.0	1.7/5.8/6.0	1.7/7.0/8.0
Power input	Cooling	Nom.	kW	0.641	1.148	1.650	2.060
	Heating	Nom.	kW	0.800	1.150	1.870	2.180
Seasonal efficiency (according to EN14825)	Cooling	Energy label		A+	A	A+	A
		Pdesign	kW	2.40	3.40	5.00	6.00
		SEER		5.63	5.21	5.72	5.51
	Heating (Average climate)	Annual energy consumption	kWh	149	228	306	381
		Energy label		A+		A	
		Pdesign	kW	2.60	2.90	4.00	4.60
Nominal efficiency	EER	SCOP		4.24	3.88	3.93	3.80
		Annual energy consumption	kWh	858	1,047	1,425	1,693
	COP			3.74	2.96	3.03	2.91
		Annual energy consumption	kWh	321	574	825	1,030
Energy label	Cooling/Heating		A/A	B/A	B/D	C/C	

Indoor unit			FDXS	25F	35F	50F9	60F
Dimensions	Unit	HeightxWidthxDepth	mm	200x750x620		200x1,150x620	
Weight	Unit		kg	21		30	
Air filter	Type			Removable / washable / mildew proof			
Fan - Air flow rate	Cooling	High/Nom./Low	m ³ /min	8.7/8.7/7.3		12.0/11.0/10.0	
	Heating	High/Nom./Low	m ³ /min	8.7/8.0/7.3		16.0/14.8/13.5	
Fan - External static pressure	Nom.		Pa	30		40	
Sound power level	Cooling		dBA	53		55	56
	Heating		dBA	53		55	56
Sound pressure level	Cooling	High/Nom./Low	dBA	35/33/27		38/36/30	
	Heating	High/Nom./Low	dBA	35/33/27		38/36/30	
Control systems	Wired remote control			BRC1E52A/B			
Power supply	Phase / Frequency / Voltage		Hz / V	1~ / 50 / 230		1~ / 50 / 220-240	

Outdoor unit			RXS	25L3	35L3	50L	60L	
Dimensions	Unit	HeightxWidthxDepth	mm	550x765x285		735x825x300		
Weight	Unit		kg	34		47	48	
Sound power level	Cooling		dBA	59	61	62		
	Heating		dBA	59	61	62		
Sound pressure level	Cooling	High/Low/Silent operation	dBA	46/-/43	48/-/44	48/44	49/46/-	
	Heating	High/Low/Silent operation	dBA	47/-/44	48/-/45	48/45	49/46/-	
Operation range	Cooling	Ambient	Min.-Max. °CDB	-10~46				
	Heating	Ambient	Min.-Max. °CWB	-15~18				
Refrigerant	Type/Charge/GWP		kg/TCO ₂ eq	R-410A/1.0/2.1/2,0875	R-410A/1.2/2.5/2,0875	R-410A/1.7/3.5/2,0875	R-410A/1.5/3.1/2,0875	
Piping connections	Liquid	OD	mm	6.35				
	Gas	OD	mm	9.5	12.7			
	Piping length	OU - IU	Max.	m	20			
		System	Chargeless	m	10			
	Additional refrigerant charge		kg/m	0.02 (for piping length exceeding 10m)				
Level difference	IU - OU	Max.	m	15		20.0		
Power supply	Phase / Frequency / Voltage		Hz / V	1~ / 50 / 220-240		1~ / 50 / 220-230-240		
Current - 50Hz	Maximum fuse amps (MFA)		A	16		20		

(1) EER/COP according to Eurovent 2012, for use outside EU only (2) MFA is used to select the circuit breaker and the ground fault circuit interrupter (earth leakage circuit breaker). For more detailed information on each combination, please refer to the electrical data drawing.

Concealed ceiling unit with medium ESP

Slimmest yet most powerful medium static pressure unit on the market

- Combination with split outdoor units is ideal for small retail, offices or residential applications
- > Top efficiency in the market! Energy label up to A++
- > Slimmest unit in class, only 245mm (300mm built-in height) and therefore narrow ceiling voids are no longer a challenge
- > Lowest sound levels in the market: down to 25dBA!
- > Medium external static pressure up to 150Pa facilitates using flexible ducts of varying lengths
- > Possibility to change ESP via wired remote control allows optimisation of the supply air volume
- > Discretely concealed in the ceiling: only the suction and discharge grilles are visible
- > Fresh air intake integrated in the same system thus reducing installation cost as no additional ventilation is required



* Brings in up to 10% of fresh air into the room
 * Allows larger quantities of fresh air to be bought in
 * Distributes fresh air so it is most effectively pre-cooled / pre-heated

- > Reduced energy consumption thanks to specially developed DC fan motor and drain pump
- > No optional adapter needed for DIII-connection, link your unit into the wider building management system.



- > Flexible installation: air suction direction can be altered from rear to bottom suction and choice between free use or connection to optional suction grilles



- > Standard built-in drain pump with 625mm lift increases increases flexibility and installation speed

Efficiency data		FBQ + RXS	35D + 35L3	50D + 50L	60D + 60L	
Cooling capacity	Nom.	kW	3.4	5.0	5.7	
Heating capacity	Nom.	kW	4.00	5.50	7.00	
Power input	Cooling	Nom. kW	0.85	1.42	1.65	
	Heating	Nom. kW	1.00	1.44	1.89	
Seasonal efficiency (according to EN14825)	Cooling	Energy label	A++			
		Pdesign	kW	3.40	5.00	5.70
	SEER		6.17	6.21	5.86	
	Annual energy consumption	kWh	193	282	340	
	Heating (Average climate)	Energy label	A+			
Pdesign		kW	2.90	4.40	4.60	
SCOP			4.07	4.06	4.01	
Nominal efficiency	EER	Annual energy consumption	kWh	998	1,517	1,606
		COP		3.99	3.52	3.45
	COP	Annual energy consumption	kWh	4.02	3.83	3.71
		Energy label	Cooling/Heating	A/A		

Indoor unit		FBQ	35D	50D	60D
Dimensions	Unit	HeightxWidthxDepth	245x700x800		245x1,000x800
Weight	Unit		28		35
Air filter	Type		Resin net with mold resistance		
Fan - Air flow rate	Cooling	High/Nom./Low	15/12.5/10.5		18/15/12.5
	Heating	High/Nom./Low	15/12.5/10.5		18/15/12.5
Fan - External static pressure	High/Nom.		150/30		
Sound power level	Cooling		60		56
Sound pressure level	Cooling	High/Nom./Low	35/32/29		30/28/25
	Heating	High/Nom./Low	37/34/29		31/28/25
Control systems	Infrared remote control		BRC4C65		
	Wired remote control		BRC1E52A/B / BRC1D52		
Power supply	Phase / Frequency / Voltage	Hz / V	1~ / 50 / 220-240		

Outdoor unit		RXS	35L3	50L	60L	
Dimensions	Unit	HeightxWidthxDepth	550x765x285	735x825x300		
Weight	Unit		34	47	48	
Sound power level	Cooling		61	62		
	Heating		61	62		
Sound pressure level	Cooling	High/Low/Silent operation	48/-/44	48/44/-	49/46/-	
	Heating	High/Low/Silent operation	48/-/45	48/45/-	49/46/-	
Operation range	Cooling	Ambient Min.-Max.	°CDB -10~-46			
	Heating	Ambient Min.-Max.	°CWB -15~-18			
Refrigerant	Type/Charge/GWP	kg/TCO ₂ eq	R-410A/1.2/2.5/2,087.5	R-410A/1.7/3.5/2,087.5		
Piping connections	Liquid	OD	6.35			
	Gas	OD	9.5	12.7		
	Piping length	OU - IU	Max.	20	30	
		System	Chargeless	10	-	
	Additional refrigerant charge		kg/m	0.02 (for piping length exceeding 10m)		
Level difference	IU - OU	Max.	15	20.0		
Power supply	Phase / Frequency / Voltage	Hz / V	1~ / 50 / 220-240		1~ / 50 / 220-230-240	
Current - 50Hz	Maximum fuse amps (MFA)	A	16		20	

(1) EER/COP according to Eurovent 2012, for use outside EU only (2) MFA is used to select the circuit breaker and the ground fault circuit interrupter (earth leakage circuit breaker). For more detailed information on each combination, please refer to the electrical data drawing.

Concealed ceiling unit with medium ESP

Slimmest yet most powerful medium static pressure unit on the market

Combination with Seasonal Classic ensures good value for money for all types of commercial applications

- > Top efficiency in the market! Energy label up to A++
- > Slimmest unit in class, only 245mm (300mm built-in height) and therefore narrow ceiling voids are no longer a challenge
- > Lowest sound levels in the market: down to 25dBA!
- > Medium external static pressure up to 150Pa facilitates using flexible ducts of varying lengths
- > Possibility to change ESP via wired remote control allows optimisation of the supply air volume
- > Discretely concealed in the ceiling: only the suction and discharge grilles are visible
- > Fresh air intake integrated in the same system thus reducing installation cost as no additional ventilation is required
 - Fresh air intake opening in casing
 - Optional fresh air intake kit
- > Reduced energy consumption thanks to specially developed DC fan motor and drain pump
- > No optional adapter needed for DIII-connection, link your unit into the wider building management system.

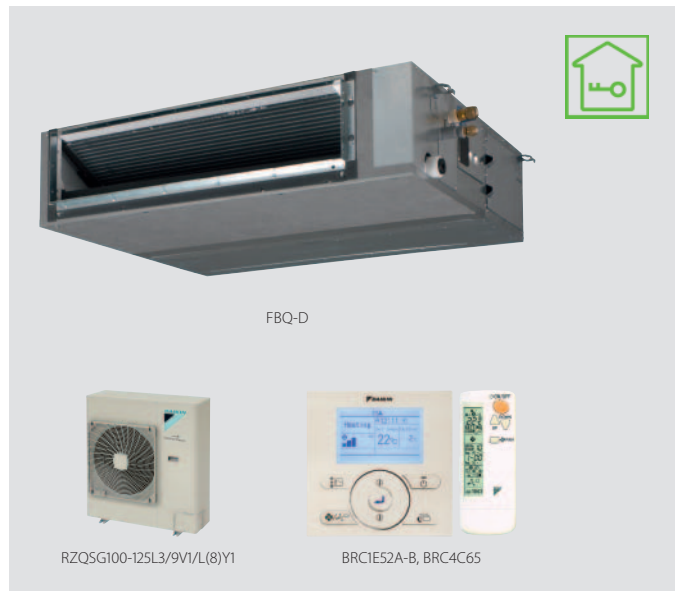
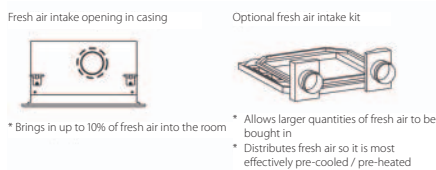

- > Flexible installation: air suction direction can be altered from rear to bottom suction and choice between free use or connection to optional suction grilles



- > Standard built-in drain pump with 625mm lift increases increases flexibility and installation speed

Efficiency data		FBQ + RZQSG	71D + 71L3V1	100D + 100L9V1	125D + 125L9V1	140D + 140L9V1	100D + 100L8Y1	125D + 125L8Y1	140D + 140LY1	
Cooling capacity	Nom.	kW	6.8	9.5	12.0	13.4	9.5	12.0	13.4	
Heating capacity	Nom.	kW	7.50	10.80	13.50	15.50	10.80	13.50	15.50	
Power input	Cooling	Nom.	1.98	2.84	3.72	4.38	2.84	3.72	4.38	
	Heating	Nom.	1.91	2.94	3.72	4.56	2.94	3.72	4.56	
Seasonal efficiency (according to EN14825)	Cooling	Energy label	A+		A	-	A+	A	-	
		Pdesign	kW	6.80	9.50	12.00	-	9.50	12.00	-
		SEER		5.84	5.61	5.47	-	5.61	5.47	-
	Heating (Average climate)	Annual energy consumption	kWh	408	593	768	-	593	768	-
		Energy label	A+		-	-	A+	-	-	
		Pdesign	kW	6.00	7.60	-	-	7.60	-	-
Nominal efficiency	EER		3.43	3.35	3.23	3.06	3.35	3.23	3.06	
	COP		3.92	3.67	3.63	3.40	3.67	3.63	3.40	
	Annual energy consumption	kWh	991	1,418	1,858	-	1,418	1,858	-	
	Energy label	Cooling/Heating	A/A		-	-	A/A	-	-	

Indoor unit		FBQ	71D	100D	125D	140D	100D	125D	140D
Dimensions	Unit	HeightxWidthxDepth	mm	245x1,000x800	245x1,400x800				
Weight	Unit		kg	35	46				
Air filter	Type			Resin net with mold resistance					
Fan - Air flow rate	Cooling	High/Nom./Low	m³/min	18/15/12.5	29/26/23	34/29/23.5		29/26/23	34/29/23.5
	Heating	High/Nom./Low	m³/min	18/15/12.5	29/26/23	34/29/23.5		29/26/23	34/29/23.5
Fan - External static pressure	High/Nom.		Pa	150/30	150/40	150/50		150/40	150/50
Sound power level	Cooling		dBA	56	58	62		58	62
	Heating	High/Nom./Low	dBA	30/28/25	34/32/30	37/35/32		34/32/30	37/35/32
Control systems	Infrared remote control			BRC4C65					
	Wired remote control			BRC1E52A/B / BRC1D52					
Power supply	Phase / Frequency / Voltage		Hz / V	1~ / 50 / 220-240					

Outdoor unit		RZQSG	71L3V1	100L9V1	125L9V1	140L9V1	100L8Y1	125L8Y1	140LY1
Dimensions	Unit	HeightxWidthxDepth	mm	770x900x320	990x940x320	1,430x940x320	990x940x320	1,430x940x320	1,430x940x320
Weight	Unit		kg	67	72	74	95	82	101
Sound power level	Cooling		dBA	65	70		69	70	69
	Heating	Nom./Silent operation	dBA	49/47	53/-	54/-	53/-	54/-	53/-
Sound pressure level	Heating	Nom.	dBA	51	57	58	54	57	54
	Night quiet mode	Level 1	dBA	-	49				
Operation range	Cooling	Ambient	Min.-Max.	-15~46					
	Heating	Ambient	Min.-Max.	-15~-15.5					
Refrigerant	Type/Charge/GWP		kg/TCO ₂ eq	R-410A/2.75/5.7/2,087.5	R-410A/2.9/6.1/2,087.5	R-410A/4.0/8.4/2,087.5	R-410A/2.9/6.1/2,087.5	R-410A/4.0/8.4/2,087.5	
Piping connections	Liquid	OD	mm	9.52					
	Gas	OD	mm	15.9					
	Piping length	OU - IU	Max.	m	50				
		System	Equivalent	m	70				
Additional refrigerant charge	Chargeless		m	30					
	Level difference	IU - OU	Max.	m					
		IU - IU	Max.	m					
Power supply	Phase / Frequency / Voltage		Hz / V	1~ / 50 / 220-240				3N~ / 50 / 380-415	
Current - 50Hz	Maximum fuse amps (MFA)		A	25	40		20	25	

(1) EER/COP according to Eurovent 2012, for use outside EU only (2) MFA is used to select the circuit breaker and the ground fault circuit interrupter (earth leakage circuit breaker). For more detailed information on each combination, please refer to the electrical data drawing.

Combination with Seasonal Smart ensures best in class quality, highest efficiency and performance

Automatic Airflow Adjustment function

Automatically selects the most appropriate fan curve to achieve the units' nominal air flow within ±10%

Why?

After installation the real ducting will frequently differ from the initially calculated air flow resistance → the real air flow may be much lower or higher than nominal, leading to a lack of capacity or uncomfortable air temperature

Automatic Airflow Adjustment function will adapt the unit's fan speed to any ducting automatically (10 or more fan curves are available on every model), making installation much faster

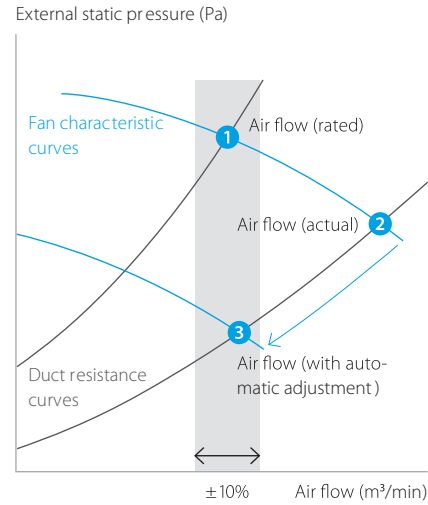

Efficiency data		FBQ + RZQG	71D + 71L9V1	100D + 100L9V1	125D + 125L9V1	140D + 140L9V1	71D + 71L8Y1	100D + 100L8Y1	125D + 125L8Y1	140D + 140LY1	
Cooling capacity	Nom.	kW	6.8	9.5	12.0	13.4	6.8	9.5	12.0	13.4	
Heating capacity	Nom.	kW	7.50	10.80	13.50	15.50	7.50	10.80	13.50	15.50	
Power input	Cooling	Nom.	kW	1.89	2.49	3.63	4.00	1.89	2.49	3.63	4.00
	Heating	Nom.	kW	1.87	2.45	3.46	4.31	1.87	2.45	3.46	4.31
Seasonal efficiency (according to EN14825)	Cooling	Energy label		A++	A+	A++	-	A++	A+	A++	-
		Pdesign	kW	6.80	9.50	12.00	-	6.80	9.50	12.00	-
		SEER		6.16	5.87	6.11	-	6.16	5.87	6.11	-
		Annual energy consumption	kWh	386	566	687	-	386	566	687	-
	Heating (Average climate)	Energy label		A+	A++	A+	-	A+	A++	A+	-
		Pdesign	kW	6.00	11.30	12.70	-	6.00	11.30	12.70	-
		SCOP		4.31	4.78	4.28	-	4.31	4.78	4.28	-
		Annual energy consumption	kWh	1,949	3,310	4,154	-	1,949	3,310	4,154	-
Nominal efficiency	EER		3.60	3.81	3.31	3.35	3.60	3.81	3.31	3.35	
	COP		4.01	4.41	3.90	3.60	4.01	4.41	3.90	3.60	
	Annual energy consumption	kWh	944	1,247	1,813	-	944	1,247	1,813	-	
	Energy label	Cooling/Heating		A/A		-		A/A		-	
Indoor unit		FBQ	71D	100D	125D	140D	71D	100D	125D	140D	
Dimensions	Unit	HeightxWidthxDepth	mm	245x1,000x800			245x1,000x800			245x1,400x800	
Weight	Unit		kg	35	46			35	46		
Air filter	Type			Resin net with mold resistance							
Fan - Air flow rate	Cooling	High/Nom./Low	m³/min	18/15/12.5	29/26/23	34/29/23.5		18/15/12.5	29/26/23	34/29/23.5	
	Heating	High/Nom./Low	m³/min	18/15/12.5	29/26/23	34/29/23.5		18/15/12.5	29/26/23	34/29/23.5	
Fan - External static pressure	High/Nom.		Pa	150/30	150/40	150/50		150/30	150/40	150/50	
Sound power level	Cooling		dB(A)	56	58	62		56	58	62	
Sound pressure level	Cooling	High/Nom./Low	dB(A)	30/28/25	34/32/30	37/35/32		30/28/25	34/32/30	37/35/32	
	Heating	High/Nom./Low	dB(A)	31/28/25	36/33/30	38/35/32		31/28/25	36/33/30	38/35/32	
Control systems	Infrared remote control			BRC4C65							
	Wired remote control			BRC1E52A/B / BRC1D528							
Power supply	Phase / Frequency / Voltage	Hz / V		1~ / 50 / 220-240							
Outdoor unit		RZQG	71L9V1	100L9V1	125L9V1	140L9V1	71L8Y1	100L8Y1	125L8Y1	140LY1	
Dimensions	Unit	HeightxWidthxDepth	mm	990x940x320		1,430x940x320		990x940x320		1,430x940x320	
Weight	Unit		kg	69	95			80	101		
Sound power level	Cooling		dB(A)	64	66	67	69	64	66	67	
Sound pressure level	Cooling	Nom.	dB(A)	48	50	51	52	48	50	51	
	Heating	Nom.	dB(A)	50	52	53		50	52	53	
Night quiet mode	Level 1		dB(A)	43	45			43	45		
Operation range	Cooling	Ambient	Min.-Max.	-15~-50							
	Heating	Ambient	Min.-Max.	-20~-15.5							
Refrigerant	Type/Charge/GWP	kg/TCO ₂ eq		R-410A/2.9/612,0875			R-410A/4.0/8.4/2,087.5		R-410A/2.9/612,0875		
Piping connections	Liquid	OD	mm	9.52							
	Gas	OD	mm	15.9							
	Piping length	OU - IU	Max.	m	50	75			50	75	
		System	Equivalent	m	70	90			70	90	
		Chargeless		m	30						
	Additional refrigerant charge		kg/m	See installation manual							
Level difference	IU - OU	Max.	m	30.0							
	IU - IU	Max.	m	0.5							
Power supply	Phase / Frequency / Voltage	Hz / V		1~ / 50 / 220-240			3N~ / 50 / 380-415				
Current - 50Hz	Maximum fuse amps (MFA)	A	20	32		40	16	20	25		

(1) EER/COP according to Eurovent 2012, for use outside EU only (2) MFA is used to select the circuit breaker and the ground fault circuit interrupter (earth leakage circuit breaker). For more detailed information on each combination, please refer to the electrical data drawing.

Concealed ceiling unit with high ESP

ESP up to 200, ideal for large sized spaces

- › Seasonal Smart ensures the best in quality, highest efficiency and performance. Seasonal Classic gives value for money.
- › Automatic air flow adjustment function measures the air volume and static pressure and adjusts it towards the nominal air flow, whatever the length of duct, making installation easier and guaranteeing comfort. Moreover, the ESP can be changed via the wired remote control to optimize the supply air volume
- › High external static pressure up to 200Pa facilitates using flexible ducts of varying lengths
- › Discretely concealed in the ceiling: only the suction and discharge grilles are visible
- › Reduced energy consumption thanks to specially developed DC fan motor
- › Possibility to change ESP via wired remote control allows optimisation of the supply air volume
- › Flexible installation, as the air suction direction can be altered from rear to bottom suction
- › Standard built-in drain pump increases flexibility and installation speed
- › No optional adapter needed for DIII-connection, link your unit into the wider building management system.

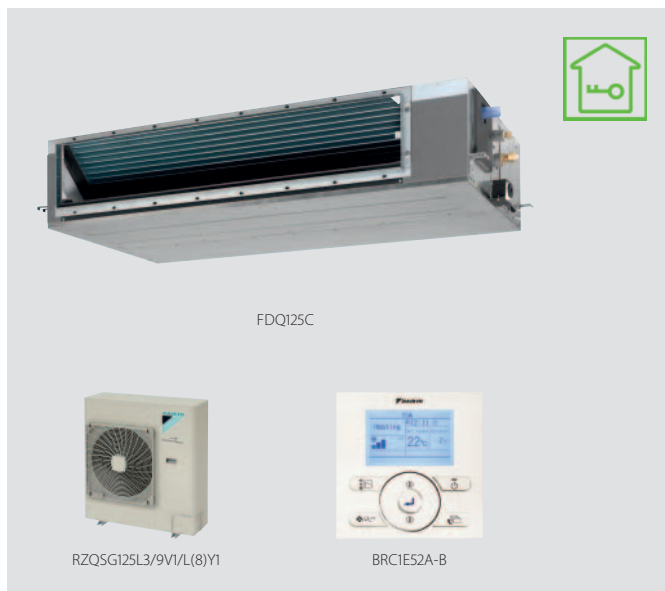

Efficiency data			FDQ + RZQG/RZQSG		Seasonal Smart		Seasonal Classic	
					125C + 125L9V1	125C + 125L8Y1	125C + 125L9V1	125C + 125L8Y1
Cooling capacity	Nom.	kW		12.0		12.0		
Heating capacity	Nom.	kW		13.5		13.5		
Power input	Cooling	Nom.	kW	3.20		3.74		
	Heating	Nom.	kW	3.53		3.85		
Seasonal efficiency (according to EN14825)	Cooling	Energy label		A+		A		
		Pdesign	kW	12.00		12.00		
		SEER		5.81		5.20		
	Heating (Average climate)	Annual energy consumption	kWh		723		808	
		Energy label			A+		A	
		Pdesign	kW		12.71		7.60	
Nominal efficiency	EER	SCOP		4.21		3.90		
		Annual energy consumption	kWh		4,227		2,729	
	COP				3.75		3.21	
		Annual energy consumption	kWh		1,600		1,870	
Energy label	Cooling/Heating			A/A		A/B		

Indoor unit				FDQ	125C	
Dimensions	Unit	HeightxWidthxDpeth	mm		300x1,400x700	
Required ceiling void	>		mm		350	
Weight	Unit		kg		45	
Decoration panel	Model				BYBS125DJW1	
	Colour				White (10Y9/0.5)	
	Dimensions	HeightxWidthxDpeth	mm		55x1,500x500	
	Weight		kg		6.5	
Air filter	Type				Resin net with mold resistance	
Fan - Air flow rate	Cooling	High/Low	m ³ /min		39/28	
	Heating	High/Low	m ³ /min		39/28	
Fan - External static pressure	High/Nom.		Pa		200/50	
Sound power level	Cooling		dBA		66	
Sound pressure level	Cooling	High/Low	dBA		40/33	
	Heating	High/Low	dBA		40/33	
Control systems	Infrared remote control				BRC4C65	
	Wired remote control				BRC1D52 / BRC1E52A/B	
Power supply	Phase / Frequency / Voltage		Hz / V		1~ / 50/60 / 220-240/220	

Outdoor unit				RZQG/RZQSG	125L9V1	125L8Y1	125L9V1	125L8Y1
Dimensions	Unit	HeightxWidthxDpeth	mm		1,430x940x320		990x940x320	
Weight	Unit		kg		95	101	74	82
Sound power level	Cooling		dBA			67		70
Sound pressure level	Cooling	Nom.	dBA			51		54
	Heating	Nom.	dBA			53		58
Operation range	Night quiet mode	Level 1	dBA			45		49
	Cooling	Ambient	Min.-Max.	°CDB		-15~50		-15~46
	Heating	Ambient	Min.-Max.	°CWB		-20~15.5		-15~15.5
Refrigerant	Type/Charge/GWP		kg/TCO ₂ eq		R-410A/4.0/8.4/2,087.5		R-410A/2.9/6.1/2,087.5	
Piping connections	Liquid	OD	mm				9.52	
	Gas	OD	mm				15.9	
Piping length	OU - IU	Max.	m			75		50
	System	Equivalent	m			90		70
	Chargeless		m				30	
Additional refrigerant charge			kg/m				See installation manual	
Level difference	IU - OU	Max.	m				30.0	
	IU - IU	Max.	m				0.5	
Power supply	Phase / Frequency / Voltage		Hz / V		1~ / 50 / 220-240	3N~ / 50 / 380-415	1~ / 50 / 220-240	3N~ / 50 / 380-415
Current - 50Hz	Maximum fuse amps (MFA)		A		-	25	-	20

(1) EER/COP according to Eurovent 2012, for use outside EU only (2) MFA is used to select the circuit breaker and the ground fault circuit interrupter (earth leakage circuit breaker). For more detailed information on each combination, please refer to the electrical data drawing.



Concealed ceiling unit with high ESP

ESP up to 250, ideal for extra large sized spaces

- › High external static pressure up to 250Pa facilitates using flexible ducts of varying lengths
- › Discretely concealed in the ceiling: only the suction and discharge grilles are visible
- › Up to 26.4kW in heating mode

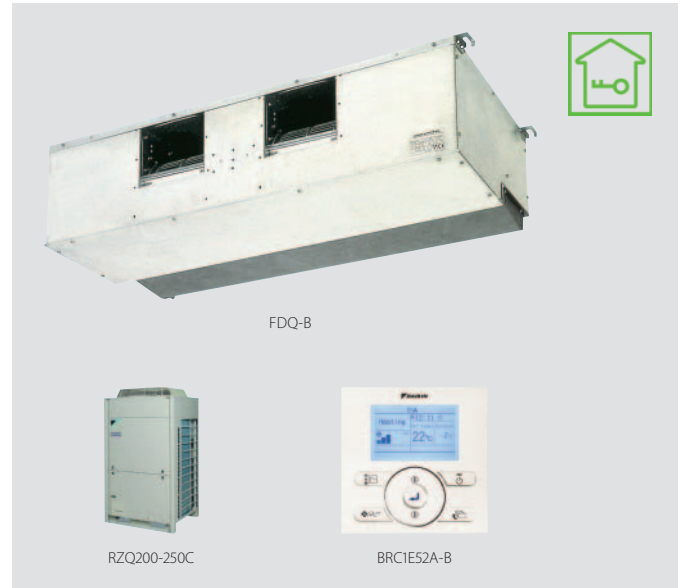

Efficiency data		FDQ + RZQ		200B + 200C		250B + 250C	
Cooling capacity	Nom.	kW		20.0		24.1	
Heating capacity	Nom.	kW		23.0		26.4	
Power input	Cooling	Nom.	kW	6.23		8.58	
	Heating	Nom.	kW	6.74		8.22	
Nominal efficiency (cooling at 35°/27°)	EER			3.21		2.81	
	COP			3.41		3.21	
nominal load, heating at 7°/20° nominal load)	Annual energy consumption		kWh	3,115		4,290	
	Energy label	Cooling/Heating					

Indoor unit		FDQ		200B		250B		
Dimensions	Unit	HeightxWidthxDepth		mm		450x1,400x900		
Required ceiling void >		mm		450				
Weight	Unit	kg		89.0		94.0		
Air filter	Type			Resin net with mold resistance				
Fan - Air flow rate	Cooling	Nom.	m ³ /min	69.0		89.0		
	Heating	Nom.	m ³ /min	69.0		89.0		
Fan - External static pressure	High/Nom./Low	Pa		250/250/250				
Sound power level	Cooling	dBA		81		82		
Sound pressure level	Cooling	High	dBA	45.0		47.0		
	Heating	Low	dBA	45.0		47.0		
Control systems	Wired remote control				BRC1D52 / BRC1E52A/B			
Power supply	Phase / Frequency / Voltage		Hz / V		1~ / 50 / 230			

Outdoor unit		RZQ		200C		250C		
Dimensions	Unit	HeightxWidthxDepth		mm		1,680x930x765		
Weight	Unit	kg		183		184		
Sound power level	Cooling	dBA		78				
	Heating	dBA		78				
Sound pressure level	Nom.	dBA		57				
Operation range	Cooling	Ambient	Min.-Max.	°CDB		-5.0~46.0		
	Heating	Ambient	Min.-Max.	°CWB		-15.0~15.0		
Refrigerant	Type/Charge/GWP	kg/TCO ₂ eq		R-410A/8.3/17.3/2,087.5		R-410A/9.3/19.4/2,087.5		
Piping connections	Liquid	OD	mm	9.52		12.7		
	Gas	OD	mm			22.2		
Piping length	OU - IU	Max.	m			100		
Level difference	IU - OU	Max.	m			-		
Power supply	Phase / Frequency / Voltage		Hz / V		3N~ / 50 / 380-415			
Current - 50Hz	Maximum fuse amps (MFA)		A		20			

(1) MFA is used to select the circuit breaker and the ground fault circuit interrupter (earth leakage circuit breaker). For more detailed information on each combination, please refer to the electrical data drawing.

Concealed ceiling unit

Ideal for medium sized shops with false ceilings

- › Ideal solution for busy retail and business environments and small shops
- › Discretely concealed in the ceiling: only the suction and discharge grilles are visible
- › Exclusively offered for pair applications
- › Air filter removes airborne dust particles to ensure a steady supply of clean air
- › Easy installation and maintenance
- › Double protection drainage system ensures quality



Efficiency data		ABQ + AZQS	71C + 71BV1	100C + 100B8V1	125C + 125B8V1	140C + 140B8V1	100C + 100BY1	125C + 125BY1	140C + 140BY1		
Cooling capacity	Nom.	kW	6.8	9.5	12.1	13.0	9.5	12.1	13.0		
Heating capacity	Nom.	kW	7.5	10.8	13.5	15.5	10.8	13.5	15.5		
Power input	Cooling	Nom.	2.33	3.63	4.31	4.32	3.63	4.31	4.32		
	Heating	Nom.	2.13	3.16	3.96	4.55	3.16	3.96	4.55		
Seasonal efficiency (according to EN14825)	Cooling	Energy label	B		-		B		-		
		Pdesign	kW	6.80	9.50	-		9.50	-		
		SEER	4.65		-		4.65		-		
	Heating (Average climate)	Annual energy consumption	kWh	512	716	-		716	-		
		Energy label	A		-		A		-		
		Pdesign	kW	5.65	6.78	-		6.78	-		
Nominal efficiency	EER	COP	3.80		-		3.80		-		
			Annual energy consumption	kWh	2,082	2,498	-		2,498	-	
Nominal efficiency	EER	COP	2.91	2.62	2.81	3.01	2.62	2.81	3.01		
			3.51	3.42	3.41		3.42	3.41			
			Annual energy consumption	kWh	1,165	1,813	2,153	-	1,813	2,153	-
			Energy label	Cooling/Heating	C/B	D/B	C/B	-	D/B	C/B	-

Indoor unit		ABQ	71C	100C	125C	140C	100C	125C	140C	
Dimensions	Unit	HeightxWidthxDepth	mm	285x600x1,007	378x541x1,045	378x541x1,299	378x541x1,499	378x541x1,045	378x541x1,299	378x541x1,499
Weight	Unit		kg	35	44	50	56	44	50	56
Air filter	Type			Saranet						
Fan - Air flow rate	Cooling	High/Nom./Low	m³/min	18.3/16.8/15.4	22.7/20.5/18.3	40.5/37.4/34.8	48.7/43.9/37.9	22.7/20.5/18.3	40.5/37.4/34.8	48.7/43.9/37.9
	Heating	High/Nom./Low	m³/min	18.3/16.8/15.4	22.7/20.5/18.3	40.5/37.4/34.8	48.7/43.9/37.9	22.7/20.5/18.3	40.5/37.4/34.8	48.7/43.9/37.9
Fan - External static pressure	High/Nom./Low		Pa	90/77/64	70/57/45	150/128/111	150/122/92	70/57/45	150/128/111	150/122/92
Sound power level	Cooling		dB(A)	64	60	-		60	-	
	Heating		dB(A)	64	60	-		60	-	
Sound pressure level	Cooling	High/Nom./Low	dB(A)	-	41/38/36	53/52/50	55/53/50	41/38/36	53/52/50	55/53/50
	Heating	High/Nom./Low	dB(A)	-	41/38/36	53/52/50	55/53/50	41/38/36	53/52/50	55/53/50
Control systems	Wired remote control			ARCWB						
Power supply	Phase / Frequency / Voltage		Hz / V	1~ / 50 / 220-240						

Outdoor unit		AZQS	71BV1	100B8V1	125B8V1	140B8V1	100BY1	125BY1	140BY1
Dimensions	Unit	HeightxWidthxDepth	mm	770x900x320	990x940x320	1,430x940x320	990x940x320	1,430x940x320	1,430x940x320
Weight	Unit		kg	67	72.8	74.3	94.9	82	101
Sound power level	Cooling		dB(A)	64	70	71	70	71	70
Sound pressure level	Cooling	Nom.	dB(A)	48	53	54	53	54	53
	Heating	Nom.	dB(A)	50	57	58	54	57	54
Operation range	Night quiet mode	Level 1	dB(A)	43	49				
	Cooling	Ambient	Min.-Max.	°CDB		-5~46			
Refrigerant	Heating	Ambient	Min.-Max.	°CWB		-15~-15.5			
	Type/Charge/GWP		kg/TCO ₂ eq	R-410A/2.75/5.7/2,087.5	R-410A/2.9/6.1/2,087.5	R-410A/4.0/8.4/2,087.5	R-410A/2.9/6.1/2,087.5	R-410A/4.0/8.4/2,087.5	
Piping connections	Liquid	OD	mm	9.52					
	Gas	OD	mm	15.9					
	Piping length	OU - IU	Max.	m	50				
		System	Equivalent	m	70				
		Chargeless	m	30					
	Additional refrigerant charge		kg/m	See installation manual					
Level difference	IU - OU	Max.	m	30.0					
	IU - IU	Max.	m	-	0.5				
Power supply	Phase / Frequency / Voltage		Hz / V	1~ / 50 / 220-240			3N~ / 50 / 380-415		
Current - 50Hz	Maximum fuse amps (MFA)		A	20	32	40	16	20	25

(1) EER/COP according to Eurovent 2012, for use outside EU only (2) MFA is used to select the circuit breaker and the ground fault circuit interrupter (earth leakage circuit breaker). For more detailed information on each combination, please refer to the electrical data drawing.

Ceiling suspended unit

For wide rooms with no false ceilings nor free floor space

- › Ideal for comfortable air flow in wide rooms thanks to Coanda effect: up to 100° discharge angle
- › Even rooms with ceilings up to 3.8m can be heated up or cooled down very easily without capacity loss
- › Can easily be mounted in corners and narrow spaces, as it only needs 30mm lateral service space

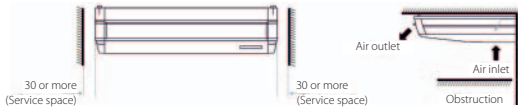
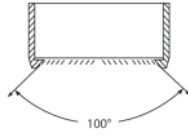

- › Reduced energy consumption thanks to specially developed DC fan motor and drain pump
- › Stylish unit blends easily with any interior. The flaps close entirely when the unit is not operating and there are no air intake grilles visible
- › No optional adapter needed for DIII-connection, link your unit into the wider building management system.
- › Drain pump kit available as accessory



- › Fresh air intake integrated in the same system thus reducing installation cost as no additional ventilation device is required

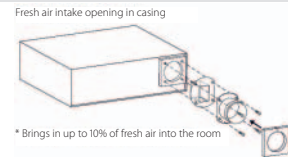

Efficiency data			FHQ + RXS	35C + 35L3	50C + 50L	60C + 60L
Cooling capacity	Min./Nom./Max.		kW	1.4/3.40/4.0	1.7/5.0/5.3	1.7/5.7/5.7
Heating capacity	Min./Nom./Max.		kW	1.3/4.00/5.1	1.7/6.0/6.0	1.7/7.20/7.2
Power input	Cooling	Min./Nom./Max.	kW	0.410/0.950/1.490	-/1.570/-	-/1.750/-
	Heating	Min./Nom./Max.	kW	0.270/0.980/1.980	-/1.790/-	-/2.170/-
Seasonal efficiency (according to EN14825)	Cooling	Energy label		A++		A+
		Pdesign	kW	3.40	5.00	5.70
		SEER		6.18	5.87	6.02
	Heating (Average climate)	Annual energy consumption	kWh	193	298	332
		Energy label		A+		A
		Pdesign	kW	3.10	4.35	4.71
Nominal efficiency	EER	SCOP		4.43	3.86	3.87
		Annual energy consumption	kWh	981	1,578	1,705
	COP	EER		3.58	3.18	3.26
		Annual energy consumption	kWh	475	785	875
Energy label	Cooling/Heating		A/A	B/C	A/C	

Indoor unit			FHQ	35C	50C	60C
Dimensions	Unit	HeightxWidthxDepth	mm	235x960x690		
Weight	Unit		kg	24	25	31
Air filter	Type			Resin net with mold resistance		
Fan - Air flow rate	Cooling	High/Nom./Low	m³/min	14/11.5/10	15/12/10	19.5/15/11.5
	Heating	High/Nom./Low	m³/min	14/11.5/10	15/12/10	19.5/15/11.5
Sound power level	Cooling		dBA	53		54
	Heating		dBA	53		54
Sound pressure level	Cooling	High/Nom./Low	dBA	36/34/31	37/35/32	37/35/33
	Heating	High/Nom./Low	dBA	36/34/31	37/35/32	37/35/33
Control systems	Infrared remote control			BRC7G53		
	Wired remote control			BRC1D52 / BRC1E52A/B		
Power supply	Phase / Frequency / Voltage		Hz / V	1~ / 50/60 / 220-240/220		

Outdoor unit			RXS	35L3	50L	60L	
Dimensions	Unit	HeightxWidthxDepth	mm	550x765x285	735x825x300		
Weight	Unit		kg	34	47	48	
Sound power level	Cooling		dBA	61		62	
	Heating		dBA	61		62	
Sound pressure level	Cooling	High/Low/Silent operation	dBA	48/-/44	48/44/-	49/46/-	
	Heating	High/Low/Silent operation	dBA	48/-/45	48/45/-	49/46/-	
Operation range	Cooling	Ambient	Min.-Max.	°CDB -10~-46			
	Heating	Ambient	Min.-Max.	°CWB -15~-18			
Refrigerant	Type/Charge/GWP		kg/TCO ₂ eq	R-410A/1.2/2.5/2,087.5	R-410A/1.7/3.5/2,087.5	R-410A/1.5/3.1/2,087.5	
Piping connections	Liquid	OD	mm	6.35			
	Gas	OD	mm	9.5		12.7	
	Piping length	OU - IU	Max.	m	20		30
		System	Chargeless	m	10		-
Additional refrigerant charge			kg/m	0.02 (for piping length exceeding 10m)			
Level difference IU - OU			Max.	m 20.0			
Power supply	Phase / Frequency / Voltage		Hz / V	1~ / 50 / 220-240	1~ / 50 / 220-230-240		
Current - 50Hz	Maximum fuse amps (MFA)		A	16	20		

(1) EER/COP according to Eurovent 2012, for use outside EU only (2) MFA is used to select the circuit breaker and the ground fault circuit interrupter (earth leakage circuit breaker). For more detailed information on each combination, please refer to the electrical data drawing.

Ceiling suspended unit

For wide rooms with no false ceilings nor free floor space

Combination with Seasonal Classic ensures good value for money for all types of commercial applications

- › Ideal for comfortable air flow in wide rooms thanks to Coanda effect: up to 100° discharge angle
- › Even rooms with ceilings up to 3.8m can be heated up or cooled down very easily without capacity loss
- › Can easily be mounted in corners and narrow spaces, as it only needs 30mm lateral service space

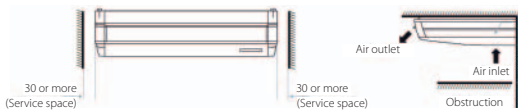
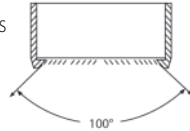

- › Stylish unit blends easily with any interior. The flaps close entirely when the unit is not operating and there are no air intake grilles visible
- › No optional adapter needed for DIII-connection, link your unit into the wider building management system.
- › Drain pump kit available as accessory
- › Fresh air intake integrated in the same system thus reducing installation cost as no additional ventilation device is required

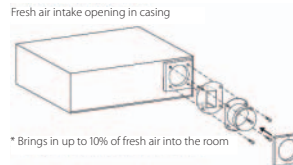

- › Reduced energy consumption thanks to specially developed DC fan motor and drain pump

Efficiency data		FHQ + RZQSG	71C + 71L3V1	100C + 100L9V1	125C + 125L9V1	140C + 140L9V1	100C + 100L8Y1	125C + 125L8Y1	140C + 140LY1			
Cooling capacity	Nom.	kW	6.8	9.5	12.0	13.4	9.5	12.0	13.4			
Heating capacity	Nom.	kW	7.5	10.8	13.5	15.5	10.8	13.5	15.5			
Power input	Cooling	Nom.	kW	1.97	2.96	4.15	4.45	2.96	4.45			
	Heating	Nom.	kW	1.88	2.99	3.73	4.54	2.99	4.54			
Seasonal efficiency (according to EN14825)	Cooling	Energy label	A+		-	A+		-				
		P _{design}	kW	6.80	9.50	12.00	-	9.5	12	-		
		SEER	5.61		-		5.61		-			
	Heating (Average climate)	Energy label	A		A+		A		A+			
		P _{design}	kW	7.60		-		7.6		-		
		SCOP	3.90		3.91		4.01		3.91		4.01	
Annual energy consumption	kWh	2,727	2,722	2,654	-	2,722	2,654	-				
Nominal efficiency	EER	3.46		3.21		2.89		3.01		3.01		
	COP	4.00		3.61		3.62		3.61		3.62		
	Annual energy consumption	kWh	985		1,480		2,075		-		2,225	
	Energy label	Cooling/Heating	A/A		C/A		-		A/A		C/A	

Indoor unit		FHQ	71C	100C	125C	140C	100C	125C	140C	
Dimensions	Unit	HeightxWidthxDepth	mm 235x1,270x690		235x1,590x690					
Weight	Unit	kg	32		38					
Air filter	Type	Resin net with mold resistance								
Fan - Air flow rate	Cooling	High/Nom./Low	m ³ /min	20.5/17/14	28/24/20	31/27/23	34/29/24	28/24/20	31/27/23	34/29/24
	Heating	High/Nom./Low	m ³ /min	20.5/17/14	28/24/20	31/27/23	34/29/24	28/24/20	31/27/23	34/29/24
Sound power level	Cooling		dBA	55	60	62	64	60	62	64
	Heating		dBA	55	60	62	64	60	62	64
Sound pressure level	Cooling	High/Nom./Low	dBA	38/36/34	42/38/34	44/41/37	46/42/38	42/38/34	44/41/37	46/42/38
	Heating	High/Nom./Low	dBA	38/36/34	42/38/34	44/41/37	46/42/38	42/38/34	44/41/37	46/42/38
Control systems	Infrared remote control	BRC7G53								
	Wired remote control	BRC1D52 / BRC1E52A/B								
Power supply	Phase / Frequency / Voltage	Hz / V	1~ / 50/60 / 220-240/220							

Outdoor unit		RZQSG	71L3V1	100L9V1	125L9V1	140L9V1	100L8Y1	125L8Y1	140LY1	
Dimensions	Unit	HeightxWidthxDepth	mm 770x900x320		990x940x320		1,430x940x320		990x940x320	
Weight	Unit	kg	67		72		74		95	
Sound power level	Cooling		dBA 65		70		69		70	
Sound pressure level	Cooling	Nom./Silent operation	dBA 49/47		53/-		54/-		53/-	
	Heating	Nom.	dBA 51		57		58		54	
	Night quiet mode	Level 1	dBA -		-		49		57	
Operation range	Cooling	Ambient	Min.-Max.	°CDB -15~-46						
	Heating	Ambient	Min.-Max.	°CWB -15~-15.5						
Refrigerant	Type/Charge/GWP	kg/TCO ₂ eq	R-410A/2.75/5.7/2,087.5		R-410A/2.9/6.1/2,087.5		R-410A/4.0/8.4/2,087.5		R-410A/2.9/6.1/2,087.5	
Piping connections	Liquid	OD	mm 9.52							
	Gas	OD	mm 15.9							
	Piping length	OU - IU	Max.	m 50						
		System	Equivalent	m 70						
		Chargeless		m 30						
		Additional refrigerant charge	kg/m	See installation manual						
Level difference	IU - OU	Max.	m 15		30.0					
	IU - IU	Max.	m		0.5					
Power supply	Phase / Frequency / Voltage	Hz / V	1~ / 50 / 220-240				3N~ / 50 / 380-415			
Current - 50Hz	Maximum fuse amps (MFA)	A	25		40		20		25	

(1) EER/COP according to Eurovent 2012, for use outside EU only (2) MFA is used to select the circuit breaker and the ground fault circuit interrupter (earth leakage circuit breaker) For more detailed information on each combination, please refer to the electrical data drawing.

Ceiling suspended unit

For wide rooms with no false ceilings nor free floor space

For combination with Seasonal Smart ensures best in class quality, highest efficiency and performance



Efficiency data		FHQ + RZQG	71C + 71L9V1	100C + 100L9V1	125C + 125L9V1	140C + 140L9V1	71C + 71L8Y1	100C + 100L8Y1	125C + 125L8Y1	140C + 140LY1	
Cooling capacity	Nom.	kW	6.8	9.5	12.0	13.4	6.8	9.5	12.0	13.4	
Heating capacity	Nom.	kW	7.5	10.8	13.5	15.5	7.5	10.8	13.5	15.5	
Power input	Cooling	Nom.	kW	1.78	2.49	3.58	4.05	1.78	2.49	3.58	4.05
	Heating	Nom.	kW	1.82	2.60	3.48	4.27	1.82	2.60	3.48	4.27
Seasonal efficiency (according to EN14825)	Cooling	Energy label	A++		A+	-	A++		A+	-	
		Pdesign	kW	6.80	9.50	12.00	-	6.8	9.5	12	-
		SEER		6.95	6.11	6.01	-	6.95	6.11	6.01	-
	Heating (Average climate)	Annual energy consumption	kWh	343	545	699	-	343	545	699	-
		Energy label	A+		A++	A+	-	A+	A++	A+	-
		Pdesign	kW	7.60	11.30	14.13	-	7.6	11.3	14.13	-
Nominal efficiency	EER	SCOP		4.32	4.61	4.23	-	4.32	4.61	4.23	-
		Annual energy consumption	kWh	2,463	3,432	4,677	-	2,463	3,432	4,677	-
	COP		3.82	3.81	3.35	3.31	3.82	3.81	3.35	3.31	
Annual energy consumption	Energy label	Cooling/Heating	A/A		-		A/A		-		

Indoor unit		FHQ	71C	100C	125C	140C	71C	100C	125C	140C	
Dimensions	Unit	HeightxWidthxDepth	mm	235x1,270x690			235x1,270x690		235x1,270x690		
Weight	Unit		kg	32	38			32	38		
Air filter	Type	Resin net with mold resistance									
Fan - Air flow rate	Cooling	High/Nom./Low	m³/min	20.5/17/14	28/24/20	31/27/23	34/29/24	20.5/17/14	28/24/20	31/27/23	34/29/24
	Heating	High/Nom./Low	m³/min	20.5/17/14	28/24/20	31/27/23	34/29/24	20.5/17/14	28/24/20	31/27/23	34/29/24
Sound power level	Cooling		dB(A)	55	60	62	64	55	60	62	64
	Heating		dB(A)	55	60	62	64	55	60	62	64
Sound pressure level	Cooling	High/Nom./Low	dB(A)	38/36/34	42/38/34	44/41/37	46/42/38	38/36/34	42/38/34	44/41/37	46/42/38
	Heating	High/Nom./Low	dB(A)	38/36/34	42/38/34	44/41/37	46/42/38	38/36/34	42/38/34	44/41/37	46/42/38
Control systems	Infrared remote control		BRC7G53								
	Wired remote control		BRC1D52 / BRC1E52A/B								
Power supply	Phase / Frequency / Voltage		Hz / V	1~ / 50/60 / 220-240/220							

Outdoor unit		RZQG	71L9V1	100L9V1	125L9V1	140L9V1	71L8Y1	100L8Y1	125L8Y1	140LY1	
Dimensions	Unit	HeightxWidthxDepth	mm	990x940x320			1,430x940x320		990x940x320		
Weight	Unit		kg	69	95			80	101		
Sound power level	Cooling		dB(A)	64	66	67	69	64	66	67	69
Sound pressure level	Cooling	Nom.	dB(A)	48	50	51	52	48	50	51	52
	Heating	Nom.	dB(A)	50	52	53		50	52	53	
Operation range	Night quiet mode	Level 1	dB(A)	43	45			43	45		
	Cooling	Ambient	Min.-Max.	-15~-50							
Refrigerant	Heating	Ambient	Min.-Max.	-20~-15.5							
	Type/Charge/GWP	kg/TCO ₂ eq		R-410A/2.9/6.1/2,087.5			R-410A/4.0/8.4/2,087.5		R-410A/2.9/6.1/2,087.5		R-410A/4.0/8.4/2,087.5
Piping connections	Liquid	OD	mm	9.52							
	Gas	OD	mm	15.9							
Piping length	OU - IU	Max.	m	50	75			50	75		
	System	Equivalent	m	70	90			70	90		
Additional refrigerant charge	Chargeless	m		30							
	Level difference	IU - OU	Max.	See installation manual							
Power supply	IU - IU	Max.	m	30.0							
	IU - IU	Max.	m	0.5							
Phase / Frequency / Voltage	Hz / V		1~ / 50 / 220-240			3N~ / 50 / 380-415					
Current - 50Hz	Maximum fuse amps (MFA)		A	25	40			16	25		

(1) EER/COP according to Eurovent 2012, for use outside EU only (2) MFA is used to select the circuit breaker and the ground fault circuit interrupter (earth leakage circuit breaker). For more detailed information on each combination, please refer to the electrical data drawing.

Ceiling suspended unit

For wide rooms with no false ceilings nor free floor space

- › Ideal solution for commercial spaces with no or narrow false ceilings
- › Exclusively offered for pair applications
- › Can easily be installed in both new and refurbishment projects
- › Air filter removes airborne dust particles to ensure a steady supply of clean air
- › Decrease of temperature variation by automatic fan speed selection or freely selectable 3-step fan speed.
- › Easy installation and maintenance



Efficiency data		AHQ + AZQS	71C + 71BV1	100C + 100B8V1	125C + 125B8V1	140C + 140B8V1	100C + 100BY1	125C + 125BY1	140C + 140BY1	
Cooling capacity	Nom.	kW	6.8	9.5	12.1	13.0	9.5	12.1	13.0	
Heating capacity	Nom.	kW	7.5	10.8	13.5	15.5	10.8	13.5	15.5	
Power input	Cooling	Nom.	kW	2.24	3.62	4.60	4.32	3.62	4.60	
	Heating	Nom.	kW	2.46	3.17	3.74	4.55	3.17	4.55	
Seasonal efficiency (according to EN14825)	Cooling	Energy label	B		-		B		-	
		Pdesign	kW	6.80	9.50	-		9.50	-	
		SEER		4.65	4.60	-		4.60	-	
	Heating (Average climate)	Energy label	A		-		A		-	
		Pdesign	kW	6.33	7.60	-		7.60	-	
		SCOP		3.80		-		3.80	-	
Nominal efficiency	EER		3.03	2.62	2.63	3.01	2.62	2.63	3.01	
	COP		3.05	3.41	3.61	3.41	3.61	3.41	3.61	
	Annual energy consumption	kWh	1,120	1,810	2,300	-	1,810	2,300	-	
	Energy label	Cooling/Heating	B/D	D/B	D/A	-	D/B	D/A	-	

Indoor unit		AHQ	71C	100C	125C	140C	100C	125C	140C	
Dimensions	Unit	HeightxWidthxDepth	mm	260x1,320x634	260x1,538x634	260x1,786x634	285x1,902x680	260x1,538x634	260x1,786x634	285x1,902x680
Weight	Unit		kg	38	45	54	70	45	54	70
Air filter	Type	Removable / washable								
Fan - Air flow rate	Cooling	High/Nom./Low	m³/min	23.8/21.3/18.9	31.1/27.8/24.8	34.4/30.6/27.2	43.9/39.1/28.3	31.1/27.8/24.8	34.4/30.6/27.2	43.9/39.1/28.3
	Heating	High/Nom./Low	m³/min	23.8/21.3/18.9	31.1/27.8/24.8	34.4/30.6/27.2	43.9/39.1/28.3	31.1/27.8/24.8	34.4/30.6/27.2	43.9/39.1/28.3
Sound power level	Cooling		dBA	59	64	69	70	64	69	70
	Heating		dBA	62	64	69	70	64	69	70
Sound pressure level	Cooling	High/Nom./Low	dBA	49/48/46	52/47/46	52/50/49	56/53/46	52/47/46	52/50/49	56/53/46
	Heating	High/Nom./Low	dBA	49/48/46	52/47/46	52/50/49	56/53/46	52/47/46	52/50/49	56/53/46
Control systems	Infrared remote control	ARCWLA								
	Wired remote control	ARCWB								
Power supply	Phase / Frequency / Voltage	Hz / V	1~ / 50 / 220-240							

Outdoor unit		AZQS	71BV1	100B8V1	125B8V1	140B8V1	100BY1	125BY1	140BY1	
Dimensions	Unit	HeightxWidthxDepth	mm	770x900x320	990x940x320	1,430x940x320	990x940x320	1,430x940x320	1,430x940x320	
Weight	Unit		kg	67	72.8	74.3	94.9	82	101	
Sound power level	Cooling		dBA	64	70	71	70	71	70	
Sound pressure level	Cooling	Nom.	dBA	48	53	54	53	54	53	
	Heating	Nom.	dBA	50	57	58	54	57	58	
	Night quiet mode	Level 1	dBA	43	49					
Operation range	Cooling	Ambient	Min.-Max.	°CDB					-5~46	
	Heating	Ambient	Min.-Max.	°CWB					-15~-15.5	
Refrigerant	Type/Charge/GWP	kg/TCO ₂ eq	R-410A/2.75/5.7/2,087.5	R-410A/2.9/6.1/2,087.5	R-410A/4.0/8.4/2,087.5	R-410A/2.9/6.1/2,087.5	R-410A/4.0/8.4/2,087.5			
Piping connections	Liquid	OD	mm	9.52						
	Gas	OD	mm	15.9						
	Piping length	OU - IU	Max.	m	50					
		System	Equivalent	m	70					
		Chargeless	m	30						
		Additional refrigerant charge	kg/m	See installation manual						
Level difference	IU - OU	Max.	m	30.0						
	IU - IU	Max.	m	-	0.5					
Power supply	Phase / Frequency / Voltage	Hz / V	1~ / 50 / 220-240			3N~ / 50 / 380-415				
Current - 50Hz	Maximum fuse amps (MFA)	A	20	32	40	16	20	25		

(1) EER/COP according to Eurovent 2012, for use outside EU only (2) MFA is used to select the circuit breaker and the ground fault circuit interrupter (earth leakage circuit breaker). For more detailed information on each combination, please refer to the electrical data drawing.

4-way blow ceiling suspended unit

Unique Daikin unit for high rooms with no false ceilings nor free floor space

Combination with Seasonal Smart ensures best in class quality, highest efficiency and performance

- › Even rooms with ceilings up to 3.5m can be heated up or cooled down very easily without capacity loss
- › Individual flap control: flexibility to suit every room layout without changing the location of the unit!
- › 5 different discharge angles between 0 and 60° can be programmed via the remote control
- › Stylish unit blends easily with any interior. The flaps close entirely when the unit is not operating and there are no air intake grilles visible
- › Optimum comfort guaranteed with automatic air flow adjustment to the required load
- › No optional adapter needed for DIII-connection, link your unit into the wider building management system



- › Standard drain pump with 500mm lift increases flexibility and installation speed

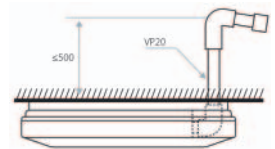

Efficiency data			FUQ + RZQG	71C + 71L9V1	100C + 100L9V1	125C + 125L9V1	71C + 71L8Y1	100C + 100L8Y1	125C + 125L8Y1	
Cooling capacity	Nom.	kW		6.8	9.5	12.0	6.8	9.5	12.0	
Heating capacity	Nom.	kW		7.5	10.8	13.5	7.5	10.8	13.5	
Power input	Cooling	Nom.	kW	1.68	2.46	3.54	1.68	2.46	3.54	
	Heating	Nom.	kW	1.84	2.73	3.95	1.84	2.73	3.95	
Seasonal efficiency (according to EN14825)	Cooling	Energy label		A++		A+		A++		
		Pdesign	kW	6.80	9.50	12.00	6.8	9.5	12	
		SEER		6.50	6.11	5.61	6.5	6.11	5.61	
	Heating (Average climate)	Annual energy consumption	kWh	367	545	749	367	545	749	
		Energy label		A+						
		Pdesign	kW	7.60	11.30	14.13	7.6	11.3	14.13	
Nominal efficiency	EER	COP		4.05	3.86	3.39	4.05	3.86	3.39	
		Annual energy consumption	kWh	840	1,230	1,770	840	1,230	1,770	
	Energy label	Cooling/Heating		A/A		A/B		A/A		A/B

Indoor unit			FUQ	71C	100C	125C	71C	100C	125C
Dimensions	Unit	HeightxWidthxDepth	mm	198x950x950					
Weight	Unit		kg	25	26		25	26	
Air filter	Type			Resin net with mold resistance					
Fan - Air flow rate	Cooling	High/Nom./Low	m³/min	23/19.5/16	31/25.5/20	32.5/26.5/20.5	23/19.5/16	31/25.5/20	32.5/26.5/20.5
	Heating	High/Nom./Low	m³/min	23/19.5/16	31/25.5/20	32.5/26.5/20.5	23/19.5/16	31/25.5/20	32.5/26.5/20.5
Sound power level	Cooling		dBA	59	64	65	59	64	65
	Heating		dBA	59	64	65	59	64	65
Sound pressure level	Cooling	High/Nom./Low	dBA	41/38/35	46/42/39	47/43/40	41/38/35	46/42/39	47/43/40
	Heating	High/Nom./Low	dBA	41/38/35	46/42/39	47/43/40	41/38/35	46/42/39	47/43/40
Control systems	Infrared remote control			BRC7C58					
	Wired remote control			BRC1D52 / BRC1E52A/B					
Power supply	Phase / Frequency / Voltage		Hz / V	1~ / 50/60 / 220-240/220					

Outdoor unit			RZQG	71L9V1	100L9V1	125L9V1	71L8Y1	100L8Y1	125L8Y1
Dimensions	Unit	HeightxWidthxDepth	mm	990x940x320	1,430x940x320		990x940x320	1,430x940x320	
Weight	Unit		kg	69	95		80	101	
Sound power level	Cooling		dBA	64	66	67	64	66	67
Sound pressure level	Cooling	Nom.	dBA	48	50	51	48	50	51
	Heating	Nom.	dBA	50	52	53	50	52	53
Operation range	Night quiet mode	Level 1	dBA	43	45		43	45	
	Cooling	Ambient	Min.-Max.	-15~50					
Refrigerant	Heating	Ambient	Min.-Max.	-20~-15.5					
	Type/Charge/GWP		kg/TCO ₂ eq	R-410A/2.9/6.1/2,087.5	R-410A/4.0/8.4/2,087.5		R-410A/2.9/6.1/2,087.5	R-410A/4.0/8.4/2,087.5	
Piping connections	Liquid	OD	mm	9.52					
	Gas	OD	mm	15.9					
Piping length	OU - IU	Max.	m	50	75		50	75	
		System Equivalent	m	70	90		70	90	
	Additional refrigerant charge	Chargeless	m	30					
		Level difference	IU - OU	Max.	See installation manual				
Power supply	IU - IU	Max.	m	30.0					
	Phase / Frequency / Voltage		Hz / V	1~ / 50 / 220-240			3N~ / 50 / 380-415		
Current - 50Hz	Maximum fuse amps (MFA)		A	20	32	40	16	20	25

(1) EER/COP according to Eurovent 2012, for use outside EU only (2) MFA is used to select the circuit breaker and the ground fault circuit interrupter (earth leakage circuit breaker). For more detailed information on each combination, please refer to the electrical data drawing.

Wall mounted unit

For rooms with no false ceilings nor free floor space

Combination with Seasonal Classic ensures good value for money for all types of commercial applications

- › Flat, stylish front panel blends easily within any interior décor and is easier to clean
- › Can easily be installed in both new and refurbishment projects
- › Reduced energy consumption thanks to specially developed DC fan motor
- › The air is comfortably spread up- and downwards thanks to 5 different discharge angles that can be programmed via the remote control
- › Maintenance operations can be performed easily from the front of the unit
- › Flexible to install as the largest casing only weighs 17kg and piping connection can be done at the bottom, left or right of the unit

- › Optimum comfort guaranteed with automatic air-flow volume control as this minimises the difference between room and required temperature. No action required from occupants to meet the desired temperature.
- › No optional adapter needed for DIII-connection, link your unit into the wider building management system.

Efficiency data				FAQ + RZQSG	71C + 71L3V1	100C + 100L9V1	100C + 100L8Y1	
Cooling capacity	Nom.		kW		6.8		9.5	
Heating capacity	Nom.		kW		7.5		10.8	
Power input	Cooling	Nom.	kW		2.12		3.16	
	Heating	Nom.	kW		2.08		3.17	
Seasonal efficiency (according to EN14825)	Cooling	Energy label				A+		
		Pdesign	kW		6.80		9.50	
		SEER			6.05		5.61	
		Annual energy consumption	kWh		393		593	
	Heating (Average climate)	Energy label				A		A+
		Pdesign	kW		6.00		6.81	
		SCOP			3.90		4.01	
		Annual energy consumption	kWh		2,155		2,378	
Nominal efficiency	EER				3.21		3.01	
	COP				3.61		3.41	
	Annual energy consumption		kWh		1,060		1,580	
	Energy label	Cooling/Heating			A/A		B/B	

Indoor unit				FAQ	71C	100C
Dimensions	Unit	HeightxWidthxDepth		mm	290x1,050x238	340x1,200x240
Weight	Unit			kg	13	17
Fan - Air flow rate	Cooling	High/Nom./Low	m ³ /min		18/16/14	26/23/19
	Heating	High/Nom./Low	m ³ /min		18/16/14	26/23/19
Sound power level	Cooling			dBA	61	65
	Heating			dBA	61	65
Sound pressure level	Cooling	High/Nom./Low	dBA		45/42/40	49/45/41
	Heating	High/Nom./Low	dBA		45/42/40	49/45/41
Control systems	Infrared remote control				BRC7EB518	
	Wired remote control				BRC1D52 / BRC1E52A/B	
Power supply	Phase / Frequency / Voltage		Hz / V		1~ / 50/60 / 220-240/220	

Outdoor unit				RZQSG	71L3V1	100L9V1	100L8Y1	
Dimensions	Unit	HeightxWidthxDepth		mm	770x900x320	990x940x320		
Weight	Unit			kg	67	72	82	
Sound power level	Cooling			dBA	65	70	69	
Sound pressure level	Cooling	Nom./Silent operation	dBA		49/47	53/-		
	Heating	Nom.	dBA		51	57		
	Night quiet mode	Level 1	dBA		-	49		
Operation range	Cooling	Ambient	Min.-Max.	°CDB	-15.0~46		-15~46	
	Heating	Ambient	Min.-Max.	°CWB	-15~15.5			
Refrigerant	Type/Charge/GWP			kg/TCO ₂ eq	R-410A/2.75/5.7/2,087.5	R-410A/2.9/6.1/2,087.5		
Piping connections	Liquid	OD		mm		9.52		
	Gas	OD		mm		15.9		
	Piping length	OU - IU	Max.	m		50		
		System	Equivalent	m		70		
			Chargeless	m		30		
Additional refrigerant charge				kg/m	See installation manual			
Level difference	IU - OU	Max.	m		15	30.0		
	IU - IU	Max.	m			0.5		
Power supply	Phase / Frequency / Voltage		Hz / V		1~ / 50 / 220-240		3N~ / 50 / 380-415	
Current - 50Hz	Maximum fuse amps (MFA)		A		20	32	20	

(1) EER/COP according to Eurovent 2012, for use outside EU only (2) MFA is used to select the circuit breaker and the ground fault circuit interrupter (earth leakage circuit breaker). For more detailed information on each combination, please refer to the electrical data drawing.

Wall mounted unit

For rooms with no false ceilings nor free floor space

› Combination with Seasonal Smart ensures best in class quality, highest efficiency and performance



Efficiency data			FAQ + RZQG	71C + 71L9V1	100C + 100L9V1	71C + 71L8Y1	100C + 100L8Y1
Cooling capacity	Nom.		kW	6.8	9.5	6.8	9.5
Heating capacity	Nom.		kW	7.5	10.8	7.5	10.8
Power input	Cooling	Nom.	kW	2.00	2.63	2.00	2.63
	Heating	Nom.	kW	2.03	3.00	2.03	3.00
Seasonal efficiency (according to EN14825)	Cooling	Energy label		A++			
		Pdesign	kW	6.80	9.50	6.8	9.5
		SEER		6.51	6.11	6.51	6.11
	Annual energy consumption		kWh	366	545	366	545
	Heating (Average climate)	Energy label		A+			
		Pdesign	kW	6.33	10.20	6.33	10.2
SCOP			4.02	4.01	4.02	4.01	
Annual energy consumption		kWh	2,205	3,562	2,205	3,562	
Nominal efficiency	EER			3.40	3.62	3.40	3.62
	COP			3.70	3.61	3.70	3.61
	Annual energy consumption		kWh	1,000	1,315	1,000	1,315
	Energy label	Cooling/Heating		A/A			

Indoor unit			FAQ	71C	100C
Dimensions	Unit	HeightxWidthxDp	mm	290x1,050x238	340x1,200x240
Weight	Unit		kg	13	17
Fan - Air flow rate	Cooling	High/Nom./Low	m ³ /min	18/16/14	26/23/19
	Heating	High/Nom./Low	m ³ /min	18/16/14	26/23/19
Sound power level	Cooling		dB(A)	61	65
	Heating		dB(A)	61	65
Sound pressure level	Cooling	High/Nom./Low	dB(A)	45/42/40	49/45/41
	Heating	High/Nom./Low	dB(A)	45/42/40	49/45/41
Control systems	Infrared remote control			BRC7EB518	
	Wired remote control			BRC1D52 / BRC1E52A/B	
Power supply	Phase / Frequency / Voltage		Hz / V	1~ / 50/60 / 220-240/220	

Outdoor unit			RZQG	71L9V1	100L9V1	71L8Y1	100L8Y1
Dimensions	Unit	HeightxWidthxDp	mm	990x940x320	1,430x940x320	990x940x320	1,430x940x320
Weight	Unit		kg	69	95	80	101
Sound power level	Cooling		dB(A)	64	66	64	66
Sound pressure level	Cooling	Nom.	dB(A)	48	50	48	50
	Heating	Nom.	dB(A)	50	52	50	52
	Night quiet mode	Level 1	dB(A)	43	45	43	45
Operation range	Cooling	Ambient	Min.-Max. °CDB	-15~-50			
	Heating	Ambient	Min.-Max. °CWB	-20~-15.5			
Refrigerant	Type/Charge/GWP		kg/TCO ₂ eq	R-410A/2.9/6.1/2,087.5	R-410A/4.0/8.4/2,087.5	R-410A/2.9/6.1/2,087.5	R-410A/4.0/8.4/2,087.5
Piping connections	Liquid	OD	mm	9.52			
	Gas	OD	mm	15.9			
Piping length	OU - IU	Max.	m	50	75	50	75
		System Equivalent	m	70	90	70	90
	Chargeless		m	30			
		Additional refrigerant charge	kg/m	See installation manual			
Level difference	IU - OU	Max.	m	30.0			
	IU - IU	Max.	m	0.5			
Power supply	Phase / Frequency / Voltage		Hz / V	1~ / 50 / 220-240		3N~ / 50 / 380-415	
Current - 50Hz	Maximum fuse amps (MFA)		A	-		16	20

(1) EER/COP according to Eurovent 2012, for use outside EU only (2) MFA is used to select the circuit breaker and the ground fault circuit interrupter (earth leakage circuit breaker). For more detailed information on each combination, please refer to the electrical data drawing.

Floor standing unit

For commercial spaces with high ceilings

Combination with Seasonal Classic ensures good value for money for all types of commercial applications

- > Ideal solution for commercial and busy environments
- > Decrease of temperature variation by automatic fan speed selection or freely selectable 3-step fan speed.
- > Improved comfort as a result of better airflow distribution from the vertical out blow which allows manual adjustment of air outlet blades at the top of the unit.
- > Selectable horizontal out blow to better suit the layout of the room (via wired remote controller BRC1E52)
- > No optional adapter needed for DIII-connection, link your unit into the wider building management system.

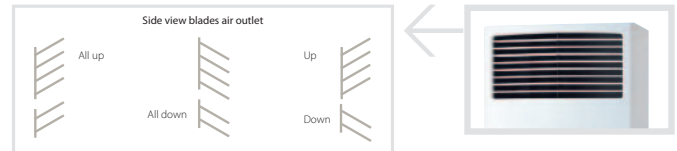

Efficiency data			FVQ + RZQSG	71C + 71L3V1	100C + 100L9V1	125C + 125L9V1	140C + 140L9V1	100C + 100L8Y1	125C + 125L8Y1	140C + 140LY1	
Cooling capacity	Nom.	kW	6.8	9.5	12.0	13.4	9.5	12.0	13.4		
Heating capacity	Nom.	kW	7.5	10.8	13.5	15.5	10.8	13.5	15.5		
Power input	Cooling	Nom.	kW	2.12	2.96	4.27	4.45	2.96	4.27	4.45	
	Heating	Nom.	kW	2.08	2.99	3.96	4.54	2.99	3.96	4.54	
Seasonal efficiency (according to EN14825)	Cooling	Energy label		A			-	A		-	
		Pdesign	kW	6.80	9.50	12.00	-	9.5	12	-	
		SEER		5.50			-	5.5		-	
	Heating (Average climate)	Annual energy consumption	kWh	433	605	764	-	605	764	-	
		Energy label		A		A+	A	-	A+	A	-
		Pdesign	kW	6.33	7.60		-	7.6		-	
Nominal efficiency	EER		3.21		2.81	3.01	3.21	2.81	3.01		
	COP		3.61		3.41		3.61	3.41			
	Annual energy consumption	kWh	1,060	1,480	2,135	2,225	1,480	2,135	2,225		
	Energy label	Cooling/Heating	A/A		A/B	-	A/A	C/B	-		

Indoor unit			FVQ	71C	100C	125C	140C	100C	125C	140C
Dimensions	Unit	HeightxWidthxDepth	mm	1,850x600x270		1,850x600x350				
Weight	Unit		kg	39	47					
Air filter	Type			Resin net with mold resistance						
Fan - Air flow rate	Cooling	High/Nom./Low	m³/min	18/16/14	28/25/22	28/26/24	30/28/26	28/25/22	28/26/24	30/28/26
	Heating	High/Nom./Low	m³/min	18/16/14	28/25/22	28/26/24	30/28/26	28/25/22	28/26/24	30/28/26
Sound power level	Cooling		dBA	55	62	63	65	62	63	65
	Heating		dBA	55	62	63	65	62	63	65
Sound pressure level	Cooling	High/Nom./Low	dBA	43/41/38	50/47/44	51/48/46	53/51/48	50/47/44	51/48/46	53/51/48
	Heating	High/Nom./Low	dBA	43/41/38	50/47/44	51/48/46	53/51/48	50/47/44	51/48/46	53/51/48
Control systems	Wired remote control			BRC1D52 / BRC1E52A/B						
Power supply	Phase / Frequency / Voltage	Hz / V		1~ / 50/60 / 220-240/220						

Outdoor unit			RZQSG	71L3V1	100L9V1	125L9V1	140L9V1	100L8Y1	125L8Y1	140LY1
Dimensions	Unit	HeightxWidthxDepth	mm	770x900x320	990x940x320		1,430x940x320	990x940x320		1,430x940x320
Weight	Unit		kg	67	72	74	95	82		101
Sound power level	Cooling		dBA	65	70		69	70		69
Sound pressure level	Cooling	Nom./Silent operation	dBA	49/47	53/-	54/-	53/-		54/-	53/-
	Heating	Nom.	dBA	51	57	58	54	57	58	54
Operation range	Night quiet mode	Level 1	dBA	-	49					
	Cooling	Ambient	Min.-Max. °CDB	-15.0~46	-15~46					
	Heating	Ambient	Min.-Max. °CWB	-15~15.5						
Refrigerant	Type/Charge/GWP	kg/TCO ₂ eq		R-410A/2.75/5.7/2,087.5	R-410A/2.9/6.1/2,087.5		R-410A/4.0/8.4/2,087.5	R-410A/2.9/6.1/2,087.5		R-410A/4.0/8.4/2,087.5
Piping connections	Liquid	OD	mm	9.52						
	Gas	OD	mm	15.9						
Piping length	OU - IU	Max.	m	50						
	System	Equivalent	m	70						
		Chargeless	m	30						
	Additional refrigerant charge		kg/m	See installation manual						
Level difference	IU - OU	Max.	m	15	30.0					
	IU - IU	Max.	m	0.5						
Power supply	Phase / Frequency / Voltage	Hz / V		1~ / 50 / 220-240				3N~ / 50 / 380-415		
Current - 50Hz	Maximum fuse amps (MFA)	A	25	40			20		25	

(1) EER/COP according to Eurovent 2012, for use outside EU only (2) MFA is used to select the circuit breaker and the ground fault circuit interrupter (earth leakage circuit breaker). For more detailed information on each combination, please refer to the electrical data drawing.

Floor standing unit

For commercial spaces with high ceilings

Combination with Seasonal Smart ensures best in class quality, highest efficiency and performance

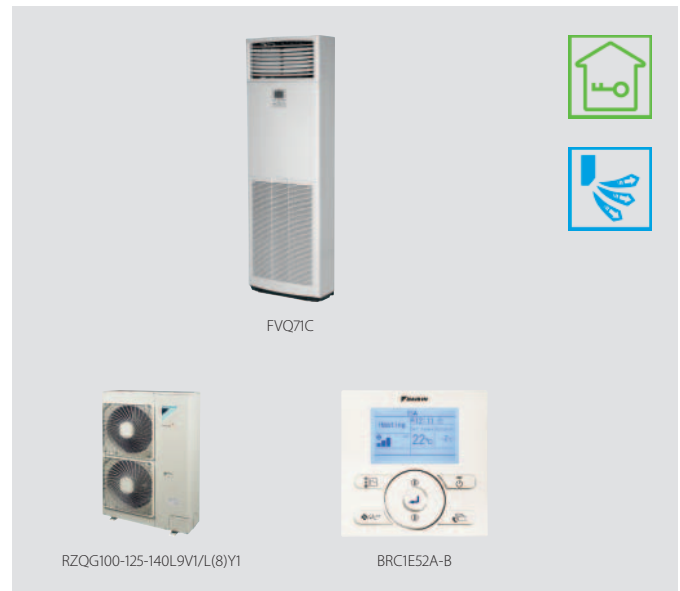

Efficiency data			FVQ + RZQG	71C + 71L9V1	100C + 100L9V1	125C + 125L9V1	140C + 140L9V1	71C + 71L8Y1	100C + 100L8Y1	125C + 125L8Y1	140C + 140L1Y1
Cooling capacity	Nom.		kW	6.8	9.5	12.0	13.4	6.8	9.5	12.0	13.4
Heating capacity	Nom.		kW	7.5	10.8	13.5	15.5	7.5	10.8	13.5	15.5
Power input	Cooling	Nom.	kW	2.02	2.49	3.74	4.17	2.02	2.49	3.74	4.17
	Heating	Nom.	kW	2.06	2.61	3.65	4.30	2.06	2.61	3.65	4.30
Seasonal efficiency (according to EN14825)	Cooling	Energy label		A++	A+	-	-	A++	A+	-	-
		Pdesign	kW	6.80	9.50	12.00	-	6.8	9.5	12	-
		SEER		6.31	5.61	-	-	6.31	5.61	-	-
	Heating (Average climate)	Annual energy consumption	kWh	378	593	749	-	378	593	749	-
		Energy label			A+	A	-	A+	A	-	-
		Pdesign	kW	6.33	11.30	-	-	6.33	11.3	-	-
Nominal efficiency	EER	SCOP		4.05	4.20	3.87	-	4.05	4.2	3.87	-
		Annual energy consumption	kWh	2,189	3,767	4,088	-	2,189	3,767	4,088	-
	COP	EER		3.37	3.81	3.21	-	3.37	3.81	3.21	-
		Annual energy consumption	kWh	3.64	4.14	3.70	3.61	3.64	4.14	3.70	3.61
Energy label	Cooling/Heating			A/A	-	-	A/A	-	-		

Indoor unit			FVQ	71C	100C	125C	140C	71C	100C	125C	140C
Dimensions	Unit	HeightxWidthxDepth	mm	1,850x600x270	1,850x600x350			1,850x600x270	1,850x600x350		
Weight	Unit		kg	39	47			39	47		
Air filter	Type			Resin net with mold resistance							
Fan - Air flow rate	Cooling	High/Nom./Low	m ³ /min	18/16/14	28/25/22	28/26/24	30/28/26	18/16/14	28/25/22	28/26/24	30/28/26
	Heating	High/Nom./Low	m ³ /min	18/16/14	28/25/22	28/26/24	30/28/26	18/16/14	28/25/22	28/26/24	30/28/26
Sound power level	Cooling		dB(A)	55	62	63	65	55	62	63	65
	Heating		dB(A)	55	62	63	65	55	62	63	65
Sound pressure level	Cooling	High/Nom./Low	dB(A)	43/41/38	50/47/44	51/48/46	53/51/48	43/41/38	50/47/44	51/48/46	53/51/48
	Heating	High/Nom./Low	dB(A)	43/41/38	50/47/44	51/48/46	53/51/48	43/41/38	50/47/44	51/48/46	53/51/48
Control systems	Wired remote control			BRC1D52 / BRCIE52A/B							
Power supply	Phase / Frequency / Voltage	Hz / V		1~ / 50/60 / 220-240/220							

Outdoor unit			RZQG	71L9V1	100L9V1	125L9V1	140L9V1	71L8Y1	100L8Y1	125L8Y1	140LY1	
Dimensions	Unit	HeightxWidthxDepth	mm	990x940x320	1,430x940x320			990x940x320	1,430x940x320			
Weight	Unit		kg	69	95			80	101			
Sound power level	Cooling		dB(A)	64	66	67	69	64	66	67	69	
Sound pressure level	Cooling	Nom.	dB(A)	48	50	51	52	48	50	51	52	
	Heating	Nom.	dB(A)	50	52	53	53	50	52	53	53	
Operation range	Night quiet mode	Level 1	dB(A)	43	45			43	45			
	Cooling	Ambient	Min.-Max. °CDB	-15~-50								
Refrigerant	Heating	Ambient	Min.-Max. °CWB	-20~-15.5								
	Type/Charge/GWP	kg/TCO ₂ eq		R-410A/2.9/61/2,087.5	R-410A/4.0/8.4/2,087.5			R-410A/2.9/61/2,087.5	R-410A/4.0/8.4/2,087.5			
Piping connections	Liquid	OD	mm	9.52								
	Gas	OD	mm	15.9								
	Piping length	OU - IU	Max.	m	50	75			50	75		
		System	Equivalent	m	70	90			70	90		
Additional refrigerant charge	Chargeless		m	30								
	Level difference	IU - OU	Max.	m	30.0							
		IU - IU	Max.	m	0.5							
Power supply	Phase / Frequency / Voltage	Hz / V		1~ / 50 / 220-240				3N~ / 50 / 380-415				
Current - 50Hz	Maximum fuse amps (MFA)	A		25	40			16	25			

(1) EER/COP according to Eurovent 2012, for use outside EU only (2) MFA is used to select the circuit breaker and the ground fault circuit interrupter (earth leakage circuit breaker). For more detailed information on each combination, please refer to the electrical data drawing.

Concealed floor standing unit

Designed to be concealed in walls

- › Ideal for installation in offices, hotels and residential applications
- › Discretely concealed in the ceiling: only the suction and discharge grilles are visible
- › Its low height (620 mm) enables the unit to fit perfectly beneath a window
- › Requires very little installation space as the depth is only 200mm

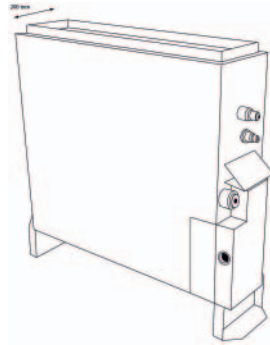

- › High ESP allows flexible installation

Efficiency data			FNQ + RXS	25A + 25L3	35A + 35L3	50A + 50L	60A + 60L
Cooling capacity	Nom.		kW	2.6	3.4	5.0	6.0
Heating capacity	Nom.		kW	3.20	4.00	5.80	7.00
Power input	Cooling	Nom.	kW	0.69	1.11	1.49	2.24
	Heating	Nom.	kW	0.80	1.15	1.74	2.25
Seasonal efficiency (according to EN14825)	Cooling	Energy label		A+			A
		Pdesign	kW	2.60	3.40	5.00	6.00
	SEER		5.63	5.65	5.72	5.51	
	Annual energy consumption	kWh	162	211	306	381	
	Heating (Average climate)	Energy label		A+			
	Pdesign	kW	2.80	2.90	4.00	4.60	
	SCOP		4.24	4.05	4.09	4.16	
	Annual energy consumption	kWh	925	1,002	1,369	1,548	
Nominal efficiency	EER			3.77	3.06	3.35	2.68
	COP			4.00	3.48	3.34	3.11
	Annual energy consumption	kWh		345	556	746	1,119
	Energy label	Cooling/Heating		A/A	B/B	A/C	D/D

Indoor unit			FNQ	25A	35A	50A	60A
Dimensions	Unit	HeightxWidthxDepth	mm	720x750x200			720x1,150x200
Weight	Unit		kg	23			30
Air filter	Type			Resin net with mold resistance			
Fan - Air flow rate	Cooling	High/Nom./Low	m³/min	8.7/8/7.3			16.0/14.8/13.5
	Heating	High/Nom./Low	m³/min	8.7/8/7.3			16.0/14.8/13.5
Fan - External static pressure	High/Nom.		Pa	48/30			49/40
Sound power level	Cooling		dBA	53			56
Sound pressure level	Cooling	High/Nom./Low	dBA	33/31/28			36/33/30
	Heating	High/Nom./Low	dBA	33/31/28			36/33/30
Control systems	Infrared remote control			BRC4C65			
	Wired remote control			BRC1E52A/B / BRC1D52			
Power supply	Phase / Frequency / Voltage		Hz / V	1~ / 50/60 / 220-240/220			

Outdoor unit			RXS	25L3	35L3	50L	60L	
Dimensions	Unit	HeightxWidthxDepth	mm	550x765x285			735x825x300	
Weight	Unit		kg	34			47	
Sound power level	Cooling		dBA	59	61		62	
	Heating		dBA	59	61		62	
Sound pressure level	Cooling	High/Low/Silent operation	dBA	46/-/43	48/-/44	48/44/-	49/46/-	
	Heating	High/Low/Silent operation	dBA	47/-/44	48/-/45	48/45/-	49/46/-	
Operation range	Cooling	Ambient	Min.-Max. °CDB	-10~46				
	Heating	Ambient	Min.-Max. °CWB	-15~18				
Refrigerant	Type/Charge/GWP		kg/TCO ₂ eq	R-410A/1.0/2.1/2,087.5	R-410A/1.2/2.5/2,087.5	R-410A/1.7/3.5/2,087.5	R-410A/1.5/3.1/2,087.5	
Piping connections	Liquid	OD	mm	6.35				
	Gas	OD	mm	9.5			12.7	
	Piping length	OU - IU	Max.	m	20			30
		System	Chargeless	m	10			-
	Additional refrigerant charge		kg/m	0.02 (for piping length exceeding 10m)				
Level difference	IU - OU	Max.	m	15			20.0	
Power supply	Phase / Frequency / Voltage		Hz / V	1~ / 50 / 220-240			1~ / 50 / 220-230-240	
Current - 50Hz	Maximum fuse amps (MFA)		A	16			20	

(1) EER/COP according to Eurovent 2012, for use outside EU only (2) Dimensions indoor unit include installation legs (3) MFA is used to select the circuit breaker and the ground fault circuit interrupter (earth leakage circuit breaker). For more detailed information on each combination, please refer to the electrical data drawing.

Sky Air

Outdoor units & Rooftops

Products overview outdoor units 204

Benefits overview outdoor units 204

Why choose Seasonal Smart 206

Pair, Twin, Triple, double twin applications 210

RZQSG-L3/9V1/L(8)Y1 210

RZQG-L9V1/L(8)Y1 211

RZQ-C 212

Pair applications 213

AZQS-B(8)V1/BY1 213

Rooftops 214





UATYQ-CY1 214

UATYP-AY1(B) 215

Options & accessories 216

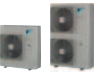
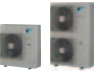
Products overview *SkyAir*

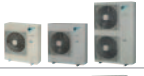
Pair, twin, triple & double twin application

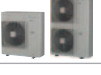
System	Type	Model	Product name		
		Seasonal Smart - Industry leading technology for commercial applications and server rooms, Telecom shelters, laboratories and IT applications - Top efficient outdoor units - Variable Refrigerant Temperature - Maximum piping length up to 75m - Re-use technology - Maximum piping length up to 50m - Extended operation range down to -20°C in heating and down to -15°C in cooling - Pair, twin, triple and double twin application		RZQG-L9V1	
		RZQG-L(8)Y1			
		Seasonal Classic - Technology and comfort combined for commercial applications - Top efficient outdoor units - Re-use technology - Operation range down to -15°C both cooling and in heating - Pair, twin, triple and double twin application		RZQSG-L3/L9V1	
		RZQSG-L(8)Y1			
		Super Inverter - Packaged system for commercial applications - For large commercial applications - Re-use technology - Pair, twin, triple and double twin applications		RZQ-C	
		Standard outdoor unit - Ideal solution for busy environments and small shops - Easy-to-mount outdoor units: roof, terrace or wall - Outdoor units with swing or scroll compressor - Exclusively offered for pair applications	AZQS-B8V1		
		AZQS-BY1			

Products overview Rooftops

Rooftops

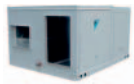
System	Type	Model	Product name	Refrigerant	
Air cooled	Heat pump	Rooftop Unit - Plug and play' for easy installation - High efficiency - Compact unit - Factory pre-charged refrigerant - Belt driven fan	UATYP-AY1(B)	R-407C	
		Rooftop Unit - Plug and play' for easy installation - High efficiency - Free cooling and fresh air intake possible - Field convertible return and supply air - Factory pre-charged refrigerant - Belt driven fan	UATYQ-CY1	R-410A	

Capacity class (kW)

71	100	125	140	200	250
•	•	•	•		
•	•	•	•		
•	•	•	•		
	•	•	•		
				•	•
•	•	•	•		
	•	•	•		

Capacity (class)

250	350	450	550	600	700	850	1000	1200
						•	•	•
•	•	•	•	•	•			



RZQG-L9V1/L(8)Y1

Daikin is leading the way towards more efficient and cost-effective comfort solutions with its Sky Air product range

Why choose Seasonal Smart?

✓ Best in class quality

✓ Advanced and leading technologies



✓ Highest seasonal efficiency values when compared with other systems under the same test conditions

✓ Flexible as no other



Top seasonal efficiency

- › Inverter control logic optimises efficiency
 - › Efficiency is enhanced even further thanks to the Variable Refrigerant Temperature settings
 - › Using a highly efficient swing compressor
 - › Losses are reduced in standby mode
 - › A++ label both in heating and cooling 
- FCQHG71/100F + RZQG71/100L9V1

Advanced and leading technologies

- › Variable refrigerant temperature to suit application requirements better: eliminating cold draughts by varying the evaporating temperature.



Flexible as no other



- › Reliable, efficient and flexible solution offered to meet the demanding needs of infrastructure cooling environments
- › Long pipe runs (up to 75m)
- › Wide operation range for cooling (down to 15°C) and for heating (down to -20°C)
- › Replacement technology: re-use of existing pipework of R-22 and R-407C systems
- › Wide range of indoor units connectable: wall mounted, concealed ceiling, cassette ...



Benefits for the installer

Whatever the installation requirements or restrictions, Seasonal Smart will be able to meet them thanks to:

- › R-22/R-407C replacement technology 
- › Wide operation range for cooling (down to -15°C) to suit even infrastructure cooling applications
- › Wide operation range for heating (down to -20°C) to be able to deliver heating in the most severe winters.
- › Long pipe runs of up to 75m
- › Easy accessibility to the gas cooled PCB (L9V1)
- › Easy to install discreetly against the wall thanks to the limited depth of the unit
- › Wide range of indoor units available

Benefits for the consultant

- › Market leader in terms of seasonal efficiency. The unit operates extremely efficiently throughout the whole summer and winter.
- › R-22/R-407C replacement technology: delivering major energy savings, rapid payback and cost-effective upgrade solution with minimum downtime
- › This system has been optimised to perform well in the most severe conditions.
- › Wide range of indoor units available to suit buildings with or without false ceilings

Benefits for the end user

- › Market leader in terms of seasonal efficiency which reduces your customers' electricity bills to a minimum all year round
- › Possibility to reduce sound level via settings on the remote controller
- › Wide range of stylish, comfortable and silent indoor units available
- › Possibility of integrating the unit into a Building Management system
- › Reliable system in all weather conditions

Infrastructure cooling. Why is it needed?



Telecom shelters

Server rooms

Laboratory

- > For rooms and enclosures that require round-the-clock cooling
- > Where continuous uptime is the absolute requirement for server data protection equipment protection

An infrastructure cooling system removes the heat that is constantly generated by IT, server rooms and business supporting equipment.

To serve the increasing digital and mobile data requirements of businesses and online consumers, the IT equipment, telecom and server infrastructure have to function round the clock. Unexpected or unplanned downtime is not only costly to businesses but also impacts end-consumers who depend on the continuous access to data connections for

day-to-day activities. 24/7 operations of the infrastructure in turn increase the heat loads generated within the IT/server rooms and telecom shelters. Therefore your business infrastructure requires **reliable, efficient** and **flexible** cooling to ensure maximum uptime while offering the best return on investment.

Why choose Daikin?

Daikin is the world's leader when it comes to heating and cooling. With over 90 years of innovation and engineering expertise in specialised cooling, Daikin offers a Sky Air solution that is **reliable, efficient** and **flexible** to meet the demanding needs of infrastructure cooling environments.



25%
BASIC COOLING
 Small split systems and Rooftops
 > low initial costs
 > higher running costs
 > limited flexibility

40%
SOPHISTICATED PRECISION COOLING
 Closed Control Systems
 > high investment cost
 > operation down to -20°C
 > precise temperature control ± 1°C deviation
 > humidity control
 > large footprint occupies
 > available rack space
 > free cooling and mixed operation

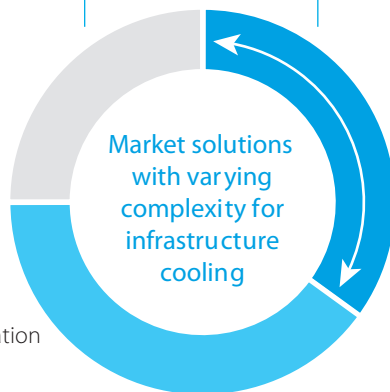

35%
RELIABLE CONTINUOUS COOLING
Sky Air and VRV systems
Good return on investment
 > low running costs
 > from better energy efficiency
 > low upfront costs
 > small physical footprint
 > free cooling option
Optimum reliability
 > constant cooling at 21-22°C
 > boosted capacity indoor systems
 > wide operation range
 > down to -15°C and up to +50°C
High flexibility
 > better suited indoor units
 > modular build up
 > controls (duty rotation)

Twin, triple and double twin applications



The benefits

Air conditioning in long or irregularly shaped rooms

A twin/triple/double twin application allows up to 4 indoor units to operate in L-shaped, U-shaped or long rooms powered by a single outdoor unit. All indoor units are controlled at the same time.

The widest choice

Different types of indoor units - wall mounted, concealed ceiling, cassettes etc - can be selected for twin/triple/double twin application

Ideal comfort in every part of the room

Delivery of optimal efficiency and comfort in each part of a long or irregularly shaped room.

Benefits for the installer

- › Less piping required as all indoor units can be connected to one single outdoor unit

Benefits for the consultant

- › Ideal solution for long or irregularly shaped rooms
- › Up to 4 indoor units can be connected to a single outdoor unit
- › The air flow is evenly spread into the area as smaller indoor units are installed on different locations in the room

Benefits for the end user

- › All indoor units are controlled at the same time and via 1 single wired remote controller
- › Only 1 outdoor unit standing on a roof, terrace or against an outside wall to control up to 4 indoor units
- › Same comfortable feeling through the entire room



Seasonal Classic



Seasonal Smart



Super Inverter



Pair, Twin, Triple, double twin

Technology and comfort combined for commercial applications

- › Top efficiency:
 - Energy labels up to A++ (cooling) /A+ (heating) for RZQG71/100L9V1 + FCQG71/100F
 - compressor that offers substantial efficiency improvements
 - control logic that optimises efficiency at the most frequently encountered operating conditions and that optimises the auxiliary modes (when the unit is not active)
 - heat exchangers that optimise the refrigerant flow at the most frequent operating conditions (temperature and load)
 - via improved nominal performances
- › Re-use of existing R-22 or R-407C technology



- › Guarantees operation in both heating and cooling mode down to -15°C
- › With a gas cooled PCB reliable cooling is guaranteed as it is not influenced by ambient temperature
- › Maximum piping length up to 50m, minimum piping length is 5m.
- › Outdoor units for pair, twin, triple, double twin application



RZQSG100-125L3/9V1/L(8)Y1

- › Daikin outdoor units are neat, sturdy and can easily be mounted on a roof or terrace or simply placed against an outside wall
- › Compatibility with D-BACS
- › Units optimized for seasonal efficiency give an indication on how efficient an air conditioner operates over an entire heating or cooling season.

Twin, triple and double twin application

capacity class	FCQH-G-F		FCQG-F				FFQ-C			FDXS-F(9)			FBQ-D				FHQ-C			FAQ-C		FNQ-A		
	71	35	50	60	71	35	50	60	35	50	60	35	50	60	71	35	50	60	71	71	35	50	60	
RZQSG71L3V1		2				2			2			2				2						2		
RZQSG100L9V1	RZQSG100L8Y1	3	2			3	2		3	2		3	2			3	2					3	2	
RZQSG125L9V1	RZQSG125L8Y1	4	3	2		4	3	2	4	3	2	4	3	2		4	3	2				4	3	2
RZQSG140L9V1	RZQSG140LY1	2	4	3		2	4	3		4	3		4	3		2	4	3		2	2	4	3	

Outdoor unit		RZQSG		71L3V1	100L9V1	125L9V1	140L9V1	100L8Y1	125L8Y1	140LY1	
Dimensions	Unit	HeightxWidthxDepth	mm	770x900x320	990x940x320		1,430x940x320	990x940x320		1,430x940x320	
Weight	Unit		kg	67	72	74	95	82		101	
Sound power level	Cooling		dBA	65	70		69		70	69	
Sound pressure level	Cooling	Nom./Silent operation	dBA	49/47	53/-	54/-	53/-		54/-	53/-	
	Heating	Nom.	dBA	51	57	58	54		57	58	
	Night quiet mode	Level 1	dBA	-						49	
Operation range	Cooling	Ambient	Min.-Max.	°CDB		-15~46					
	Heating	Ambient	Min.-Max.	°CWB		-15~-15.5					
Refrigerant	Type/Charge/GWP		kg/TCO ₂ eq	R-410A/2.75/5.7/2,087.5	R-410A/2.9/6.1/2,087.5		R-410A/4.0/8.4/2,087.5	R-410A/2.9/6.1/2,087.5		R-410A/4.0/8.4/2,087.5	
Piping connections	Liquid	OD	mm	9.52							
	Gas	OD	mm	15.9							
	Piping length	OU - IU	Max.	m	50						
		System	Equivalent	m	70						
		Chargeless		m	30						
	Additional refrigerant charge		kg/m	See installation manual							
Level difference	IU - OU	Max.	m	15						30.0	
	IU - IU	Max.	m	0.5							
Power supply	Phase / Frequency / Voltage		Hz / V	1~ / 50 / 220-240				3N~ / 50 / 380-415			
Current - 50Hz	Maximum fuse amps (MFA)		A	25	40			20		25	

(1) MFA is used to select the circuit breaker and the ground fault circuit interrupter (earth leakage circuit breaker). For more detailed information on each combination, please refer to the electrical data drawing.

Pair, Twin, Triple, double twin

Industry leading technology for commercial applications and even for technical rooms

- › Top efficiency:
 - energy labels up to A++ in both cooling and heating
 - compressor that offers substantial efficiency improvements
 - control logic that optimises efficiency at the most frequently encountered operating conditions and that optimises the auxiliary modes (when the unit is not active)
 - heat exchangers that optimise the refrigerant flow at the most frequent operating conditions (temperature and load)
 - via improved nominal performances
- › The perfect balance in efficiency and comfort thanks to Variable Refrigerant Temperature: top seasonal efficiency throughout most of the year and quick reaction speed on the hottest days.



- › Suits high sensible, infrastructure cooling applications
- › Re-use of existing R-22 or R-407C technology



- › Extended operation range down to -20°C in heating and down to -15°C in cooling
- › With a gas cooled PCB reliable cooling is guaranteed as it is not influenced by ambient temperature



- › Maximum piping length up to 75m, minimum piping length is 5m.
- › Outdoor units for pair, twin, triple, double twin application
- › Daikin outdoor units are neat, sturdy and can easily be mounted on a roof or terrace or simply placed against an outside wall
- › Compatibility with D-BACS
- › Units optimized for seasonal efficiency give an indication on how efficient an air conditioner operates over an entire heating or cooling season.

Twin, triple and double twin application

		FCQHG-F		FCQG-F		FFQ-C				FDXS-F (9)			FBQ-D				FHQ-C			FAQ-C			FUQ-C		FNQ-A		
capacity class		71	35	50	60	71	35	50	60	35	50	60	35	50	60	71	35	50	60	71	71	71	35	50	60		
RZQG71L9V1	RZQG71L8Y1		2				2				2					2								2			
RZQG100L9V1	RZQG100L8Y1		3	2			3	2			3	2				3	2							3	2		
RZQG125L9V1	RZQG125L8Y1		4	3	2		4	3	2		4	3	2			4	3	2						4	3	2	
RZQG140L9V1	RZQG140LY1	2	4	3			2	4	3			4	3			2	4	3			2	2	2	4	3		

Outdoor unit		RZQG		71L9V1	100L9V1	125L9V1	140L9V1	71L8Y1	100L8Y1	125L8Y1	140LY1	
Dimensions	Unit	HeightxWidthxDepth		mm	990x940x320	1,430x940x320			990x940x320	1,430x940x320		
Weight	Unit			kg	69	95			80	101		
Sound power level	Cooling			dBA	64	66	67	69	64	66	67	69
Sound pressure level	Cooling	Nom.		dBA	48	50	51	52	48	50	51	52
	Heating	Nom.		dBA	50	52	53		50	52	53	
	Night quiet mode	Level 1		dBA	43	45			43	45		
Operation range	Cooling	Ambient	Min.-Max.	°CDB	-15~50							
	Heating	Ambient	Min.-Max.	°CWB	-20~-15.5							
Refrigerant	Type/Charge/GWP	kg/TCO ₂ eq		R-410A/2.9/6.1/2,087.5	R-410A/4.0/8.4/2,087.5			R-410A/2.9/6.1/2,087.5	R-410A/4.0/8.4/2,087.5			
Piping connections	Liquid	OD		mm	9.52							
	Gas	OD		mm	15.9							
Piping length	OU - IU	Max.		m	50	75			50	75		
	System	Equivalent		m	70	90			70	90		
	Chargeless			m	30							
Additional refrigerant charge			kg/m	See installation manual								
Level difference	IU - OU	Max.		m	30.0							
	IU - IU	Max.		m	0.5							
Power supply	Phase / Frequency / Voltage		Hz / V	1~ / 50 / 220-240				3N~ / 50 / 380-415				
Current - 50Hz	Maximum fuse amps (MFA)		A	25	40			16	25			

(1) MFA is used to select the circuit breaker and the ground fault circuit interrupter (earth leakage circuit breaker). For more detailed information on each combination, please refer to the electrical data drawing.

Pair, Twin, Triple, double twin

Packaged system for commercial applications

- › Available as 20 and 25kW
- › Re-use of existing R-22 or R-407C technology



- › Guarantees operation in heating mode down to -15°C
- › Standard night quiet mode
- › Maximum piping length up to 100m
- › Maximum installation height difference up to 30m
- › Wide range of connectable indoor units



Twin, triple and double twin application

capacity class	FCQG-F					FFQ-C				FDXS-F(9)					FBQ-D					FHQ-C					FUQ-C			FAQ-C		FDQ-C		FNQ-A	
	50	60	71	100	125	50	60	50	60	50	60	71	100	125	50	60	71	100	125	71	100	125	71	100	125	50	60						
RZQ200C	4	3	3	2		4	3	4	3	4	3	3	2		4	3	3	2		3	2		3	2					4	3			
RZQ250C		4			2		4		4		4			4		2			2			2				2				4			

Outdoor unit				RZQ	200C			250C			
Dimensions	Unit	HeightxWidthxDepth		mm	1,680x930x765						
Weight	Unit			kg	183			184			
Sound power level	Cooling			dBA	78			78			
	Heating			dBA	78			78			
Sound pressure level	Nom.			dBA	57			57			
Operation range	Cooling	Ambient	Min.~Max.	°CDB	-5.0~46.0			-5.0~46.0			
	Heating	Ambient	Min.~Max.	°CWB	-15.0~15.0			-15.0~15.0			
Refrigerant	Type/Charge/GWP			kg/TCO ₂ eq	R-410A/8.3/17.3/2,087.5			R-410A/9.3/19.4/2,087.5			
Piping connections	Liquid	OD			mm	9.52			12.7		
	Gas	OD			mm	22.20			22.20		
	Piping length	OU - IU	Max.	m	100			100			
	Level difference	IU - OU	Max.	m	-			-			
Power supply	Phase / Frequency / Voltage			Hz / V	3N~ / 50 / 380-415			3N~ / 50 / 380-415			
Current - 50Hz	Maximum fuse amps (MFA)			A	20			20			

(1) MFA is used to select the circuit breaker and the ground fault circuit interrupter (earth leakage circuit breaker). For more detailed information on each combination, please refer to the electrical data drawing.

Pair application

Ideal solution for busy environments and small shops

- › Daikin outdoor units are neat, sturdy and can easily be mounted on a roof or terrace or simply placed against an outside wall
- › With a gas cooled PCB reliable cooling is guaranteed as it is not influenced by ambient temperature
- › Outdoor units are fitted with either a swing or scroll compressor, renowned for low noise and high energy efficiency
- › Exclusively offered for pair applications (capacity from 71 up to 140)
- › Units optimized for seasonal efficiency give an indication on how efficient an air conditioner operates over an entire heating or cooling season.



AZQS100-125B8V1/BY1

Pair application

capacity class	ACQ-D				ABQ-C				AHQ-C			
	71	100	125	140	71	100	125	140	71	100	125	140
AZQS-B(8)V1	v	v	v	v	v	v	v	v	v	v	v	v
AZQS-BY1		v	v	v		v	v	v		v	v	v

Outdoor unit		AZQS		71BV1	100B8V1	125B8V1	140B8V1	100BY1	125BY1	140BY1	
Dimensions	Unit	HeightxWidthxDepth	mm	770x900x320	990x940x320		1,430x940x320	990x940x320		1,430x940x320	
Weight	Unit		kg	67	72.8	74.3	94.9	82		101	
Sound power level	Cooling		dBA	64	70	71	70		71	70	
	Sound pressure level	Nom.	dBA	48	53	54	53		54	53	
level	Heating	Nom.	dBA	50	57	58	54	57	58	54	
	Night quiet mode	Level 1	dBA	43	49						
Operation range	Cooling	Ambient	Min.-Max.	°CDB						-5~46	
	Heating	Ambient	Min.-Max.	°CWB						-15~-15.5	
Refrigerant	Type/Charge/GWP		kg/TCO ₂ eq	R-410A/2.75/5.7/2,0875	R-410A/2.9/6.1/2,0875		R-410A/4.0/8.4/2,0875	R-410A/2.9/6.1/2,0875		R-410A/4.0/8.4/2,0875	
Piping connections	Liquid	OD	mm							9.52	
	Gas	OD	mm							15.9	
Piping length	OU - IU	Max.	m							50	
	System	Equivalent	m							70	
		Chargeless	m							30	
Additional refrigerant charge			kg/m							See installation manual	
Level difference	IU - OU	Max.	m							30.0	
	IU - IU	Max.	m	-							0.5
Power supply	Phase / Frequency / Voltage		Hz / V	1~ / 50 / 220-240				3N~ / 50 / 380-415			
Current - 50Hz	Maximum fuse amps (MFA)		A	20	32		40	16	20	25	

(1) MFA is used to select the circuit breaker and the ground fault circuit interrupter (earth leakage circuit breaker). For more detailed information on each combination, please refer to the electrical data drawing.

Rooftop

- › Easy to install 'plug and play' concept plus single installation configuration; no additional piping is required since indoor and outdoor sides are pre-connected
- › High efficiency and reliable scroll compressor
- › Wide operating range
- › Flat top unit design allows maximum use of warehouse and container space
- › Free cooling and fresh air intake possible with optional economiser
- › Convertible return and supply air: fan can be mounted in two directions
- › Factory pre-charged refrigerant ensures clean and efficient operation
- › Belt driven fan enables air volume and static pressure to be adjusted as required.
- › Adjustable fan pulley as standard to meet a wide range of supply air volumes and external static pressures
- › Anti-corrosion treated coil



Indoor unit		UATYQ	250CY1	350CY1	450CY1	550CY1	600CY1	700CY1	250CY1	450CY1		
Cooling capacity	Nom.	kW	27.340	35.580	44.720	55.690	66.820	72.600	27.340	44.720		
Heating capacity	Nom.	kW	24.910	34.790	41.790	53.930	61.690	69.610	24.910	41.790		
Power input	Cooling	Nom.	kW	8.140	10.780	13.040	16.740	19.650	21.610	8.140	13.040	
	Heating	Nom.	kW	7.330	10.840	12.860	15.540	18.580	21.420	7.330	12.860	
EER			3.36	3.30	3.43	3.33	3.40	3.36		3.43		
COP			3.40	3.21	3.25	3.47	3.32	3.25	3.40	3.25		
Evaporator	Air flow rate	Cooling	m ³ /min	93.6	121.8	160.2	189.6	206.7	235.02	93.6	160.2	
	External static pressure		Pa	147			206		147			
Evaporator piping connections	Condensation drain size		OD	25.4								
Condenser	Dimensions	Unit	Height	mm	1,150	1,028	1,130	1,048	1,302	1,454	1,150	1,130
			Width	mm	1,638	2,209				1,638	2,209	
			Depth	mm	2,063	2,113		2,670		2,063	2,113	
Weight	Unit	kg	445	580	610	830	880	1,020	445	610		
Casing	Colour		Light grey									
Air flow rate	Cooling	cfm	8,230	12,000	12,100	12,900	20,200	21,200	8,230	12,100		
Operation range	Cooling	Min.-Max.	°CDB		0~52							
	Heating	Min.-Max.	°CWB		-15~18							
Sound pressure level	Nom.	dBA	68	64	65	68	70		68	65		
Sound power level	Nom.	dBA	82	83		87	90		82	83		
Refrigerant	Type	R-410A										
	Charge	kg	6.1	5.8	7.2	8.7	10.4	11.6	6.1	7.2		
	TCO ₂ eq		12.7	12.1	15	18.2	21.7	24.2	12.7	15		
GWP	2,087.5											
Power supply	Phase/Frequency/Voltage		Hz/V	3~/50/380-415								

(1) All units are being tested and comply to ISO15151. | Sound pressure levels are measured according to JIS B 8616 standard | All performance calculations are strictly according to Eurovent standard

Economiser option

Indoor unit		ECONO	250AY1	350AY1	450AY1	550AY1	600AY1	700AY1		
Dimensions	Packed unit	Height	mm	534						
		Width	mm	1,440	1,430		1,458			
		Depth	mm	1,144	1,124		1,564			
Weight	Unit	kg	51	42	43	53	54	69		
Packing	Weight		kg	152	140	141	165	166	181	
Fan	Air flow rate	Cooling	Nom.	l/s	1,560	2,030	2,670	3,160	3,445	3,917
				cfm	3,300	4,300	5,650	6,700	7,300	8,300
Power supply	Voltage		V	24 DC						
Option for				UATYQ250CY1	UATYQ350CY1	UATYQ450CY1	UATYQ550CY1	UATYQ600CY1	UATYQ700CY1	
Test Standard				ISO 13253						

Rooftop

- › Easy to install 'plug and play' concept plus single installation configuration; no additional piping is required since indoor and outdoor sides are pre-connected
- › Factory pre-charged refrigerant ensures clean and efficient operation
- › Belt driven fan enables air volume and static pressure to be adjusted as required.
- › Flat top unit design allows maximum use of warehouse and container space
- › High efficiency and reliable scroll compressor
- › Anti-corrosion treated coil



Indoor unit		UATYP		850AY1B	10AY1	12AY1		
Cooling capacity	Nom.			kW	78.6	101.110	109.609	
Heating capacity	Nom.			kW	87.78	102.290	126.314	
Power input	Cooling	Nom.			kW	36.10	43.170	48.200
	Heating	Nom.			kW	32.10	41.670	46.800
EER					2.18	2.34	2.27	
COP					2.73	2.45	2.70	
Evaporator	Air flow rate	Cooling			m ³ /min	263.33	312	354
	External static pressure				Pa		294	
Evaporator piping connections	Condensation drain size	OD			mm		25.40	
Condenser	Dimensions	Unit	Height			mm	1,735	1,974
			Width			mm	2,250	2,252
			Depth			mm	2,800	3,180
Weight	Unit			kg	1,350	1,510	1,600	
Casing	Colour					Light grey		
	Material				-	Electro-galvanised mild steel		
Air flow rate	Cooling			cfm	-	20,000		
Operation range	Cooling	Min.-Max.			°CDB	20~46		
	Heating	Min.-Max.			°CWB	-15~20		
Sound power level	Nom.				dB(A)	-		
Refrigerant	Type					R-407C		
	Charge			kg	9.6	13.5 / 20.0	20.0	
				TCO ₂ eq	17	23.9	35.5	
GWP					1,773.9			
Power supply	Phase/Frequency/Voltage			Hz/V	3N~/50/380-415	3~/50/380-415		

(1) All units are being tested and comply to ISO5151. | Sound pressure levels are according to JIS B 8615 standard. Position of the measurement is 1m in front and 1m below the unit. | Designation based on cooling cycle.

Description	INDOOR UNITS						
	FCQHG-F	FCQG-F	FFQ-C	ACQ-D	FDXS-F9	FDBQ-B	FBQ-D
DCC601A51 Centralised controller with cloud connection	✓	✓	✓	-	✓	✓	✓
Wired remote control	BRC1D52 BRC1E52A (3) BRC1E52B (4)	BRC1D52 BRC1E52A (3)(6) BRC1E52B (4)(6)	BRC1D528 BRC1E52A (3)(6) BRC1E52B (4)(6)	ARCWB	BRC1D52 BRC1E52A (3) BRC1E52B (4)	BRC1D52 BRC1E52A (3) BRC1E52B (4)	BRC1D52 BRC1E52A (3) BRC1E52B (4)
BRC2E52C Simplified remote control (with operation mode selector button) (12)	-	-	✓	-	✓	✓	✓
BRC3E52C Simplified remote control (without operation mode selector button) (12)	-	-	✓	-	✓	✓	✓
DCM601A5A Intelligent touch manager	✓	✓	✓	-	✓	✓	✓
Infrared remote control (heat pump)	BRC7FA532F (5)(10)	BRC7FA532F (5)(10)	BRC7EB530W (8)(9)(10) BRC7F530W (8) (9)(10) BRC7F530S (8)(9)(10)	-	BRC4C65	-	BRC4C65
DCS302C51 Centralised remote control (11)	✓	✓	✓	-	-	-	✓
DCS301B51 Unified ON/OFF control (11)	✓	✓	✓	-	-	-	✓
DST301B51 Schedule timer	✓	✓	✓	-	-	-	✓
Adapter for wiring	-	-	-	-	-	-	-
Adapter for wiring (interlock for fresh air intake fan)	-	-	-	-	-	-	KRP1BA59
Adapter for external ON/OFF and monitoring/for electrical appendices (1)	KRP1B57 (5) KRP4A53 (5)	KRP1B57 KRP4A53 (5)	KRP1B57 KRP4A53 (5)	-	KRP4A54	-	KRP4A52 (14) KRP2A51 (14)
Adapter for wiring (hour meter) (1)(7)(14)	EKRP1C11 (5)	EKRP1C11 (5)	EKRP1B2 (13)	-	-	EKRP1B2 (13)	-
DTA112B51 Interface adapter for Sky Air	-	-	-	-	-	-	✓
Installation box for adapter PCB	KRP1H98 (5)(6)	KRP1H98 (5)(6)	KRP1B101 KRP1BA101	-	KRP1BA101	-	KRP1B101 KRP1BA101
NIM03 - R04084124324 Option PCB for group control	-	-	-	✓	-	-	-
Digital input adapter (1)(13)(14)	BRP7A53	BRP7A53	BRP7A53	-	-	BRP7A54	BRP7A51 (13)
EKRP1B2A Options PCB for external electrical heater, humidifier and/or hour meter (7)	-	-	-	-	-	-	✓
Mounting plate for adapter PCB	-	-	-	-	-	-	-
KRCS01-4 Remote sensor	✓	✓	✓	-	✓	-	✓
Remote ON/OFF, forced OFF kit	-	-	-	-	-	-	-
KJB311A Electrical box with earth terminal (3 blocks)	✓	✓	-	-	✓	-	-
KJB212A Electrical box with earth terminal (2 blocks)	✓	✓	-	-	✓	-	-
KJB411A Electrical box with earth terminal	-	-	-	-	-	-	✓

Notes:

- 1) Installation box for adapter PCB is necessary;
- 2) Interface adapter for Sky Air series (DTA112B51) is necessary;
- 3) Including following languages: English, German, French, Italian, Spanish, Dutch, Greek, Russian, Turkish, Portuguese, Polish;
- 4) Including following languages: English, German, Czech, Croatian, Hungarian, Romanian, Slovenian, Bulgarian, Slovak, Serbian, Albanian;
- 5) Option not available in combination with BYCQ140*G;
- 6) Independently controllable flaps function not available in combination with RR and RQ models;
- 7) Electrical heater, humidifier and hour meter are field supply. These parts should not be installed inside the equipment;
- 8) Sensing function is not available;
- 9) Independently controllable flaps function is not available;
- 10) With the infrared remote control, the individual flap control and automatic air volume control cannot be controlled;
- 11) Including following languages: pack 1: English, German, French, Dutch, Spanish, Italian, Portuguese with PC cable EKPCAB3 in combination with the Updater PC software, you can additionally change the language to : language pack 2: English, Bulgarian, Croatian, Czech, Hungarian, Romanian and Slovenian. Language pack 3: English, Greek, Polish, Russian, Serbian, Slovak and Turkish;
- 12) Only possible in combination with simplified remote control BRC2/3E52C;
- 13) These options require mounting plate KRP4A96, maximally 2 optional PCBs can be mounted.
- 14) When installing electrical heaters, an optional PCB for external electric heaters EKRP1B2A is required for each indoor unit.
- 15) This option needs to be installed together with installation box KRP1B101/KRP1BA101.

INDOOR UNITS								
FDQ-C	FDQ-B	ABQ-C	FAQ-C	FHQ-C	AHQ-C	FUQ-C	FNQ-A	FVQ-C
✓	✓	-	✓	✓	-	✓	✓	✓
BRC1D52 BRC1E52A (3) BRC1E52B (4)	BRC1D52 BRC1E52A (3) BRC1E52B (4)	-	BRC1D52 BRC1E52A (3) BRC1E52B (4)	BRC1D52 BRC1E52A (3) BRC1E52B (4)	ARCWB	BRC1D52 BRC1E52A (3) BRC1E52B (4)	BRC1D52 BRC1E52A (3) BRC1E52B (4)	BRC1D52 BRC1E52A (3) BRC1E52B (4)
✓	✓	-	✓	✓	-	✓	✓	✓
✓	✓	-	✓	✓	-	✓	✓	✓
✓	✓	-	✓	✓	-	✓	✓	✓
BRC4C65	BRC4C65	-	BRC7EB518	BRC7G53	-	BRC7C58 (10)	BRC4C65	-
✓	✓	-	✓	✓	-	✓	✓	✓
✓	✓	-	✓	✓	-	✓	✓	✓
✓	✓	-	✓	✓	-	✓	✓	✓
-	-	-	-	-	-	-	KRP1B56	-
KRP1C64 (15)	KRP1B54	-	-	-	-	-	-	-
KRP4A51 (15)	KRP4A51 (15)	-	KRP4A51 (15)	KRP1B54 KRP4A52 (1)	-	KRP4A53	KRP4A54	KRP1B57 KRP4A52 (6)(14)
-	-	-	-	-	-	-	-	-
-	✓	-	-	-	-	-	-	-
-	-	-	KRP4A93 (6)	KRP1D93A	-	KRP1B97	KRP1BA101	KRP4AA95
-	-	✓	-	-	✓	-	-	-
BRP7A54	BRP7A54	-	BRP7A51 (12)	BRP7A52	-	BRP7A53	BRP7A51 (12)	BRP7A52
✓	✓	-	-	-	-	-	-	-
KRP4A96	KRP4A96	-	-	KKSAP50A56 (35-50)	-	-	-	-
✓	✓	-	✓	✓	-	✓	✓	-
EKRORO3	EKRORO	-	-	EKRORO4	-	EKROROS	-	-
-	-	-	✓	✓	-	✓	✓	-
-	-	-	✓	✓	-	✓	✓	-
-	-	-	-	-	-	-	-	-

Description	INDOOR UNITS						
	FCQHG-F	FCQG-F	FFQ-C	ACQ-D	FDBQ-B	FBQ-D	FDQ-C
Replacement long-life filter	KAFP551K160	KAFP551K160	KAFQ441BA60	-	-	-	-
Drain pump kit	Standard	Standard	Standard	Standard	-	Standard	Standard
L-type piping kit (upward direction)	-	-	-	-	-	-	-
Sealing member of air discharge outlet	KDBHQ55B140 (5)	KDBHQ55B140 (5)	BDBHQ44C60	-	-	-	-
Decoration panel for air discharge	-	-	-	-	-	-	-
Decoration panel	BYCQ140D BYCQ140DW BYCQ140DG BYCQ140DGF (3)	BYCQ140D BYCQ140DW BYCQ140DG BYCQ140DGF (3)	BYFQ60B3 BYFQ60C2W1W BYFQ60C2W1S	ADP125A (10)	-	-	BYBS125D (5)
Kit for mounting of decoration panel direct onto unit	-	-	-	-	-	-	EKBYBSD
Fresh air intake kit (direct installation type)	KDDQ55B140-1 (1)(2) + KDDQ55B140-2 (1)(2)	KDDQ55B140-1 (1)(2) + KDDQ55B140-2 (1)(2)	KDDQ44XA60	-	-	-	-
Air discharge adapter for round duct	-	-	-	-	-	KDAP25A56A (35-50 class) KDAP25A71A (60-71 class) KDAP25A140A (100-140 class)	KDAJ25K140A
Panel spacer	-	-	KDBQ44B60	-	-	-	-
Sensor kit (4)	BRYQ140A	BRYQ140A	BRYQ60A2W (3) BRYQ60A2S (3)	-	-	-	-
Noise filter	-	-	-	-	-	-	-

- The BYCQ140DW has white insulations. Be informed that dirt is more visible on white insulation and that it is consequently not advised to install the BYCQ140DW decoration panel in environments
- To be able to control BYCQ140D/W/DG(F), the controller BRCIE is needed and cannot be combined with mini-VRV, multi and split non-inverter outdoor units.

Notes:

- Option not available in combination with BYCQ140D*G*;
- Both parts of the fresh air intake are needed for each unit;
- This option is intended exclusively for usage in fine dust environments (clothing shops). Do not use this option in high humidity and/or greasy environments.;
- Sensor kit not available with RR & RQ units;
- For directly mounting the decoration panel on the unit, decoration panel option EKBYBSD is required.

Description	OUTDOOR UNITS						
	RZQG-L9V1	RZQG-L8Y1	RZQSG-L9V1	RZQSG-L3/L8Y1	RZQ-C	AZQS-B8V1/BY1	
Central drain plug	-	-	-	-	KWC26B280	-	
Refrigerant branch piping	For twin	KHRQ22M20TA (KHRQ58T) (2)	KHRQ22M20TA (KHRQ58T) (2)	KHRQ22M20TA (KHRQ58T) (2)	KHRQ22M20TA (KHRQ58T) (2)	KHRQ22M20TA	-
	For triple	KHRQ127H (KHRQ58T) (2)	KHRQ127H (KHRQ58T) (2)	KHRQ127H (KHRQ58T) (2)	KHRQ127H (KHRQ58T) (2)	KHRQ250H7	-
	For double twin	KHRQ22M20TA (3x) (KHRQ58T) (2)	KHRQ22M20TA (3x) (KHRQ58T) (2)	KHRQ22M20TA (3x) (KHRQ58T) (2)	KHRQ22M20TA (3x) (KHRQ58T) (2)	KHRQ22M20TA (x3)	-
Demand adapter kit	KRP58M51MK	SB.KRP58M51	SB.KRP58M51 (71 class) KRP58M51MK (100-140), SB.KRP58M51 (V1)	SB.KRP58M51 (71 class) KRP58M51MK (Y1), SB.KRP58M51 (V1)	SB.KRP58M51	KRP58M51MK (Y1), SB.KRP58M51 (V1)	
Bottom plate heater (1)	EKBPH140L7	EKBPH140L7	-	-	-	-	

Notes:

- Bottom plate heater is only available for RZQG* models;
- For combination of RZQ(S)G71-140 in combination with FCQG35-71F or FCQHG71F use the refrigerant branch piping mentioned between brackets

INDOOR UNITS							
FDQ-B	ABQ-C	FAQ-C	FHQ-C	AHQ-C	FUQ-C	FNQ-A	FVQ-C
-	-	-	KAFP501A56 (35-50 class) KAFP501A80 (60-71 class) KAFP501A160 (100-125 class)	-	KAFP551K160	-	KAFJ95L160
-	-	K-KDU572EVE	KDU50P60 (35-60 class) KDU50P140 (71-125 class)	-	-	-	-
-	-	-	KHFP5M35 (35 class) KHFP5N63 (50-60 class) KHFP5N160 (71-125 class)	-	-	-	-
-	-	-	-	-	KDBHP49B140	-	-
-	-	-	-	-	KDBTP49B140	-	-
-	-	-	-	-	-	-	-
-	-	-	-	-	-	-	-
-	-	-	KDDQ50A140	-	-	-	-
-	-	-	-	-	-	-	-
-	-	-	-	-	-	-	-
-	-	-	-	-	-	-	-
-	-	KEK26-1A	-	-	-	KEK26-1A	-

Description	ROOFTOPS	
	UATYQ-C	UATYP-AY1(B)
Rooftop controller	●	-
PCB	●	-
EXV	●	-
Gold Fin (NA549)	●	-
Scroll compressor	●	-
Saranet Air Filter	●	-
Side flow	●	-
Convertible	●	-
Filter drier	●	-
High pressure switch	●	-
Low pressure switch	●	-
ECONO-AY1 Economiser	●	-

VRV the solution for the commercial sector

Daikin's VRV technology leads the way in customisation to match individual commercial building requirements in comfort and energy efficiency. Flexible to cover all applications and climate conditions, VRV has the unique products that make the difference for you and your customers.

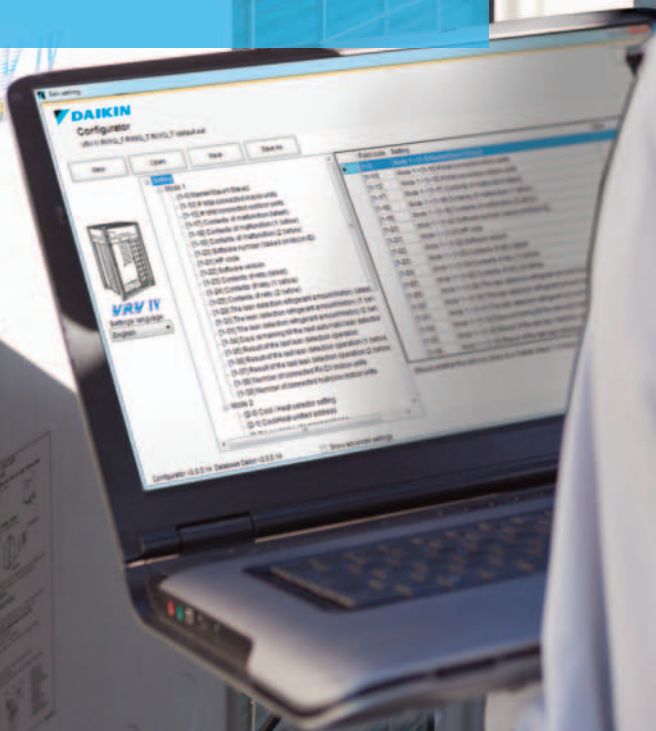

VRV

Medium to large commercial applications

Why choose Daikin VRV?	220	VRV indoor - products overview	258
Total solution concept	228	VRV indoor - benefits overview	258
Application overview	230		
VRV outdoor - products overview	234		
VRV outdoor units			
Heat recovery	236		
REYQ-T	236		
Heat pump	238		
RYYQ-T / RXYQ-T(9)	238		
NEW RXYSCQ-TV1	241		
NEW RXYSQ-TV1/RXYSQ-TY1	242		
NEW SB.RKXYQ-T	245		
RTSYQ-PA	246		
RXYCQ-A	247		
Replacement VRV	250		
RQCEQ-P3	250		
RQYQ-P/RXYQQ-T	251		
Water-cooled VRV	253		
NEW RWEYQ-T8	253		
Branch selector (BS box)	254		
BS1Q-A	254		
BS-Q14AV1	255		
		VRV indoor units	
		Ceiling mounted cassette units	265
		FXFQ-A	265
		FXZQ-A	267
		FXCQ-A	268
		FXKQ-MA	269
		Concealed ceiling units	270
		FXDQ-M9	270
		FXDQ-A	271
		FXSQ-A	272
		FXMQ-P7 / FXMQ-MA	274
		FXTQ-A	276
		Wall mounted unit	277
		FXAQ-P	274
		Ceiling suspended units	278
		FXHQ-A	278
		FXUQ-A	279
		Floor standing units	280
		FXNQ-A	280
		FXLQ-P	281
		Hot water	282
		NEW HXY-A8	282
		NEW HXHD-A8	283
		Accessories for hot water	284
		Options & accessories	286

VRV IV sets the standard ... again



Why choose VRV?

- **Inventor and market leader of VRV systems since 1982**
 - › Over 90 years of expertise in heat pumps
 - › Designed for and produced in Europe
- **Unique outdoor unit range covering all applications and climate conditions**
- **Unique products that make the difference**

in efficiency

- › Variable Refrigerant Temperature leading to the highest seasonal efficiency
- › Round flow cassette with auto cleaning panel
- › Absolute credibility of data with Eurovent certification of air-cooled outdoor units



in comfort

- › Variable Refrigerant Temperature preventing cold draughts
- › True continuous heating, during defrost
- › 15 class units for small, well insulated rooms (cassette, wall, concealed ceiling models)
- › Low sound indoor and outdoor units

in design

- › Fully flat cassette, fully integrated in the ceiling
- › Daikin Emura, unique iconic design

in installation

- › Automatic refrigerant charge and refrigerant containment check
- › 4-way blow ceiling suspended cassette (FXUQ)
- › Plug & play Daikin air handling unit
- › Total solution incl. low and high temperature hydro box, Biddle air curtains, etc.

in control

- › Intelligent Touch manager cost-effective mini BMS integrating all pillars
- › Easy integrating in third party BMS
- › Dedicated control solutions for applications such as technical cooling, shops, hotels, ...

• **Top reliability**

- › True technical cooling
- › Gas-cooled PCB
- › Most extensive testing before new units leave the factory
- › Widest support network and after sales service
- › All spare parts available in Europe

• **The best partner for your green project**

BREEAM[®]

The VRV air conditioning system is the world's first individual air conditioning system with variable refrigerant flow control and was commercialised by Daikin in 1982. VRV is the trademark of Daikin Industries Ltd, which is derived from the technology we call "variable refrigerant volume". BREEAM is a registered trademark of BRE (the Building Research Establishment Ltd. Community Trade Mark E5778551). The BREEAM marks, logos and symbols are the Copyright of BRE and are reproduced by permission

What's new?

• VRV IV S-series

- › Widest range of front blow units in the market
- › Most compact unit in the market (RXYSQC-T)
- › Connect stylish residential or VRV indoor units
- › Total solution incl. air curtains, air handling units, ...
- › Compete reliability thanks to refrigerant cooled PCB

• VRV IV i-series

- › The invisible VRV
- › Unique split outdoor unit concept
- › Easy and quick to transport and install by just 2 persons
- › Total solution incl. air curtains, air handling units, ...

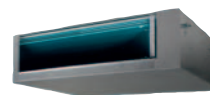

SB.RKXYQ-T



10/12 HP

8 HP

4/5/6 HP

4/5 HP

VRV IV standards

• Variable refrigerant temperature

- › Customize your VRV for best seasonal efficiency & comfort
- › Up to 28% higher seasonal efficiency (ESEER)
- › First weather dependent VRV
- › No more cold draft by supply of high outblow temperatures

• Continuous comfort

- › True/real continuous heating makes VRV IV the best alternative to traditional heating systems

• VRV configurator

- › software for the fastest and most accurate commissioning, configuration and customisation

• Total solution

- › one supplier for heating, cooling, ventilation, hot water, Biddle air curtains and control
- › combine both residential and VRV indoor units

• Free combination of outdoor units to meet installation space or efficiency requirements

• Outdoor unit display for quick on-site settings



Heat pump
Heat recovery
Replacement
Water cooled



Benefits for installers

Daikin VRV IV sets the standard with latest technology and time saving commissioning & servicing

- › Simplified and time saving commissioning with VRV configurator
 - › Remote refrigerant containment check
 - › One supplier = one point of contact
- Many options to meet customer requirements

Benefits for consultants

Daikin's VRV IV technology leads the way in customisation to match individual building requirements in comfort and energy, facilitating reduced capital and running costs

- › Ecological design
- › Ideal for reaching top BREEAM/EPDB levels
- › No more cold draughts with higher evaporation temperatures up to 11 or 16°C, making VRV IV an ideal alternative to water-based systems
- › Unique specification for monovalent heating

Benefits for owners

VRV IV is the ultimate in customised comfort and intelligent control tailored to your individual needs and to maximise energy efficiency

- › Annual cost savings up to 28% (compared with VRV III)
- › No more cold draughts with variable refrigerant temperature
- › Single point of contact for the design and maintenance of your climate control system
- › Integrated system allows maximum energy efficiency for the end user
- › Multiple systems can be managed in exactly the same way for key accounts

VRV IV heat recovery technologies

Improved efficiency

- › In heat recovery operation VRV IV is up to 15% more efficient than VRV III
- › Overall efficiency is increased with up to 28% thanks to Variable Refrigerant Temperature
- › Heat can be re-used to create hot water 'for free'

Maximum comfort

A VRV heat recovery system allows simultaneous cooling and heating.

- › For hotel owners it means a perfect environment for guests as they can freely choose between cooling or heating.
- › For offices it means a perfect working climate both for tenants facing south and north.

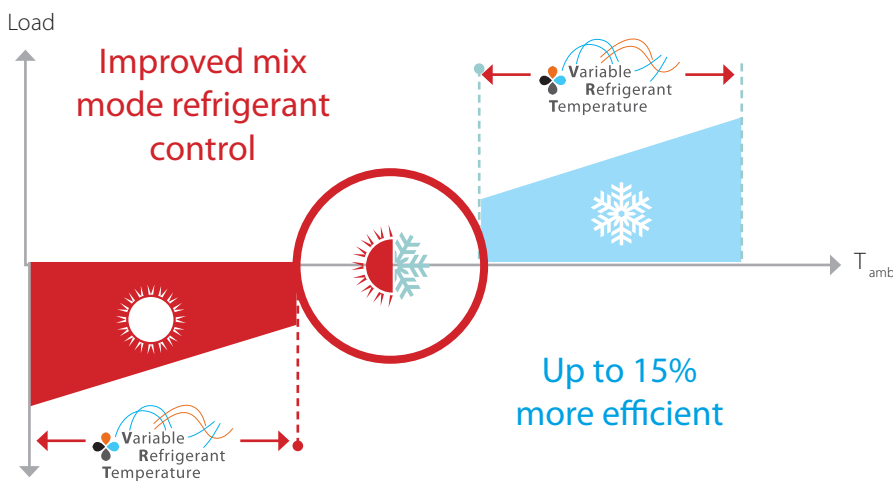

Cooling

Extracted heat



Hot Water



HXY-A



HXHD-A

Advantages of 3-pipe technology

More free heat

Daikin 3-pipe technology needs less energy to recover heat, meaning significant better efficiency during heat recovery mode. Our system can recover the heat at low condensing temperature because it has dedicated gas, liquid and discharge pipes.

In a 2-pipe system gas and liquid travel as a mixture so the condensing temperature needs to be higher in order to separate the mixed gas and liquid refrigerant. The higher condensing temperature means more energy is used to recover heat resulting in lower efficiency.

*only for heat pump series

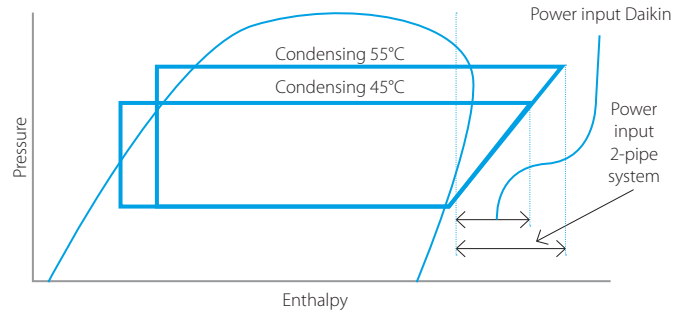

More efficient due to lower pressure drop

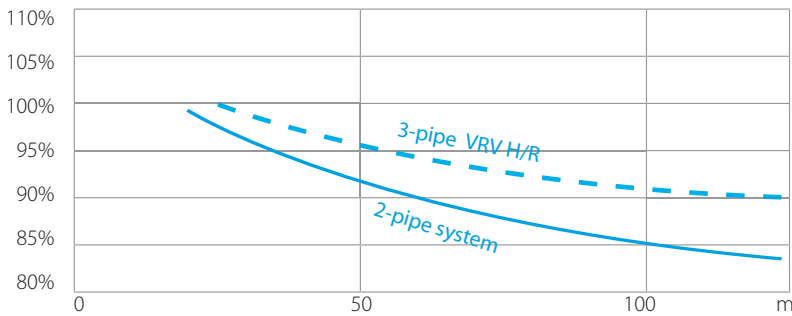

— Smooth refrigerant flow in 3-pipe system thanks to 2 smaller gas pipes leading to higher energy efficiency

— Disturbed refrigerant flow in large gas pipe on 2-pipe system leading to bigger pressure drop

Maximum design flexibility and installation speed

- › Unique range of single and multi BS boxes for flexible and fast design
- › Major reduction in installation time thanks to wide range, compact size and light weight multi BS boxes

Single port



BS1Q10,16,25A

Multi port: 4 – 6 – 8 – 10 – 12 – 16



BS4Q14A

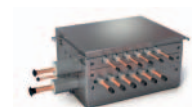

BS6,8Q14A

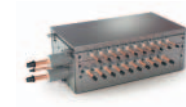

BS10,12Q14A



BS16Q14A

But VRV is more... standard VRV features

Low running costs

- › Precise zone control and inverter technology
- › Up to 50% savings with intelligent sensors and auto cleaning cassette
- › Running costs of a water-based fan coil unit can be 40 to 72% higher compared to a VRV heat recovery system

Great design flexibility

- › Long refrigerant piping
- › Compact units require up to 29% less space than traditional water based systems, offering more lettable space
- › Zone by zone phased installation tailored to the needs of the building
- › Modular approach to better balance different heat load throughout a building
- › Outdoor units can be installed outdoors or indoors
- › Widest range of indoor units to fit customer needs
- › Solutions for every climate, from -25 to +52°C
- › Special VRV S-series designed for small capacities

indoor installation
ESP up to
78pa

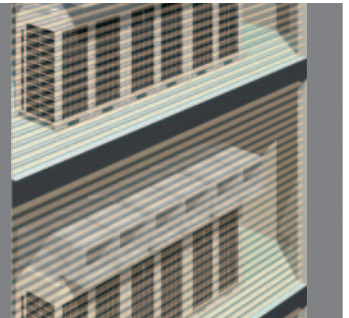

Easy installation and servicing

- › Automatic testing and refrigerant charging
- › Auto addressing of indoor units
- › Easy servicing and F-gas compliance with remote refrigerant containment check
- › Plug & play connection for VRV to Daikin air handling units, the easiest solution with only one point of contact

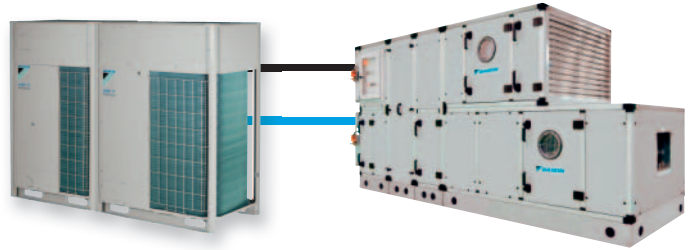

High comfort levels

- › Individual control and simultaneous cooling and heating for perfect personal environment
- › Low indoor sound levels down to 19 dBA
- › Intelligent sensors and high outblow temperatures prevent cold draughts
- › Uniquely designed units: Daikin Emura, Nexura and Fully flat cassette



DAIKIN emura



nexura

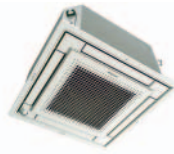

FULLY FLAT CASSETTE

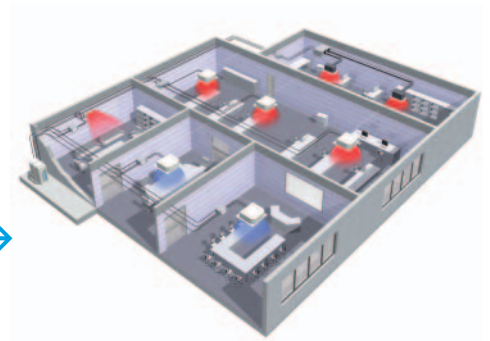

- › CO₂ sensor in combination with Daikin ventilation (VAM, VKM) units ensures fresh air, while preventing energy losses from over-ventilation

Total heat exchanged foul air

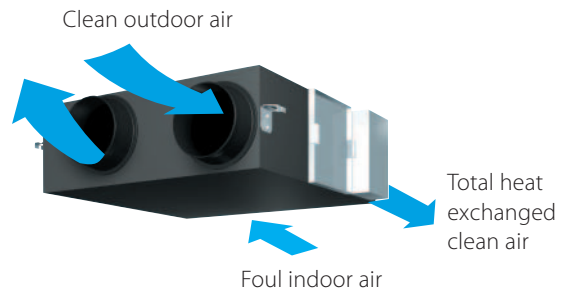

Ease of use

- › Smart energy management optimises the performance automatically 24/7



Ahead of or in line with legislation

- › All indoor units fully eco-design compliant by adopting DC fans (Lot 11)
- › All hydroboxes eco-design compliant by use of efficient pumps (Lot 11)
- › All ventilation units eco-design compliant (Lot 6)
- › VRV air-cooled outdoor units are Eurovent certified, which means absolute credibility of data, as Daikin clearly mentions the outdoor/indoor combinations



Did you know

- › Daikin is the only manufacturer that clearly mentions the outdoor/indoor combinations for which our published data are applicable.
- › Daikin will continue to push Eurovent to select and check not only the outdoor unit for testing, but also the indoor unit types, and make reference to the combination on the Eurovent website.
- › An new line-up of high efficiency ducted indoor units FXTQ50A, FXTQ63A, FXTQ80A and FXTQ100A is launched for connection with VRV IV Heat pump and Heat Recovery only.
- › We keep investing in improving our seasonal efficiency rather than nominal efficiency

Supporting tools

Sales supporting apps

Solutions seasonal simulator, simulate & compare

With this software tool you can simulate and the seasonal efficiency, the annual power consumption and CO₂ emission for a given climate, load profile (cooling, heating, heat recovery, covalent, bivalent...) and combination of systems. With its intuitive and graphical appealing interface, a simulation, comparison and ROI calculation can be made in a matter of minutes.



Xpress, Quick Quotation tool

Xpress is a software tool that allows creating on the spot quotations for a Daikin VRV system. It provides a result in 6 steps to enable a professional budget quotation in the fastest possible way:

- › Select indoor units
- › Connect outdoor units to indoor units
- › Automatic generation of piping diagram with joints
- › Automatic generation of wiring diagram
- › Select possible centralised control systems
- › Visualise result in MS Word, MS Excel and AutoCAD

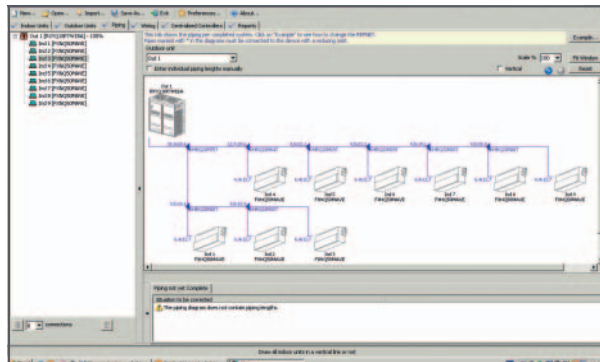

Ventilation Xpress

Selection tool for ventilation devices (VAM, VKM). The selection is based on given supply/extract airflows (including fresh up), and given ESP of the supply/extract ducting:

- › Determines size of electrical heaters
- › Visualization of psychrometric chart
- › Visualization of selected configuration
- › Required field settings mentioned in the report

VRV Pro, Design tool

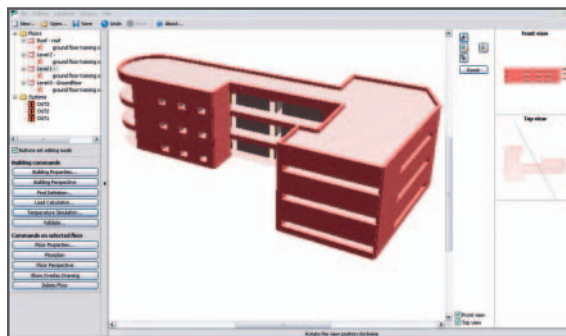
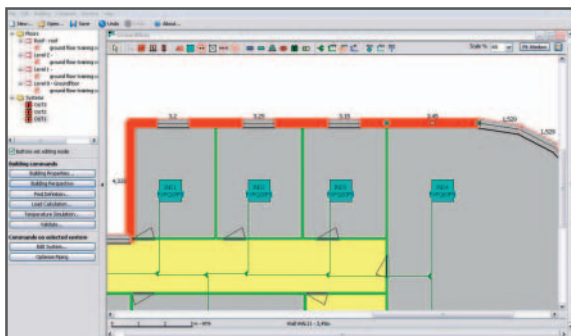

The VRV Pro selection program is a true VRV design tool. The program enables VRV air conditioning systems to be engineered in a precise and economical way, taking into account the realtime thermal properties of any building. By calculating annual energy consumptions, it gives the

designer the possibility to make accurate selections and **get competitive quotations** for each project. Moreover, it ensures optimum operating cycles and maximum energy efficiency.

NEW Building Information Modelling (BIM) support

- › BIM is improving efficiency in the design and built phase
- › Daikin is among the first to supply a full library of BIM objects for it's VRV products
- › Download them at <http://bimobject.com/en-us/product/?freetext=daikin>



Online support

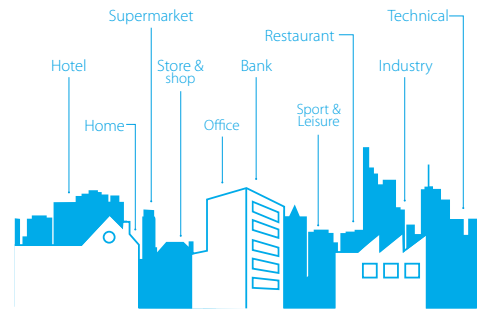

NEW Business portal

- › Experience our new extranet that thinks with you at my.daikin.eu
- › Find information in seconds via a powerful search
- › Customise the options so you see only info relevant for you
- › Access via mobile device or desktop

Internet

- › Find our solution for applications
- › See an overview of our references
- › Get more commercial details on our flagship products

Literature

- › Check the overview of all our literature for our professional network and end-customers

www.daikineurope.com/commercial/applications



www.daikineurope.com/references

www.daikineurope.com/support-and-manuals/catalogues

for professional network

Solution guides:

Hotel Solutions
Clear installer benefits why to choose Daikin for a hotel

15-217

Hotel Solutions
Clear installer benefits why to choose Daikin for a hotel

15-217

Reference books:



Reference catalogue
Daikin commercial and industrial references

14-213

for your customers

Commercial Solutions
Daikin offers solutions for commercial applications

15-100

Green Building Solutions
Clear building owner/investor benefits why to choose Daikin for a green building, with emphasis on BREEAM

15-216

Hotel Solutions
Clear building owner/investor benefits why to choose Daikin for a hotel

15-218

Product profiles:

VRV IV range
Detailed VRV IV standards and technologies benefits. Main features and specs of VRV IV product range

15-206

Rooftop UATYQ-CY1
Detailed rooftop benefits incl. UATYQ-CY1, ECONO-AY1

15-120

Intelligent Touch Manager
Detailed benefits of Intelligent Touch Manager

15-302

Focus topics:

Replacement Technology
Clear installer benefits of VRV replacement technology

15-214

Technical cooling
Clear installer benefits why to choose Daikin for technical cooling

15-140

Replacement technology
Clear building owner/investor benefits of replacement technology

15-215

Product flyers:

Wired Remote Control
Detailed info on BRC1E-52A/B remote control

15-306

RTD modbus interface
Detailed info on RTD controls and applications

15-308

Sky Air product leaflets
Single page leaflet with the main benefits and technical specifications of each individual Sky Air unit. Ideal for quotations

VRV product leaflets
Single page leaflet with the main benefits and technical specifications of each individual VRV unit. Ideal for quotations

Product catalogues:

Sky Air Catalogue
Detailed technical information & benefits on Sky Air/Ventilation/Biddle Air Curtain/Control systems/AHU

15-114

VRV Catalogue
Detailed technical information & benefits of the VRV total solution

15-200

Ventilation Catalogue
Detailed info on Ventilation products

15-203

Product portfolios:

Sky Air product portfolio
Overview of Sky air product range

15-121

VRV product portfolio
Overview of VRV total solution product range

15-201

Controls systems portfolio
Overview of all Daikin control systems

15-301



Technical documentation:

Download all technical documentation such as engineering data-books, selection software, installation and operation manuals and service manuals directly from our extranet: extranet.daikineurope.com

The total solution



Typically, many buildings today rely on several separate systems for heating, cooling, air curtain heating and hot water. As a result energy is wasted. To provide a much more efficient alternative, VRV technology has been developed into a total solution managing up to 70% of a buildings energy consumption giving large potential to cost saving.

- › **Heating and cooling** for year round comfort
- › **Hot water** for efficient production of hot water
- › **Underfloor heating /cooling** for efficient space heating/cooling
- › **Ventilation** for high quality environments
- › **Air curtains** for optimum air separation
- › **Controls** for maximum operating efficiency

Combine up to 70% of your building's energy consumption

Average hotel energy consumption

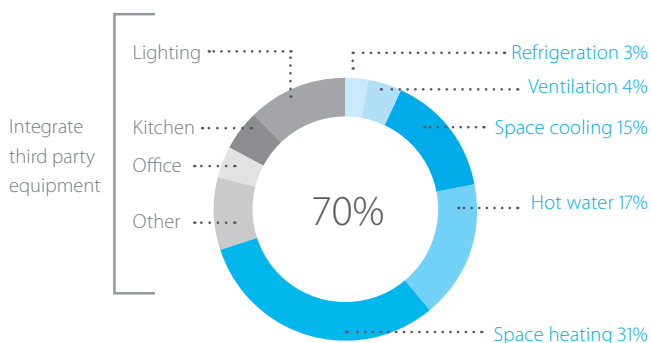

Average office energy consumption

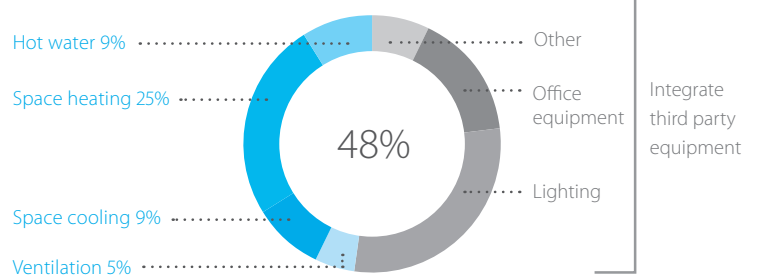

One system, multiple applications for hotels, offices, retail, home ...

Heating and cooling



- › Combine VRV indoor units with other stylish indoor units in one system
- › New round flow cassette sets the standard for efficiency and comfort

Intelligent control systems



- › Mini BMS with connects Daikin and third-party equipment
- › Integrate intelligent control solutions with energy management tools to reduce running costs

Low-temperature hydrobox



- › Highly efficient space heating through:
 - Underfloor heating
 - Low temperature radiators
 - Heat pump convectors
- › Hot water from 25 °C to 45 °C

Biddle air curtain

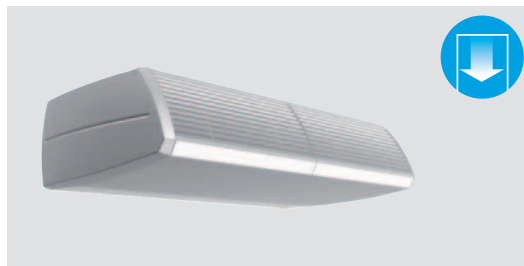

- › Payback time less than 1 year compared to electrical air curtain
- › A highly efficient solution for doorway climate separation

High temperature hydrobox*



*only for connection to VRV heat recovery

- › efficient hot water production for:
 - Showers
 - Sinks
 - Tapwater for cleaning
- › Hot water from 25 °C to 80 °C

Ventilation



- › Widest range in DX ventilation – from small heat recovery ventilation to large scale air handling units
- › Provides a fresh, healthy and comfortable environment



VRV for offices and banks

Efficiency in the workplace

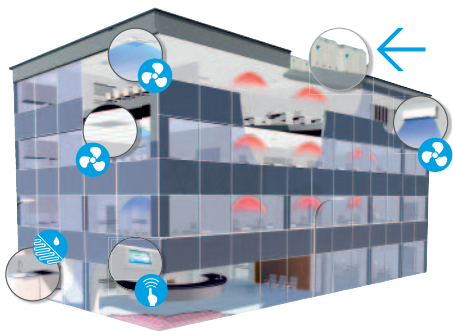

Efficient building and facilities management are key to minimising operational costs

Our office solution offers:

- › Significantly reduced costs for hot water and heating by re-using heat recovered from areas requiring cooling
- › Unique fully flat cassette integrating fully flat into architectural ceilings
- › Intelligent sensors
 - maximise efficiency by switching of the unit if there is nobody in the meeting room
 - maximise comfort by directing the air flow from people to avoid cold draught
- › Complete Daikin mini BMS for office building management with Intelligent Touch Manager
- › Plug & play connection to air handling units for a healthier office atmosphere
- › Hot water production for sinks and underfloor heating
- › True reliable technical cooling down to -20°C, including duty/standby function



Check on
You Tube

[www.youtube.com/
DaikinEurope](http://www.youtube.com/DaikinEurope)



VRV for hotels

Hospitality with economy



A hotel's reputation depends on how welcome and comfortable guests feel during their stay. Yet at the same time, hotel owners must maintain complete control of their operating costs and energy consumption.

Our hotel solution offers:

- › Low cost heating and hot water by recovering heat from areas requiring cooling
- › The perfect personal environment for guests by simultaneously heating spaces while cooling others
- › Flexible installation: the outdoor unit can be installed outdoors to maximise hospitality space or indoors to minimise external space or noise in city centres
- › Concealed ceiling units developed for small, well-insulated rooms such as hotel bedrooms, offering very low sound levels ensuring a good's night rest
- › Smart energy management via Intelligent Touch Manager puts the hotel owner in full control of energy costs
- › Intelligent and user-friendly hotel room controllers change the set point automatically when a guest leaves the room or opens the window
- › Easy integration in hotel booking software
- › Hot water production for bathrooms, underfloor heating and radiators up to 80°C

Check on
You Tube

[www.youtube.com/
DaikinEurope](http://www.youtube.com/DaikinEurope)

Hotel



Bank / Retail





VRV for retail

Reducing retail costs



Retailers are under pressure to reduce both store development costs and running costs. That is why affordable, energy-efficient solutions are vital for minimising lifetime costs, while ensuring compliance with the latest regulations.

Our retail solutions offer:

- › Compact inverter heat pump technology
- › Flexible installation: the outdoor unit can be installed outdoors to maximise hospitality space or indoors to minimise external space or noise in city centres
- › Unique round flow cassettes with autocleaning panel saving up to 50% of energy use compared to standard cassette units
- › Easy to use remote control with lock-key function to avoid improper use
- › Individual control of each indoor unit or shop zone
- › Savings on running cost via pre/post trade modes, limiting energy use by lights, air conditioning, ...
- › The most efficient open-door solution with Biddle air curtains

Upgrade R-22 and R-407C systems quick and qualitatively with...

VRV Replacement solutions:

VRV for residential use

There is no place like home

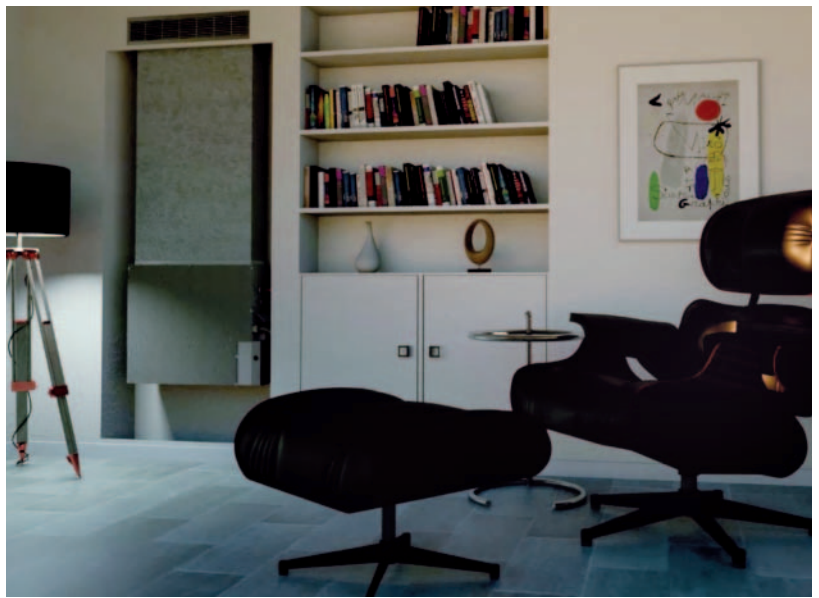

A cost effective, low energy consumption heat pump system for home owners, offering maximum comfort

Our residential solution offers:

- › Lower CO₂ emissions compared to traditional heating systems
- › Compact outdoor unit design with a low sound level
- › Whisper-quiet indoor units down to 19dBA
- › Daikin Emura, iconic design wall mounted unit
- › Unique Nexura floor standing unit offering the feel of a radiator with the efficiency of a heat pump
- › Units to be concealed in the wall or ceiling to make them completely unnoticed
- › User-friendly, intuitive control
- › Up to 9 indoor units that can be connected to one outdoor unit

- › Keep your customers operational even during system replacement
- › Less installation time
- › Lower installation costs
- › Replace non-Daikin systems
- › Automatic refrigerant charge and pipe cleaning

Check on
You Tube

www.youtube.com/DaikinEurope





EIFFAGE ENERGIE ET EIFFAGE ENERGIE THERMIE
OFFICE BUILDING
VRV IV HEAT PUMP WITH CONTINUOUS HEATING



PARK PHI
BREAM EXCELLENT OFFICE BUILDING
WATERCOOLED VRV



VRV IV i-SERIES VRV IV HEAT PUMP
FOR INDOOR INSTALLATION

HOTEL LE PIGONNET, 8 REPLACEMENT VRV













VRV IV S-SERIES



CINEMEERSE, CINEMA, 12 OUTDOOR UNITS WITH AHU

Products overview **VRV**

Model	Product name	4	5	6	8	10	12	13	14	16	18	20	22	24	26	28	30			
Air cooled - heat recovery	<p>Best efficiency & comfort solution</p> <ul style="list-style-type: none"> Fully integrated solution with heat recovery for maximum efficiency Covers all thermal needs of a building via a single point of contact: accurate temperature control, ventilation, hot water, air handling units and Biddle air curtains "Free" heating and hot water through heat recovery The perfect personal comfort for guests/tenants via simultaneous cooling and heating Incorporates VRV IV standards & technologies such as Variable Refrigerant temperature and continuous heating Allows technical cooling Widest range of BS boxes on the market 	REYQ-T VRV IV					●	●	●	●	●	●	●							
	<p>Daikin's optimum solution with top comfort</p> <ul style="list-style-type: none"> Continuous heating during defrost Covers all thermal needs of a building via a single point of contact: accurate temperature control, ventilation, hot water, air handling units and Biddle air curtains Connectable to stylish indoor units (Daikin Emura, Nexura) Incorporates VRV IV standards & technologies such as Variable Refrigerant temperature and continuous heating 	RYYQ-T VRV IV					●	●	●	●	●	●	●							
	<p>Daikin's solution for comfort & low energy consumption</p> <ul style="list-style-type: none"> Covers all thermal needs of a building via a single point of contact: accurate temperature control, ventilation, hot water, air handling units and Biddle air curtains Connectable to stylish indoor units (Daikin Emura, Nexura) Incorporates VRV IV standards & technologies such as Variable Refrigerant temperature 	RXYQ-T(9) VRV IV					●	●	●	●	●	●	●							
Air cooled - heat pump	<p>NEW The most compact VRV</p> <ul style="list-style-type: none"> Compact and lightweight single fan design saves space and is easy to install Covers all thermal needs of a building via a single point of contact: accurate temperature control, ventilation, air handling units and Biddle air curtains Either connect VRV of stylish indoor units (Daikin Emura, Nexura) Incorporates VRV IV standards & technologies such as Variable Refrigerant temperature 	RXYSQ-TV1 VRV IV S-series Compact		●	●															
	<p>NEW Space saving solution without compromising on efficiency</p> <ul style="list-style-type: none"> Space saving trunk design for flexible installation Covers all thermal needs of a building via a single point of contact: accurate temperature control, ventilation, air handling units and Biddle air curtains Either connect VRV of stylish indoor units (Daikin Emura, Nexura) Incorporates VRV IV standards & technologies such as Variable Refrigerant temperature 	RXYSQ-TV1/TY1 VRV IV S-series		TV1	●	●	●													
				TY1	●	●	●	●	●											
VRV III heat pump, optimised for heating	<p>NEW The invisible VRV</p> <ul style="list-style-type: none"> Unique VRV heat pump for indoor installation Total flexibility for any shop location and building type as the outdoor unit is invisible and split up in 2 parts Incorporates VRV IV standards & technologies such as Variable Refrigerant temperature Covers all thermal needs of a building via a single point of contact: accurate temperature control, ventilation and Biddle air curtains 	SB.RKXYQ-T* VRV IV i-series																		
	<p>Where heating is priority without compromising on efficiency</p> <ul style="list-style-type: none"> Suitable for single source heating Extended operation range down to -25°C in heating Stable heating capacity and high efficiencies at low ambient temperatures 	RTSYQ-PA VRV III-C																		
	<p>Classic VRV configuration</p> <ul style="list-style-type: none"> For standard cooling & heating requirements Connectable to VRV indoor units, controls and ventilation 	RXYCQ-A VRV Classic																		
Replacement	<p>Quick & quality replacement for R-22 and R-407C systems</p> <ul style="list-style-type: none"> Cost-effective and fast replacement through re-use of existing piping Drastically improve your comfort, efficiency and reliability No interruption of daily business while replacing your system Replace Daikin and other manufacturers systems safely 	RQCEQ-P* VRV III-Q																		
	<p>Quick & quality replacement for R-22 and R-407C systems</p> <ul style="list-style-type: none"> Cost-effective and fast replacement through re-use of existing piping Drastically improve your comfort, efficiency and reliability No interruption of daily business while replacing your system Replace Daikin and other manufacturers systems safely Incorporates VRV IV standards & technologies such as Variable Refrigerant temperature 	RXYQ-Q-T* VRV IV Q-series			●	●	●	●	●	●	●	●	●							
Water cooled	<p>Ideal for high rise buildings, using water as heat source</p> <ul style="list-style-type: none"> Reduced CO₂ emissions thanks to the use of geothermal energy as a renewable energy source No need for an external heating or cooling source when used in geothermal mode Covers all thermal needs of a building via a single point of contact: accurate temperature control, ventilation, air handling units and Biddle air curtains Compact & lightweight design can be stacked for maximum space saving Incorporates VRV IV standards & technologies such as Variable Refrigerant temperature Variable Water Flow control option increases flexibility and control 	RWEYQ-T8* VRV IV W-series																		

Capacity (HP)

32	34	36	38	40	42	44	46	48	50	52	54	Description / Combination	VRV indoor units	Residential indoor units	LT Hydrobox HXY-A	HT Hydrobox HXHD-A	HRV units VAM-, VKM-	AHU connection EKE XV + EKEQMCBA	AHU connection EKE XV + EKEQFCBA	Air curtains CYV-DK-	Remarks
												VRV IV Heat Recovery REYQ-T	○	×	○	○	○	○	×	○	› Standard total system connection ratio limit: 50 ~ 130%
												with only VRV indoor units	✓								
												with LT/HT Hydroboxes	✓	✓	✓	✓					› Max 32 indoor units, even on 16HP and larger systems › Total system connection ratio up to 200% possible
												HRV units VAM-, VKM-	✓	✓	✓	✓	✓		✓		
●	●	●	●	●	●	●	●	●	●	●	●	AHU connection EKE XV + EKEQMCBA	✓				✓	✓		✓	› Dedicated systems (with only ventilation units) not allowed – a mix with standard VRV indoor units is always necessary
												Biddle air curtain CYV-DK-	✓				✓	✓		✓	
												VRV IV Heat Pump RYYQ-T / RXYQ-T(9)	○	○	○	×	○	○	○	○	› Standard total system connection ratio limit: 50 ~ 130%
												with only VRV indoor units	✓								› 200% total system connection ratio possible under special circumstances
●	●	●	●	●	●	●	●	●	●	●	●	with residential indoor units	✓	✓			✓				› Only single-module systems (RYYQ 8~20 T / RXYQ 8~20 T) › Max 32 indoor units, even on 16HP, 18HP and 20HP systems
												with LT Hydroboxes	✓	✓		✓					› Max 32 indoor units, even on 16HP and larger systems › Contact Daikin in case of multi-module systems (>20HP)
												HRV units VAM-, VKM-	✓	✓	✓	✓	✓		✓		
												AHU connection EKE XV + EKEQMCBA	✓				✓	✓		✓	
●	●	●	●	●	●	●	●	●	●	●	●	AHU connection EKE XV + EKEQFCBA							✓		
												Biddle air curtain CYV-DK-	✓				✓	✓		✓	
												VRV IV-S RXYSCQ-/RXYSCQ-	○	○	×	×	○	○	×	○	› Standard total system connection ratio limit: 50 ~ 130%
												with VRV indoor units only	✓				✓	✓		✓	
												with Split indoor units only		✓							
												VRV IV i series SB.RKXYQ-T	✓	×	×	×	✓	✓	×	✓	› Standard total system connection ratio limit: 50 ~ 130%
												VRV III Cold Region RTSYQ-PA	✓	×	×	×	✓	✓	×	✓	› Standard total system connection ratio limit: 50 ~ 130%
												VRV Classic RXYCQ-A	✓	×	×	×	✓	×	×	×	› Standard total system connection ratio limit: 50 ~ 120% › In case of using at least one FXFQ20~25 indoor units on 8HP or 10HP models, the maximum connection ratio is 100%.
												VRV III-Q Replacement H/R RQCEQ-P	✓	×	×	×	✓	×	×	×	› Standard total system connection ratio limit: 50 ~ 130%
●	●	●	●	●	●							VRV IV-Q Replacement H/P RXYQ-Q-T	✓	×	×	×	✓	✓	×	✓	› Standard total system connection ratio limit: 50 ~ 130%
												VRV IV-W Water-cooled VRV RWEYQ-T	✓	×	×	×	✓	✓	×	✓	› Standard total system connection ratio limit: 50 ~ 130%

○ ... connection of indoor unit possible, but not necessarily simultaneously with other allowed indoor units

✓ ... connection of indoor unit possible even simultaneously with other checked units in the same row

× ... connection of indoor not possible on this outdoor unit system

VRV IV heat recovery

Best efficiency & comfort solution

- › Fully integrated solution with heat recovery for maximum efficiency with COPs of up to 8 !
- › Covers all thermal needs of a building via a single point of contact: accurate temperature control, ventilation, hot water, air handling units and Biddle air curtains
- › „Free“ heating and hot water production provided by transferring heat from areas requiring cooling to areas requiring heating or hot water
- › The perfect personal comfort for guests/tenants via simultaneous cooling and heating
- › Incorporates VRV IV standards & technologies: Variable Refrigerant Temperature, continuous heating, VRV configurator, 7 segment display and full inverter compressors, 4-side heat exchanger, refrigerant cooled PCB, new DC fan motor
- › Free combination of outdoor units to meet installation space or efficiency requirements
- › Possibility to extend the operation range in cooling down to -20°C for technical cooling operation such as server rooms
- › Contains all standard VRV features

Outdoor system		REYQ	8T	10T	12T	14T	16T	18T	20T				
Capacity range		HP	8	10	12	14	16	18	20				
Cooling capacity	Nom.	kW	22.4 (1) / 22.4 (2)	28.0 (1) / 28.0 (2)	33.5 (1) / 33.5 (2)	40.0 (1) / 40.0 (2)	45.0 (1) / 45.0 (2)	50.4 (1)	56.0 (1)				
Heating capacity	Nom.	kW	22.4 (3) / 22.40 (4)	28.0 (3) / 28.00 (4)	33.5 (3) / 33.5 (4)	40.0 (3) / 40.00 (4)	45.0 (3) / 45.00 (4)	50.4 (3)	56.0 (3)				
	Max.	kW	25.0 (3)	31.5 (3)	37.5 (3)	45.0 (3)	50.0 (3)	56.5 (3)	63.0 (3)				
Power input - 50Hz	Cooling	Nom.	kW	5.31 (1) / 4.56 (2)	7.15 (1) / 6.19 (2)	9.23 (1) / 8.31 (2)	10.7 (1) / 9.61 (2)	12.8 (1) / 11.9 (2)	15.2	18.6			
		Nom.	kW	4.75 (3) / 4.47 (4)	6.29 (3) / 5.47 (4)	8.05 (3) / 6.83 (4)	9.60 (3) / 9.37 (4)	11.2 (3) / 9.88 (4)	12.3 (3)	14.9 (3)			
	Max.	kW	5.51 (3)	7.38 (3)	9.43 (3)	11.3 (3)	12.9 (3)	14.3	17.5				
EER		kW	4.22 (1) / 4.92 (2)	3.92 (1) / 4.52 (2)	3.63 (1) / 4.03 (2)	3.74 (1) / 4.16 (2)	3.52 (1) / 3.79 (2)	3.32	3.01				
ESEER - Automatic			7.41	7.37	6.84	7.05	6.63	6.26	5.68				
ESEER - Standard			6.25	5.78	5.36	5.45	5.14	4.84	4.39				
COP at nominal capacity		kW	4.72 (3) / 5.01 (4)	4.45 (3) / 5.12 (4)	4.16 (3) / 4.90 (4)	4.17 (3) / 4.27 (4)	4.02 (3) / 4.56 (4)	4.10 (3)	3.76 (3)				
COP at maximum capacity		kW	4.54 (3)	4.27 (3)	3.98 (3)	3.88 (3)	3.95	3.60					
Maximum number of connectable indoor units			64 (5)										
Indoor index connection	Min.		100	125	150	175	200	225	250				
	Nom.		200	250	300	350	400	450	500				
	Max.		260	325	390	455	520	585	650				
Dimensions	Unit	HeightxWidthxDepth	mm			1,685x930x765			1,685x1,240x765				
Weight	Unit		kg		210	218	304	305	337				
Fan	Air flow rate	Cooling	Nom.	m ³ /min	162	175	185	223	260	251	261		
					78	79	81	86	88				
Sound power level	Cooling	Nom.	dB(A)	58	58	61	64	65	66				
Sound pressure level	Cooling	Nom.	dB(A)										
Operation range	Cooling	Min.~Max.	°CDB		-5.0~43.0								
		Min.~Max.	°CWB		-20~-15.5 (6)								
Refrigerant	Type		R-410A										
	Charge	kg	9.7	9.8	9.9	11.8							
		TCO ₂ eq	20.2	20.5	20.7	24.6							
Piping connections	Liquid	OD	mm			9.52			12.7			15.9	
		Gas	OD	mm	19.1	22.2	28.6						
	Discharge gas	OD	mm	15.9	19.1		22.2			28.6			
			Total piping length	System	Actual	m							
Power supply	Phase/Frequency/Voltage	Hz/V	3N~/50/380-415										
Current - 50Hz	Maximum fuse amps (MFA)	A	20	25		32	40		50				

Outdoor system		REYQ	10T	13T	16T	18T	20T	22T	24T	26T	28T	30T	32T	
System	Outdoor unit module 1		REMQ5T		REYQ8T		REYQ10T	REYQ8T	REYQ12T		REYQ16T			
	Outdoor unit module 2		REMQ5T	REYQ8T	REYQ10T	REYQ12T	REYQ16T	REYQ14T	REYQ16T	REYQ18T	REYQ16T			
Capacity range		HP	10	13	16	18	20	22	24	26	28	30	32	
Cooling capacity	Nom.	kW	28.0	36.4	44.8	50.4	55.9	61.5	67.4	73.5	78.5	83.9	90.0	
Heating capacity	Nom.	kW	28.0	36.4	44.8	50.4	55.9	61.5	67.4	73.5	78.5	83.9	90.0	
	Max.	kW	32.0	41.0	50.0	56.5	62.5	69.0	75.0	82.5	87.5	94.0	100.0	
Power input - 50Hz	Cooling	Nom.	kW	6.34	8.48	10.62	12.46	14.54	16.38	18.11	19.93	22.03	24.43	25.6
		Nom.	kW	5.42	7.46	9.50	11.04	12.80	14.34	15.95	17.65	19.25	20.35	22.4
	Max.	kW	6.50	8.76	11.02	12.89	14.94	16.81	18.41	20.73	22.33	23.73	25.8	
EER		kW	4.42	4.29	4.22	4.04	3.84	3.75	3.72	3.69	3.56	3.43	3.52	
ESEER - Automatic			7.77	7.54	7.41	7.38	7.06	7.07	6.87	6.95	6.72	6.48	6.63	
ESEER - Standard			6.55	6.36	6.25	5.98	5.68	5.54	5.46	5.41	5.23	5.03	5.14	
COP at nominal capacity		kW	5.17	4.88	4.72	4.57	4.37	4.29	4.23	4.16	4.08	4.12	4.02	
COP at maximum capacity		kW	4.92	4.68	4.54	4.38	4.18	4.10	4.07	3.98	3.92	3.96	3.88	
Maximum number of connectable indoor units			64 (5)											
Indoor index connection	Min.		125	162.5	200	225	250	275	300	325	350	375	400	
	Nom.		250	325.0	400	450	500	550	600	650	700	750	800	
	Max.		325	422.5	520	585	650	715	780	845	910	975	1,040	
Piping connections	Liquid	OD	mm	9.52	12.7		15.9			19.1				
				Gas	OD	mm	22.2	28.6				34.9		
	Discharge gas	OD	mm	19.1		22.2		28.6						
				Total piping length	System	Actual	m							
Current - 50Hz	Maximum fuse amps (MFA)	A	40				50	63					80	
Continuous heating			v											

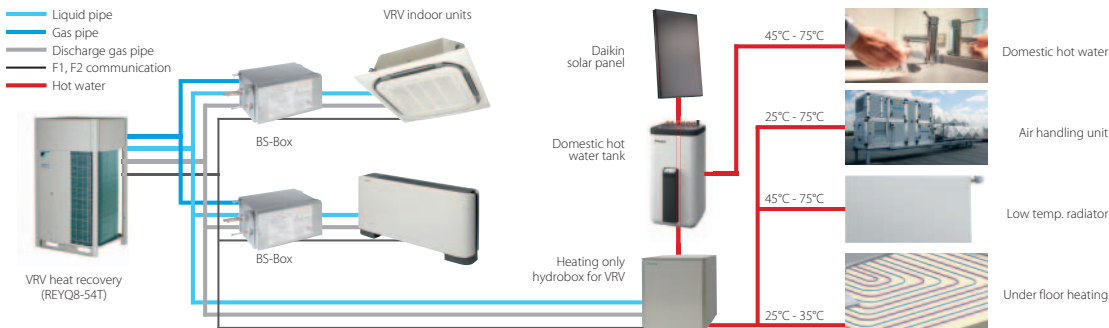
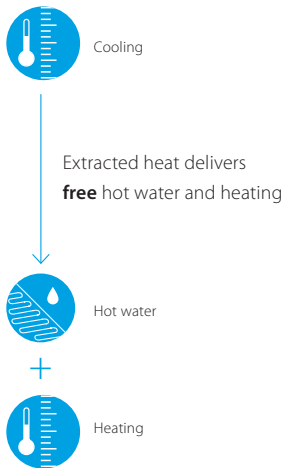

Outdoor system			REYQ	34T	36T	38T	40T	42T	44T	46T	48T	50T	52T	54T	
System	Outdoor unit module 1		REYQ16T	REYQ8T	REYQ10T	REYQ12T	REYQ14T	REYQ16T		REYQ16T		REYQ18T		REYQ18T	
	Outdoor unit module 2		REYQ18T	REYQ20T	REYQ12T	REYQ16T		REYQ16T		REYQ16T		REYQ18T		REYQ18T	
	Outdoor unit module 3		-		REYQ18T	REYQ16T		REYQ16T		REYQ16T		REYQ18T		REYQ18T	
Capacity range		HP	34	36	38	40	42	44	46	48	50	52	54		
Cooling capacity	Nom.	kW	95.4	101.0	106.3	111.9	118.0	123.5	130.0	135.0	140.4	145.8	151.2		
Heating capacity	Nom.	kW	95.4	101.0	106.3	111.9	118.0	123.5	130.0	135.0	140.4	145.8	151.2		
	Max.	kW	106.5	113.0	119.0	125.5	131.5	137.5	145.0	150.0	156.5	163.0	169.5		
Power input - 50Hz	Cooling	Nom.	kW	28.0	31.4	29.74	31.58	32.75	34.83	36.3	38.4	40.8	43.2	45.6	
	Heating	Nom.	kW	23.5	26.1	25.10	26.64	28.69	30.45	32.00	33.6	34.7	35.8	36.9	
		Max.	kW	27.2	30.4	29.24	31.11	33.18	35.23	37.1	38.7	40.1	41.5	42.9	
EER		kW	3.41	3.22	3.57	3.54	3.60	3.55	3.58	3.52	3.44	3.38	3.32		
ESEER - Automatic			6.43	6.06	6.66	6.68	6.79	6.68	6.75	6.63	6.49	6.37	6.26		
ESEER - Standard			4.97	4.70	5.25	5.20	5.28	5.20	5.23	5.14	5.03	4.93	4.84		
COP at nominal capacity		kW	4.06	3.87	4.24	4.20	4.11	4.06		4.02	4.05	4.07	4.10		
COP at maximum capacity		kW	3.92	3.72	4.07	4.03	3.96	3.90	3.91	3.88	3.90	3.93	3.95		
Maximum number of connectable indoor units			64 (5)												
Indoor index connection	Min.		425	450	475	500	525	550	575	600	625	650	675		
	Nom.		850	900	950	1,000	1,050	1,100	1,150	1,200	1,250	1,300	1,350		
	Max.		1,105	1,170	1,235	1,300	1,365	1,430	1,495	1,560	1,625	1,690	1,755		
Piping connections	Liquid	OD							19.1						
	Gas	OD							41.3						
	Discharge gas	OD	28.6						34.9						
	Total piping length	System	Actual							1,000					
Current - 50Hz	Maximum fuse amps (MFA)	A	80				100				125				
Continuous heating			v												
Outdoor unit module			REM-Q			5T									
Dimensions	Unit	Height/Width/Depth							1,685/930/765						
Weight	Unit								210						
Fan	Air flow rate	Cooling	Nom.							162					
Sound power level	Cooling		Nom.							77					
Sound pressure level	Cooling		Nom.							56					
Operation range	Cooling	Min.~Max.							-5.0~43.0						
	Heating	Min.~Max.							-20~-15.5						
Refrigerant	Type		R-410A												
	Charge	kg	9.7												
		TCO ₂ eq	20.2												
	GWP		2,087.5												
Power supply	Phase/Frequency/Voltage	Hz/V	3N~/50/380-415												
Current - 50Hz	Maximum fuse amps (MFA)	A	20												

(1) Nominal cooling capacities are based on: indoor temperature: 27°CDB, 19°CWB, outdoor temperature: 35°CDB, equivalent refrigerant piping: 5m, level difference: 0m. Data for standard efficiency series (2) Nominal cooling capacities are based on: indoor temperature: 27°CDB, 19°CWB, outdoor temperature: 35°CDB, equivalent refrigerant piping: 5m, level difference: 0m. Data for high efficiency series, Eurovent certified (3) Nominal heating capacities are based on: indoor temperature: 20°CDB, outdoor temperature: 7°CDB, 6°CWB, equivalent refrigerant piping: 5m, level difference: 0m. Data for standard efficiency series (4) Nominal heating capacities are based on: indoor temperature: 20°CDB, outdoor temperature: 7°CDB, 6°CWB, equivalent refrigerant piping: 5m, level difference: 0m. Data for high efficiency series, Eurovent certified (5) Actual number of connectable indoor units depends on the indoor unit type (VRV indoor, Hydrobox, RA indoor, etc.) and the connection ratio restriction for the system (50% ≤ CR ≤ 130%) (6) Technical cooling setting, refer to the installation manual for more information | Contains fluorinated greenhouse gases

VRV IV heat pump

Daikin's optimum solution with top comfort

- › Covers all thermal needs of a building via a single point of contact: accurate temperature control, ventilation, hot water, air handling units and Biddle air curtains
- › Wide range of indoor units: possibility to combine VRV with stylish indoor units (Daikin Emura, Nexura, ...)
- › Incorporates VRV IV standards & technologies: Variable Refrigerant Temperature, continuous heating, VRV configurator, 7 segment display and full inverter compressors, 4-side heat exchanger, refrigerant cooled PCB, new DC fan motor
- › Free combination of outdoor units to meet installation space or efficiency requirements
- › Available as heating only by irreversible field setting
- › Contains all standard VRV features

Outdoor unit		RYYQ/RXYQ	8T/8T9	10T	12T	14T	16T	18T	20T		
Capacity range		HP	8	10	12	14	16	18	20		
Cooling capacity	Nom.	kW	22.4 (1) / 22.4 (2)	28.0 (1) / 28.0 (2)	33.5 (1) / 33.5 (2)	40.0 (1) / 40.0 (2)	45.0 (1) / 45.0 (2)	50.4 (1)	56.0 (1)		
	Max.	kW	25.0 (3)	31.5 (3)	37.5 (3)	45.0 (3)	50.0 (3)	56.5 (3)	63.0 (3)		
Heating capacity	Nom.	kW	22.4 (3) / 22.40 (4)	28.0 (3) / 28.00 (4)	33.5 (3) / 33.50 (4)	40.0 (3) / 40.0 (4)	45.0 (3) / 45.0 (4)	50.4 (3)	56.0 (3)		
	Max.	kW	25.0 (3)	31.5 (3)	37.5 (3)	45.0 (3)	50.0 (3)	56.5 (3)	63.0 (3)		
	Nom.	kW	5.21 (1) / 4.47 (2)	7.29 (1) / 6.32 (2)	8.98 (1) / 8.09 (2)	11.0 (1) / 9.88 (2)	13.0 (1) / 12.10 (2)	15.0 (1)	18.5 (1)		
Power input - 50Hz	Cooling	Nom.	kW	4.75 (3) / 4.47 (4)	6.29 (3) / 5.47 (4)	7.77 (3) / 6.59 (4)	9.52 (3) / 9.30 (4)	11.1 (3) / 9.8 (4)	12.6 (3)	14.5 (3)	
	Heating	Nom.	kW	5.51 (3)	7.38 (3)	9.10 (3)	11.2 (3)	12.8 (3)	14.6 (3)	17.0 (3)	
EER		kW	4.30 (1) / 5.01 (2)	3.84 (1) / 4.43 (2)	3.73 (1) / 4.14 (2)	3.64 (1) / 4.05 (2)	3.46 (1) / 3.73 (2)	3.36 (1)	3.03 (1)		
	ESEER - Automatic		7.53	7.20	6.96	6.83	6.50	6.38	5.67		
ESEER - Standard			6.37	5.67	5.50	5.31	5.05	4.97	4.42		
COP at nominal capacity		kW	4.72 (3) / 5.01 (4)	4.45 (3) / 5.12 (4)	4.31 (3) / 5.08 (4)	4.20 (3) / 4.30 (4)	4.05 (3) / 4.59 (4)	4.00	3.86		
COP at maximum capacity		kW	4.54 (3)	4.27 (3)	4.12 (3)	4.02 (3)	3.91 (3)	3.87	3.71		
Maximum number of connectable indoor units			64 (5)								
Indoor index connection	Min.		100	125	150	175	200	225	250		
	Nom.		200	250	300	350	400	450	500		
	Max.		260	325	390	455	520	585	650		
Dimensions	Unit	HeightxWidthxDepth	mm			1,685x930x765					
Weight	Unit	RYYQ/RXYQ	kg		243/187	252/194		356/305		391/314	
Fan	Air flow rate	Cooling	Nom.	m ³ /min	162	175	185	223	260	251	261
Sound power level	Cooling	Nom.	dBA		78	79	81		86		88
Sound pressure level	Cooling	Nom.	dBA		58		61		64	65	66
Operation range	Cooling	Min.~Max.	°CDB	-5~43							
	Heating	Min.~Max.	°CWB	-20~15.5							
Refrigerant	Type		R-410A								
	Charge	kg	5.9	6	6.3	10.3	10.4	11.7	11.8		
		TCO ₂ eq	12.3	12.5	13.2	21.5	21.7	24.4	24.6		
Piping connections	GWP		2,087.5								
	Liquid	OD	mm	9.52		12.7		15.9			
	Gas	OD	mm	19.1	22.2	28.6					
Power supply	Total piping length	System	Actual	m							
	Phase/Frequency/Voltage			1,000							
Current - 50Hz	Maximum fuse amps (MFA)	A	20	25	32		40		50		

Outdoor system		RYYQ/RXYQ	22T	24T/24T9	26T	28T	30T	32T	34T	36T	38T/38T9	40T	
System	Outdoor unit module 1		10T	8T		12T			16T		8T	10T	
	Outdoor unit module 2		12T	16T	14T	16T	18T	16T	18T	20T	10T	12T	
	Outdoor unit module 3						-				20T	18T	
Capacity range		HP	22	24	26	28	30	32	34	36	38	40	
Cooling capacity	Nom.	kW	61.5	67.4	73.5	78.5	83.9	90.0	95.4	101.0	106.3	111.9	
	Max.	kW	61.5	67.4	73.5	78.5	83.9	90.0	95.4	101.0	106.3	111.9	
Heating capacity	Nom.	kW	69.0	75.0	82.5	87.5	94.0	100.0	106.5	113.0	119.0	125.5	
	Max.	kW	69.0	75.0	82.5	87.5	94.0	100.0	106.5	113.0	119.0	125.5	
	Nom.	kW	16.27	18.2	20.0	22.0	24.0	26.0	28.0	31.5	29.2	31.3	
Power input - 50Hz	Cooling	Nom.	kW	14.06	15.85	17.29	18.87	20.4	22.2	23.7	25.6	25.1	26.7
	Heating	Nom.	kW	16.48	18.31	20.30	21.90	23.7	25.6	27.4	29.8	29.2	31.1
EER		kW	3.77	3.70	3.68	3.57	3.5	3.46	3.4	3.21	3.6		
	ESEER - Automatic		7.07	6.81	6.89	6.69	6.60	6.50	6.44	6.02	6.36	6.74	
ESEER - Standard			5.58	5.42	5.39	5.23	5.17	5.05	5.01	4.68	5.03	5.29	
COP at nominal capacity		kW	4.37	4.25		4.16	4.1	4.05	4.0	3.95	4.2		
COP at maximum capacity		kW	4.19	4.10	4.06	4.00		3.91	3.9	3.79	4.1	4.0	
Maximum number of connectable indoor units			64										
Indoor index connection	Min.		275	300	325	350	375	400	425	450	475	500	
	Nom.		550	600	650	700	750	800	850	900	950	1,000	
	Max.		715	780	845	910	975	1,040	1,105	1,170	1,235	1,300	
Piping connections	Liquid	OD	mm	15.9				19.1					
	Gas	OD	mm	28.6	34.9				41.3				
	Total piping length	System	Actual	m							1,000		
Current - 50Hz	Maximum fuse amps (MFA)	A	63				80				100		

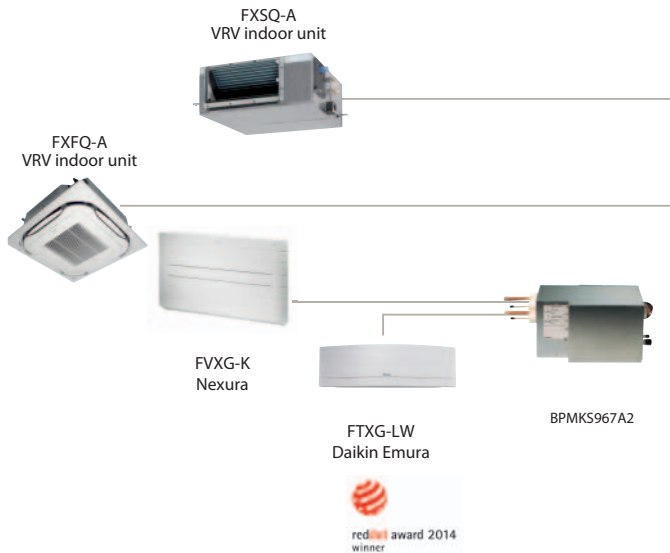

Connectable indoor units

	15 CLASS	20 CLASS	25 CLASS	35 CLASS	42 CLASS	50 CLASS	60 CLASS	71 CLASS
Daikin Emura – Wall mounted unit		FTXG20LW FTXG20LS	FTXG25LW FTXG25LS	FTXG35LW FTXG35LS		FTXG50LW FTXG50LS		
Wall mounted unit	CTXS15K	FTXS20K	FTXS25K	FTXS35K CTXS35K	FTXS42K	FTXS50K	FTXS60G	FTXS71G
Nexura – Floor standing unit			FVXG25K	FVXG35K		FVXG50K		
Floor standing unit			FVXS25F	FVXS35F		FVXS50F		
Flexi type unit			FLXS25B	FLXS35B9		FLXS50B	FLXS60B	

BPMKS box needed to connect RA indoors to VRV IV (RYYQ-T and RXYQ-T(9))

Outdoor system		RYYQ/RXYQ	42T	44T	46T	48T	50T	52T	54T	
System	Outdoor unit module 1		10T	12T	14T		16T		18T	
	Outdoor unit module 2				16T			18T		
	Outdoor unit module 3			16T				18T		
Capacity range		HP	42	44	46	48	50	52	54	
Cooling capacity	Nom.	kW	118.0	123.5	130.0	135.0	140.0	145.8	151.2	
	Max.	kW	131.5	137.5	145.0	150.0	156.0	163.0	169.5	
Heating capacity	Nom.	kW	118.0	123.5	130.0	135.0	140.0	145.8	151.2	
	Max.	kW	131.5	137.5	145.0	150.0	156.0	163.0	169.5	
	Max.	kW	32.98	34.70	36.8	38.4	40.0	42.0	43.8	
Power input - 50Hz	Cooling	Nom.	kW	33.3	35.0	37.0	39.0	40.7	43.0	45.0
	Heating	Nom.	kW	28.49	29.97	31.72	33.3	34.6	36.3	37.8
		Max.	kW	32.98	34.70	36.8	38.4	40.0	42.0	43.8
EER		kW	3.54		3.51	3.46	3.44	3.4	3.40	
ESEER - Automatic			6.65	6.62	6.60	6.50	6.46	6.42	6.38	
ESEER - Standard			5.19	5.17	5.13	5.05	5.02	4.99	4.97	
COP at nominal capacity		kW	4.14	4.12	4.10	4.05		4.0		
COP at maximum capacity		kW	3.99	3.96	3.94	3.91	3.90			
Maximum number of connectable indoor units						64				
Indoor index connection	Min.		525	550	575	600	625	650	675	
	Nom.		1,050	1,100	1,150	1,200	1,250	1,300	1,350	
	Max.		1,365	1,430	1,495	1,560	1,625	1,690	1,755	
Piping connections	Liquid	OD	mm		19.1					
	Gas	OD	mm		41.3					
	Total piping length	System	Actual	m		1,000				
Current - 50Hz	Maximum fuse amps (MFA)	A	100			125				

Outdoor unit module for RYYQ combinations		RYMQ	8T	10T	12T	14T	16T	18T	20T		
Dimensions	Unit	Height/Width/Depth	1,685/930/765			1,685/1,240/765					
Weight	Unit	kg	188	195		309		319			
Fan	Air flow rate	Cooling	Nom.	m ³ /min	162	175	185	223	260	251	261
		Sound power level	Nom.	dB(A)	78	79		81	86		88
Sound pressure level	Cooling	Nom.	dB(A)		58		61		64	65	66
Operation range	Cooling	Min.~Max.	°CDB		-5~43						
	Heating	Min.~Max.	°CWB		-20~15.5						
Refrigerant	Type		R-410A								
	Charge	kg	5.9	6	6.3	10.3	10.4	11.7	11.8		
		TCO ₂ eq		12.3	12.5	13.2	21.5	21.7	24.4	24.6	
GWP			2,087.5								
Power supply	Phase/Frequency/Voltage	Hz/V	3N~/50/380-415								
Current - 50Hz	Maximum fuse amps (MFA)	A	20	25	32	40		50			

(1) Nominal cooling capacities are based on: indoor temperature: 27°CDB, 19°CWB, outdoor temperature: 35°CDB, equivalent refrigerant piping: 5m, level difference: 0m. Data for standard efficiency series (2) Nominal cooling capacities are based on: indoor temperature: 27°CDB, 19°CWB, outdoor temperature: 35°CDB, equivalent refrigerant piping: 5m, level difference: 0m. Data for high efficiency series, Eurovent certified (3) Nominal heating capacities are based on: indoor temperature: 20°CDB, outdoor temperature: 7°CDB, 6°CWB, equivalent refrigerant piping: 5m, level difference: 0m. Data for standard efficiency series (4) Nominal heating capacities are based on: indoor temperature: 20°CDB, outdoor temperature: 7°CDB, 6°CWB, equivalent refrigerant piping: 5m, level difference: 0m. Data for high efficiency series, Eurovent certified (5) Actual number of connectable indoor units depends on the indoor unit type (VRV indoor, Hydrobox, RA indoor, etc.) and the connection ratio restriction for the system (50% <= CR <= 130%) | The STANDARD ESEER value corresponds with normal VRV4 Heat Pump operation, not taking into account advanced energy saving operation functionality | The AUTOMATIC SEER value corresponds with normal VRV4 Heat Pump operation, taking into account advanced energy saving operation functionality (variable refrigerant temperature control operation) | Contains fluorinated greenhouse gases



VRV IV S-series
heat pump

RXYSQ-TV1 / RXYSQ-TV1 / RXYSQ-TY1

A wide range, big on features



They may be discreet, but Daikin VRV IV S-series units stand out when it comes to benefits they deliver. They provide the perfect indoor climate, while remaining totally discreet from the outside. If you need efficient and effective air conditioning from a completely unnoticeable unit, look no further.

Features

- › A wide range of stylish residential or commercial indoor units can be connected
- › A total air conditioning solution integrating air handling units and/or air curtains
- › Complete reliability thanks to refrigerant-cooled PCB
- › Suitable for bigger projects of up to 150 to 200m²
- › Light weight unit (down to 88kg) is easy to install and handle
- › A perfect match for any application thanks to the wide range of small-footprint units
- › Widest range of front blow units on the market

Total solution



Daikin Emura wall mounted unit

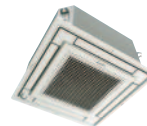

Fully flat cassette

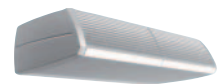

Biddle air curtain



Nexura



Fully flat cassette



Air handling unit ventilation



Most compact unit on the market 823mm high & 88kg

Compact: Easy for a two person crew to move and install.



www.youtube.com/DaikinEurope



VRV IV S-series compact heat pump

The most compact VRV

- › Compact & lightweight single fan design makes the unit almost unnoticeable
- › Covers all thermal needs of a building via a single point of contact: accurate temperature control, ventilation, air handling units and Biddle air curtains
- › Wide range of indoor units: either connect VRV or stylish indoor units such as Daikin Emura, Nexura ...
- › Incorporates VRV IV standards & technologies: Variable Refrigerant Temperature and full inverter compressors
- › 3 steps in night quiet mode: step 1: 47 dBA, step 2: 44 dBA, step 3: 41 dBA
- › Possibility to limit peak power consumption between 30 and 80%, for example during periods with high power demand
- › Contains all standard VRV features



RXYSCQ-TV1

Outdoor unit		RXYSCQ		4TV1		5TV1		
Capacity range		HP		4		5		
Cooling capacity	Nom.	kW		12.1		14.0		
	Max.	kW		14.2		16.0		
Power input - 50Hz	Cooling	Nom.	kW		3.43		4.26	
		Max.	kW		4.14		5.00	
	Heating	Nom.	kW		3.18		3.91	
		Max.	kW		4.14		5.00	
EER		kW		3.53		3.29		
COP at nominal capacity		kW		3.81		3.58		
COP at maximum capacity		kW		3.43		3.20		
Maximum number of connectable indoor units				64 (1)				
Indoor index connection	Min.			50		62.5		
	Nom.							
	Max.			130		162.5		
Dimensions	Unit	HeightxWidthxDepth		mm		823x940x460		
Weight	Unit					94		
Fan	Air flow rate	Cooling	Nom.	m ³ /min		91		
Sound power level	Cooling	Nom.		dBA		68		
						69		
Sound pressure level	Cooling	Nom.		dBA		51		
						52		
Operation range	Cooling	Min.~Max.		°CDB		-5~46		
		Min.~Max.		°CWB		-20~15.5		
Refrigerant	Type					R-410A		
	Charge			kg		3.7		
				TCO ₂ eq		7.7		
	GWP					2,087.5		
Piping connections	Liquid	OD	mm		9.52			
		Gas	OD	mm		15.9		
	Total piping length	System	Actual	m				
Power supply	Phase/Frequency/Voltage		Hz/V		1~/50/220-240			
Current - 50Hz	Maximum fuse amps (MFA)		A		32			

(1) Actual number of units depends on the indoor unit type (VRV DX indoor, RA DX indoor, etc.) and the connection ratio restriction for the system (being; 50% ≤ CR ≤ 130%).

(2) Contains fluorinated greenhouse gases

VRV IV S-series heat pump

Space saving solution without compromising on efficiency

- › Space saving trunk design for flexible installation
- › Covers all thermal needs of a building via a single point of contact: accurate temperature control, ventilation, air handling units and Biddle air curtains
- › Wide range of indoor units: either connect VRV or stylish indoor units such as Daikin Emura, Nexura ...
- › Incorporates VRV IV standards & technologies: Variable Refrigerant Temperature and full inverter compressors
- › 3 steps in night quiet mode: step 1: 47dBA, step 2: 44 dBA, step 3: 41 dBA
- › Possibility to limit peak power consumption between 30 and 80%, for example during periods with high power demand
- › Contains all standard VRV features



Outdoor unit			RXYSQ-TV1/RXYSQ-TY1	4TV1	5TV1	6TV1	4TY1	5TY1	6TY1	8TY1	10TY1	12TY1	
Capacity range			HP	4	5	6	4	5	6	8	10	12	
Cooling capacity	Nom.		kW	12.1	14.0	15.5	12.1	14.0	15.5	22.4	28.0	33.5	
	Max.		kW	14.2	16.0	18.0	14.2	16.0	18.0	25.0	31.5	37.5	
Heating capacity	Nom.		kW	12.1	14.0	15.5	12.1	14.0	15.5	22.4	28.0	33.5	
	Max.		kW	14.2	16.0	18.0	14.2	16.0	18.0	25.0	31.5	37.5	
	Max.		kW	3.43	4.09	5.25	3.43	4.09	5.25	6.22	8.33	10.25	
Power input - 50Hz	Cooling	Nom.	kW	3.03	3.73	4.56	3.03	3.73	4.56	6.12	8.24	10.15	
		Max.	kW	2.68	3.27	3.97	2.68	3.27	3.97	5.20	6.60	8.19	
	Heating	Nom.	kW	2.68	3.27	3.97	2.68	3.27	3.97	5.20	6.60	8.19	
EER			kW	4.00	3.75	3.40	4.00	3.75	3.40	3.66	3.40	3.30	
COP at nominal capacity			kW	4.52	4.28	3.90	4.52	4.28	3.90	4.31	4.24	4.09	
COP at maximum capacity			kW	4.14	3.91	3.43	4.14	3.91	3.43	4.02	3.78	3.66	
Maximum number of connectable indoor units				64 (1)									
Indoor index connection	Min.			50	62.5	70	50	62.5	70	100	125	150	
	Nom.			-									
	Max.			130	162.5	182	130	162.5	182	260	325	390	
Dimensions	Unit	HeightxWidthxDepth	mm	1,345x900x320						1,430x940x320		1,615x940x460	
Weight	Unit		kg	104									
Fan	Air flow rate	Cooling	Nom.	106						140		182	
Sound power level	Cooling	Nom.		dBA	68	69	70	68	69	70	73	74	76
		Nom.		dBA	50	51		50	51		55		57
Operation range	Cooling	Min.~Max.		°CDB	-5~46						-5~52		
		Min.~Max.		°CWB	-20~15.5						-		
Refrigerant	Type			R-410A									
	Charge		kg	3.6						4.5	7	8	
	TCO ₂ eq			7.5						9.4	14.6	16.7	
Piping connections	GWP			2,087.5									
	Liquid	OD	mm	9.52								12.7	
		Gas	OD	mm	15.9	19.1		15.9	19.1		22.2	25.4	
Total piping length		System	Actual	-									
Power supply	Phase/Frequency/Voltage		Hz/V	1N~/50/220-240				3N~/50/380-415					
Current - 50Hz	Maximum fuse amps (MFA)		A	32				16		25		32	

(1) Actual number of units depends on the indoor unit type (VRV DX indoor, RA DX indoor, etc.) and the connection ratio restriction for the system (being; 50% ≤ CR ≤ 130%).

(2) Contains fluorinated greenhouse gases



PIPE RUN OF 70M ALLOWS INSTALLATION AWAY FROM THE HOUSE



LARGE VILLA APPLICATION



PARAPET INSTALLATION

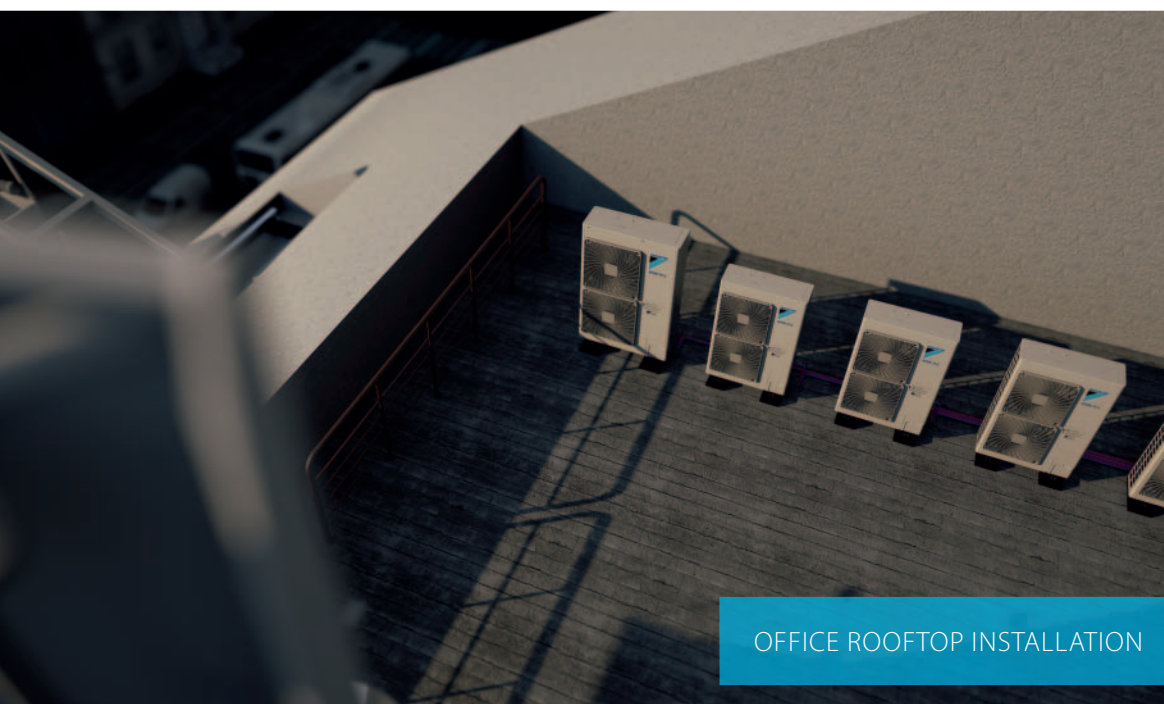

OFFICE ROOFTOP INSTALLATION



VRV IV heat pump for indoor installation

SB.RKXYQ-T

Keep looking you'll never find me

You can install highly efficient, reliable Daikin air conditioning systems in the most demanding locations while remaining invisible from street level.

Invisible

- › Completely invisible only the grilles are visible
- › Seamless integration into surrounding architecture
- › Highly suited to densely populated areas thanks to the low operation sound

Intuitive

- › Total flexibility as the outdoor unit is split up in 2 parts
- › Easy and quick to transport and install by just 2 persons
- › Easy servicability, all components can be easily reached

Intelligent

- › Patented V-shape heat exchanger for the most compact unit (400 mm high) ever
- › Connecatable to all VRV indoor units
- › Provides a total solution when combined with ventilation units, Biddle air curtains and controls

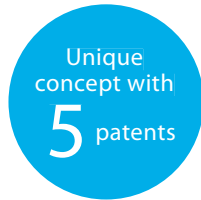

Invisible

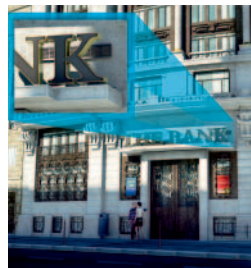

Unique split outdoor unit

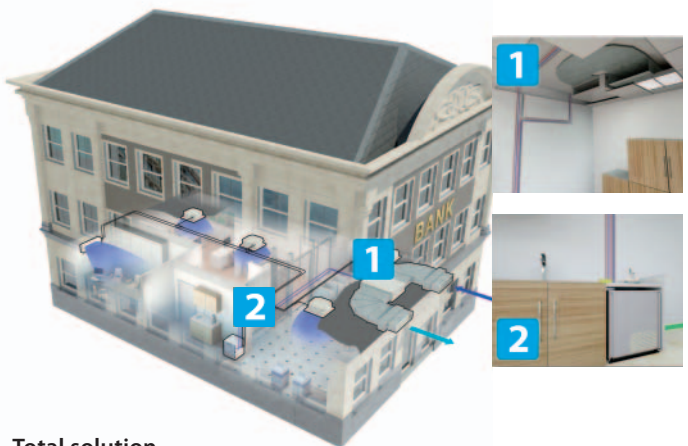

Total solution

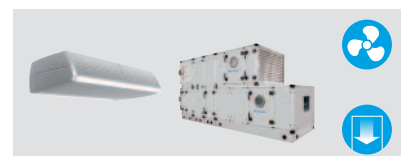

VRV IV heat pump for indoor installation

The invisible VRV

› Unique VRV heat pump for indoor installation

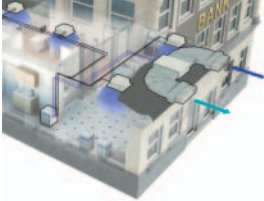

› Unrivalled flexibility because the unit is split up into two elements: the heat exchanger and the compressor

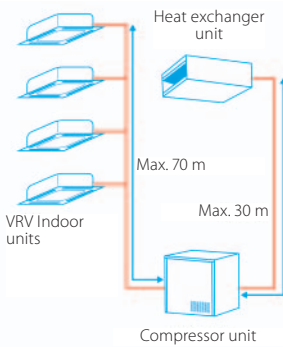

› Highly suited to densely populated areas thanks to the low operation sound and seamless integration into surrounding architecture as only the grille is visible



SB.RKXYQ-T

- › Incorporates VRV IV standards & technologies: Variable Refrigerant Temperature, VRV configurator, full inverter compressors and refrigerant cooled PCB
- › Lightweight units (max. 97kg) can be installed by two people
- › Unique V-shape heat exchanger results in compact dimensions (h/e unit only 400mm high) allowing false ceiling installation, while ensuring top efficiency
- › Super efficient centrifugal fans (over 50% efficiency increase compared to sirocco fan)
- › Small footprint compressor unit (600 x 550 mm) maximizing useable floor space
- › Contains all standard VRV features

Outdoor system				SB.RKXYQ	5T
System	Compressor unit				RKXYQ5T
	Heat exchanger unit				RDXYQ5T
Capacity range				HP	5
Cooling capacity	Nom.	35°CDB		kW	14.0
Heating capacity	Nom.	6°CWB		kW	14.0
	Max.	6°CWB		kW	16.0
Power input - 50Hz	Cooling	Nom.	35°CDB	kW	4.38
		Nom.	6°CWB	kW	3.68
	Max.	6°CWB	kW	4.71	
EER	at nom. capacity		35°CDB	kW/kW	3.20
COP	at nom. capacity		6°CWB	kW/kW	3.80
	at max. capacity		6°CWB	kW/kW	3.40
Maximum number of connectable indoor units					10 (1)
Indoor index connection	Min.				62.5
	Nom.				-
	Max.				162.5
Fan	External static pressure	Max.		Pa	150
		Nom.		Pa	60
Operation range	Cooling	Min.~Max.		°CDB	-5~46
		Min.~Max.		°CWB	-20~15.5
	Temperature around casing	Min.		°CDB	5
		Max.		°CDB	35
Piping connections	Between Compressor module (CM) and heat exchanger module (HM)	Liquid	OD	mm	12.7
		Gas	OD	mm	19.1
	Between Compressor module (CM) and indoor units (IU)	Liquid	OD	mm	9.5
		Gas	OD	mm	15.9
	Total piping length	System	Actual	m	140

(1) Actual number of units depends on the indoor unit type (VRV DX indoor, etc.) and the connection ratio restriction for the system (being; 50% ≤ CR ≤ 130%).

Outdoor unit module				RKXYQ5T - compressor module	RDXYQ5T - heat exchanger module
Dimensions	Unit	Height/Width/Depth		mm	701/600/554
Weight	Unit			kg	77
Fan	Type				Centrifugal
	Air flow rate	Cooling	Nom.	m ³ /min	55
	Discharge direction				
Sound power level	Cooling	Nom.		dBA	-
Sound pressure level	Cooling	Nom.		dBA	47
Refrigerant	Type				R-410A
	Charge			kg	2
				TCO ₂ eq	4.2
	GWP				2,087.5
Power supply	Phase/Frequency/Voltage		Hz/V	3N~/50/380-415	1N~/50/220-240
Current - 50Hz	Maximum fuse amps (MFA)		A	16	10

VRVIII heat pump, optimised for heating

Where heating is priority without compromising on efficiency

- › First system in the industry developed for heating operation in low ambient conditions, making it suitable for single source heating
- › Extended operation range down to -25°C in heating
- › Stable heating capacity and high COP values at low ambients thanks to the two stage compression technology (COP values of 3.0 and more at -10°C)
- › Improved comfort thanks to shorter defrost time
- › Shorter heat up time compared to standard VRVIII heat pump
- › Contains all standard VRV features



RTSYQ14-16PA

Outdoor system				RTSYQ	10PA	14PA	16PA	20PA
System	Outdoor unit module 1				RTSQ10PAY1	RTSQ14PAY1	RTSQ16PAY1	RTSQ8PAY1
	Outdoor unit module 2					-		RTSQ12PAY1
	Function unit				BTSQ20PY1			
Capacity range			HP	10	14	16	20	
Cooling capacity	Nom.		kW	28.0	40.0	45.0	56.0	
Heating capacity	Nom.		kW	31.5 (1) / 28.0 (2)	45.0 (1) / 40.0 (2)	50.0 (1) / 45.0 (2)	63.0 (1) / 55.9 (2)	
Power input - 50Hz	Cooling	Nom.	kW	7.90	12.6	14.9	15.4	
	Heating	Nom.	kW	7.78 (1) / 8.18 (2)	11.4 (1) / 12.8 (2)	13.0 (1) / 15.0 (2)	15.4 (1) / 18.7 (2)	
EER			kW	3.54	3.17	3.02	3.64	
COP			kW	4.05 (1) / 3.42 (2)	3.95 (1) / 3.13 (2)	3.85 (1) / 3.00 (2)	4.09 (1) / 2.99 (2)	
Maximum number of connectable indoor units					21	30	34	43
Indoor index connection	Min.			125	175	200	250	
	Nom.			250	350	400	500	
	Max.			325	455	520	650	
Sound pressure level	Cooling	Nom./Max.	dB(A)	60/62	61/63	63/65		
Piping connections	Liquid	OD	mm	9.52		12.7		15.9
	Gas	OD	mm	22.2			28.6	
	Oil equalizing	OD	mm			-		19.1
	Total piping length	System	Actual	m			500	
Current - 50Hz	Maximum fuse amps (MFA)			A	25	35	40	50

(1) Heating: Indoor temp. 20°CDB; outdoor temp. 7°CDB, 6°CWB (2) Heating: Indoor temp. 20°CDB; outdoor temp. -10°CWB

Outdoor unit module				RTSQ	20P	8PA	10PA	12PA	14PA	16PA
Dimensions	Unit	Height/Width/Depth		mm	1,570/460/765		1,680/930/765		1,680/1,240/765	
Weight	Unit			kg	110	205	257		338	344
Fan	Air flow rate	Cooling	Nom.	m ³ /min	-		185	200	233	239
Sound power level	Cooling	Nom.		dB(A)						
Operation range	Cooling	Min.~Max.		°CDB			-5~43			
	Heating	Min.~Max.		°CWB			-25~-15.5			
Refrigerant	Type	R-410A								
	Charge			kg	-	9.4	10.5	10.9		11.7
				TCO ₂ eq	-	19.6	21.9	22.8		24.4
	GWP	2,087.5								
Power supply	Phase/Frequency/Voltage			Hz/V			3~/50/380-415			
Current - 50Hz	Maximum fuse amps (MFA)			A	20		25		35	40

VRV Classic

Classic VRV configuration

- › For standard cooling & heating requirements
- › Connectable to all standard VRV indoor units, controls and ventilation
- › Contains all standard VRV features



Outdoor unit		RXYCQ	8A	10A	12A	14A	16A	18A	20A	
Capacity range		HP	8	10	12	14	16	18	20	
Cooling capacity	Nom.	kW	20.0	25.0	30.0	35.0	40.0	45.0	50.4	
Heating capacity	Nom.	kW	22.4	28.0	33.6	31.5	44.8	50.4	56.5	
Power input - 50Hz	Cooling	Nom.	kW	6.60	6.74	8.77	11.4	12.9	17.9	
	Heating	Nom.	kW	5.80	7.00	8.62	8.18	11.8	16.1	
EER		kW	3.03	3.71	3.42	3.07	3.10	3.00	2.81	
COP		kW	3.86	4.00	3.90	3.85	3.80	3.65	3.50	
Maximum number of connectable indoor units			64							
Indoor index connection	Min.		100	125	150	175	200	225	250	
	Nom.		200	250	300	350	400	450	500	
	Max.		200	250	360	420	480	540	600	
Dimensions	Unit	HeightxWidthxDepth	mm	1,680x635x765		1,680x930x765		1,680x1,240x765		
Weight	Unit		kg	159	187	240		316	324	
Fan	Air flow rate	Cooling	Nom.	m ³ /min	95	171	185	196	233	239
Sound power level	Cooling	Nom.		dB(A)	78	81		86	88	
Sound pressure level	Cooling	Nom.		dB(A)	58	59	61	64	65	66
Operation range	Cooling	Min.~Max.		°CDB	-5~43					
	Heating	Min.~Max.		°CWB	-20~15.5					
Refrigerant	Type			R-410A						
	Charge		kg	6.2	7.7	8.4	8.6	11.3	11.5	11.7
			TCO ₂ eq	12.9	16.1	17.5	18	23.6	24	24.4
Piping connections	GWP			2,087.5						
		Liquid	OD	mm	9.52		12.7		15.9	
	Gas	OD	mm	15.9	19.1	22.2	28.6			
	Total piping length	System	Actual		300					
Power supply	Phase/Frequency/Voltage			3N~/50/380-415						
Current - 50Hz	Maximum fuse amps (MFA)		A	16	25		40			

Contains fluorinated greenhouse gases

Replacement technology



The quick and quality way of upgrading R-22 and R-407C systems

These benefits will convince your customer

Drastically improve your efficiency, comfort and reliability

Avoid loss of business

Replacing now prevents unplanned, lengthy downtime of air conditioning systems. It also avoids loss of business for shops, complaints from guests in hotels, lower working efficiency and loss of tenants in offices.

Quick and easy installation

No interruption of daily business while replacing the system thanks to phased-in, fast installation.

Smaller footprint, more performance

Thanks to a smaller footprint, Daikin outdoor units save space. Also, more indoor units can be connected to the new outdoor unit compared to the old system, allowing to increase capacity.

Lower long-term costs

EU Directives prohibit system repairs with R-22 after January 1, 2015. Delaying the required R-22 replacement until an unplanned system breakdown is a losing game. Replacement day will come. Installing a technically advanced system lowers energy consumption and maintenance costs from day one.

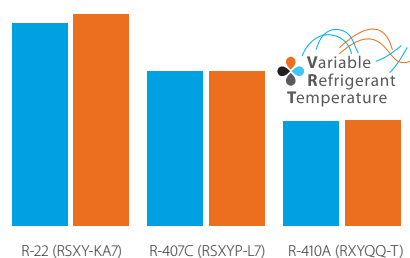

Up to 48% less consumption

Comparison of 10HP systems:
■ Cooling mode
■ Heating mode

Keep your refrigerant piping

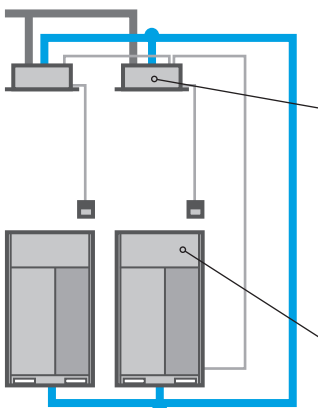

The Daikin low-cost upgrade solution

! Replace indoor units and BS boxes

Contact your local dealer to check compatibility in case you need to keep the indoor units.

! Replace outdoor units

Your copper pipes will last for multiple generations

- > copper pipes used in air conditioning systems tested by Daikin will last over 60 years after installation.
- > Japan/China have replaced with VRV Q-series already 10 years ago!

Umeda Center Building, Japan

- > original A/C system: 20 years in use
- > replacement with VRV Q-series: 2006 - 2009
- > capacity up from 1620HP to 2322HP
- > SHASE renewal award:





! Planning your replacement in future?

Monitor your system now!

Your building use might have changed over the years. Monitoring and Daikin expert advice prepare you for an optimum replacement to maximize efficiency and comfort, while minimizing the investment cost of your new system.

VRV-Q benefits to increase your profit

Optimise your business

Less installation time

Tackle more projects in less time thanks to faster installation. It is more profitable than replacing the full system with new piping.

Lower installation costs

Reducing installation costs enables you to offer customers the most cost-effective solution and improve your competitive edge.

Replace non-Daikin systems **NON DAIKIN** **DAIKIN**

It is a trouble-free replacement solution for Daikin systems and for systems made by other manufacturers.

Easy as one-two-three

A simple solution for replacement technology enables you to handle more projects for more customers in less time and offer them the best price! Everybody gains.

Automatic refrigerant charge

The unique automatic refrigerant charge eliminates the need to calculate refrigerant volume and ensures that the system will operate perfectly. Not knowing the exact piping lengths because of changes or mistakes in case you didn't do the original installation or replacing a competitor installation no longer poses a problem.

Automatic pipe cleaning

There is no need to clean inside piping as this is handled automatically by the VRV-Q unit. Finally the test operation is performed automatically to save time.

Compare installation steps

Conventional solution

- 1 Recover refrigerant
- 2 Remove units
- 3 Remove refrigerant pipes
- 4 Install new piping and wiring
- 5 Install new units
- 6 Leak test
- 7 Vacuum drying
- 8 Refrigerant charging
- 9 Collect contamination
- 10 Test operation

VRV-Q

- 1 Recover refrigerant
- 2 Remove units
- Re-use existing piping and wiring
- 3 Install new units
- 4 Leak test
- 5 Vacuum drying
- 6 Automatic refrigerant charging, cleaning and testing



Up to 45% shorter installation time

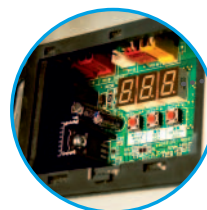

One touch convenience:

- > Measure and charge refrigerant
- > Automatic pipe cleaning
- > Test operation



Replacement VRV

- › Cost effective and fast replacement as only the outdoor and indoor unit needs to be replaced, meaning almost no work has to be carried out inside the building
- › Efficiency gains of more than 70% can be realized, by virtue of technological developments in heat pump technology and the more efficient R-410A refrigerant
- › Less intrusive and time consuming installation compared to installing a new system, as the refrigerant piping can be maintained
- › Unique automatic refrigerant charge eliminates the need to calculate refrigerant volume and allows safe replacement of competitor replacement
- › Automatic cleaning of refrigerant piping ensures a clean piping network, even when a compressor breakdown has occurred
- › Accurate temperature control, fresh air provision, air handling units and Biddle air curtains all integrated in a single system requiring only one single point of contact
- › Incorporates VRV IV standards & technologies: Variable Refrigerant Temperature and full inverter compressors
- › Possibility to add indoor units and increase capacity without changing the refrigerant piping
- › Possibility to spread the various stages of replacement thanks to the modular design of the VRV system
- › Free combination of outdoor units to meet installation space or efficiency requirements
- › Contains all standard VRV features



Outdoor system		RQCEQ	280P3	360P3	460P3	500P3	540P3	636P3	712P3	744P3	816P3	848P3	
System	Outdoor unit module 1		RQEQ140P3	RQEQ180P3	RQEQ140P3		RQEQ180P3	RQEQ212P3	RQEQ140P3		RQEQ180P3	RQEQ212P3	
	Outdoor unit module 2		RQEQ140P3	RQEQ180P3	RQEQ140P3	RQEQ180P3		RQEQ212P3	RQEQ180P3		RQEQ212P3		
	Outdoor unit module 3		-		RQEQ180P3			RQEQ212P3	RQEQ180P3	RQEQ212P3			
	Outdoor unit module 4		-			-			RQEQ180P3		RQEQ212P3		
Capacity range		HP	10	13	16	18	20	22	24	26	28	30	
Cooling capacity	Nom.	kW	28.0	36.0	45.0	50.0	54.0	63.6	71.2	74.4	81.6	84.8	
Heating capacity	Nom.	kW	32.0	40.0	52.0	56.0	60.0	67.2	78.4	80.8	87.2	89.6	
Power input - 50Hz	Cooling	Nom.	kW	7.04	10.3	12.2	13.9	15.5	21.9	21.2	23.3	27.1	29.2
	Heating	Nom.	kW	8.00	10.7	13.4	14.7	16.1	17.7	20.7	21.2	23.1	23.6
EER		kW	3.98	3.48	3.77	3.61	3.48	2.90	3.36	3.19	3.01	2.90	
COP		kW	4.00	3.72	3.89	3.80	3.72	3.79	3.80	3.81	3.77	3.79	
Maximum number of connectable indoor units			21	28	34	39	43	47	52	56	60	64	
Indoor index connection	Min.		140	180	230	250	270	318	356	372	408	424	
	Nom.		280	360	500		540	636	712	744	816	848	
	Max.		364	468	598	650	702	827	926	967.0	1,061	1,102	
Sound pressure level	Cooling	Nom.	dB(A)	57	61		62	63	64	63	64	65	66
	Piping connections	Liquid	OD	mm	9.52	12.7		15.9			19.1		
Gas		OD	mm	22.2	25.4	28.6			34.9				
Discharge gas		OD	mm	19.1		22.2			25.4		28.6		
Total piping length	System	Actual	m			300							
Current - 50Hz	Maximum fuse amps (MFA)	A	30	40	50	60	70	80	90				

Contains fluorinated greenhouse gases

Outdoor unit module		RQEQ	140P3		180P3		212P3	
Dimensions	Unit	Height/Width/Depth	mm		1,680/635/765			
Weight	Unit		kg		175		179	
Fan	Air flow rate	Cooling	Nom.	m ³ /min	95		110	
		Heating	Nom.		-		-	
Sound power level	Cooling	Nom.	dB(A)	54		58		60
Operation range	Cooling	Min.~Max.	°CDB	-5~43		-20~15.5		
Refrigerant	Type		R-410A					
	Charge		kg	10.3		10.6		11.2
			TCO ₂ eq	21.5		22.1		23.4
	GWP		2,087.5					
Power supply	Phase/Frequency/Voltage	Hz/V	3~/50/380-415					
Current - 50Hz	Maximum fuse amps (MFA)	A	15		20		22.5	

Replacement VRV



Outdoor unit				RXYQ-Q-T	RQYQ140P	8T	10T	12T	14T	16T	18T	20T
System	Outdoor unit module 1				RQYQ140P							
Capacity range				HP	5	8	10	12	14	16	18	20
Cooling capacity	Nom.			kW	14.0	22.4	28.0	33.5	40.0	45.0	50.4	56.0
Heating capacity	Nom.			kW	16.0	22.4	28.0	33.5	40.00	45.0	50.4	56.0
	Max.			kW	-	25.00	31.50	37.50	45.00	50.00	56.50	63.00
Power input - 50Hz	Cooling	Nom.		kW	3.36	5.21	7.29	8.98	11.0	13.0	15.0	18.5
		Heating	Nom.	kW	3.91	4.75	6.29	7.77	9.52	11.1	12.6	14.50
		Max.		kW	-	5.5	7.38	9.1	11.2	12.8	14.6	17.0
EER				kW	4.17	4.30	3.84	3.73	3.64	3.46	3.36	3.03
ESEER - Automatic					-	7.53	7.20	6.96	6.83	6.50	6.38	5.67
ESEER - Standard					-	6.37	5.67	5.50	5.31	5.05	4.97	4.42
COP at nominal capacity				kW	4.09	4.72	4.45	4.31	4.20	4.05	4.00	3.86
COP at maximum capacity				kW	-	4.54	4.27	4.12	4.02	3.91	3.87	3.71
Maximum number of connectable indoor units					10					64		
Indoor index connection	Min.				62.5	100	125	150	175	200	225	250
	Nom.				125	200	250	300	350	400	450	500
	Max.				162.5	260	325	390	455	520	585	650
Dimensions	Unit	HeightxWidthxDepth		mm	1,680x635x765	1,685x930x765			1,685x1,240x765			
Weight	Unit			kg	175	187	194		305		314	
Fan	Air flow rate	Cooling	Nom.	m ³ /min	95	162	175	185	223	260	251	261
Sound power level	Cooling	Nom.		dBA	-	78	79		81		86	88
Sound pressure level	Cooling	Nom.		dBA	54.0		58		61		64	65
Operation range	Cooling	Min.~Max.		°CDB					-5~43			
	Heating	Min.~Max.		°CWB					-20~15.5			
Refrigerant	Type					R-410A						
	Charge			kg	11.1	5.9	6	6.3	10.3	10.4	11.7	11.8
				TCO ₂ eq	23.2	12.3	12.5	13.2	21.5	21.7	24.4	24.6
Piping connections	Liquid	OD	mm			9.52			12.7		15.9	
		Gas	OD	mm	15.9	19.1	22.2			28.6		
	Total piping length	System	m			300						
		Actual	m			300						
Power supply	Phase/Frequency/Voltage			Hz/V	3~/50/380-415		3N~/50/380-415					
Current - 50Hz	Maximum fuse amps (MFA)			A	15	20	25	32	40	50		

Outdoor unit				RXYQ-Q-T	22T	24T	26T	28T	30T	32T	34T	36T	38T	40T	42T	
System	Outdoor unit module 1				RXYQ10T	RXYQ08T	RXYQ12T			RXYQ16T			RXYQ08T	RXYQ10T		
	Outdoor unit module 2				RXYQ12T	RXYQ16T	RXYQ14T	RXYQ16T	RXYQ18T	RXYQ16T	RXYQ18T	RXYQ20T	RXYQ10T	RXYQ12T	RXYQ16T	
	Outdoor unit module 3												RXYQ20T	RXYQ18T	RXYQ16T	
Capacity range				HP	22	24	26	28	30	32	34	36	38	40	42	
Cooling capacity	Nom.			kW	61.5	67.4	73.5	78.5	83.9	90.0	95.4	101.0	106.3	111.9	118.0	
Heating capacity	Nom.			kW	69.0	75.0	82.5	87.5	83.9	100.0	95.4	113.0	106.3	111.9	131.5	
	Max.			kW					94.0	-	106.5	-	119.0	125.5	-	
Power input - 50Hz	Cooling	Nom.		kW	16.27	18.21	19.98	21.98	24.0	26.0	28.0	31.5	29.2	31.3	33.29	
		Heating	Nom.	kW	16.48	18.31	20.30	21.90	20.4	25.6	23.7	29.8	25.1	26.7	32.98	
		Max.		kW					23.7	-	27.4	-	29.2	31.1	-	
EER				kW	3.78	3.70	3.68	3.57		3.5		3.4	3.2		3.54	
ESEER - Automatic					7.07	6.81	6.89	6.69	6.60	6.50	6.44	6.02	6.36	6.74	6.65	
ESEER - Standard					5.58	5.42	5.39	5.23	5.17	5.05	5.01	4.68	5.03	5.29	5.19	
COP at nominal capacity				kW	4.37		4.25	4.16	4.10	4.05	4.00	3.95		4.2	4.14	
COP at maximum capacity				kW	4.19	4.10	4.06		4.00	3.91	3.90	3.79	4.1	4.0	3.99	
Maximum number of connectable indoor units										64						
Indoor index connection	Min.				275	300	325	350	375	400	425	450	475	500	525	
	Nom.				550	600	650	700	750	800	850	900	950	1,000	1,050	
	Max.				715	780	845	910	975	1,040	1,105	1,170	1,235	1,300	1,365	
Piping connections	Liquid	OD	mm		15.9						19.1					
		Gas	OD	mm	28.6				34.9			41.3				
	Total piping length	System	m		300											
		Actual	m		300											
Current - 50Hz	Maximum fuse amps (MFA)			A	63			80			100					

Contains fluorinated greenhouse gases | The STANDARD ESEER value corresponds with normal VRV4 Heat Pump operation, not taking into account advanced energy saving operation functionality | The AUTOMATIC SEER value corresponds with normal VRV4 Heat Pump operation, taking into account advanced energy saving operation functionality (variable refrigerant temperature control operation) | Actual number of connectable indoor units depends on the indoor unit type (VRV indoor, Hydrobox, RA indoor, etc.) and the connection ratio restriction for the system (50% <= CR <= 130%)

RWEYQ-T8

Water-to-air heat pump

Indoor installation makes unit invisible from the outside

- > Seamless integration in the surrounding architecture as you cannot see the unit
- > Highly suited for sound sensitive areas as there is no external operation sound
- > Superior efficiency, even in the most extreme outside conditions, especially in geothermal operation



Unified range for heat pump & heat recovery and standard & geothermal series



+

Connectable to widest and most compact range of VRV IV BS boxes

Variable water flow control

- > The variable water flow control option reduces excessive energy use by the circulation pump.
- > By controlling a variable water valve, the water flow is reduced when possible, saving energy.

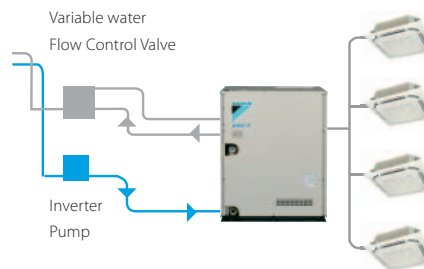

Lower refrigerant levels

Water-cooled VRV systems typically have less refrigerant per system making it ideal to comply with the EN378 legislation limiting the amount of refrigerant in hospitals and hotels.

The refrigerant levels remain limited thanks to:

- > limited distance between outdoor and indoor unit
- > modularity: enabling small systems per floor instead of one big system. Thanks to the water circuit heat recovery is still possible in the entire building

2-stage heat recovery

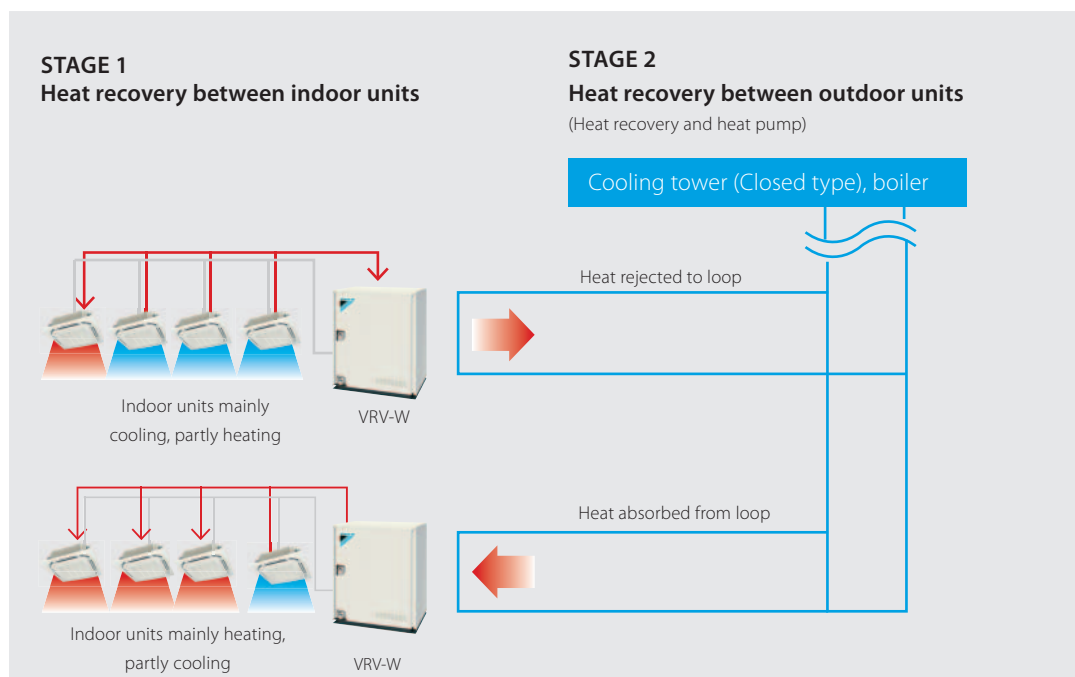

VRV IV water cooled series

Ideal for high rise buildings, using water as heat source

- › Unified range for standard and geothermal series simplifies stock. Geothermal series reduce CO₂ emissions thanks to the use of geothermal energy as a renewable energy source
- › No need for an external heating or cooling source when used in geothermal mode
- › Covers all thermal needs of a building via a single point of contact: accurate temperature control, ventilation, air handling units and Biddle air curtains
- › Compact & lightweight design can be stacked for maximum space saving
- › Incorporates VRV IV standards & technologies: Variable Refrigerant Temperature and full inverter compressors
- › 2-stage heat recovery: first stage between indoor units, second stage between outdoor units thanks to the storage of energy in the water circuit
- › Available in heat pump and heat recovery version
- › Variable Water Flow control option increases flexibility and control
- › Contains all standard VRV features

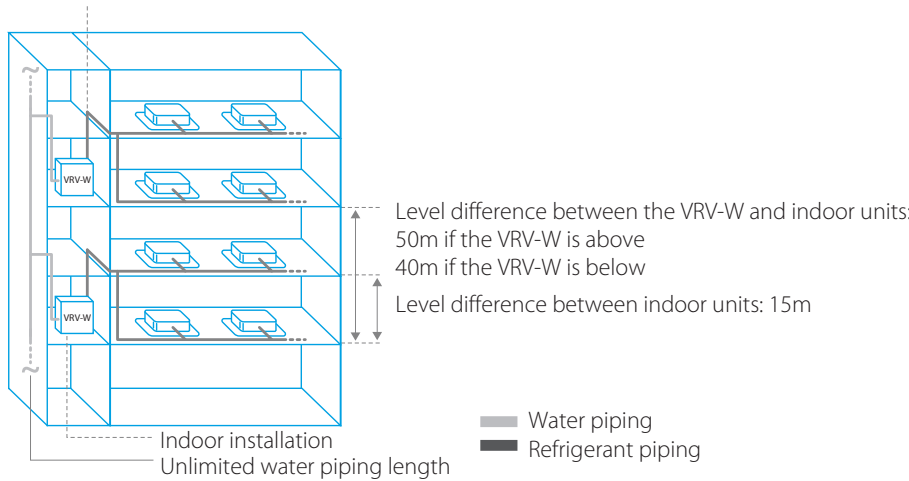

Outdoor unit		RWEYQ	8T8	10T8	16T8	18T8	20T8	24T8	26T8	28T8	30T8	
System	Outdoor unit module 1		RWEYQ8T	RWEYQ10T	RWEYQ8T		RWEYQ10T	RWEYQ8T		RWEYQ10T		
	Outdoor unit module 2		-	-	RWEYQ8T	RWEYQ10T	RWEYQ8T		RWEYQ10T			
	Outdoor unit module 3		-	-	-	-	RWEYQ8T	RWEYQ10T				
Capacity range		HP	8	10	16	18	20	24	26	28	30	
Cooling capacity	Nom.	kW	22.4 (1) / 22.4 (2)	28.0 (1) / 27.5 (2)	44.8 (1) / 44.8 (2)	50.4 (1) / 49.9 (2)	56.0 (1) / 55.0 (2)	67.2 (1) / 67.2 (2)	72.8 (1) / 72.3 (2)	78.4 (1) / 77.4 (2)	84.0 (1) / 82.5 (2)	
Heating capacity	Nom.	kW	25.0 (3) / 25.0 (4)	31.5 (3) / 31.5 (4)	50.0 (3) / 50.0 (4)	56.5 (3) / 56.5 (4)	63.0 (3) / 63.0 (4)	75.0 (3) / 75.0 (4)	81.5 (3) / 81.5 (4)	88.0 (3) / 88.0 (4)	94.5 (3) / 94.5 (4)	
Power input - 50Hz	Cooling	Nom.	kW	4.42 (1) / 4.45 (2)	6.14 (1) / 6.35 (2)	8.8 (1) / 8.9 (2)	10.6 (1) / 10.8 (2)	12.3 (1) / 12.7 (2)	13.3 (1) / 13.4 (2)	15.0 (1) / 15.3 (2)	16.7 (1) / 17.2 (2)	18.4 (1) / 19.1 (2)
	Heating	Nom.	kW	4.21 (3) / 4.30 (4)	6.00 (3) / 6.20 (4)	8.4 (3) / 8.6 (4)	10.2 (3) / 10.5 (4)	12.0 (3) / 12.4 (4)	12.6 (3) / 12.9 (4)	14.4 (3) / 14.8 (4)	16.2 (3) / 16.7 (4)	18.0 (3) / 18.6 (4)
EER		kW	5.07 (1) / 5.03 (2)	4.56 (1) / 4.33 (2)	5.07 (1) / 5.03 (2)	4.77 (1) / 4.62 (2)	4.56 (1) / 4.33 (2)	5.07 (1) / 5.03 (2)	4.86 (1) / 4.74 (2)	4.69 (1) / 4.51 (2)	4.56 (1) / 4.33 (2)	
COP		kW	5.94 (3) / 5.81 (4)	5.25 (3) / 5.08 (4)	5.94 (3) / 5.81 (4)	5.53 (3) / 5.38 (4)	5.25 (3) / 5.08 (4)	5.94 (3) / 5.81 (4)	5.65 (3) / 5.51 (4)	5.43 (3) / 5.27 (4)	5.25 (3) / 5.08 (4)	
Maximum number of connectable indoor units			36 (5)									
Indoor index connection	Min.		100	125	200	225	250	300	325	350	375	
	Nom.		200	250	400	450	500	600	650	700	750	
	Max.		260	325	520	585	650	780	845	910	975	
Dimensions	Unit	HeightxWidthxDepth	mm 1,000x780x550									
Weight	Unit		kg 137									
Sound power level	Cooling	Nom.	dBA									
Sound pressure level	Cooling	Nom.	50	51	53	54			55		56	
Operation range	Inlet water temperature	Cooling	Min.-Max.	°CDB 10~45								
		Heating	Min.-Max.	°CWB -10 / 10.0~45								
Refrigerant	Type		R-410A									
	Charge	kg	3.5	4.2							-	
		TCO ₂ eq	7.3	8.8							-	
Piping connections	Liquid	OD	mm 9.52		12.7	15.9		19.1				
		Gas	OD	mm 19.10 (6)		22.2 (6)	28.6 (6)		34.9 (6)			
	Discharge gas	OD	mm 15.9 (7) / 19.10 (8)		19.1 (7) / 22.10 (8)	22.2 (7) / 28.60 (8)		28.6 (7) / 34.90 (8)				
		Water	Inlet/Outlet	ISO 228 - G1 1/4 B External Thread/ISO 228 - G1 1/4 B External Thread								
	Total piping length	System	Actual	m 300								
Power supply	Phase/Frequency/Voltage	Hz/V	3N~/50/380-415						-			
Current - 50Hz	Maximum fuse amps (MFA)	A	20			32			50			

(1) Cooling: Indoor temp. 27°CDB; 19°CWB; inlet water temp.: 30°C; equivalent refrigerant piping: 7.5m; level difference: 0m. Rated values are with 100% water (no glycol) (2) Cooling: Indoor temp. 27°CDB; 19°CWB; inlet water temp.: 30°C; equivalent refrigerant piping: 7.5m; level difference: 0m. Rated values are with 30% glycol. (3) Heating: Indoor temp. 20°CDB; inlet water temp.: 20°C; equivalent refrigerant piping: 7.5m; level difference: 0m. Rated values are with 100% water (no glycol). (4) Heating: Indoor temp. 20°CDB; inlet water temp.: 20°C; equivalent refrigerant piping: 7.5m; level difference: 0m. Rated values are with 30% glycol. (5) Actual number of connectable indoor units depends on the indoor unit type (VRV indoor, Hydrobox, RA indoor, etc.) and the connection ratio restriction for the system (50% <= CR <= 130%) (6) In case of heat pump system, gas pipe is not used (7) In case of heat recovery system (8) In case of heat pump system | Contains fluorinated greenhouse gases

Individual branch selector for VRV IV heat recovery

- › Unique range of single and multi BS boxes for flexible and fast design
- › Compact & light to install
- › Ideal for remote rooms as no drain piping is needed
- › Allows integration of server rooms into the heat recovery solution thanks to technical cooling function
- › Connect up to 250 class unit (28kW)
- › Faster installation thanks to open connection
- › Allows multi tenant applications
- › Connectable to REYQ-T and RWEYQ-T8 VRV IV heat recovery units

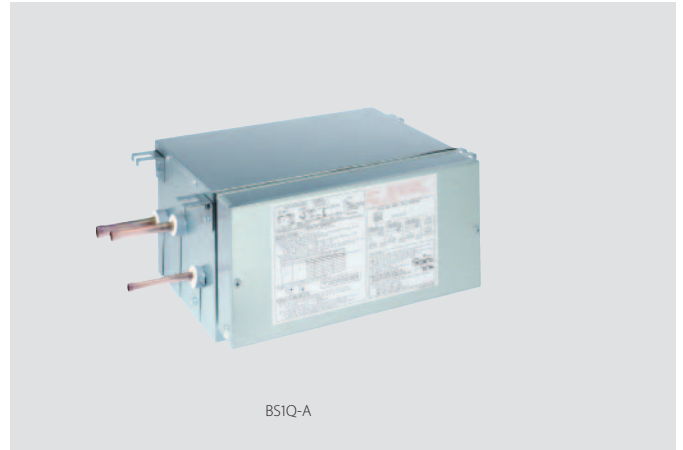

Indoor unit		BS		1Q10A	1Q16A	1Q25A
Power input	Cooling	Nom.	kW		0.005	
	Heating	Nom.	kW		0.005	
Maximum number of connectable indoor units				6		8
Maximum capacity index of connectable indoor units				15 < x ≤ 100	100 < x ≤ 160	160 < x ≤ 250
Dimensions	Unit	HeightxWidthxDepth		mm		
Weight	Unit			12		15
Casing	Material		Galvanised steel plate			
Piping connections	Outdoor unit	Liquid	OD	mm		
		Gas	OD	mm		
		Discharge gas	OD	mm		
	Indoor unit	Liquid	OD	mm		
		Gas	OD	mm		
				15.9	9.5	22.2
			12.7		19.1	
Sound absorbing thermal insulation				Foamed polyurethane Flame-resistant needle felt		
Power supply	Phase		1~			
	Frequency		50			
	Voltage		220-240			
Total circuit	Maximum fuse amps (MFA)		A			15

Multi branch selector for VRV IV heat recovery

- › Unique range of single and multi BS boxes for flexible and fast design
- › Major reduction in installation time thanks to wide range, compact size and light weight multi BS boxes
- › Up to 70% smaller and 66% lighter than previous series
- › Faster installation thanks to a reduced number of brazing points and wiring
- › All indoor units connectable to one BS box
- › Less inspection ports needed compared to installing single BS boxes
- › Up to 16kW capacity available per port
- › Connect up to 250 class unit (28kW) by combining 2 ports
- › No limit on unused ports allowing phased installation
- › Faster installation thanks to open connection
- › Connectable to REYQ-T and RWEYQ-T8 VRV IV heat recovery units



Indoor unit				BS	4Q14AV1	6Q14AV1	8Q14AV1	10Q14AV1	12Q14AV1	16Q14AV1	
Power input	Cooling	Nom.		kW	0.043	0.064	0.086	0.107	0.129	0.172	
		Nom.		kW	0.043	0.064	0.086	0.107	0.129	0.172	
Maximum number of connectable indoor units					20	30	40	50	60	64	
Maximum number of connectable indoor units per branch							5				
Number of branches					4	6	8	10	12	16	
Maximum capacity index of connectable indoor units					400	600		750			
Maximum capacity index of connectable indoor units per branch							140				
Dimensions	Unit	HeightxWidthxDepth		mm	298x370x430	298x580x430		298x820x430		298x1,060x430	
Weight	Unit			kg	17	24	26	35	38	50	
Casing	Material		Galvanised steel plate								
Piping connections	Outdoor unit	Liquid	OD	mm	9.5	12.7	12.7 / 15.9	15.9	15.9 / 19.1		19.1
			Gas	OD	mm	22.2 / 19.1	28.6 / 22.2	28.6	28.6 / 34.9		34.9
		Discharge gas	OD	mm	19.1 / 15.9	19.1 / 22.2	19.1 / 22.2 / 28.6	28.6			
	Indoor unit	Liquid	OD	mm	9.5 / 6.4						
			Gas	OD	mm	15.9 / 12.7					
		Drain	VP20 (I.D. 20/O.D. 26)								
Sound absorbing thermal insulation	Urethane foam, polyethylene foam										
Power supply	Phase		1~								
	Frequency		50								
	Voltage		220-440								
Total circuit	Maximum fuse amps (MFA)		A								
				15							







FXZQ-A

Products overview

Capacity class (kW)











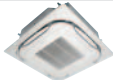

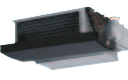
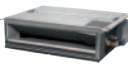
Type	Model	Product name	15	20	25	32	40	50	63	71	80	100	125	140	200	250	
	UNIQUE Round flow cassette	360° air discharge for optimum efficiency and comfort > Auto cleaning function ensures high efficiency > Intelligent sensors save energy and maximize comfort > Flexibility to suit every room layout > Lowest installation height in the market! 		•	•	•	•	•	•		•	•	•				
Ceiling mounted cassette	UNIQUE Fully flat cassette	Unique design that integrates fully flat into the ceiling > Perfect integration in standard architectural ceiling tiles > Blend of iconic design and engineering excellence > Intelligent sensors save energy and maximize comfort > Small capacity unit developed for small or well-insulated rooms > Flexibility to suit every room layout 		•	•	•	•	•									
	2-way blow ceiling mounted cassette	Thin, lightweight design installs easily in narrow ceiling spaces > Depth of all units is 620mm, ideal for narrow ceiling spaces > Flexibility to suit every room layout > Reduced energy consumption thanks to DC fan motor > The flaps close entirely when the unit is not operating > Optimum comfort with automatic air flow adjustment to the required load		•	•	•	•	•	•		•		•				
	Ceiling mounted corner cassette	1-way blow unit for corner installation > Compact dimensions enable installation in narrow ceiling voids > Flexible installation thanks to different air discharge options				•	•	•	•								
	Small concealed ceiling unit	Designed for hotel rooms > Compact dimensions enable installation in narrow ceiling voids > Discretely concealed in the ceiling: only the grilles are visible > Flexible installation as the air suction direction can be altered from rear to bottom suction		•	•												
Concealed ceiling	Slim concealed ceiling unit	Slim design for flexible installation > Compact dimensions enable installation in narrow ceiling voids > Medium external static pressure up to 44Pa > Only grilles are visible > Small capacity unit developed for small of well-insulated rooms > Reduced energy consumption thanks to DC fan motor		•	•	•	•	•	•								
	Concealed ceiling unit with medium ESP	Slimmest yet most powerful medium static pressure unit on the market! > Slimmest unit in class, only 245mm > Low operating sound level > Medium external static pressure up to 150Pa facilitates using flexible ducts of varying lengths > Automatic air flow adjustment function measures the air volume and static pressure and adjusts it towards the nominal air flow, guaranteeing comfort		•	•	•	•	•	•		•	•	•	•			
	Concealed ceiling unit with high ESP	ESP up to 200, ideal for large sized spaces > Optimum comfort guaranteed no matter the length of ductwork or type of grilles, thanks to automatic air flow adjustment > Reduced energy consumption thanks to DC fan motor > Flexible installation as the air suction direction can be altered from rear to bottom suction							•	•	•	•					
	Concealed ceiling unit with high ESP	ESP up to 270, ideal for extra large sized spaces > Only grilles are visible > Large capacity unit: up to 31.5 kW heating capacity													•	•	
	Concealed ceiling unit with high efficiency	For the highest energy efficiency > Automatic air flow adjustment function guarantees comfort > Easy installation in narrow ceilings (245mm height) > High external static pressure up to 270Pa facilitates using flexible ducts of varying lengths > Only the suction and discharge grilles are visible							•	•	•	•					
	Wall mounted unit	For rooms with no false ceilings nor free floor space > Flat, stylish front panel is more easy to clean > Small capacity unit developed for small of well-insulated rooms > Reduced energy consumption thanks to DC fan motor > The air is comfortably spread up- and downwards thanks to 5 different discharge angles		•	•	•	•	•	•								
	Ceiling suspended	Ceiling suspended unit	For wide rooms with no false ceilings nor free floor space > Ideal for comfortable air flow in wide rooms thanks to Coanda effect > Rooms with ceilings up to 3.8m can be heated or cooled very easily! > Can easily be installed in both new and refurbishment projects > Can even be mounted in corners or narrow spaces without any problem > Reduced energy consumption thanks to DC fan motor					•		•			•				
UNIQUE 4-way blow ceiling suspended unit		Unique Daikin unit for high rooms with no false ceilings nor free floor space > Rooms with ceilings up to 3.5m can be heated up or cooled very easily! > Can easily be installed in both new and refurbishment projects > Flexibility to suit every room layout > Reduced energy consumption thanks to DC fan motor									•	•					
Floor standing	Floor standing unit	For perimeter zone air conditioning > Can be installed in front of glass walls or free standing as both the front and the back are finished > Ideal for installation beneath a window > Requires very little installation space > Wall mounted installation facilitates cleaning beneath the unit		•	•	•	•	•	•								
	Concealed floor standing unit	Ideal for installation in offices, hotels and residential applications > Discretely concealed in the wall, leaving only the suction and discharge grilles visible > Can even be installed underneath a window > Requires very little installation space as the depth is only 200mm > High ESP allows flexible installation		•	•	•	•	•	•								
Cooling capacity (kW) ¹			1.7	2.2	2.8	3.6	4.5	5.6	7.1	8.0	9.0	11.2	14.0	16.0	22.4	28.0	
Heating capacity (kW) ²			1.9	2.5	3.2	4.0	5.0	6.3	8.0	9.0	10.0	12.5	16.0	18.0	25.0	31.5	

(1) Nominal cooling capacities are based on: indoor temperature: 27°CDB, 19°CWB, outdoor temperature: 35°CDB, equivalent refrigerant piping: 5m, level difference: 0m

(2) Nominal heating capacities are based on: indoor temperature: 20°CDB, outdoor temperature: 7°CDB, 6°CWB, equivalent refrigerant piping: 5m, level difference: 0m

Stylish indoor units overview

Depending on the application, Split and Sky Air indoor units can be connected to our VRV IV and VRV IV S-series outdoor units. Refer to the **outdoor unit portfolio** for combination restrictions.



Type	Model	Product name	15	20	25	35	42	50	60	71	Connectable outdoor unit				
											RYYQ-T	RXYQ-T(9)	RXYSQ-TY1 ²	RXYSQ-TY1 ³	
Ceiling mounted cassette	Round flow cassette (incl. auto-cleaning function ¹)	 FCQG-F 				●		●	●				✓	✓	
	Fully flat cassette	 FFQ-C 			●	●		●	●				✓	✓	
Concealed ceiling	Small concealed ceiling unit	FDBQ-B 			●								✓	✓	
	Slim concealed ceiling unit	FDXS-F(9) 			●	●		●	●				✓	✓	
	Concealed ceiling unit with inverter-driven fan	FBQ-D 				●		●	●				✓	✓	
Wall mounted	Daikin Emura Wall mounted unit	 FTXG-LW/LS 		●	●	●		●				✓	✓	✓	✓
	Wall mounted unit	CTXS-K FTXS-K 	●	●	●	●	●	●				✓	✓	✓	✓
	Wall mounted unit	FTXS-G 							●	●		✓	✓	✓	✓
Ceiling suspended	Ceiling suspended unit	FHQ-C 				●		●	●				✓	✓	
	Nexura floor standing unit	FVXG-K 			●	●		●				✓	✓	✓	✓
Floor standing	Floor standing unit	FVXS-F 			●	●		●				✓	✓	✓	✓
	Flexi type unit	FLXS-B(9) 			●	●		●	●			✓	✓	✓	✓

¹ Decoration panel BYCQ140DG or BYCQ140DGF + BRC1E52A/B needed

² To connect stylish indoor units a BPMKS unit is needed

³ For RXYSQ units a mix of RA indoor units and VRV indoor units is not allowed.

Hydrobox range

Type	Product name	Model	Capacity class (kW)		
			80	125	Leaving water temperature range
Low temperature hydrobox	HXY-A8 	For high efficiency space heating and cooling <ul style="list-style-type: none"> > Ideal for hot or cold water in underfloor, air handling units, low temperature radiators ... > Hot/cold water from 5° to 45°C > Large operation range (down to -20°C and up to 43°C) > Fully integrated water-side components save time on system design > Space saving contemporary wall hung design 	●	●	5 °C - 45 °C
High temperature hydrobox	HXHD-A8 	For efficient hot water production and space heating <ul style="list-style-type: none"> > Ideal for hot water in bathrooms, sinks and for underfloor heating, radiators, air handling units, ... > Hot water from 25 to 80°C > "Free" heating and hot water through heat recovery > Uses heat pump technology to produce hot water efficiently, providing up to 17% savings compared to a gas boiler > Possibility to connect thermal solar collectors 		●	25 °C - 80 °C

Benefits overview **VRV**

We care		Inverter technology	In combination with inverter controlled outdoor units
		Home leave operation	During absence, indoor comfort levels can be maintained
		Fan only	The air conditioner can be used as fan, blowing air without cooling or heating
		Auto cleaning filter	The filter automatically cleans itself once a day. Simplicity of upkeep means optimum energy efficiency and maximum comfort without the need for expensive or time-consuming maintenance
		Floor and presence sensor	The presence sensor directs the air away from any person detected in the room. The floor sensor detects the average floor temperature and ensures an even temperature distribution between ceiling and floor
Comfort		Draught prevention	When starting to warm up or when the thermostat is off, the air discharge direction is set horizontally and the fan to low speed, to prevent draught. After warming up, air discharge and fan speed are set as desired
		Whisper quiet	Daikin indoor units are whisper quiet. Also the outdoor units are guaranteed not to disturb the quiet of the neighbourhood
		Auto cooling-heating changeover	Automatically selects cooling or heating mode to achieve the set temperature
Air treatment		Air filter	Removes airborne dust particles to ensure a steady supply of clean air
Humidity control		Dry programme	Allows humidity levels to be reduced without variations in room temperature
Air flow		Ceiling soiling prevention	The air discharge of the indoor unit is specially designed to prevent air being blown against the ceiling to prevent ceiling stains
		Vertical auto swing	Possibility to select automatic vertical moving of the air discharge louvre, for uniform air flow and temperature distribution
		Fan speed steps	Multiple fan speeds to select, to optimize comfort levels
		Individual flap control	Individual flap control via the wired remote controller makes it simple to fix the position of each flap individually, to suit any new room configuration. Optional closure kits are available as well
Remote control & timer		Weekly timer	Timer can be set to start and stop operation anytime on a daily or weekly basis
		Infrared remote control	Infrared remote control with LCD to remotely control your indoor unit
		Wired remote control	Wired remote control to remotely control your indoor unit
		Centralised control	Centralised control to control several indoor units from one single point
Other functions		Auto-restart	The unit restarts automatically at the original settings after power failure
		Self-diagnosis	Simplifies maintenance by indicating system faults or operating anomalies
		Drain pump kit	Facilitates condensation draining from the indoor unit
		Multi tenant	The indoor unit's main power supply can be turned off when leaving the building or for servicing purposes

FCQG-F/FCQHG-F/FXFQ-A

Round flow cassette

Why choose a round flow cassette?

- 360° air discharge for optimum efficiency and comfort in shops, offices and restaurants.
- Unique auto-cleaning panel.

Unique functions which help save costs

› Daikin was the first company to launch a cassette using the round flow principle with sensors* and a unique auto-cleaning panel*.

... More energy efficient than any other

› The auto-cleaning panel* means:

- Running costs are reduced by 50% compared with standard solutions thanks to automatic daily filter cleaning.
- Less time is required to maintain the filter: dust can be removed easily with a vacuum cleaner without opening the unit.
- For fine dust applications (i.e. clothing shops) a finer mesh filter (BYCQ140DGF) ensures consistent, optimum performance.
- Round flow cassette - overview decoration panels

BYCQ140DG	BYCQ140DGF	BYCQ140DW	BYCQ140D
Auto-cleaning panel	auto-cleaning panel with fine mesh filter	White panel	Standard panel
White with grey louvers	White with grey louvers	Full white	White with grey louvers

› Thanks to presence and floor sensors*, the unit changes its setpoint or switches off completely, if there are no people in the room, resulting in energy savings of up to 27%.

Dust can be removed easily with a vacuum cleaner without opening the unit.

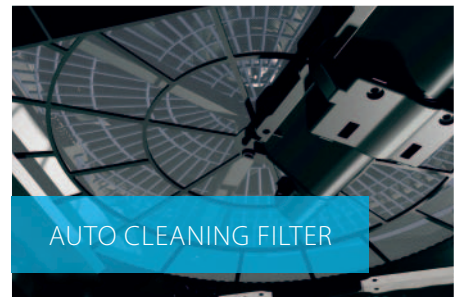
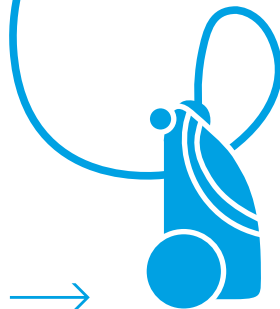
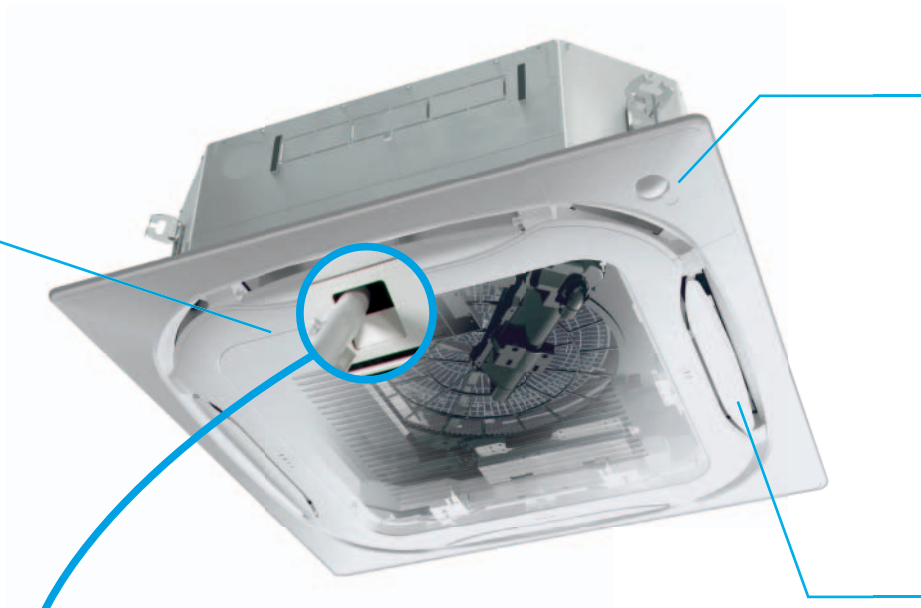

References

Wolverhampton, UK
Running costs were reduced by up to 50% compared with standard solutions thanks to daily filter cleaning.

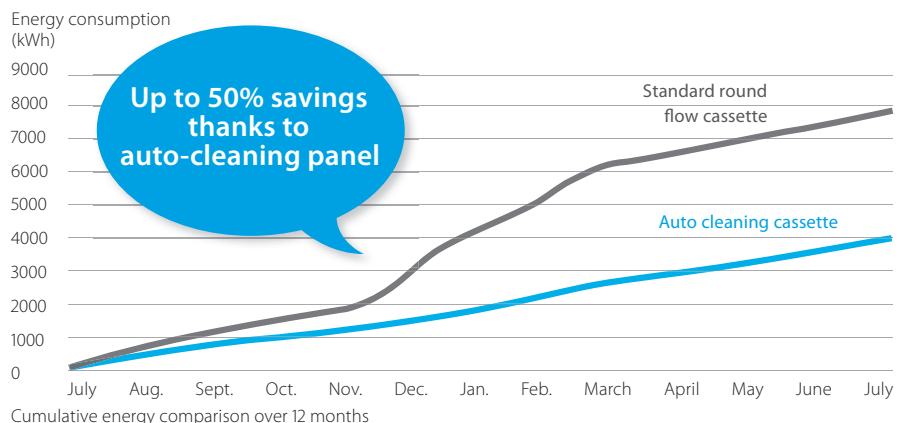



... And improved comfort

- › 360° air flow discharge pattern.
- › The presence sensor* directs the air away from anyone it detects in the room.
- › The floor sensor* detects the average floor temperature and ensures an even temperature distribution between the ceiling and the floor.



* available as an option

Flexible installation

- › Flaps can be individually controlled or closed using the wired remote control, to suit room configuration. Optional closure kits are also available.

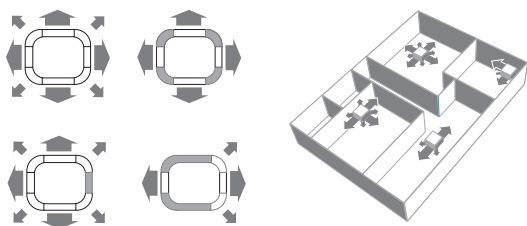

Benefits for the installer

- › Product with unique functions in this market.
- › Less time needed for onsite maintenance.
- › Use the controller to individually open or close any of the four flaps to easily adapt to a changing room layout.
- › Easy set-up of the sensor option to improve comfort and save energy.

Benefits for the consultant

- › Product with unique functions in this market.
- › Designed for use in all types and sizes of commercial offices and retail environments.
- › Ideal product for improving BREEAM score/EPDB in combination with Sky Air Seasonal Smart or VRV IV heat pump units.

Benefits for the end user

- › Designed for use in all types and sizes of commercial offices and retail environments.
- › Perfect environment conditions: no more draughts or cold feet.
- › Save up to 50% on running costs with the auto-cleaning panel, which also facilitates maintenance!
- › Your customers can save up to 27% on their energy bills thanks to the sensor option.
- › Flexible use of space thanks to individual flap control.

Marketing tools

- › Visit the website: www.daikineurope.com/minisite/round-flow-cassette/



www.youtube.com/DaikinEurope





AUTO CLEANING PANEL WITH FINE MESH FILTER, IDEAL FOR CLOTHING SHOPS



Round flow cassette

360° air discharge for optimum efficiency and comfort

- › 360° air discharge ensures uniform air flow and temperature distribution
- › Daily automatic filter cleaning results in higher efficiency & comfort and lower maintenance costs. Dust can easily be removed with a vacuum cleaner without opening the unit
- › Two optional intelligent sensors improve energy efficiency and comfort.
- › Individual flap control: flexibility to suit every room layout without changing the location of the unit.
- › Modern style decoration panel is available in 3 different variations: white (RAL9010) with grey louvers, full white (RAL9010) or auto cleaning panel
- › Reduced energy consumption thanks to specially developed small tube heat exchanger, DC fan motor and drain pump
- › Fresh air intake integrated in the same system thus reducing installation cost as no additional ventilation is required

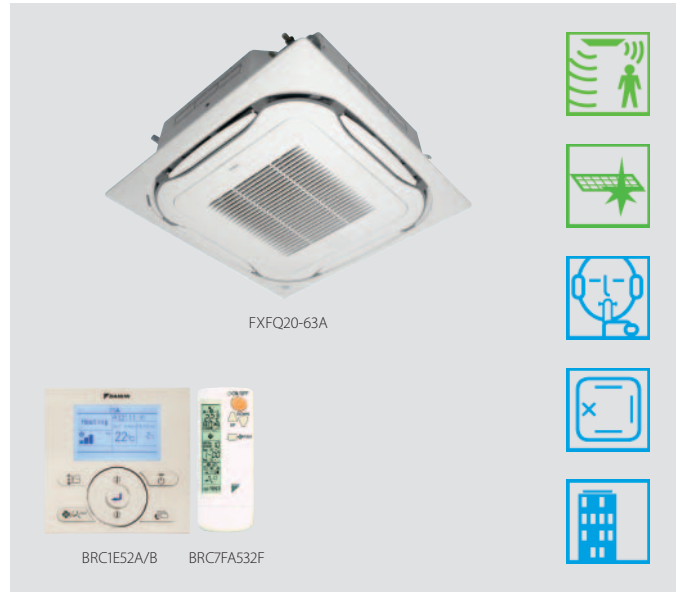

Fresh air intake opening in casing Optional fresh air intake kit



- › Branch duct discharge allows to optimize air distribution in irregular shaped rooms or to supply air to small adjacent rooms

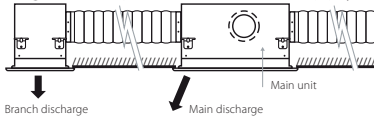

- › Lowest installation height in the market: 214mm for class 20-63
- › Standard drain pump with 850mm lift increases flexibility and installation speed

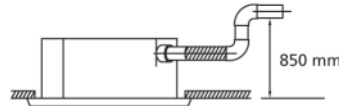

Indoor unit			FXFQ	20A	25A	32A	40A	50A	63A	80A	100A	125A									
Cooling capacity	Nom.	kW	2.2	2.8	3.6	4.5	5.6	7.1	9.0	11.2	14.0										
Heating capacity	Nom.	kW	2.5	3.2	4.0	5.0	6.3	8.0	10.0	12.5	16.0										
Power input - 50Hz	Cooling	Nom.			0.038		0.053	0.061	0.092	0.115	0.186										
	Heating	Nom.			0.038		0.053	0.061	0.092	0.115	0.186										
Dimensions	Unit	Height	mm	204			246			288											
		Width	mm	840			840														
		Depth	mm	19			20			21											
Weight	Unit	kg	19			20			21			24									
Casing	Material		Galvanised steel plate																		
Decoration panel	Model		BYCQ140D7GFW1 - auto cleaning panel with fine mesh filter																		
	Colour		Pure White (RAL 9010)																		
	Dimensions	HeightxWidthxDepth	mm	130x950x950																	
	Weight	kg	10.3																		
Decoration panel 2	Model		BYCQ140D7GW1 - auto cleaning panel																		
	Colour		Pure White (RAL 9010)																		
	Dimensions	HeightxWidthxDepth	mm	130x950x950																	
	Weight	kg	10.3																		
Decoration panel 3	Model		BYCQ140D7W1W - full white																		
	Colour		Pure White (RAL 9010)																		
	Dimensions	HeightxWidthxDepth	mm	50x950x950																	
	Weight	kg	5.4																		
Decoration panel 4	Model		BYCQ140D7W1 - white with grey louvers																		
	Colour		Pure white (RAL 9010)																		
	Dimensions	HeightxWidthxDepth	mm	50x950x950																	
	Weight	kg	5.4																		
Fan-Air flow rate - 50Hz	Cooling	High/Nom./Low	m ³ /min	12.5/10.6/8.8		13.6/11.6/9.5	15.0/12.8/10.5	16.5/13.5/10.5	22.8/17.6/12.4	26.5/19.5/12.4	33.0/26.5/19.9										
	Heating	High/Nom./Low	m ³ /min	12.5/10.6/8.8		13.6/11.6/9.5	15.0/12.8/10.5	16.5/13.5/10.5	22.8/17.6/12.4	26.5/19.5/12.4	33.0/26.5/19.9										
Air filter	Type			Resin net with mold resistance																	
				51/-			53/-			55/-			60/-			61/-					
Sound power level	Cooling	High/Nom.	dBA	49/-			51/-			53/-			55/-			60/-			61/-		
	Heating	High/Nom./Low	dBA	31/29/28			33/31/29			35/33/30			38/34/30			43/37/30			45/41/36		
Refrigerant	Type			R-410A																	
	GWP			2,087.5																	
Piping connections	Liquid	OD	mm	6.35						9.52											
	Gas	OD	mm	12.7						15.9											
	Drain			VP25 (O.D. 32 / I.D. 25)																	
Power supply	Phase/Frequency/Voltage	Hz/V	1~50/60/220-240/220																		
Current - 50Hz	Maximum fuse amps (MFA)	A	16																		
Control systems	Infrared remote control		BRC7FA532F																		
	Wired remote control		BRC1D52 / BRC1E52A/B																		
	Simplified wired remote control for hotel applications		-																		

The BYCQ140D7W1W has white insulations. Be informed that formation of dirt on white insulation is visibly stronger and that it is consequently not advised to install the BYCQ140D7W1W decoration panel in environments exposed to concentrations of dirt. | BYCQ140D7W1: pure white standard panel with grey louvers; BYCQ140D7W1W: pure white standard panel with white louvers; BYCQ140D7GFW1: pure white auto cleaning panel.



FFQ-C / FXZQ-A



Fully Flat Cassette

Design & Genius in one

Why choose fully flat cassette

- › Unique design in the market that integrates fully flat into the ceiling
- › Advanced technology and top efficiency combined
- › Most quiet cassette available on the market



www.youtube.com/DaikinEurope



Marketing tools

- › Visit the website: www.daikineurope.com/fullyflat

Benefits for the installer

- › Unique product in the market!
- › Most quiet unit (25dBA)
- › The user-friendly remote control, available in several languages, enables the easy set-up of sensor option and control of the individual flap position
- › Meeting European design taste.

Benefits for the consultant

- › Unique product in the market!
- › Blends seamlessly in any modern office interior design
- › Ideal product to improve BREEAM score/EPBD in combination with Sky Air Seasonal Smart (FFQ-C) or VRV IV heat pump units (FXZQ-A).

Benefits for the end user

- › Engineering excellence and unique design in one
- › Most quiet unit (25dBA)
- › Perfect working conditions: no more cold draughts
- › Save up to 27% on your energy bill thanks to the optional sensors
- › Flexible usage of space and suits any room configuration thanks to individual flap control
- › User-friendly remote control, available in several languages.

Unique design

- › Designed by a European design office to fully meet the European taste.
- › Fully flat into the ceiling, leaving only 8mm.
- › Fully integrated in the one ceiling tile, enabling lights, speakers and sprinklers to be installed in adjoining ceiling tiles.
- › Decoration panel available in 2 colours (white and white-silver).



Differentiating in technology

Optional presence sensor

- › When the room is empty, it can adjust the set temperature or switch off the unit – saving energy.
- › When people are detected, the direction of the airflow is adapted to avoid cold draughts being directed towards occupants.

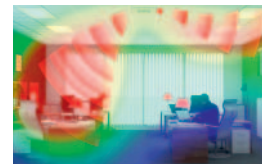

Optional floor sensor

- › Detects the temperature difference and re-directs the airflow to ensure even temperature distribution.

Top efficiency

- › Seasonal labels up to **A++***
- › When the room is empty, the sensor option can adjust the set temperature or switch off the unit – saving up to 27% energy.
- › Individual flap control: easily control one or more flaps via the wired remote controller (BRC1E52) when rearranging the room. When fully closing or blocking the flaps, the option “Sealing member of air discharge outlet” is needed.

* for FFQ25,35C in combination with RXS25,35L3



Most quiet unit in the market

- › Most silent cassette in the market (25dBA), important for office applications.

Fully flat cassette

Unique design in the market that integrates fully flat into the ceiling

- › Fully flat integration in standard architectural ceiling tiles, leaving only 8mm
- › Remarkable blend of iconic design and engineering excellence with an elegant finish in white or a combination of silver and white
- › Two optional intelligent sensors improve energy efficiency and comfort.
- › 15 class unit especially developed for small or well-insulated rooms, such as hotel bedrooms, small offices, etc.
- › Individual flap control: flexibility to suit every room layout without changing the location of the unit!

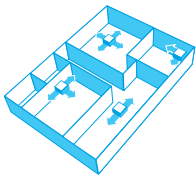

- › Reduced energy consumption thanks to specially developed small tube heat exchanger, DC fan motor and drain pump
- › Fresh air intake integrated in the same system thus reducing installation cost as no additional ventilation is required

Fresh air intake opening in casing

Optional fresh air intake kit



* Brings in up to 10% of fresh air into the room

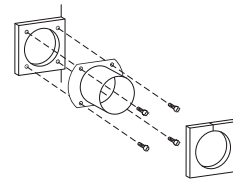

* Allows larger quantities of fresh air to be brought in

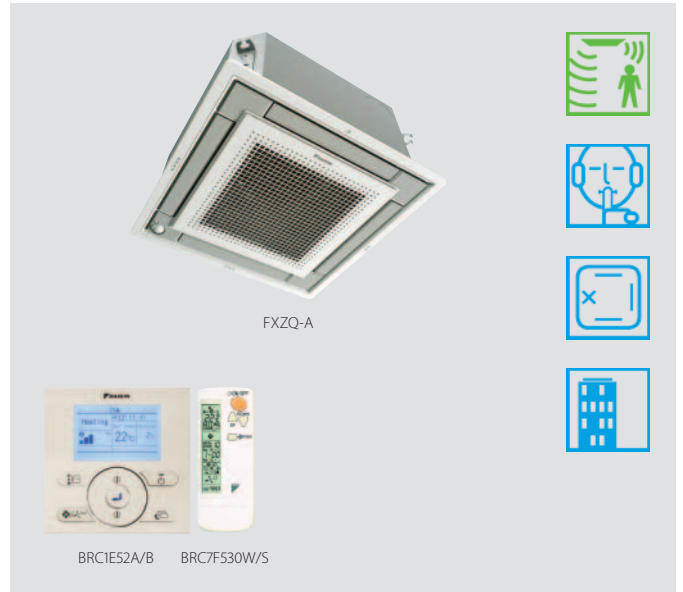

- › Branch duct discharge allows to optimize air distribution in irregular shaped rooms or to supply air to small adjacent rooms

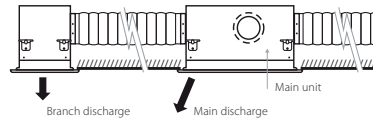

- › Standard drain pump with 630mm lift increases flexibility and installation speed

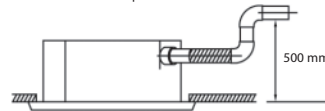

Indoor unit		FXZQ	15A	20A	25A	32A	40A	50A	
Cooling capacity	Nom.	kW	1.7	2.2	2.8	3.6	4.5	5.6	
Heating capacity	Nom.	kW	1.9	2.5	3.2	4.0	5.0	6.3	
Power input - 50Hz	Cooling	Nom.	0.043			0.045	0.059	0.092	
	Heating	Nom.	0.036			0.038	0.053	0.086	
Dimensions	Unit	Height	260						
		Width	575						
		Depth	575						
Weight	Unit	kg	15.5		16.5		18.5		
Casing	Material	Galvanised steel plate							
Decoration panel	Model	BYFQ60CW							
	Colour	White (N9.5)							
	Dimensions	HeightxWidthxDepth	46x620x620						
	Weight	kg	2.8						
Decoration panel 2	Model	BYFQ60CS							
	Colour	White (N9.5) + Silver							
	Dimensions	HeightxWidthxDepth	46x620x620						
	Weight	kg	2.8						
Decoration panel 3	Model	BYFQ60B3W1							
	Colour	White (RAL9010)							
	Dimensions	HeightxWidthxDepth	55x700x700						
	Weight	kg	2.7						
Fan-Air flow rate - 50Hz	Cooling	High/Nom./Low	m ³ /min	8.5/7/6.5	8.7/7.5/6.5	9/8/6.5	10/8.5/7	11.5/9.5/8	14.5/12.5/10
	Heating	High/Nom./Low	m ³ /min	8.5/7/6.5	8.7/7.5/6.5	9/8/6.5	10/8.5/7	11.5/9.5/8	14.5/12.5/10
Air filter	Type	Resin net with mold resistance							
Sound power level	Cooling	High/Nom.	dB(A)	49/-		50/-	51/-	54/-	60/-
Sound pressure level	Cooling	High/Nom./Low	dB(A)	31.5/28/25.5	32/29.5/25.5	33/30/25.5	33.5/30/26	37/32/28	43/40/33
	Heating	High/Nom./Low	dB(A)	31.5/28/25.5	32/29.5/25.5	33/30/25.5	33.5/30/26	37/32/28	43/40/33
Refrigerant	Type	R-410A							
	GWP	2,087.5							
Piping connections	Liquid	OD	mm	6.35					
	Gas	OD	mm	12.7					
	Drain	VP20 (I.D. 20/O.D. 26)							
Power supply	Phase/Frequency/Voltage	Hz/V	1~/50/220-240						
Current - 50Hz	Maximum fuse amps (MFA)	A	16						
Control systems	Infrared remote control	BRC7F530W (white panel) / BRC7F530S (grey panel) / BRC7EB530 (standard panel)							
	Wired remote control	BRC1D52 / BRC1E52A/B							
	Simplified wired remote control for hotel applications	-							

(1) Dimensions do not include control box (2) Contains fluorinated greenhouse gases

2-way blow ceiling mounted cassette

Thin, lightweight design installs easily in narrow corridors

- › Depth of all units is 620mm, ideal for narrow spaces
- › Individual flap control: flexibility to suit every room layout without changing the location of the unit!
- › Reduced energy consumption thanks to specially developed small tube heat exchanger, DC fan motor and drain pump
- › Stylish unit blends easily with any interior. The flaps close entirely when the unit is not operating and there are no air intake grilles visible
- › Fresh air intake integrated in the same system thus reducing installation cost as no additional ventilation device is required

Fresh air intake opening in casing



* Brings in up to 10% of fresh air into the room

- › Optimum comfort guaranteed with automatic air flow adjustment to the required load
- › Maintenance operations can be performed by removing the front panel
- › Branch duct discharge allows to optimize air distribution in irregular shaped rooms or to supply air to small adjacent rooms

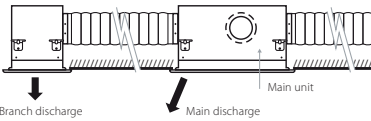

- › Standard drain pump with 580mm lift increases flexibility and installation speed

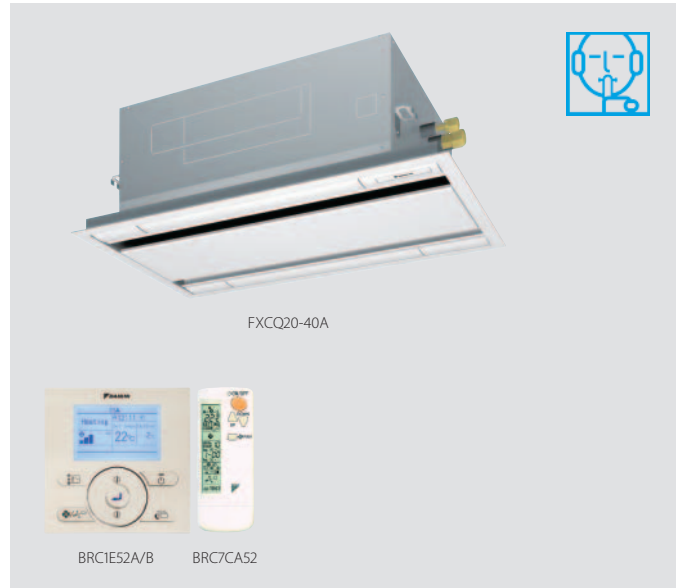
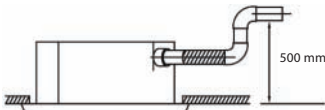

Indoor unit		FXCQ	20A	25A	32A	40A	50A	63A	80A	125A	
Cooling capacity	Nom.	kW	2.2	2.8	3.6	4.5	5.6	7.1	9.0	14.0	
Heating capacity	Nom.	kW	2.5	3.2	4.0	5.0	6.3	8.0	10.0	16.0	
Power input - 50Hz	Cooling	Nom.	0.031		0.039		0.041	0.059	0.063	0.090	
	Heating	Nom.	0.028	0.035	0.037	0.056	0.060	0.086	0.146		
Dimensions	Unit	Height	305								
		Width	775				990		1,445		
		Depth	620								
Weight	Unit	kg	19		22		25	33		38	
Casing	Material	Galvanised steel plate									
Decoration panel	Model	BYBCQ40HW1			BYBCQ63HW1			BYBCQ125HW1			
	Colour	Fresh white (6.5Y 9.5/0.5)									
	Dimensions	HeightxWidthxDepth	55x1,070x700			55x1,285x700			55x1,740x700		
	Weight	kg	10			11			13		
Fan-Air flow rate - 50Hz	Cooling	High/Nom./Low	m ³ /min	10.5/9/7.5	11.5/9.5/8		12/10.5/8.5	15/13/10.5	16/14/11.5	26/22.5/18.5 32/27.5/22.5	
Air filter	Type	Resin net with mold resistance									
Sound power level	Cooling	Nom.	dB(A)	-							
Sound pressure level	Cooling	High/Nom./Low	dB(A)	32.0/30.0/28.0	34.0/31.0/29.0	34.0/32.0/30.0	36.0/33.0/31.0	37.0/35.0/31.0	39.0/37.0/32.0	42.0/38.0/33.0 46.0/42.0/38.0	
	Heating	High/Nom./Low	dB(A)	32.0/30.0/28.0	34.0/31.0/29.0	34.0/32.0/30.0	36.0/33.0/31.0	37.0/35.0/31.0	39.0/37.0/32.0	42.0/38.0/33.0 46.0/42.0/38.0	
Refrigerant	Type	R-410A									
	GWP	2,087.5									
Piping connections	Liquid	OD	mm	6.35				9.52			
	Gas	OD	mm	12.7				15.9			
	Drain	VP25 (O.D. 32 / I.D. 25)									
Power supply	Phase/Frequency/Voltage	Hz/V	1~/50/220-240								
Current - 50Hz	Maximum fuse amps (MFA)	A	16								
Control systems	Infrared remote control	BRC7C52									
	Wired remote control	BRC1D52 / BRC1E52A/B									
	Simplified wired remote control for hotel applications	-									

(1) Contains fluorinated greenhouse gases

Ceiling mounted corner cassette

1-way blow unit for corner installation

- › Compact dimensions, can easily be mounted in a narrow ceiling void (only 220mm ceiling space required, 195 with panel spacer, available as accessory)
- › Optimum air flow conditions are created by either downward air discharge or frontal air discharge (via optional grille) or a combination of both

Downward discharge



Frontal discharge

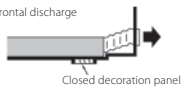

Combination

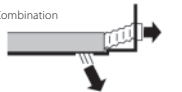

- › Maintenance operations can be performed by removing the front panel
- › Standard drain pump with 330mm lift increases flexibility and installation speed

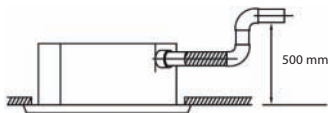

Indoor unit		FXKQ	25MA	32MA	40MA	63MA
Cooling capacity	Nom.	kW	2.8	3.6	4.5	7.10
Heating capacity	Nom.	kW	3.2	4.0	5.0	8.00
Power input - 50Hz	Cooling	Nom.		0.066		0.105
	Heating	Nom.		0.046		0.085
Dimensions	Unit	Height	mm			215
		Width	mm			1,110
		Depth	mm			710
Weight	Unit	kg	31			34
Casing	Material	Galvanised steel plate				
Decoration panel	Model	BYK45FJW1			BYK71FJW1	
	Colour	White				
	Dimensions	HeightxWidthxD	mm			70x1,240x800
	Weight	kg	8.5			9.5
Fan-Air flow rate - 50Hz	Cooling	High/Low	m ³ /min		11/9	13/10
Air filter	Type	Resin net with mold resistance				
Sound power level	Cooling	Nom.	dBA			-
Sound pressure level	Cooling	High/Low	dBA		38.0/33.0	40.0/34.0
Refrigerant	Type	R-410A				
	GWP	2,087.5				
Piping connections	Liquid	OD	mm			6.35
	Gas	OD	mm			12.7
	Drain	VP25 (O.D. 32 / I.D. 25)				
Power supply	Phase/Frequency/Voltage	Hz/V	1~/50/60/220-240/220			
Current - 50Hz	Maximum fuse amps (MFA)	A	15			
Control systems	Infrared remote control	BRC4C61				
	Wired remote control	BRC1D52 / BRC1E52A/B				
	Simplified wired remote control for hotel applications	-				

(1) Contains fluorinated greenhouse gases

Small concealed ceiling unit

Designed for hotel applications

- › Compact unit (230mm high & 652mm deep), can easily be mounted in narrow ceiling voids
- › Discretely concealed in the ceiling: only the suction and discharge grilles are visible
- › Flexible installation, as the air suction direction can be altered from rear to bottom suction

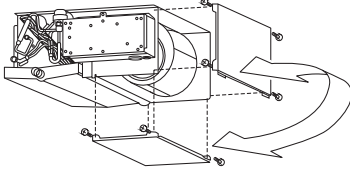

- › For easy mounting, the drain pan can be located to the left or right of the unit

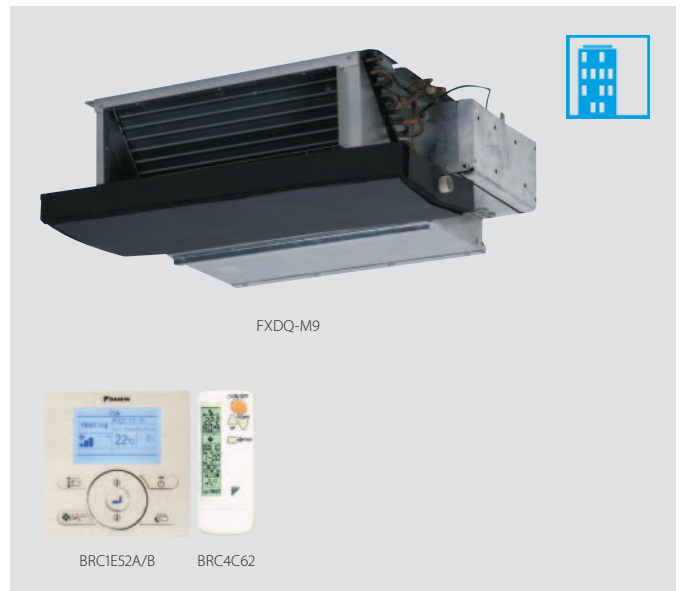
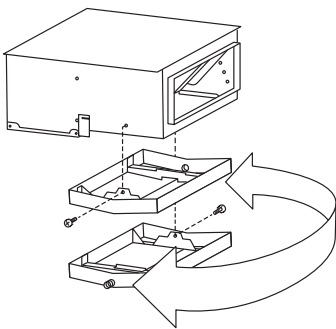

Indoor unit		FXDQ	20M9	25M9
Cooling capacity	Nom.	kW	2.2	2.8
Heating capacity	Nom.	kW	2.5	3.2
Power input - 50Hz	Cooling	Nom.		0.050
	Heating	Nom.		0.050
Dimensions	Unit	Height	mm	230
		Width	mm	502
		Depth	mm	652
Required ceiling void >			mm	250
Weight	Unit	kg	17	
Casing	Colour		Unpainted	
	Material		Galvanised steel	
Fan-Air flow rate - 50Hz	Cooling	High/Low	m ³ /min	6.7/5.2
	Heating	High/Low	m ³ /min	6.7/5.2
Air filter	Type		Resin net with mold resistance	
Sound power level	Cooling	Nom.	dB(A)	50
Sound pressure level	Cooling	High/Low	dB(A)	37/32
	Heating	High/Low	dB(A)	37/32
Refrigerant	Type		R-410A	
	GWP		2,087.5	
Piping connections	Liquid	OD	mm	6.35
	Gas	OD	mm	12.7
	Drain			I.D. 21.6, O.D. 27.2
Power supply	Phase/Frequency/Voltage	Hz/V	1~/50/230	
Current - 50Hz	Maximum fuse amps (MFA)	A	16	
Control systems	Infrared remote control		BRC4C62	
	Wired remote control		BRC1D52 / BRC1E52A/B	
	Simplified wired remote control for hotel applications		BRC2E52C (heat recovery type) / BRC3E52C (heat pump type)	

(1) Contains fluorinated greenhouse gases

Slim concealed ceiling unit

Slim design for flexible installation

- › Compact dimensions, can easily be mounted in a ceiling void of only 240mm

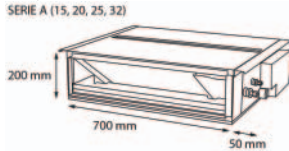

- › Medium external static pressure up to 44Pa facilitates unit use with flexible ducts of varying lengths
- › Discretely concealed in the ceiling: only the suction and discharge grilles are visible
- › 15 class unit especially developed for small or well-insulated rooms, such as hotel bedrooms, small offices, etc.
- › Reduced energy consumption thanks to specially developed DC fan motor
- › Flexible installation, as the air suction direction can be altered from rear to bottom suction

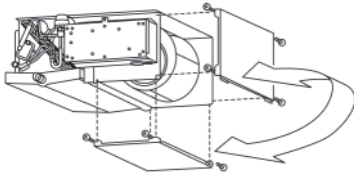

- › Standard drain pump with 750mm lift increases flexibility and installation speed

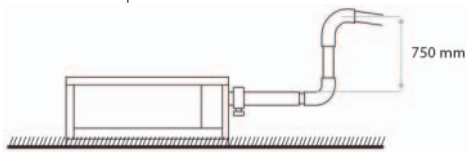

Indoor unit		FXDQ	15A	20A	25A	32A	40A	50A	63A	
Cooling capacity	Nom.	kW	1.7	2.2	2.8	3.6	4.5	5.6	7.1	
Heating capacity	Nom.	kW	1.9	2.5	3.2	4.0	5.0	6.3	8.0	
Power input - 50Hz	Cooling	Nom.	0.071				0.078		0.110	
	Heating	Nom.	0.068				0.075		0.107	
Dimensions	Unit	Height	mm				200			
		Width	mm				750		950	
		Depth	mm				620		1,150	
Required ceiling void >		mm					240			
Weight	Unit	kg	22				26		29	
Casing	Colour		Galvanised steel / Non painted							
Fan-Air flow rate - 50Hz	Cooling	High/Nom./Low	m ³ /min	7.5/7.0/6.4		8.0/7.2/6.4		10.5/9.5/8.5		12.5/11.0/10.0
				16.5/14.5/13.0						
Fan-External static pressure - 50Hz	High/Nom.	Pa	30/10				44/15			
Air filter	Type		Removable / washable / mildew proof							
Sound power level	Cooling	Nom.	50	51		52		53	54	
Sound pressure level	Cooling	High/Nom./Low	32/31/27	33/31/27		34/32/28		35/33/29	36/34/30	
Refrigerant	Type		R-410A							
	GWP		2,087.5							
Piping connections	Liquid	OD	mm		9.52					
	Gas	OD	mm		12.7		15.9			
	Drain		VP20 (I.D. 20/O.D. 26)							
Power supply	Phase/Frequency/Voltage	Hz/V	1~/50/60/220-240/220							
Current - 50Hz	Maximum fuse amps (MFA)	A	16							
Control systems	Infrared remote control		BRC4C65							
	Wired remote control		BRC1D52 / BRC1E52A/B							
	Simplified wired remote control for hotel applications		BRC2E52C (heat recovery type) / BRC3E52C (heat pump type)							

(1) Contains fluorinated greenhouse gases

Concealed ceiling unit with medium ESP

Slimmest yet most powerful medium static pressure unit on the market

- › Slimmest unit in class, only 245mm (300mm built-in height) and therefore narrow ceiling voids are no longer a challenge



- › Whisper quiet operation: down to 25dBA sound pressure level
- › Medium external static pressure up to 150Pa facilitates using flexible ducts of varying lengths
- › Possibility to change ESP via wired remote control allows optimisation of the supply air volume
- › Discretely concealed in the wall: only the suction and discharge grilles are visible
- › 15 class unit especially developed for small or well-insulated rooms, such as hotel bedrooms, small offices, etc.
- › Reduced energy consumption thanks to specially developed DC fan motor and drain pump
- › Fresh air intake integrated in the same system thus reducing installation cost as no additional ventilation is required

Fresh air intake opening in casing



* Brings in up to 10% of fresh air into the room

Optional fresh air intake kit

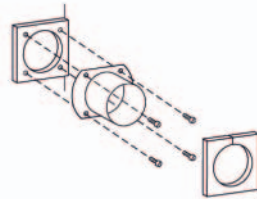

* Allows larger quantities of fresh air to be brought in

- › Flexible installation: air suction direction can be altered from rear to bottom suction and choice between free use or connection to optional suction grilles

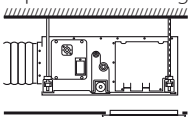

For free use into a false ceiling

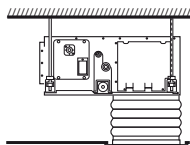

For connecting onto a suction canvas (not supplied by Daikin)

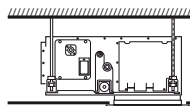

For direct connection to Daikin panel (via EKBYBSD kit)

- › Standard built-in drain pump with 625mm lift increases flexibility and installation speed

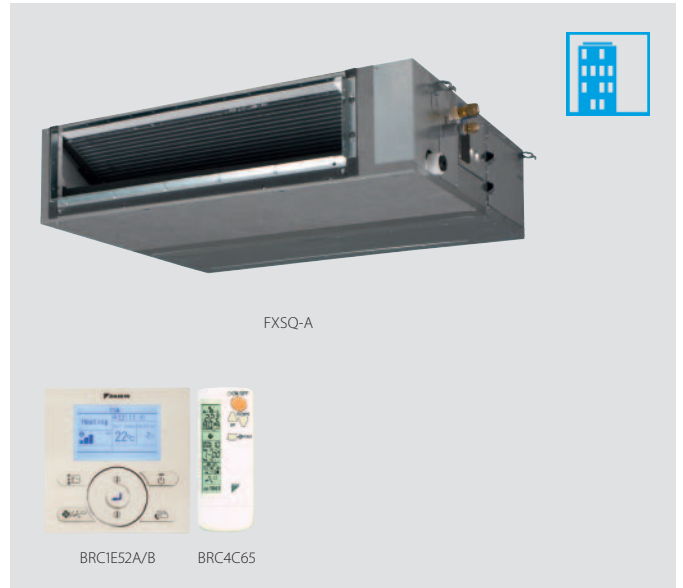
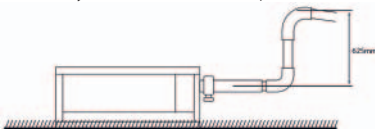

FXSQ-A

BRC1E52A/B

BRC4C65

Automatic Airflow Adjustment function

Automatically selects the most appropriate fan curve to achieve the units' nominal air flow within ±10%

Why?

After installation the real ducting will frequently differ from the initially calculated air flow resistance → the real air flow may be much lower or higher than nominal, leading to a lack of capacity or uncomfortable air temperature

Automatic Airflow Adjustment function will adapt the unit's fan speed to any ducting automatically (10 or more fan curves are available on every model), making installation much faster

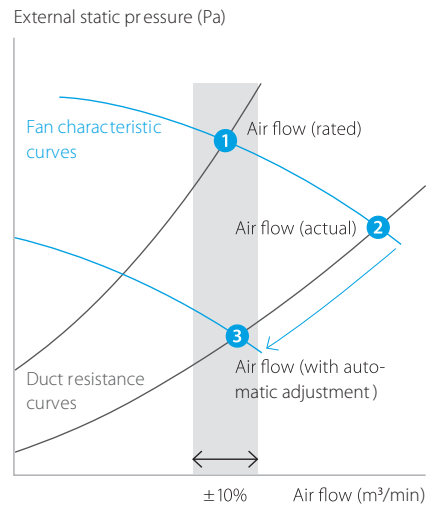

Indoor unit				FXSQ	15A	20A	25A	32A	40A	50A	63A	80A	100A	125A	140A			
Cooling capacity	Nom.		kW	1.7	2.2	2.8	3.6	4.5	5.6	7.1	9.0	11.2	14.0	16.0				
Heating capacity	Nom.		kW	1.9	2.5	3.2	4.0	5.0	6.3	8.0	10.0	12.5	16.0	18.0				
Power input - 50Hz	Cooling	Nom.	kW	0.041			0.045	0.092	0.095		0.121	0.157	0.214	0.243				
	Heating	Nom.	kW	0.038			0.042	0.089	0.092		0.118	0.154	0.211	0.240				
Dimensions	Unit	Height	mm	245														
		Width	mm	550			700			1,000			1,400			1,550		
		Depth	mm	800														
Weight	Unit		kg	23.5			24	28.5	29	35.5	36.5	46	47	51				
Casing	Colour			Not painted (galvanised)														
	Material			Galvanised steel plate														
Fan-Air flow rate - 50Hz	Cooling	High/Nom./Low	m³/min	8.7/7.5/6.5	9/7.5/6.5	9.5/8/7.0	15/12.5/11	15.2/12.5/11	21.0/18/15	23/19.5/16	32/27/23	36/31.5/26	39/34/28					
	Heating	High/Nom./Low	m³/min	8.7/7.5/6.5	9/7.5/6.5	9.5/8/7	15/12.5/11	15.2/12.5/11	21/18/15	23/19.5/16.0	32/27/23	36/31.5/26	39/34/28					
Fan-External static pressure - 50Hz	High/Nom.		Pa	150/30							150/40			150/50				
Air filter	Type			Resin net with mold resistance														
Sound power level	Cooling	Nom.	dBA	54			55	60	59	61			64					
Sound pressure level	Cooling	High/Nom./Low	dBA	29.5/28/25	30/28/25	31/29/26	35/32/29	33/30/27	35/32/29	36/34/31	39/36/33	41.5/38/34						
	Heating	High/Nom./Low	dBA	31.5/29/26	32/29/26	33/30/27	37/34/29	35/32/28	37/34/30	37/34/31	40/37/33	42/38.5/34						
Refrigerant	Type			R-410A														
	GWP			2,087.5														
Piping connections	Liquid	OD	mm	6.35							9.52							
	Gas	OD	mm	12.7							15.9							
	Drain			VP20 (I.D. 20/O.D. 26)														
Power supply	Phase/Frequency/Voltage		Hz/V	1~50/60/220-240/220														
Current - 50Hz	Maximum fuse amps (MFA)		A	16														
Control systems	Infrared remote control			BRC4C65														
	Wired remote control			BRC1D52 / BRC1E52A/B														
	Simplified wired remote control for hotel applications			BRC2E52C (heat recovery type) / BRC3E52C (heat pump type)														

Concealed ceiling unit with high ESP

Ideal for large sized spaces

FXMQ-P7: ESP up to 200 Pa

- › Possibility to change ESP via wired remote control allows optimisation of the supply air volume
- › High external static pressure up to 200Pa facilitates extensive duct and grille network
- › Discretely concealed in the wall: only the suction and discharge grilles are visible
- › Reduced energy consumption thanks to specially developed DC fan motor
- › Fresh air intake integrated in the same system thus reducing installation cost as no additional ventilation device is required

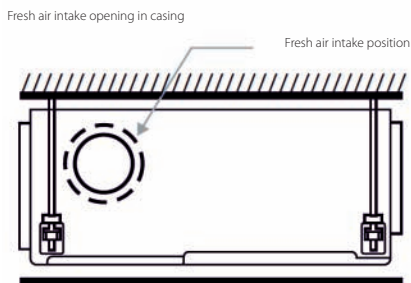

- › Flexible installation, as the air suction direction can be altered from rear to bottom suction

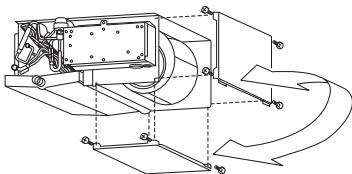

- › Standard built-in drain pump with 625mm lift increases flexibility and installation speed

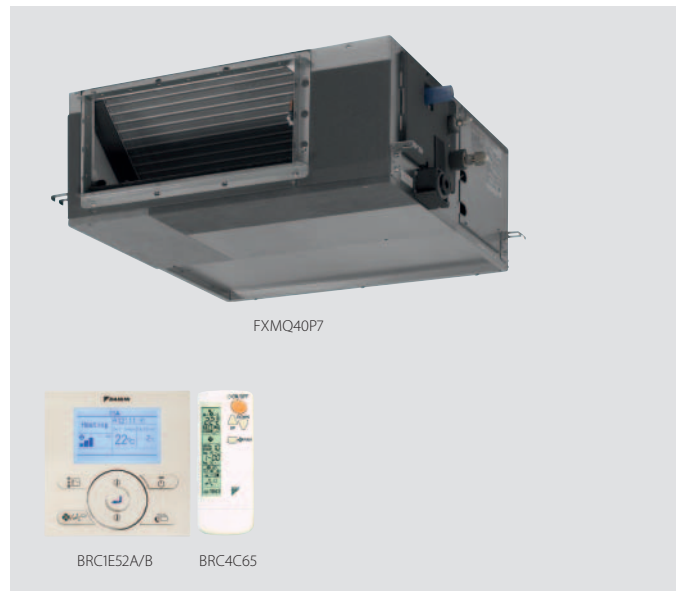
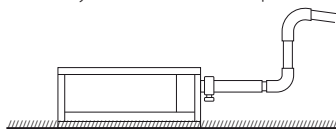

FXMQ-MB: ESP up to 270

- › High external static pressure up to 270Pa facilitates extensive duct and grille network
- › Discretely concealed in the wall: only the suction and discharge grilles are visible
- › Large capacity unit: up to 31.5 kW heating capacity
- › Reduced energy consumption thanks to specially developed DC fan motor

Automatic Airflow Adjustment function

Automatically selects the most appropriate fan curve to achieve the units' nominal air flow within ±10%

Why?

After installation the real ducting will frequently differ from the initially calculated air flow resistance → the real air flow may be much lower or higher than nominal, leading to a lack of capacity or uncomfortable air temperature

Automatic Airflow Adjustment function will adapt the unit's fan speed to any ducting automatically (10 or more fan curves are available on every model), making installation much faster

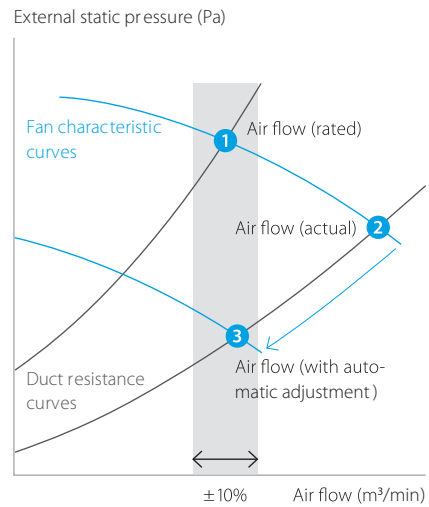

Indoor unit		FXMQ-P7/FXMQ-MB		50P7	63P7	80P7	100P7	125P7	200MB	250MB
Cooling capacity	Nom.		kW	5.6	7.1	9.0	11.2	14.0	22.4	28.0
Heating capacity	Nom.		kW	6.3	8.0	10.0	12.5	16.0	25.0	31.5
Power input - 50Hz	Cooling	Nom.	kW	0.110	0.120	0.171	0.176	0.241	0.895	1.185
	Heating	Nom.	kW	0.098	0.108	0.159	0.164	0.229	0.895	1.185
Dimensions	Unit	Height	mm	300					470	
		Width	mm	1,000			1,400		1,380	
		Depth	mm	700					1,100	
Required ceiling void >			mm	350					-	
Weight	Unit		kg	35			46		132	
Casing	Colour			Unpainted					-	
	Material			Galvanised steel plate					-	
Decoration panel	Model			BYBS71DJW1			BYBS125DJW1		-	
	Colour			White (10Y9/0.5)					-	
	Dimensions	HeightxWidthxDepth	mm	55x1,100x500			55x1,500x500		-x-x-	
	Weight		kg	4.5			6.5		-	
Fan-Air flow rate - 50Hz	Cooling	High/Nom./Low	m³/min	18/16.5/15	19.5/17.8/16	25/22.5/20	32/27.5/23	39/33.5/28	58/54.0/50	72/67.0/62
	Heating	High/Nom./Low	m³/min	18/16.5/15	19.5/17.8/16	25/22.5/20	32/27.5/23	39/33.5/28	-/-	
Fan-External static pressure - 50Hz	High/Nom.		Pa	200/100					270/160	270/170
Air filter	Type			Resin net with mold resistance					-	
Sound power level	Cooling	High/Nom.	dBA	61/-	64/-	67/-	65/-	70/-	-/-	
Sound pressure level	Cooling	High/Nom./Low	dBA	41/39/37	42/40/38	43/41/39		44/42/40	48/-/45	
	Heating	High/Nom./Low	dBA	41/39/37	42/40/38	43/41/39		44/42/40	-/-	
Refrigerant	Type			R-410A					-	
	GWP			2,087.5					-	
Piping connections	Liquid	OD	mm	6.35	9.52				-	
	Gas	OD	mm	12.7	15.9			19.1	22.2	
	Drain			VP25 (I.D. 25/O.D. 32)					PS1B	
Power supply	Phase/Frequency/Voltage		Hz/V	1~/50/60/220-240/220					1~/50/220-240	
Current - 50Hz	Maximum fuse amps (MFA)		A	16					-	
Control systems	Infrared remote control			BRC4C65					-	
	Wired remote control			BRC1D52 / BRC1E52A/B					-	
	Simplified wired remote control for hotel applications			BRC2E52C (heat recovery type) / BRC3E52C (heat pump type)					-	

Concealed ceiling unit with high efficiency

For the highest energy efficiency

- › Automatic air flow adjustment function measures the air volume and static pressure and adjusts it towards the nominal air flow, whatever the length of duct, making installation easier and guaranteeing comfort. Moreover, the ESP can be changed via the wired remote control to optimize the supply air volume (for 50 and 63 class)
- › Narrow ceilings voids are no longer a challenge, 50 & 60 class units can swiftly be integrated as they only are 245mm in height.
- › High external static pressure up to 270Pa facilitates using flexible ducts of varying lengths
- › Discretely concealed in the ceiling: only the suction and discharge grilles are visible

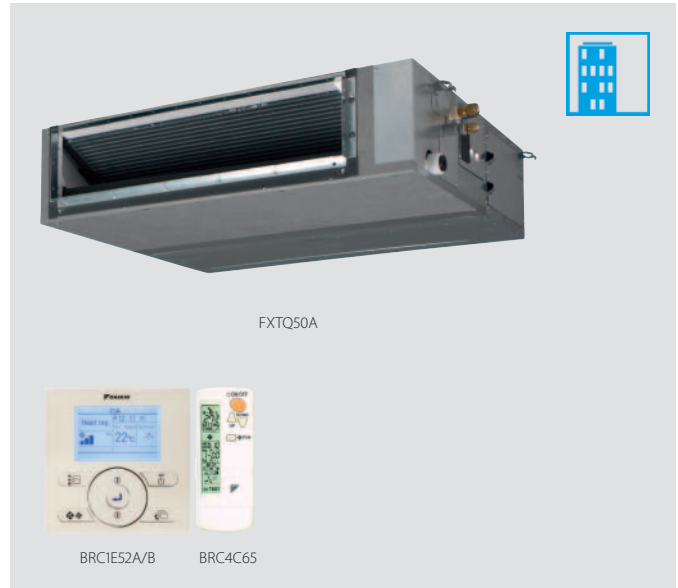

Indoor unit		FXTQ	50A	63A	80A	100A	
Cooling capacity	Nom.	kW	5.6	7.1	8.7	11.2	
Heating capacity	Nom.	kW	6.3	8	10.0	12.5	
Power input - 50Hz	Cooling	Nom.	0.214	0.243	1.294	1.465	
	Heating	Nom.	0.211	0.240	1.294	1.465	
Dimensions	Unit	Height	245		470		
		Width	1,400	1,550	1,380		
		Depth	800		1,100		
Weight	Unit	kg	47	51	137		
Casing	Material	Galvanised steel plate					
Fan-Air flow rate - 50Hz	Cooling	High/Low	m ³ /min	36/26	39/28	58/50	72/62
	External static pressure - 50Hz	High/Nom.	Pa	150/50	140/50	221/132	270/191
Sound power level	Cooling	Nom.	dBA	-			
Sound pressure level	Cooling	High/Low	dBA	39/33	42/34	48/45	
Refrigerant	Type	R-410A					
	GWP	2,087.5					
Piping connections	Liquid	OD	mm	9.52			
	Gas	OD	mm	15.9	19.1	22.2	
	Drain			VP20	PS1B		
Power supply	Phase/Frequency/Voltage	Hz/V	1~/50/60/220-240/220				
Current - 50Hz	Maximum fuse amps (MFA)	A	16	15			
Control systems	Infrared remote control	BRC4C65					
	Simplified wired remote control for hotel applications	BRC2E52C (heat recovery) / BRC3E52C (heat pump)					
	Wired remote control	BRC1D52 / BRC1E52A/B					

(1) Only connectable to REYQ8-16T, RYYQ8-16T, RXYQ8-16T(9)

Wall mounted unit

For rooms with no false ceilings nor free floor space

- › Flat, stylish front panel blends easily within any interior décor and is easier to clean
- › Can easily be installed in both new and refurbishment projects
- › 15 class unit especially developed for small or well-insulated rooms, such as hotel bedrooms, small offices, etc.
- › Reduced energy consumption thanks to specially developed DC fan motor
- › The air is comfortably spread up- and downwards thanks to 5 different discharge angles that can be programmed via the remote control
- › Maintenance operations can be performed easily from the front of the unit



Indoor unit				FXAQ	15P	20P	25P	32P	40P	50P	63P
Cooling capacity	Nom.		kW	1.7	2.2	2.8	3.6	4.5	5.6	7.1	
Heating capacity	Nom.		kW	1.9	2.5	3.2	4.0	5.0	6.3	8.0	
Power input - 50Hz	Cooling	Nom.	kW	0.017	0.019	0.028	0.030	0.020	0.033	0.050	
	Heating	Nom.	kW	0.025	0.029	0.034	0.035	0.020	0.039	0.060	
Dimensions	Unit	Height	mm	290							
		Width	mm	795				1,050			
		Depth	mm	238							
Weight	Unit		kg	11					14		
Casing	Colour			White (3.0Y8.5/0.5)							
Fan-Air flow rate - 50Hz	Cooling	High/Low	m ³ /min	7.0/4.5	7.5/4.5	8/5	8.5/5.5	12/9	15/12	19/14	
				Washable resin net							
Air filter	Type			Washable resin net							
Sound power level	Cooling	High/Nom.	dBA	52.0/-	53.0/-	54.0/-	55.5/-	57.0/-	60.0/-	65.0/-	
Sound pressure level	Cooling	High/Low	dBA	34.0/29.0	35.0/29.0	36.0/29.0	37.5/29.0	39.0/34.0	42.0/36.0	47.0/39.0	
Refrigerant	Type			R-410A							
	GWP			2,087.5							
Piping connections	Liquid	OD	mm	6.35							9.52
	Gas	OD	mm	12.7							15.9
	Drain			VP13 (I.D. 13/O.D. 18)							
Power supply	Phase/Frequency/Voltage		Hz/V	1~/50/220-240							
Current - 50Hz	Maximum fuse amps (MFA)		A	16							
Control systems	Infrared remote control			BRC7EB518							
	Wired remote control			BRC1E52A/B / BRC1D52							
	Simplified wired remote control for hotel applications			-							

Ceiling suspended unit

For wide rooms with no false ceilings nor free floor space

- › Ideal for comfortable air flow in wide rooms thanks to Coanda effect: up to 100° discharge angle

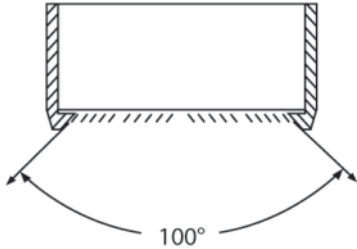

- › Even rooms with ceilings up to 3.8m can be heated up or cooled down very easily without capacity loss
- › Can easily be installed in both new and refurbishment projects
- › Can easily be mounted in corners and narrow spaces, as it only needs 30mm lateral service space

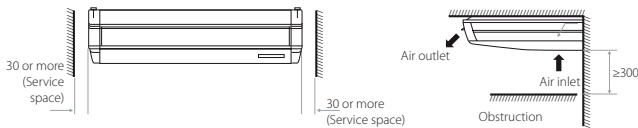

- › Fresh air intake integrated in the same system thus reducing installation cost as no additional ventilation device is required

Fresh air intake opening in casing

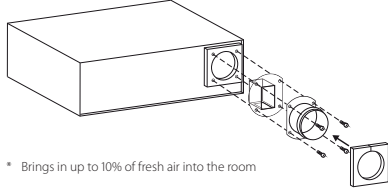

* Brings in up to 10% of fresh air into the room



- › Reduced energy consumption thanks to specially developed DC fan motor and drain pump
- › Stylish unit blends easily with any interior. The flaps close entirely when the unit is not operating and there are no air intake grilles visible

Indoor unit			FXHQ	32A	63A	100A
Cooling capacity	Nom.		kW	3.6	7.1	11.2
Heating capacity	Nom.		kW	4.0	8.0	12.5
Power input - 50Hz	Cooling	Nom.	kW	0.107	0.111	0.237
	Heating	Nom.	kW	0.107	0.111	0.237
Dimensions	Unit	Height	mm		235	
		Width	mm	960	1,270	1,590
		Depth	mm		690	
Weight	Unit		kg	24	33	39
Casing	Colour			Fresh White		
	Material			Resin		
Fan-Air flow rate - 50Hz	Cooling	High/Nom./Low	m ³ /min	14.0/12.0/10.0	20.0/17.0/14.0	29.5/24.0/19.0
	Heating	High/Nom./Low	m ³ /min	14.0/12.0/10.0	20.0/17.0/14.0	29.5/24.0/19.0
Air filter	Type			Resin net with mold resistance		
Sound power level	Cooling	Nom.	dB(A)		-	
Sound pressure level	Cooling	High/Nom./Low	dB(A)	36.0/34.0/31.0	37.0/35.0/34.0	44.0/37.0/34.0
	Heating	High/Nom./Low	dB(A)	36.0/34.0/31.0	37.0/35.0/34.0	44.0/37.0/34.0
Refrigerant	Type			R-410A		
	GWP			2,087.5		
Piping connections	Liquid	OD	mm	6.35		9.52
	Gas	OD	mm	12.7		15.9
	Drain			VP20 (I.D. 20/O.D. 26)		
Power supply	Phase/Frequency/Voltage		Hz/V	1~/50/220-240		
Current - 50Hz	Maximum fuse amps (MFA)		A	16		
Control systems	Infrared remote control			BRC7G53		
	Wired remote control			BRC1E52A/B / BRC1D52		
	Simplified wired remote control for hotel applications			-		

(1) Contains fluorinated greenhouse gases

4-way blow ceiling suspended unit

Unique Daikin unit for high rooms with no false ceilings nor free floor space

- › Even rooms with ceilings up to 3.5m can be heated up or cooled down very easily without capacity loss
- › Can easily be installed in both new and refurbishment projects
- › Individual flap control: flexibility to suit every room layout without changing the location of the unit!

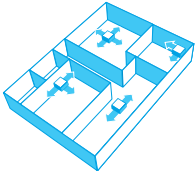

- › Reduced energy consumption thanks to specially developed small tube heat exchanger, DC fan motor and drain pump
- › Stylish unit blends easily with any interior. The flaps close entirely when the unit is not operating and there are no air intake grilles visible
- › Optimum comfort guaranteed with automatic air flow adjustment to the required load
- › 5 different discharge angles between 0 and 60° can be programmed via the remote control

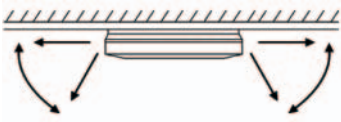

- › Standard drain pump with 500mm lift increases flexibility and installation speed

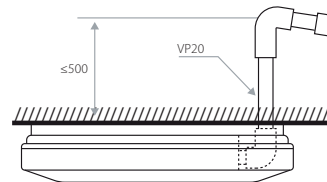

Indoor unit			FXUQ	71A	100A
Cooling capacity	Nom.		kW	8.0	11.2
Heating capacity	Nom.		kW	9.0	12.5
Power input - 50Hz	Cooling	Nom.	kW	0.090	0.200
	Heating	Nom.	kW	0.073	0.179
Dimensions	Unit	Height	mm	198	
		Width	mm	950	
		Depth	mm	950	
Weight	Unit		kg	26	27
Casing	Colour			Fresh White	
	Material			Resin	
Fan-Air flow rate - 50Hz	Cooling	High/Nom./Low	m ³ /min	22.5/19.5/16.0	31.0/26.0/21.0
	Heating	High/Nom./Low	m ³ /min	22.5/19.5/16.0	31.0/26.0/21.0
Air filter	Type			Resin net with mold resistance	
Sound power level	Cooling	Nom.	dB(A)	-	
Sound pressure level	Cooling	High/Nom./Low	dB(A)	40.0/38.0/36.0	47.0/44.0/40.0
	Heating	High/Nom./Low	dB(A)	40.0/38.0/36.0	47.0/44.0/40.0
Refrigerant	Type			R-410A	
	GWP			2,087.5	
Piping connections	Liquid	OD	mm	9.52	
	Gas	OD	mm	15.9	
	Drain			I.D. 20/O.D. 26	
Power supply	Phase/Frequency/Voltage		Hz/V	1~/50/60/220-240/220-230	
Current - 50Hz	Maximum fuse amps (MFA)		A	16	
Control systems	Infrared remote control			BRC7C58	
	Wired remote control			BRC1E52A/B / BRC1D52	
	Simplified wired remote control for hotel applications			-	

(1) Contains fluorinated greenhouse gases

Concealed floor standing unit

Designed to be concealed in walls

- › Discretely concealed in the wall: only the suction and discharge grilles are visible
- › Requires very little installation space as the depth is only 200mm



- › Its low height (620 mm) enables the unit to fit perfectly beneath a window
- › High ESP allows flexible installation

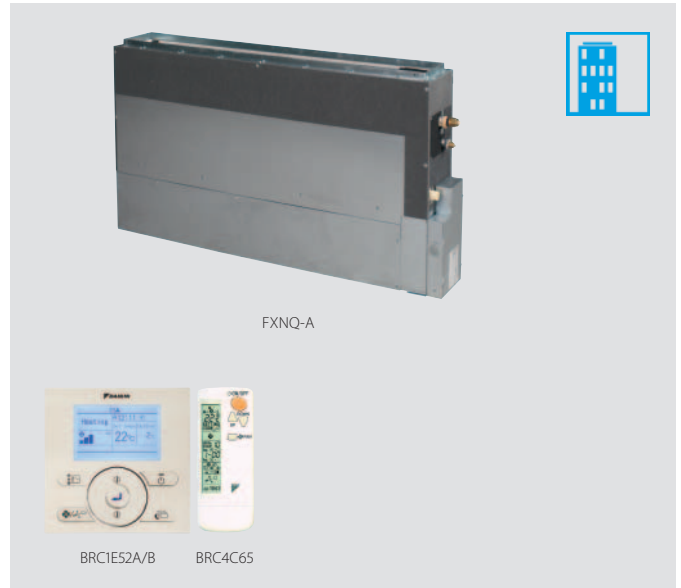

Indoor unit				FXNQ	20A	25A	32A	40A	50A	63A
Cooling capacity	Nom.		kW		2.2	2.8	3.6	4.5	5.6	7.1
Heating capacity	Nom.		kW		2.5	3.2	4.0	5.0	6.3	8.00
Power input - 50Hz	Cooling	Nom.	kW		0.071			0.078	0.099	0.110
	Heating	Nom.	kW		0.068			0.075	0.096	0.107
Dimensions	Unit	Height	mm	620 / 720 (1)						
		Width	mm	750			950			1,150
		Depth	mm	200						
Weight	Unit		kg	23.5			27.5			32
Casing	Colour			Unpainted						
	Material			Galvanised steel plate						
Fan-Air flow rate - 50Hz	Cooling	High/Nom./Low	m ³ /min	8.0/7.2/6.4			10.5/9.5/8.5	12.5/11/10.0	16.5/14.5/13.0	
	Heating	High/Nom./Low	m ³ /min	8.0/7.2/6.4			10.5/9.5/8.5	12.5/11/10.0	16.5/14.5/13.0	
Fan-External static pressure - 50Hz	High/Nom.		Pa	41/10		42/10	52/15	59/15	55/15	
Air filter	Type			Resin net with mold resistance						
Sound power level	Cooling	High/Nom.	dBA	51/-			52/-	53/-	54/-	
Sound pressure level	Cooling	High/Nom./Low	dBA	30/28.5/27			32/30/28	33/31/29	35/33/32	
	Heating	High/Nom./Low	dBA	30/28.5/27			32/30/28	33/31/29	35/33/32	
Refrigerant	Type			R-410A						
	GWP			2,087.5						
Piping connections	Liquid	OD	mm	6.35			9.52			
	Gas	OD	mm	12.7			15.9			
	Drain			VP20 (I.D. 20/O.D. 26)						
Power supply	Phase/Frequency/Voltage		Hz/V	1~/50/60/220-240/220						
Current - 50Hz	Maximum fuse amps (MFA)		A	16						
Control systems	Infrared remote control			BRC4C65						
	Wired remote control			BRC1D52 / BRC1D61 / BRC1E52A/B						
	Simplified wired remote control for hotel applications			BRC2E52C (heat recovery type) / BRC3E52C (heat pump type)						

(1) Including installation legs (2) Contains fluorinated greenhouse gases

Floor standing unit

For perimeter zone air conditioning

- › Unit can be installed as free standing model by use of optional back plate
- › Its low height enables the unit to fit perfectly beneath a window
- › Stylish modern casing finished in pure white (RAL9010) and iron grey (RAL7011) blends easily with any interior
- › Requires very little installation space

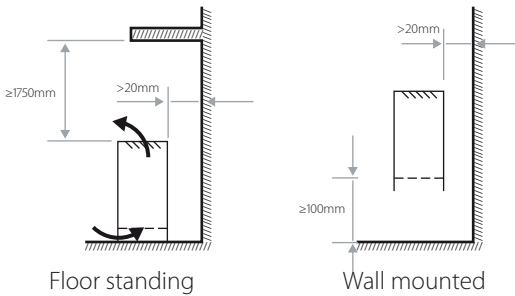

- › Wall mounted installation facilitates cleaning beneath the unit where dust tends to accumulate



- › Wired remote control can easily be integrated in the unit

Indoor unit		FXLQ	20P	25P	32P	40P	50P	63P
Cooling capacity	Nom.	kW	2.2	2.8	3.6	4.5	5.6	7.1
Heating capacity	Nom.	kW	2.5	3.2	4.0	5.0	6.3	8.000
Power input - 50Hz	Cooling	Nom.	0.049		0.090		0.110	
	Heating	Nom.	0.049		0.090		0.110	
Dimensions	Unit	Height	600					
		Width	1,000		1,140		1,420	
		Depth	232					
Weight	Unit	kg	27		32		38	
Casing	Colour	Fresh white (RAL9010) / Dark grey (RAL7011)						
Fan-Air flow rate - 50Hz	Cooling	High/Low	7/6		8/6	11/8.5	14/11	16/12
	Air filter	Type	Resin net					
Sound power level	Cooling	Nom.	dBA					
Sound pressure level	Cooling	High/Low	35/32		38/33	39/34	40/35	
	Heating	High/Low	35/32		38/33	39/34	40/35	
Refrigerant	Type	R-410A						
	GWP	2,087.5						
Piping connections	Liquid	OD	mm		6.35		9.52	
	Gas	OD	mm		12.7		15.9	
	Drain	O.D. 21 (Vinyl chloride)						
Power supply	Phase/Frequency/Voltage		Hz/V		1~/50/60/220-240/220			
Current - 50Hz	Maximum fuse amps (MFA)		A		15			
Control systems	Infrared remote control		BRC4C65					
	Wired remote control		BRC1D52 / BRC1E52A/B					
	Simplified wired remote control for hotel applications		BRC2E52C (heat recovery type) / BRC3E52C (heat pump type)					

Low temperature hydrobox for VRV

For high efficiency space heating and cooling

- › Air to water connection to VRV for applications such as underfloor, air handling units, low temperature radiators, ...
- › Leaving water temperature range from 5°C to 45°C without electric heater
- › Super wide operating range for hot/cold water production from -20 to +43°C ambient outdoor temperature
- › Saves time on system design as all water-side components are fully integrated with direct control over leaving water temperature
- › Space saving contemporary wall hung design
- › No gas connection or oil tank needed
- › Connectable to VRV IV heat pump and heat recovery

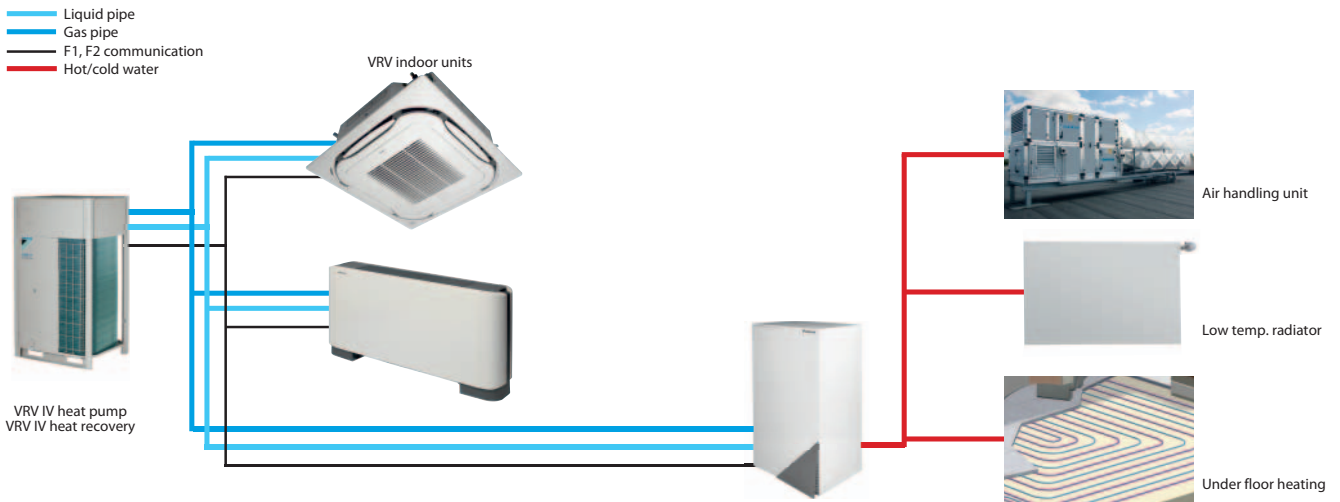

Indoor unit		HXY		080A8		125A8	
Cooling capacity	Nom.			8.0		12.5	
Heating capacity	Nom.			9.00		14.00	
Dimensions	Unit	HeightxWidthxDepth		890x480x344			
Weight	Unit			44			
Casing	Colour	White					
	Material	Precoated sheet metal					
Sound pressure level	Nom.			-			
Operation range	Heating	Ambient	Min.-Max.	-20~24			
		Water side	Min.-Max.	25~45			
	Domestic hot water	Ambient	Min.-Max.	N/A			
		Water side	Min.-Max.	N/A			
Refrigerant	Type / GWP	R-410A / 2.087,5					
Refrigerant circuit	Gas side diameter			15.9			
	Liquid side diameter			9.5			
Water circuit	Piping connections diameter			G 1"1/4 (female)			
Power supply	Phase/Frequency/Voltage			1~/50/220-240			
Current	Recommended fuses			6~16			

Contains fluorinated greenhouse gases

High temperature hydrobox for VRV

For efficient hot water production and space heating

- › Air to water connection to VRV for applications such as bathrooms, sinks, underfloor heating, radiators and air handling units
- › Leaving water temperature range from 25 to 80°C without electric heater
- › „Free“ heating and hot water production provided by transferring heat from areas requiring cooling to areas requiring heating or hot water
- › Uses heat pump technology to produce hot water efficiently, providing up to 17% savings compared to a gas boiler
- › Possibility to connect thermal solar collectors to the domestic hot water tank
- › Super wide operating range for hot water production from -20 to +43°C ambient outdoor temperature
- › Saves time on system design as all water-side components are fully integrated with direct control over leaving water temperature
- › Various control possibilities with weather dependant set point or thermostat control
- › The indoor unit and domestic hot water tank can be stacked to save space, or installed next to each other, if only limited height is available
- › No gas connection or oil tank needed
- › Connectable to VRV IV heat recovery

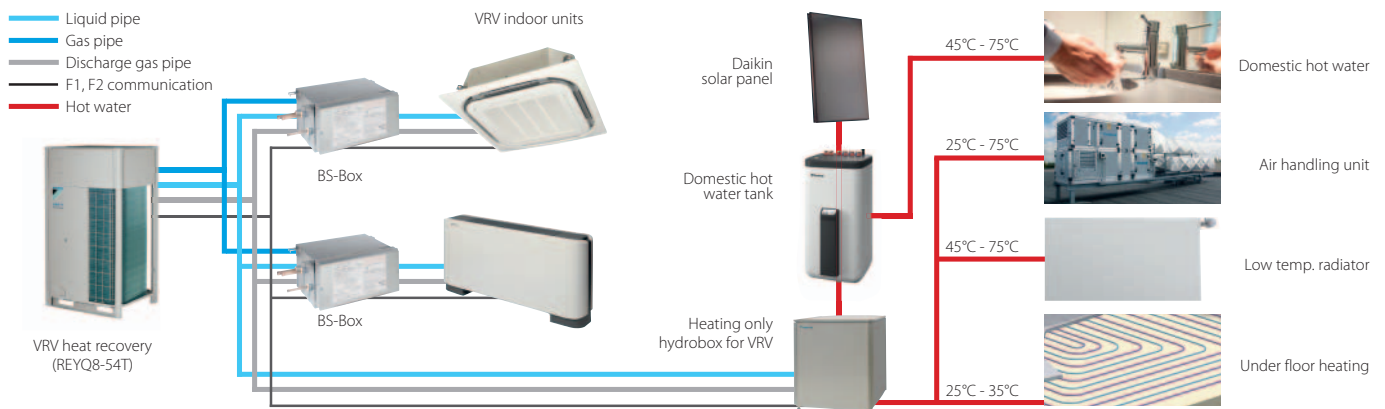

Indoor unit		HXHD		125A8		
Heating capacity	Nom.	kW		14.0		
Dimensions	Unit	HeightxWidthxDepth		705x600x695		
Weight	Unit	kg		92		
Casing	Colour	Metallic grey				
	Material	Precoated sheet metal				
Sound pressure level	Nom.	dBA		42 (1) / 43 (2)		
	Night quiet mode	Level 1	dBA	38 (1)		
Operation range	Heating	Ambient	Min.~Max.	°C	-20~-20 / 24 (3)	
		Water side	Min.~Max.	°C	25~80	
	Domestic hot water	Ambient	Min.~Max.	°CDB	-20~43	
		Water side	Min.~Max.	°C	45~75	
Refrigerant	Type / GWP	R-134a / 1.430				
Refrigerant circuit	Gas side diameter		mm	12.7		
	Liquid side diameter		mm	9.52		
	Piping connections diameter		inch	G 1" (female)		
Water circuit	Heating water system		Water volume	Max.~Min.	l	200~20
	Phase/Frequency/Voltage		Hz/V	1~/50/220-240		
Current	Recommended fuses		A	20		

(1) Sound levels are measured at: EW 55°C; LW 65°C (2) Sound levels are measured at: EW 70°C; LW 80°C (3) Field setting (4) Contains fluorinated greenhouse gases

Domestic hot water tank

Stackable stainless steel domestic hot water tank

- › The indoor unit and domestic hot water tank can be stacked to save space, or installed next to each other, if only limited height is available
- › Available in 200 and 260 liters
- › Heat loss is reduced to a minimum thanks to the high quality insulation
- › At necessary intervals, the indoor unit can heat up the water to 60°C to prevent the risk of bacteria growth
- › Efficient temperature heat-up: from 10°C to 50°C in only 60 minutes



Accessory		EKHTS		200AC	260AC
Casing	Colour	Metallic grey			
	Material	Galvanised steel (precoated sheet metal)			
Dimensions	Unit	Height	Integrated on indoor unit	2,010	2,285
		Width			
	Depth	695			
Weight	Unit	Empty	kg	70	78
	Tank	Water volume	l	200	260
Heat exchanger	Material	Stainless steel (EN 1.4521)			
	Maximum water temperature	°C			
	Insulation	Heat loss	kWh/24h	1.2	1.5
	Quantity	1			
Heat exchanger	Tube material	Duplex steel (EN 1.4162)			
	Face area	m ²			
	Internal coil volume	l			

EKHWP-B

Domestic hot water tank

Plastic domestic hot water tank with solar support

- › Available in 300 and 500 liters
- › Large hot water storage tank to provide domestic hot water at any time
- › Heat loss is reduced to a minimum thanks to the high quality insulation
- › Space heating support possible (500l tank only)
- › Tank designed for connection with pressured thermal solar system



Accessory		EKHWP		Pressured		Unpressured		
				300PB	500PB	300B	500B	
Dimensions	Unit	Width	mm	595	790	595	790	
		Depth	mm	615	790	615	790	
Weight	Unit	Empty	kg	58	89	59	93	
	Tank	Water volume	l	294	477	300	500	
Heat exchanger	Maximum water temperature	°C						
	Insulation	Heat loss	kWh/24h	1.5	1.7	1.3	1.4	
	Domestic hot water	Tube material	Stainless steel (DIN 1.4404)				Stainless steel	
		Face area	m ²	5,600	5,800	5.8	6	
Charging	Internal coil volume	l	27.1	29.0	27.9	29		
	Operating pressure	bar	6					
	Average specific thermal output	W/K	2,790	2,825	2,790	2,900		
	Tube material	Stainless steel (DIN 1.4404)						
Auxiliary solar heating	Face area	m ²	3	4	2.7	3.8		
	Internal coil volume	l	13	19	13.2	18.5		
	Operating pressure	bar	3					
	Average specific thermal output	W/K	1,300	1,800	1,300	1,800		
Auxiliary solar heating	Tube material	Stainless steel (DIN 1.4404)						
	Face area	m ²	-	1	-	0.5		
	Internal coil volume	l	-	2	-	2.3		
	Operating pressure	bar	3					
Average specific thermal output	W/K	-	280	-	280			

Pump station

- › Save energy and reduce CO₂ emissions with a solar system for domestic hot water production
- › Pump station connectable to unpressurised solar system
- › Pump station and control provide the transfer of solar heat to the domestic hot water tank



Pump station for pressureless tank				EKS SRPS4A	
Dimensions	Unit	HeightxWidthxDepth	mm	815x142x230	
Weight	Unit		kg	6	
Power supply	Phase			1~	
	Frequency		Hz	50	
	Voltage		V	230	

EKS(V/H)-P

Solar collector

Thermal solar collector for hot water production

- › Solar collectors can produce up to 70% of the energy needed for hot water production - a major cost saving
- › Vertical and horizontal solar collectors for domestic hot water production
- › High efficiency collectors transfer all the short-wave solar radiation into heat as a result of their highly selective coating
- › Easy to install on roof tiles



Solar collector				EKS V21P		EKS V26P		EKS H26P	
Mounting				Vertical				Horizontal	
Dimensions	Unit	HeightxWidthxDepth	mm	1,006x85x2,000				2,000x85x1,300	
Weight	Unit		kg	33		42			
Volume			l	1.3		1.7		2.1	
Surface	Outer		m ²	2.01		2.60			
	Aperture		m ²	1.800		2.360			
	Absorber		m ²	1.79		2.35			
Coating				Micro-therm (absorption max. 96%, Emission ca. 5% +/-2%)					
Absorber				Harp-shaped copper pipe register with laser-welded highly selective coated aluminium plate					
Glazing				Single pane safety glass, transmission +/- 92%					
Allowed roof angle Min.-Max.				15~80					
Operating pressure Max.				6					
Stand still temperature Max.				192					
Thermal performance	collector efficiency (η _{col})			61					
	Zero loss collector efficiency η ₀			0.781				0.784	
	Heat loss coefficient a ₁			4.240				4.250	
	Temperature dependence of the heat loss coefficient a ₂			0.006				0.007	
	Thermal capacity			4.9				6.5	

	VRV IV Heat Recovery				
	REYQ 8~12T	REYQ 14~20T	REMQ5T	2-module systems	3-module systems
Multi-module connection kit (obligatory) - Connects multiple modules into a single refrigerant system	-	-	-	BHFQ23P907	BHFQ23P1357
Extended level difference kit - Allows outdoor unit to be more than 50m above indoor units	Special order unit				
Central drain pan kit - Installs onto the underside of the outdoor unit and collects drain water from all bottom plate outlets into a single outlet. In cold areas should be heated by a field-supplied heater to prevent drain water from freezing in the drain pan.	-	-	-	-	-
Heater tape kit - Optional electrical heater to guarantee trouble-free operation in extremely cold and humid climates (one per outdoor unit needed)	EKBPH012T + EKBHPCBT	EKBPH020T + EKBHPCBT	EKBPH012T + EKBHPCBT	-	-
External control adapter for outdoor unit - Allows to activate Low Noise Operation and three levels of Demand Limiting via external dry contacts. Connects to the F1/F2 communication line and requires power supply from an indoor unit*, BSVQ box, or VRV-WIII outdoor unit.	DTA104A53/61/62 For installation into an indoor unit: exact adapter type depends on type of indoor unit. See Options & Accessories of indoor units				
BHGP26A1 Digital pressure gauge kit – displays current condensing and evaporating pressures in the system as standard, or expansion valve positions and temperature sensor data in a special service mode. Connect to the outdoor unit PCB, for installation in the outdoor unit.	•	•	•	1 kit per system	1 kit per system
KRC19-26A Mechanical cool/heat selector – allows to switch an entire Heat Pump system, or one BS-box of a Heat Recovery system between cooling, heating and fan only. Connects to the A-B-C terminals of the outdoor unit / BS-box.	-	-	-	-	-
EBRP2B - Cool/heat selector PCB	-	-	-	-	-
BRP2A81 Cool/heat selector PCB (required to connect KRC19-26A to VRV IV outdoor)	-	-	-	-	-
KKSA26A560* Cool/heat selector PCB mounting plate (only required when cool/heat selector PCB and Heater tape kit are combined)	-	-	-	-	-
KJB111A Installation box for remote cool/heat selector KRC19-26A	-	-	-	-	-
EKCHSC - Cool/heat selector cable	-	-	-	-	-
EKPCCAB3 VRV configurator	•	•	•	•	•
BPMKS967A2/A3 Branch provider (for connection of 2/3 RA indoor units)	-	-	-	-	-
EKDK04 Drain plug kit	-	-	-	-	-
DTA104A61/62* Demand PCB allowing external input to limit power consumption	-	-	-	-	-
KKSB2B61* Demand PCB mounted plate. Needed to mount Demand PCB for some outdoor units.	-	-	-	-	-
DTA109A51 DIII-net expander adapter	•	•	•	•	•

	VRV IV S-series			
	RXYSQ-Q-T	RXYSQ4-6TV1	RXYSQ4-6TY1	RXYSQ8-12TY1
Multi-module connection kit (obligatory) - Connects multiple modules into a single refrigerant system	-	-	-	-
Extended level difference kit - Allows outdoor unit to be more than 50m above indoor units	-	-	-	-
Central drain pan kit - Installs onto the underside of the outdoor unit and collects drain water from all bottom plate outlets into a single outlet. In cold areas should be heated by a field-supplied heater to prevent drain water from freezing in the drain pan.	-	-	-	-
Heater tape kit - Optional electrical heater to guarantee trouble-free operation in extremely cold and humid climates (one per outdoor unit needed)	-	-	-	-
External control adapter for outdoor unit - Allows to activate Low Noise Operation and three levels of Demand Limiting via external dry contacts. Connects to the F1/F2 communication line and requires power supply from an indoor unit*, BSVQ box, or VRV-WIII outdoor unit.	DTA104A53/61/62 For installation into an indoor unit: exact adapter type depends on type of indoor unit. See Options & Accessories of indoor units			
BHGP26A1 Digital pressure gauge kit – displays current condensing and evaporating pressures in the system as standard, or expansion valve positions and temperature sensor data in a special service mode. Connect to the outdoor unit PCB, for installation in the outdoor unit.	-	-	-	-
KRC19-26A Mechanical cool/heat selector – allows to switch an entire Heat Pump system, or one BS-box of a Heat Recovery system between cooling, heating and fan only. Connects to the A-B-C terminals of the outdoor unit / BS-box.	-	•	-	-
EBRP2B - Cool/heat selector PCB	-	•	-	-
BRP2A81 Cool/heat selector PCB (required to connect KRC19-26A to VRV IV outdoor)	-	-	-	-
KKSA26A560* Cool/heat selector PCB mounting plate (only required when cool/heat selector PCB and Heater tape kit are combined)	-	-	-	-
KJB111A Installation box for remote cool/heat selector KRC19-26A	-	•	-	-
EKCHSC - Cool/heat selector cable	-	-	•	•
EKPCCAB3 VRV configurator	•	•	•	•
BPMKS967A2/A3 Branch provider (for connection of 2/3 RA indoor units)	•	•	•	•
EKDK04 Drain plug kit	-	•	•	-
DTA104A61/62* Demand PCB allowing external input to limit power consumption	-	-	-	-
KKSB2B61* Demand PCB mounted plate. Needed to mount Demand PCB for some outdoor units.	-	-	-	-
DTA109A51 DIII-net expander adapter	-	-	-	-

VRV IV with continuous heating						VRV IV without continuous heating			
RYYQ8-12T	RYYQ14-20T	RYMQ8-12T	RYMQ14-20T	2-module systems	3-module systems	RXYQ8-12T (9)	RXYQ14-20T	2-module systems	3-module systems
-	-	-	-	BHFQ22P1007	BHFQ22P1517	-	-	BHFQ22P1007	BHFQ22P1517
-	-	-	-	-	-	-	-	-	-
-	-	-	-	-	-	-	-	-	-
EKBPH012T + EKBPHPCBT	EKBPH020T + EKBPHPCBT	EKBPH012T + EKBPHPCBT	EKBPH020T + EKBPHPCBT	-	-	EKBPH012T + EKBPHPCBT	EKBPH020T + EKBPHPCBT	-	-
DTA104A53/61/62 For installation into an indoor unit: exact adapter type depends on type of indoor unit. See Options & Accessories of indoor units									
•	•	•	•	1 kit per system	1 kit per system	•	•	1 kit per system	1 kit per system
•	•	•	•	•	•	•	•	•	•
-	-	-	-	-	-	-	-	-	-
•	•	•	•	•	•	•	•	•	•
•	•	•	•	•	•	•	•	•	•
•	•	•	•	•	•	•	•	•	•
-	-	-	-	-	-	-	-	-	-
•	•	•	•	•	•	•	•	•	•
•	•	-	-	-	-	•	•	-	-
-	-	-	-	-	-	-	-	-	-
•	•	•	•	•	•	•	•	•	•
-	•	-	•	-	-	-	•	-	-
•	•	•	•	•	•	•	•	•	•

VRV IV i-series SB.RKXYQ		VRV III-C Cold Region VRV			VRV Classic		
RDXYQ	RKXYQ	RTSYQ 10PA	RTSYQ 14~16PA	RTSYQ 20PA	RXYCQ8A	RXYCQ10-14A	RXYCQ16-20A
-	-	-	-	BHFQ22P1007	-	-	-
-	-	-	-	-	-	-	-
-	-	KWC26B280	KWC26B450	2x KWC26B280	KWC26B160	KWC26B280	KWC26B450
EKDPRH1RDX	-	BEH22A10Y1L	BEH22A18Y1L	2x BEH22A10Y1L	-	-	-

DTA104A53/61/62
For installation into an indoor unit: exact adapter type depends on type of indoor unit.
See Options & Accessories of indoor units

-	-	•	•	•	•	•	•
-	•	-	-	-	•	•	•
-	-	-	-	-	-	-	-
-	-	-	-	-	-	-	-
-	-	-	-	-	-	-	-
-	•	-	-	-	•	•	•
-	•	-	-	-	-	-	-
-	•	-	-	-	-	-	-
•	•	-	-	-	-	-	-
-	-	-	-	-	-	-	-
-	-	•	•	•	•	•	•

		VRV IV-Q Heat Pump Replacement VRV					
		RQYQ 140P	RXYQQ8-12T	RXYQQ14-20T	2-module systems	3-module systems	
Multi-module connection kit (obligatory) Connects multiple modules into a single refrigerant system		-	-	-	BHFQ22P1007	BHFQ22P1517	
Central drain pan kit - Installs onto the underside of the outdoor unit and collects drain water from all bottom plate outlets into a single outlet. In cold areas should be heated by a field-supplied heater to prevent drain water from freezing in the drain pan.		KWC26B160	-	-	-	-	
Heater tape kit - Optional electrical heater to guarantee trouble-free operation in extremely cold and humid climates (one per outdoor unit needed)		-	EKBPH012T + EKBPHPCBT	EKBPH020T + EKBPHPCBT	-	-	
External control adapter for outdoor unit - Allows to activate Low Noise Operation and three levels of Demand Limiting via external dry contacts. Connects to the F1/F2 communication line and requires power supply from an indoor unit*, BSVQ box, or VRV-WIII outdoor unit.		DTA104A53/61/62 For installation into an indoor unit: exact adapter type depends on type of indoor unit. See Options & Accessories of indoor units					
BHGP26A1 Digital pressure gauge kit – displays current condensing and evaporating pressures in the system as standard, or expansion valve positions and temperature sensor data in a special service mode. Connect to the outdoor unit PCB, for installation in the outdoor unit.		•	•	•	1 kit per system	1 kit per system	
KRC19-26A Mechanical cool/heat selector – allows to switch an entire Heat Pump system, or one BS-box of a Heat Recovery system between cooling, heating and fan only. Connects to the A-B-C terminals of the outdoor unit / BS-box.		•	•	•	1 kit per system	1 kit per system	
BRP2A81 Cool/heat selector PCB (required to connect KRC19-26A to VRV IV outdoor)		-	•	•	•	•	
KKSA26A560* - Cool/heat selector PCB mounting plate (only required when cool/heat selector PCB and Heater tape kit are combined)		-	-	•	•	•	
KJB111A Installation box for remote cool/heat selector KRC19-26A		•	•	•	1 kit per system	1 kit per system	
EKPCCAB3 VRV configurator		-	•	•	•	•	
DTA104A61/62* Demand PCB allowing external input to limit power consumption		-	•	•	•	•	
KKSB2B61* Demand PCB mounted plate. Needed to mount Demand PCB for some outdoor units.		-	-	•	-	-	
DTA109A51 DIII-net expander adapter		•	•	•	•	•	
		Refnet Joints				Refnet Headers	
		Capacity index < 201	Capacity index 201~290	Capacity index 291~640	Capacity index > 640	Capacity index < 291	Capacity index 291~640
Heat Recovery systems (3-pipe)	Metric-size connections	KHRQM23M20T	KHRQM23M29T	KHRQM23M64T	KHRQM23M75T	KHRQM23M29H	KHRQM23M64H
	Imperial-size connections	KHRQ23M20T	KHRQ23M29T9	KHRQ23M64T	KHRQ23M75T	KHRQ23M29H	KHRQ23M64H
	Sound reduction kit (sound insulation)	-	-	-	-	-	-
	Mechanical cool/heat selector – allows to switch an entire Heat Pump system, or one BS-box of a Heat Recovery system between cooling, heating and fan only. Connects to the A-B-C terminals of the outdoor unit / BS-box.	-	-	-	-	-	-
	Installation box for remote cool/heat selector KRC19-26	-	-	-	-	-	-
	Closed pipe kit	-	-	-	-	-	-
	Joint kit	-	-	-	-	-	-
Quiet kit	-	-	-	-	-	-	
Heat Pump systems (2-pipe)	Metric-size connections	KHRQM22M20T	KHRQM22M29T	KHRQM22M64T	KHRQM22M75T	KHRQM22M29H	KHRQM22M64H
	Imperial-size connections	KHRQ22M20T	KHRQ22M29T9	KHRQ22M64T	KHRQ22M75T	KHRQ22M29H	KHRQ22M64H

VRV III-Q Heat Recovery Replacement VRV				VRV-W IV Water-cooled VRV				
RQEQ 140~212	2-module systems	3-module systems	4-module systems	RWEYQ8-10T8	Heat Pump application		Heat Recovery application	
					2-module systems	3-module systems	2-module systems	3-module systems
-	BHFP26P36C	BHFP26P63C	BHFP26P84C	-	BHFQ22P1007	BHFQ22P1517	BHFQ23P907	BHFQ23P1357
KWC26B160	1 kit per module	1 kit per module	1 kit per module	-	-	-	-	-
-	-	-	-	-	-	-	-	-

DTA104A53/61/62

Installation in the RWEYQ outdoor unit possible. For installation in indoor units, use appropriate type (DTA104A53/61/62) for particular indoor unit. See Options & Accessories of indoor units

•	1 kit per system	1 kit per system	1 kit per system	-	-	-	-	-
-	-	-	-	•	1 kit per system	1 kit per system	-	-
-	-	-	-	•	1 kit per system	1 kit per system	-	-
-	-	-	-	-	-	-	-	-
-	-	-	-	•	1 kit per system	1 kit per system	-	-
-	-	-	-	•	•	•	•	•
-	-	-	-	-	-	-	-	-
-	-	-	-	-	-	-	-	-
•	•	•	•	•	•	•	•	•

Capacity index > 640	Heat Recovery Branch Selector Boxes (BS-Boxes)									
	1-port	1-port	4-port	4-port	6-port	6-port	8-port	10-port	12-port	16-port
KHRQM23M75H	-	-	-	-	-	-	-	-	-	-
KHRQ23M75H	BS1Q-A	BSVQ-P8B	BS4Q14A	BSV4Q100PV	BS6Q14A	BSV6Q100PV	BS8Q14A	BS10Q14A	BS12Q14A	BS16Q14A
-	EKBSVQLNP	EKBSVQLNP	-	-	-	-	-	-	-	-
-	-	KRC19-26	-	KRC19-26 1 kit per port necessary	-	KRC19-26 1 kit per port necessary	-	-	-	-
-	-	KJB111A	-	KJB111A	-	KJB111A	-	-	-	-
-	-	-	KHFP26A100C	-	KHFP26A100C	-	KHFP26A100C	KHFP26A100C	KHFP26A100C	KHFP26A100C
-	-	-	KHRP26A1250C	-	KHRP26A1250C	-	KHRP26A1250C	KHRP26A1250C	KHRP26A1250C	KHRP26A1250C
-	-	-	KDDN26A4	-	KDDN26A8	-	KDDN26A8	KDDN26A12	KDDN26A12	KDDN26A16
-	-	-	-	-	-	-	-	-	-	-
KHRQM22M75H	-	-	-	-	-	-	-	-	-	-
KHRQ22M75H	-	-	-	-	-	-	-	-	-	-

		Ceiling mounted cassette units					
		Round flow (800x800)	4-way (600x600)	2-way blow			
		FXFQ 20~125A	FXZQ 15~50A	FXCQ 20~40A	FXCQ 50~63A	FXCQ 80 ~125A	
Adapters and control	BRC1E52A/B Premium wired remote control with full-text interface and back-light	●	●	●	●	●	
	BRC1D52 Standard wired remote control with weekly timer	●*4	●*4	●*4	●*4	●*4	
	Infrared remote control including receiver	BRC7FA532F	BRC7F530W *9*10 (white panel) BRC7F530S *9*10 (grey panel) BRC7EB530 *9*10 (standard panel)	BRC7C52	BRC7C52	BRC7C52	
	BRC2E52A Simplified wired remote control for heat recovery system	-	-	-	-	-	
	BRC3E52A Simplified wired remote control for heat pump system	-	-	-	-	-	
	DCS302C51 Central remote control	●	●	●	●	●	
	DCS301B51 Unified ON/OFF control	●	●	●	●	●	
	DST301B51 Schedule timer	●	●	●	●	●	
	DCC601A51 Centralized controller with cloud connection	●	●	●	●	●	
	DCM601A51 Intelligent Touch Manager	●	●	●	●	●	
	External wired temperature sensor	KRCS01-4	KRCS01-4	KRCS01-4	KRCS01-4	KRCS01-4	
	K.RSS External wireless temperature sensor	●	●	●	●	●	
	Adaptor for wiring (interlock for fresh air intake fan)	-	-	-	-	-	
	Wiring adapter for external monitoring/control via dry contacts and setpoint control via 0-140Ω	KRP4A53 *2*7	KRP4A53 *2	KRP4A51	KRP4A51	KRP4A51	
	Wiring adapter for external central monitoring/control (controls 1 entire system)	-	KRP2A52	KRP2A51	KRP2A51	KRP2A51	
	Wiring adapter with 4 output signals (Compressor / Error, Fan, Aux. heater, Humidifier output)	EKRP1C11 *2*7	EKRP1B2	EKRP1B2	EKRP1B2	EKRP1B2	
	Wiring adapter with 2 output signals (Compressor / Error, Fan output)	KRP1B57 *2*7	KRP1B57	-	-	-	
	Adapter for multi-tenant applications (24VAC PCB power supply interface)	DTA114A61	DTA114A61	-	-	-	
	External control adapter for outdoor unit	-	-	DTA104A61	DTA104A61	DTA104A61	
	Installation box / Mounting plate for adapter PCBs (For units where there is no space in the switchbox)	KRP1H98 *7	KRP1A101	KRP1C96	KRP1C96	KRP1C96	
	Connector for forced-off contact	standard	-	standard	standard	standard	
	Connection to centralized control	standard	-	-	-	-	
	KJB212A Electrical box with earth terminal (2 blocks)	●	-	●	●	●	
	KJB311A Electrical box with earth terminal (3 blocks)	●	-	●	●	●	
	KJB411A Electrical box with earth terminal	-	-	-	-	-	
	BRP7A51 *2/11 Digital input adaptor	●	●	-	-	-	
	Others	Decoration panel (obligatory for cassette units, optional for others, rear panel for FXLQ)	BYCQ140DG (self clean) *5/*6 BYCQ140DGF *5/*6 BYCQ140DW (white) *3 BYCQ140D7W1 (standard)	BYFQ60CW (white panel) BYFQ60CS (grey panel) BYFQ60B3 (standard panel)	BYBCQ40H	BYBCQ63H	BYBCQ125H
		Kit for mounting of decoration panel direct onto unit	-	-	-	-	-
Panel spacer for reducing required installation height		-	KDBQ44B60 (standard panel)	-	-	-	
Sealing kit for 3-directional or 2-directional air discharge		KDBHQ55B140 *7	BDBHQ44C60 (white & grey panel)	-	-	-	
Fresh air intake kit		KDDQ55B140-1 + KDDQ55B140-2 *7*8	KDDQ44XA60	-	-	-	
Air discharge adapter for round duct		-	-	-	-	-	
Filter chamber for bottom suction		-	-	KDDFP53B50	KDDFP53B80	KDDFP53B160	
Replacement long life filter		KAFP551K160	KAFP441BA60	KAFP531B50	KAFP531B80	KAFP531B160	
Drain pump kit		standard	standard	standard	standard	standard	
Sensor kit		BRYQ140A	BRYQ60AW (white panel) BRYQ60AS (grey panel)	-	-	-	
KEK26-1A Noise filter (for electromagnetic use only)		-	-	●	●	●	

*2 Installation box is necessary for these adapters

*3 The BYCQ140D7W1W has white insulation

Be informed that formation of dirt on white insulation is visibly stronger and that it is consequently not advised to install the BYCQ140D7W1W decoration panel in environments exposed to concentrations of dirt*

*4 Not recommended because of the limitation of the functions

*5 To be able to control the BYCQ140D7W1 the controller BRC1E is needed

*6 The BYCQ140D7W1 is not compatible with Multi and Split Non-Inverter Outdoor units

*7 Option not available in combination with BYCQ140D7W1

*8 Both parts of the fresh air intake are needed for each unit

*9 Sensing function not available

*10 Independently controllable flaps function not available

*11 Only possible in combination with simplified remote control BRC2/3E

Corner (1-way blow)		Concealed ceiling units (duct units)						
		Small	Slim	Standard				
FXKQ 25~40	FXKQ 63	FXDQ 20~25 M9	FXDQ 15~63A	FXSQ 15~32	FXSQ 40~50	FXSQ 63~80	FXSQ 100~125	FXSQ 140
●	●	●	●	●	●	●	●	●
●*4	●*4	●*4	●*4	●*4	●*4	●*4	●*4	●*4
BRC4C61	BRC4C61	BRC4C62	BRC4C65	BRC4C65	BRC4C65	BRC4C65	BRC4C65	BRC4C65
-	-	●	●	●	●	●	●	●
-	-	●	●	●	●	●	●	●
●	●	●	●	●	●	●	●	●
●	●	●	●	●	●	●	●	●
●	●	●	●	●	●	●	●	●
●	●	●	●	●	●	●	●	●
●	●	●	●	●	●	●	●	●
KRCS01-1	KRCS01-1	KRCS01-1	KRCS01-4	KRCS01-4	KRCS01-4	KRCS01-4	KRCS01-4	KRCS01-4
●	●	●	●	●	●	●	●	●
-	-	-	-	-	-	-	-	-
KRP4A51	KRP4A51	KRP4A51	KRP4A54	KRP4A52*2	KRP4A52*2	KRP4A52*2	KRP4A52*2	KRP4A52*2
KRP2A51	KRP2A51	KRP2A51	KRP2A53	KRP2A51*2	KRP2A51*2	KRP2A51*2	KRP2A51*2	KRP2A51*2
KRP1B61	KRP1B61	EKRP1B2	KRP1B56	EKRP1B2*2	EKRP1B2*2	EKRP1B2*2	EKRP1B2*2	EKRP1B2*2
-	-	-	-	-	-	-	-	-
-	-	EKMTAC	DTA114A61	DTA114A61	DTA114A61	DTA114A61	DTA114A61	DTA114A61
DTA104A61	DTA104A61	DTA104A61	DTA104A53	DTA104A61	DTA104A61	DTA104A61	DTA104A61	DTA104A61
-	-	-	KRP1B101	KRP1BA101/ KRP1B100	KRP1BA101/ KRP1B100	KRP1BA101/ KRP1B100	KRP1BA101/ KRP1B100	KRP1BA101/ KRP1B100
Standard	Standard	Standard	-	Standard	Standard	Standard	Standard	Standard
Standard	Standard	Standard	-	Standard	Standard	Standard	Standard	Standard
-	-	-	●	●	●	●	●	●
-	-	-	●	●	●	●	●	●
-	-	-	-	●	●	●	●	●
-	-	-	-	●	●	●	●	●
BYK45F	BYK71F	-	-	-	-	-	-	-
-	-	-	-	-	-	-	-	-
-	-	-	-	-	-	-	-	-
-	-	-	-	-	-	-	-	-
-	-	-	-	-	-	-	-	-
-	-	-	-	KDAP25A36A	KDAP25A56A	KDAP25A71A	KDAP25A140A	-
-	-	-	-	-	-	-	-	-
-	-	-	-	-	-	-	-	-
Standard	Standard	KDAJ25K56	standard	Standard	Standard	Standard	Standard	Standard
-	-	-	-	-	-	-	-	-
-	-	-	●	-	-	-	-	-

		Concealed ceiling units (duct units)				
				Large		
		FXMQ 50~80	FXMQ 100~125	FXMQ 200~250	FXTQ50~63	FXTQ80~100
Adapters and control	BRC1E52A/B Premium wired remote control with full-text interface and back-light	•	•	•	•	•
	BRC1D52 Standard wired remote control with weekly timer	•*4	•*4	•*4	•*4	•*4
	Infrared remote control including receiver	BRC4C65	BRC4C65	BRC4C65	BRC4C65	BRC4C65
	BRC2E52A Simplified wired remote control for heat recovery system	•	•	•	•	•
	BRC3E52A Simplified wired remote control for heat pump system	•	•	•	•	•
	DCS302C51 Central remote control	•	•	•	•	•
	DCS301B51 Unified ON/OFF control	•	•	•	•	•
	DCS601C51 Schedule timer	•	•	•	•	•
	DCC601A51 Centralized controller with cloud connection	•	•	•	•	•
	DCM601A51 Intelligent Touch Controller	•	•	•	•	•
	External wired temperature sensor	KRCS01-4	KRCS01-4	KRCS01-1	KRCS01-4	KRCS01-1
	K.RSS External wireless temperature sensor	•	•	•	•	•
	Wiring adapter for external monitoring/control via dry contacts and setpoint control via 0-140Ω	KRP4A51	KRP4A51	KRP4A51	KRP4A52 *2	KRP4A51
	Wiring adapter for external central monitoring/control (controls 1 entire system)	KRP2A51	KRP2A51	KRP2A51	KRP2A51 *2	KRP2A51
	Wiring adapter with 4 output signals (Compressor / Error, Fan, Aux. heater, Humidifier output)	EKRP1B2	EKRP1B2	KRP1B61	EKRP1B2 *2	KRP1B61
	Wiring adapter with 2 output signals (Compressor / Error, Fan output)	-	-	-	-	-
	Adapter for multi-tenant applications (24VAC PCB power supply interface)	DTA114A61	DTA114A61	-	DTA114A61	-
	External control adapter for outdoor unit	DTA104A61	DTA104A61	DTA104A61	DTA104A61	DTA104A61
	Installation box / Mounting plate for adapter PCBs (For units where there is no space in the switchbox)	KRP4A96	KRP4A96	-	KRP1BA101 / KRP1B100	-
	Connector for forced-off contact	Standard	Standard	Standard	Standard	Standard
	Connection to centralized control	Standard	Standard	Standard	Standard	Standard
	KJB212A Electrical box with earth terminal (2 blocks)	-	-	-	•	-
	KJB311A Electrical box with earth terminal (3 blocks)	-	-	-	•	-
	KJB411A Electrical box with earth terminal	-	-	-	•	-
	BRP7A51 *2 / 11 Digital input adaptor	-	-	-	•	-
	Others	Decoration panel (obligatory for cassette units, optional for others, rear panel for FXLQ)	BYB571D	BYB5125D	-	-
Kit for mounting of decoration panel direct onto unit		EKBYBSD	EKBYBSD	-	-	-
Panel spacer for reducing required installation height		-	-	-	-	-
Sealing kit for 3-directional or 2-directional air discharge		-	-	-	-	-
Decoratoinpanel for air discharge		-	-	-	-	-
Fresh air intake kit		-	-	-	-	-
Air discharge adapter for round duct		KDAJ25K71	KDAJ25K140	-	KDAP25A140A	-
Replacement long life filter		-	-	-	-	-
Drain pump kit		Standard	Standard	-	Standard	-
Sensor kit		-	-	-	-	-
KEK26-1 Noise filter (for electromagnetic use only)		-	-	•	-	•
L-type piping kit (for upward direction)		-	-	-	-	-

*2Installation box is necessary for these adapters

*3The BYCQ140D7WIW has white insulation

Be informed that formation of dirt on white insulation is visibly stronger and that it is consequently not advised to install the BYCQ140D7WIW decoration panel in environments exposed to concentrations of dirt

*4Not recommended because of the limitation of the functions

*5To be able to control the BYCQ140D7GW1 the controller BRC1E is needed

*6The BYCQ140D7GW1 is not compatible with Mini VRV, Multi and Split Non-Inverter Outdoor units

*7Option not available in combination with BYCQ140D7GW1

*8Both parts of the fresh air intake are needed for each unit

*9Sensing function not available

*10 Independently controllable flaps function not available

*11 Only possible in combination with simplified remote control BRC2/3E

Ceiling suspended units				Wall mounted units	Floor standing units			
1-way blow			4-way blow		Concealed	Free-standing		
FXHQ 32A	FXHQ 63A	FXHQ 71~100A	FXUQ 71~100A	FXAQ 15~63	FXNQ 20~63	FXLQ 20~25	FXLQ 32~40	FXLQ 50~63
•	•	•	•	•	•	•	•	•
•*4	•*4	•*4	•*4	•*4	•*4	•*4	•*4	•*4
BRC7G53	BRC7G53	BRC7G53	BRC7C58	BRC7EB518	BRC4C65	BRC4C65	BRC4C65	BRC4C65
-	-	-	-	-	•	•	•	•
-	-	-	-	-	•	•	•	•
•	•	•	•	•	•	•	•	•
•	•	•	•	•	•	•	•	•
•	•	•	•	•	•	•	•	•
•	•	•	•	•	•	•	•	•
•	•	•	•	•	•	•	•	•
KRCS01-4	KRCS01-4	KRCS01-4	KRCS01-4	KRCS01-1	KRCS01-4	KRCS01-1	KRCS01-1	KRCS01-1
•	•	•	•	•	•	•	•	•
KRP4A52	KRP4A52	KRP4A52	KRP4A53 *2	KRP4A51	KRP4A54	KRP4A51	KRP4A51	KRP4A51
KRP2A62	KRP2A62	KRP2A62	-	KRP2A51	KRP2A53	KRP2A51	KRP2A51	KRP2A51
-	-	-	-	-	KRP1B56	KRP1B61	KRP1B61	KRP1B61
KRP1B54	KRP1B54	KRP1B54	-	-	-	-	-	-
-	-	-	-	DTA114A61	DTA114A61	EKMTAC	EKMTAC	EKMTAC
DTA104A62	DTA104A62	DTA104A62	-	DTA104A61	-	-	-	-
KRP1D93A	KRP1D93A	KRP1D93A	KRP1B97	KRP4A93	-	-	-	-
EKRORO4	EKRORO4	EKRORO4	EKRORO5	Standard	Standard	Standard	Standard	Standard
-	-	-	-	Standard	Standard	Standard	Standard	Standard
•	•	•	•	-	•	-	-	-
•	•	•	•	-	•	-	-	-
-	-	-	-	-	-	-	-	-
-	-	-	-	-	•	-	-	-
-	-	-	-	-	-	EKRDP25A	EKRDP40A	EKRDP63A
-	-	-	-	-	-	-	-	-
-	-	-	-	-	-	-	-	-
-	-	-	KDBHP49B140	-	-	-	-	-
-	-	-	KDBTP49B140	-	-	-	-	-
KDDQ50A140	KDDQ50A140	KDDQ50A140	-	-	-	-	-	-
-	-	-	-	-	-	-	-	-
KAFP501A56	KAFP501A80	KAFP501A160	KAFP551K160	-	-	-	-	-
KDU50P60	KDU50P140	KDU50P140	-	K-KDU572EVE	-	-	-	-
-	-	-	-	-	-	-	-	-
•	•	•	-	-	•	-	-	-
KHFP5M35	KHFP5N63	KHFP5N160	-	-	-	-	-	-
				HXY080-125A	HXHD125A			
Drain pan				EKHBDFCA2	-			
Digital I/O PCB				EKRPIHBAA	-			
Demand PCB - Required to connect room thermostat				EKRPIAHTA	-			
Remote user interface (remocon) - Same controller as supplied with cascade unit can be mounted parallel or on other location. If 2 controllers are installed, the installer needs to select 1 master & 1 slave				EKRUAHTB	-			
Back-up heater				EKBHAA6(W1/V3)	-			
Wired room thermostat - Requires demand PCB EKRPIAHTA				EKRRTWA	-			
Wireless room thermostat - Requires demand PCB EKRPIAHTA				EKRRTRI	-			
Remote sensor for room thermostat - Requires demand PCB EKRPIAHTA				EKRRTETS	-			
Domestic hot water tank - standard (stacked on top of hydrobox)				-	EKHTS200AC EKHTS260AC			
Domestic hot water tank - with possibility for solar connection				-	EKHWP500B			
Solar collector *1				-	EKSV26P (vertical) EKSH26P (horizontal)			
Pump station				-	EKSRPS			

*1 pump station is necessary for this option



Daikin offers the widest range in DX ventilation in the market.

With a variety of ventilation solutions from small heat recovery ventilation to large scale air handling units we help provide a fresh, healthy and comfortable environment in offices, hotels, stores and other commercial environments.

Ventilation & biddle air curtains

Ventilation	296	Biddle air curtains	
Heat reclaim ventilation	298	Biddle air curtain for ERQ	308
VAM-FA/FB	298	Biddle air curtain for VRV and Conveni-pack	309
VH - electrical heater	299		
VKM-GB(M)	300	Options & accessories	310
Air handling applications			
Overview & control possibilities	301		
VRV	304		
ERQ	305		
Expansion valves and control boxes	306		



VAM - HEAT RECLAIM VENTILATION



CYV BIDDLE AIR CURTAIN

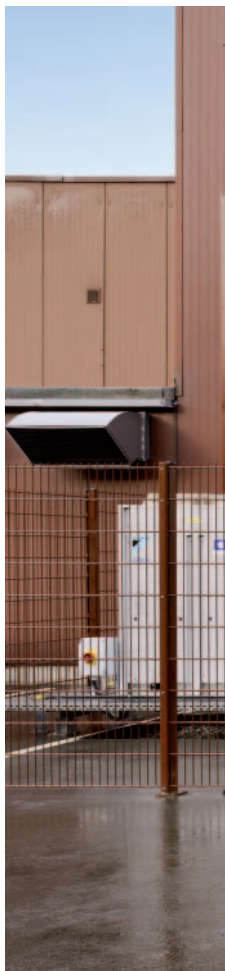



DAIKIN AIR HANDLING UNIT AND ERQ/VRV PLUG & PLAY CONNECTION



Heat reclaim ventilation

Ventilation with heat recovery as standard

- › Energy saving ventilation using indoor heating, cooling and moisture recovery
- › Ideal solution for shops, restaurants or offices requiring maximum floor space for furniture, decorations and fittings
- › Free cooling possible when outdoor temperature is below indoor temperature (eg. during nighttime)
- › Reduced energy consumption thanks to specially developed DC fan motor
- › Prevent energy losses from over-ventilation while maintaining indoor air quality with optional CO₂ sensor
- › Can be used as stand alone unit or integrated in the VRV system
- › Wide range of units: air flow rate from 150 up to 2,000 m³/h
- › High efficiency filters available in F6 ,F7, F8 grades
- › Shorter installation time thanks to easy adjustment of nominal air flow rate, so less need for dampers compared with traditional installation.
- › Specially developed heat exchange element with High Efficiency Paper (HEP)
- › No drain piping needed
- › Can operate in over- and under pressure
- › Total solution for fresh air with Daikin supply of both VAM and electrical heaters

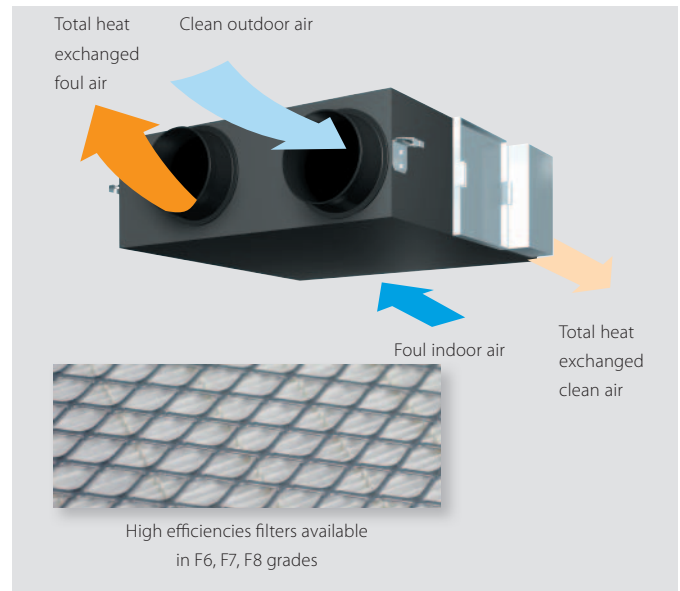

Ventilation		VAM	150FC	250FC	350FC	500FC	650FC	800FC	1000FC	1500FC	2000FC		
Power input - 50Hz	Nom. Ultra high	W/(m ³ /h)	132.4	161.2	56.2	146.9	187.8	320.1	360.1	616.7	684.5		
Temperature exchange efficiency - 50Hz (1)	Ultra high/High/Low	%	77.7 / 77.0 / 83.6	75.6 / 76.7 / 80.9	78.8 / 80.1 / 84.9	76.9 / 78.8 / 80.9	76.1 / 78.3 / 80.3	76.9 / 78.1 / 79.1	78.8 / 79.4 / 80.9	78.0 / 79.5 / 80.8	78.8 / 79.4 / 81.4		
Enthalpy exchange efficiency - 50Hz	Cooling Heating	Ultra high/High/Low Ultra high/High/Low	%	76.7 80.9	80.1 84.9	78.8 80.9	78.3 80.3	78.1 79.1	79.4 80.9	79.5 80.8	79.4 81.4		
Operation mode		Heat exchange mode / Bypass mode / Fresh-up mode											
Heat exchange system		Air to air cross flow total heat (sensible + latent heat) exchange											
Heat exchange element		Specially processed non-flammable paper											
Dimensions	Unit	HeightxWidthxDepth	mm	285x776x525			301x828x816		364x1,004x868		364x1,004x1,156	726x1,512x868	726x1,512x1,156
Weight	Unit		kg	24		33		52 55		64	131	152	
Casing		Material	Galvanised steel plate										
Fan-Air flow rate - 50Hz	Ultra high	m ³ /h	150	250	350	500	650	800	1000	1500	2000		
Fan-External static pressure - 50Hz	Ultra high	Pa	90.0	70.0	102.9	82.9	100.4	109.4	147.0	115.8	131.5		
	High	Pa	86.7	62.5	93.6	57.3	72.5	94.2	135.1	96.7	118.3		
	Low	Pa	40.3	25.0	51.5	35.0	48.8	78.3	99.6	80.4	76.6		
Air filter	Type	-											
Sound pressure level - 50Hz	Ultra high	dBA	27 / 28.5	28 / 29	32	33	34.5	36	39.5	40			
	Ultra high	dBA	27 / 28.5	28 / 29	32	33.5	34.5	36	40.5	40			
Operation range	Min.	°CDB	-15										
	Max.	°CDB	50										
	Relative humidity	%	80% or less										
Refrigerant	Type / GWP	-											
Connection duct diameter	mm	100	150	200	250	350							
Power supply	Phase/Frequency/Voltage	Hz/V	1~/50/60/220-240/220										
Current	Maximum fuse amps (MFA)	A	-										
Energy efficiency class			-										
SEC class			-										
Maximum flow rate at 100 Pa ESP	Flow rate	m ³ /h	-										
Sound power		B	-										
Annual electricity consumption		kWh/a	-										
Annual heating saved		kWh/a	-										

*Note: blue cells contain preliminary data

(1) Measured according to JIS B 8628

VH

- › Total solution for fresh air with Daikin supply of both VAM and electrical heaters
- › Increased comfort in low outdoor temperature thanks to the heated outdoor air
- › Integrated electrical heater concept (no additional accessories required)
- › Standard dual flow and temperature sensor
- › Flexible setting with adjustable setpoint
- › Increased safety with 2 cut-outs: manual & automatic
- › BMS integration thanks to:
 - Volt free relay for error indication
 - 0-10VDC input for setpoint control

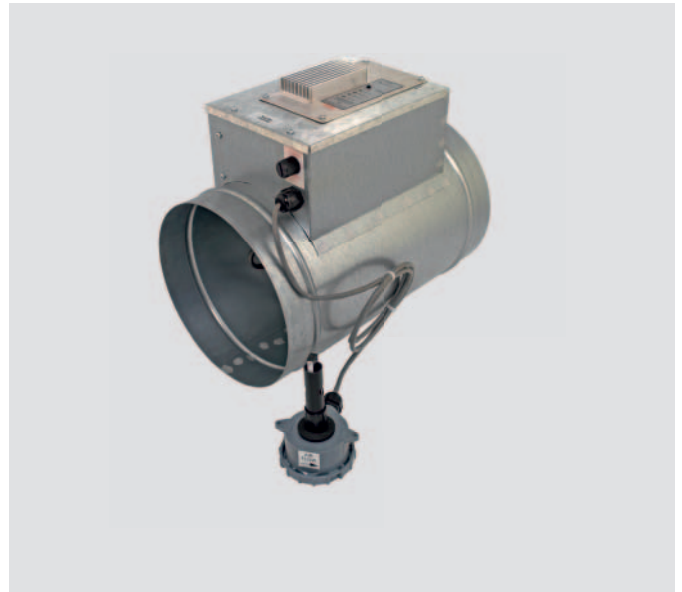

ELECTRICAL HEATER FOR VAM	VH	(VH)
Supply voltage		220/250V ac 50/60 Hz. +/-10%
Output current (maximum)		19A at 40°C (ambient)
Temperature sensor		5k ohms at 25°C (table 502 1T)
Temperature control range		0 to 40°C / (0-10V 0-100%)
Control fuse		20 x 5mm 250mA
LED indicators		Power ON - Yellow Heater ON - Red (solid or flashing, indicating pulsed control) Airflow fault - Red
Mounting holes		98mm x 181mm centres 5 mm ø holes
Maximum ambient adjacent to terminal box		35°C (during operation)
Auto high temp. cutout		100°C Pre-set
Man. reset high temp. cutout		125°C Pre-set
Run relay		1A 120V AC or 1A 24V DC
BMS setpoint input		0-10VDC

		VH	1B	2B	3B	4B	4/AB	5B
Capacity	kW		1	1	1	1.5	2.5	2.5
Duct diameter	mm		100	150	200	250	250	300
Connectable VAM			VAM150FC -	VAM250FC VAM350FC	VAM500FC VAM650FC	VAM800FC VAM1000FC	VAM800FC VAM1000FC	VAM1500FC VAM2000FC

For the selection of the appropriate capacity, please refer to the VAM selection software.

Heat reclaim ventilation and air processing

Pre heating or cooling of fresh air for lower load on the air conditioning system

- › Energy saving ventilation using indoor heating, cooling and moisture recovery
- › Creates a high quality indoor environment by pre conditioning incoming fresh air
- › Humidification of the incoming air results in comfortable indoor humidity level, even during heating
- › Ideal solution for shops, restaurants or offices requiring maximum floor space for furniture, decorations and fittings
- › Free cooling possible when outdoor temperature is below indoor temperature (eg. during nighttime)
- › Low energy consumption thanks to DC fan motor
- › Prevent energy losses from over-ventilation while maintaining indoor air quality with optional CO₂ sensor



- › Shorter installation time thanks to easy adjustment of nominal air flow rate, so less need for dampers compared with traditional installation.
- › Specially developed heat exchange element with High Efficiency Paper (HEP)
- › Can operate in over- and under pressure

Operation example: humidification & air processing (heating mode)¹

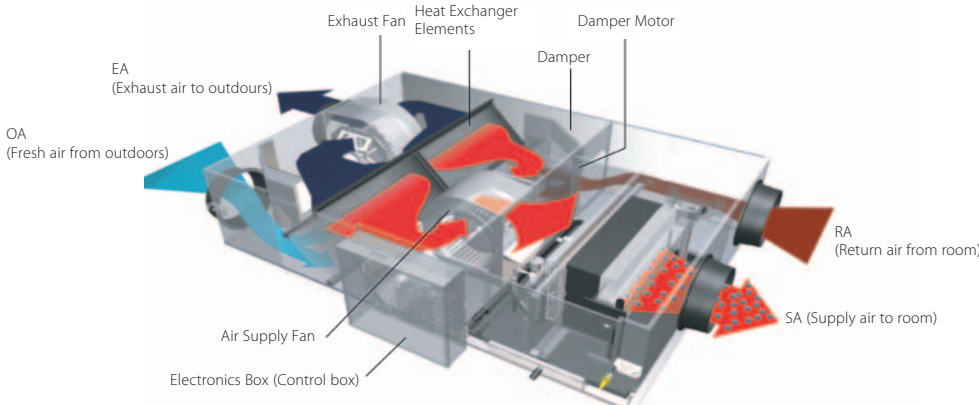

Ventilation				Heat reclaim ventilation and air processing			Heat reclaim ventilation, air processing and humidification			
VKM-GB/VKM-GBM				50GB	80GB	100GB	50GBM	80GBM	100GBM	
Power input - 50Hz	Heat exchange mode	Nom.	Ultra high	kW	0.270	0.330	0.410	0.270	0.330	0.410
	Bypass mode	Nom.	Ultra high	kW	0.270	0.330	0.410	0.270	0.330	0.410
Fresh air conditioning load	Cooling			kW	4.71 / 1.91 / 3.5	7.46 / 2.96 / 5.6	9.12 / 3.52 / 7.0	4.71 / 1.91 / 3.5	7.46 / 2.96 / 5.6	9.12 / 3.52 / 7.0
	Heating			kW	5.58 / 2.38 / 3.5	8.79 / 3.79 / 5.6	10.69 / 4.39 / 7.0	5.58 / 2.38 / 3.5	8.79 / 3.79 / 5.6	10.69 / 4.39 / 7.0
Temperature exchange efficiency - 50Hz	Ultra high/High/Low			%	76/76/77.5	78/78/79	74/74/76.5	76/76/77.5	78/78/79	74/74/76.5
Enthalpy exchange efficiency - 50Hz	Cooling	Ultra high/High/Low		%	64/64/67	66/66/68	62/62/66	64/64/67	66/66/68	62/62/66
	Heating	Ultra high/High/Low		%	67/67/69	71/71/73	65/65/69	67/67/69	71/71/73	65/65/69
Operation mode				Heat exchange mode / Bypass mode / Fresh-up mode						
Heat exchange system				Air to air cross flow total heat (sensible + latent heat) exchange						
Heat exchange element				Specially processed non-flammable paper						
Humidifier		System		-			Natural evaporating type			
Dimensions	Unit	HeightxWidthxDepth		mm	387x1,764x832	387x1,764x1,214		387x1,764x832	387x1,764x1,214	
Weight	Unit			kg	94	110	112	100	119	123
Casing	Material		Galvanised steel plate							
Fan-Air flow rate - 50Hz	Heat exchange mode	Ultra high		m ³ /h	500	750	950	500	750	950
	Bypass mode	Ultra high		m ³ /h	500	750	950	500	750	950
Fan-External static pressure - 50Hz	Ultra high			Pa	210		150	200	205	110
	High			Pa	170	160	100	150	155	70
	Low			Pa	140	110	70	120	105	60
Air filter				Type	Multidirectional fibrous fleeces					
Sound pressure level - 50Hz	Heat exchange mode	Ultra high		dB(A)	39	41.5	41	38	40	
	Bypass mode	Ultra high		dB(A)	40	41.5	41	39	41	
Operation range	Around unit			°CDB	0°C~40°CDB, 80% RH or less					
	Supply air			°CDB	-15°C~40°CDB, 80% RH or less					
	Return air			°CDB	0°C~40°CDB, 80% RH or less					
	On coil temperature	Cooling	Max.	°CDB	43			-15	43	
Refrigerant	Type			R-410A						
	Control			Electronic expansion valve						
	GWP			2,087.5						
Connection duct diameter				mm	200	250	200	250		
Piping connections	Liquid	OD		mm	6.35					
	Gas	OD		mm	12.7					
	Water supply			mm	-					
	Drain			PT3/4 external thread						
Power supply	Phase/Frequency/Voltage			Hz/V	1~/50/220-240					
Current	Maximum fuse amps (MFA)			A	15					

Air handling unit applications

Wide range of air flows

For applications that require big volumes of treated fresh air (large atriums, banquet halls, etc) air handling units represent the ideal solution. Daikin's wide range of air handling units treat air volumes from 500 m³/h up to 140,000 m³/h.

The air handling unit can be designed to deliver whatever air flow you require, via the specific dimensions of flow section available at the installation.

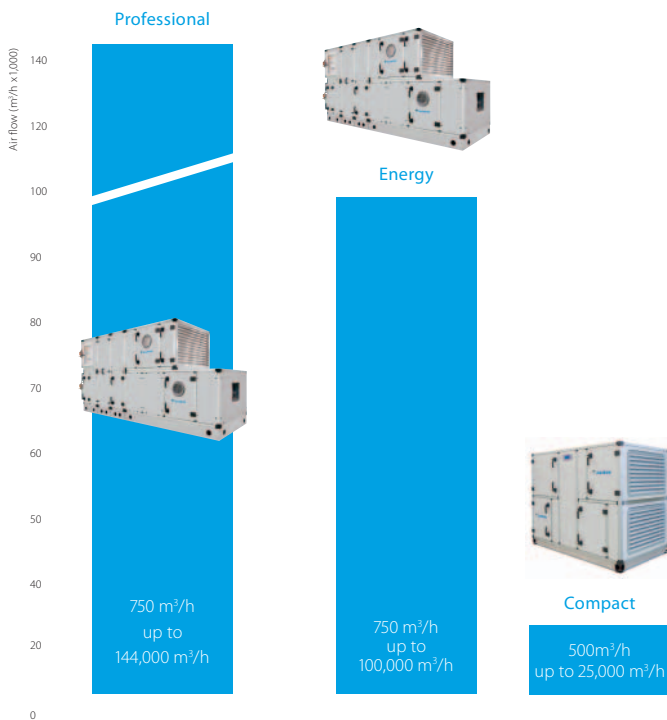

Professional

- › Pre-configured sizes
- › Tailored to the individual customer
- › Modular construction

Energy

- › High-end solution for optimised energy consumption
- › High efficiency components
- › Strong Return on Investment

Compact

- › Plug & play, with factory mounted controls
- › Pre-configured sizes
- › EC Fan Technology
- › High Efficiency Heat Wheel
- › Compact Design

Selection software

ASTRA is the powerful software that Daikin has developed to offer a quick and comprehensive service for the customer in order to make the technical choice and the economic valorization of each AHU. It is a complete tool that can configure any type of product and respond exactly to the strictest design needs. The result is a comprehensive economic offer including all the technical data and drawings, the psychrometric diagram with the relative air treatment and the fans' performance curves. The ASTRA software features a specific DX heat pump coil section able to calculate cooling and heating performances with the automatic selection of the appropriate Daikin expansion valve. The complementary Xpress software allows

the correct ERQ or VRV outdoor unit to be selected.

Daikin fresh air package - plug & play

The D-AHU Modular series provide a complete solution including unit control (EKEXV, EKEQ, DDC controller) factory mounted and configured, plug & play with our VRV and ERQ condensing units. The easiest solution as you save time and only have one point of contact!

Return on investment

The air handling unit (AHU) is critical to an effective climate control system and the savings generated by our advanced designs and operating efficiencies guarantee a rapid return on the investment made. Our AHU Energy series has been designed to deliver exceptional performance thus driving down the energy consumed and so lowering energy bills. Taken over the expected 15-year life-span of the equipment, this will result in a substantial saving, especially in a time of ever increasing energy prices.

Pre-defined sizes

27 fixed sizes are available, optimised to reach the optimum combination between value for money and manufacturing standardisation. Daikin's section by section design means that units can be sized by 1cm increments and assembled on site, without welding, to suit the space constraints of the installation.

High efficiency components

All Daikin air handling units have been designed for optimum energy efficiency. Polyurethane or Mineral wool panels guarantee excellent thermal insulation performance. And the widest range of filters are provided to meet even the most strict demands.

Why use VRV and ERQ condensing units for connection to air handling units?

High Efficiency

Daikin heat pumps are renowned for their high energy efficiency. Integrating the AHU with a heat recovery system is even more effective since an office system can frequently be in cooling mode

while the outdoor air is too cold to be brought inside in an unconditioned state. In this case heat from the offices is merely transferred to heat up the cold incoming fresh air.

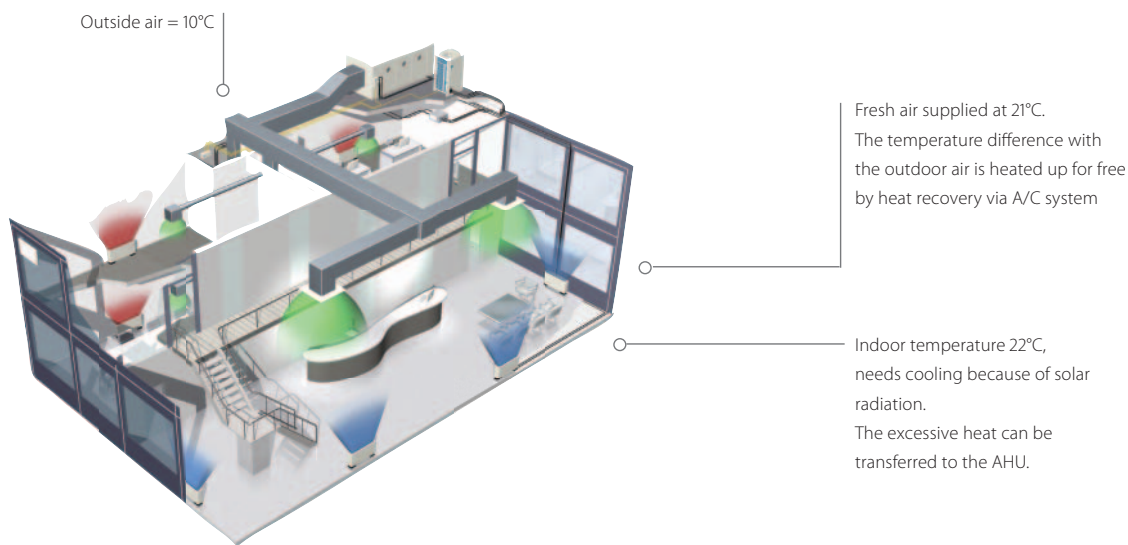

Fast response to changing loads resulting in high comfort levels

Daikin ERQ and VRV units respond rapidly to fluctuations in supply air temperature, resulting in a steady indoor temperature and resultant high comfort levels for the end user. The ultimate is the VRV range which improves comfort even more by offering continuous heating, also during defrost.

Easy Design and Installation

The system is easy to design and install since no additional water systems such as boilers, tanks and gas connections etc. are required. This also reduces both the total system investment and running cost.

Daikin Fresh air package

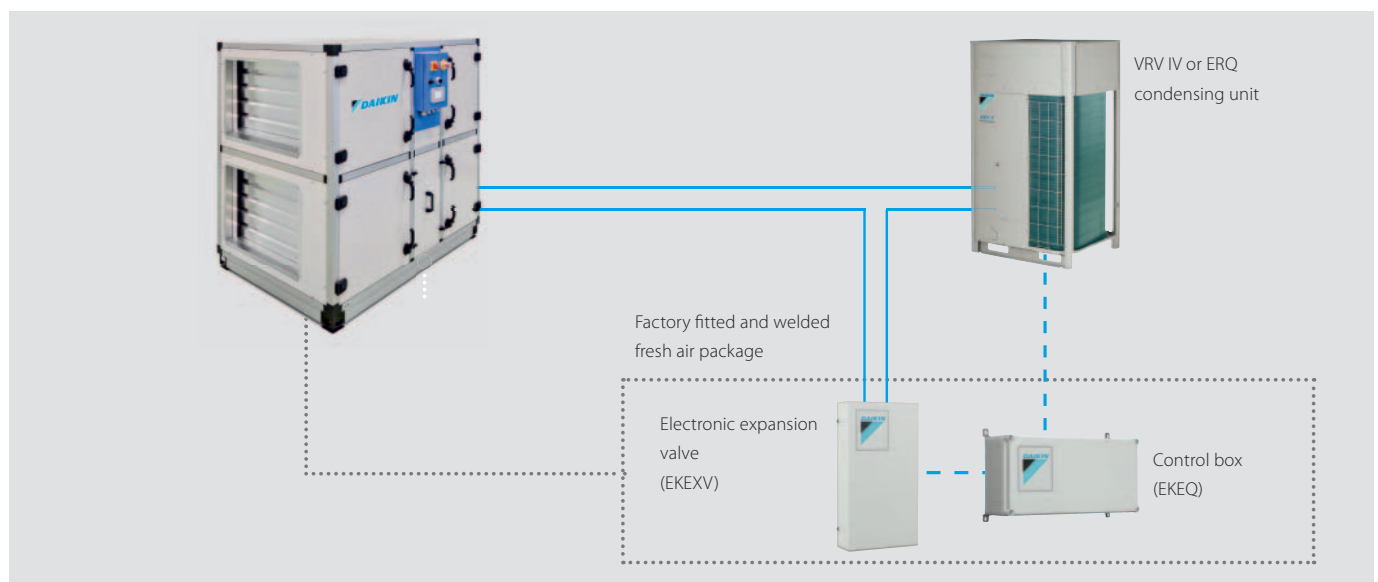

In order to maximise installation flexibility, 4 types of control systems are offered

W control: Off the shelf control of air temperature (discharge temperature, suction temperature, room temperature) via any DDC controller, easy to setup

X control: Precise control of air temperature (discharge temperature, suction temperature, room temperature) requiring a preprogrammed DDC controller (for special applications)

Z control: Control of air temperature (suction temperature, room temperature) via Daikin control (no DDC controller needed)

Y control: Control of refrigerant (Te/Tc) temperature via Daikin control (no DDC controller needed)

1. W control ($T_S/T_R/T_{ROOM}$ control):

Air temperature control via DDC controller

Room temperature is controlled as a function of the air handling unit suction or discharge air (customer selection). The DDC controller is translating the temperature difference between set point and air suction temperature (or air discharge temperature or room temperature) into a proportional 0-10V signal which is transferred to the Daikin control box (EKEQFCBA). This voltage modulates the capacity requirements of the outdoor unit.

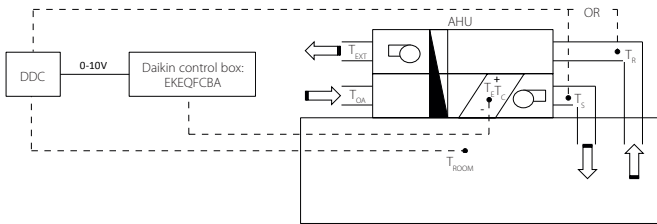

2. X control ($T_S/T_R/T_{ROOM}$ control):

Precise air temperature control via DDC controller

Room temperature is controlled as a function of the air handling unit suction or discharge air (customer selection). The DDC controller is translating the temperature difference between set point and air suction temperature (or air discharge temperature or room temperature) into a reference voltage (0-10V) which is transferred to the Daikin control box (EKEQFCBA). This reference voltage will be used as the main input value for the compressor frequency control.

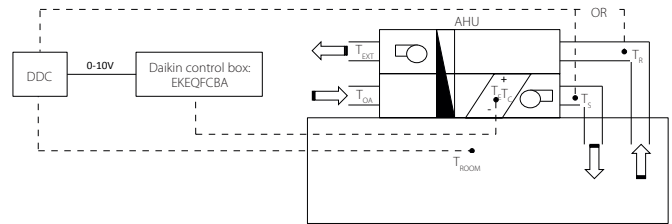

3. Y control (T_E/T_C control):

By fixed evaporating /condensing temperature

A fixed target evaporating or condensing temperature can be set by the customer. In this case, room temperature is only indirectly controlled. A Daikin infrared remote control (BRC1D52 or BRC1E52A/B - optional) have to be connected for initial set-up but not required for operation.

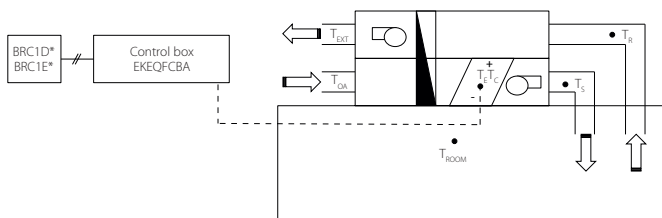

4. Z control (T_S/T_{ROOM} control):

Control your AHU just like a VRV indoor unit with 100% fresh air

Allows the possibility to control the AHU just like a VRV indoor unit. Meaning temperature control will be focused on return air temperature from the room into the AHU. Requires BRC1D52 or BRC1E52A/B for operation. The only control that allows the combination of other indoor units to the AHU at the same time.

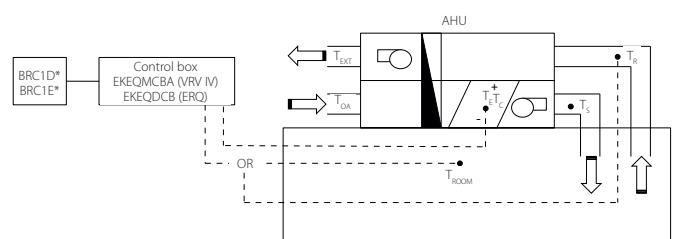

T_S = Supply air temperature	T_R = Return air temperature	T_{DA} = Outdoor air temperature	T_{ROOM} = Room air temperature
T_{EXT} = Extraction air temperature	T_E = Evaporating temperature	T_C = Condensing temperature	

	Option kit	Features
Possibility w	EKEQFCBA	Off-the-shelf DDC controller that requires no pre-configuration
Possibility x		Pre-configured DDC controller required
Possibility y		Using fixed evaporating temperature, no set point can be set using remote control
Possibility z	EKEQDCB EKFQMCBA*	Using Daikin infrared remote control BRC1D52 or BRC1E52A/B Temperature control using air suction temperature

* EKEQMCB (for 'multi' application)

VRV - for larger capacities (from 8 to 54HP)

An advanced solution for both pair and multi application

- › Inverter controlled units
- › Heat recovery, heat pump
- › R-410A
- › Control of room temperature via Daikin control
- › Large range of expansion valve kits available
- › BRC1E52A/B is used to set the set point temperature (connected to the EKEQMCBA).
- › Connectable to all VRV heat recovery and heat pump systems

W, X, Y control for VRV IV heat pump

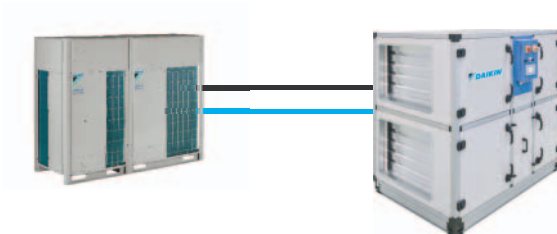

Z control for all VRV outdoor units

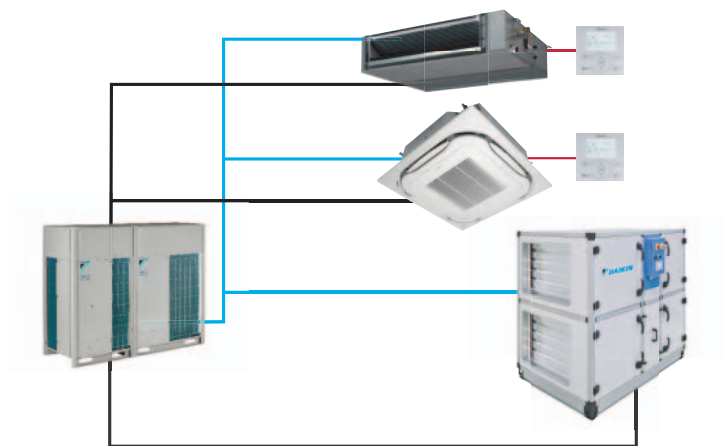

- Refrigerant piping
- F1-F2
- other communication



ERQ - for smaller capacities (from 100 to 250 class)

An basic fresh air solution for pair application

- › Inverter controlled units
- › Heat pump
- › R-410A
- › Wide range of expansion valve kits available
- › Perfect for the Daikin Modular air handling unit

The "Daikin Fresh Air Package" provides a complete Plug & Play Solution including AHU, ERQ or VRV Condensing Unit and all unit control (EKEQ, EKEX, DDC controller) factory mounted and configured. The easiest solution with only one point of contact.



ERQ-AW1

Ventilation				ERQ	100AV1	125AV1	140AV1
Capacity range				HP	4	5	6
Cooling capacity Nom.				kW	11.2	14.0	15.5
Heating capacity Nom.				kW	12.5	16.0	18.0
Power input	Cooling	Nom.	kW	2.81	3.51	4.53	
	Heating	Nom.	kW	2.74	3.86	4.57	
EER					3.99		3.42
COP					4.56	4.15	3.94
Dimensions	Unit	mm		1,345x900x320			
Weight	Unit	kg		120			
Fan-Air flow rate	Cooling	Nom.	m ³ /min	106			
	Heating	Nom.	m ³ /min	102	105		
Sound power level	Cooling	Nom.	dBa	66	67	69	
Sound pressure level	Cooling	Nom.	dBa	50	51	53	
	Heating	Nom.	dBa	52	53	55	
Operation range	Cooling	Min./Max.	°CDB	-5/46			
	Heating	Min./Max.	°CWB	-20/15.5			
	On coil temperature	Heating Min. / Cooling Max.	°CDB	10 / 35			
Refrigerant	Type / GWP			R-410A / 2.087,5			
	Charge			kg/ TCO ₂ Eq			
Piping connections	Liquid	OD	mm	4.0/8.4			
	Gas	OD	mm	15.9	9.52	19.1	
	Drain	OD	mm	26x3			
Power supply	Phase/Frequency/Voltage			1N~/50/220-240			
Current	Maximum fuse amps (MFA)			A			
					32.0		

Ventilation				ERQ	125AW1	200AW1	250AW1
Capacity range				HP	5	8	10
Cooling capacity Nom.				kW	14.0	22.4	28.0
Heating capacity Nom.				kW	16.0	25.0	31.5
Power input	Cooling	Nom.	kW	3.52	5.22	7.42	
	Heating	Nom.	kW	4.00	5.56	7.70	
EER					3.98	4.29	3.77
COP					4.00	4.50	4.09
Dimensions	Unit	mm		1,680x635x765	1,680x930x765		
Weight	Unit	kg		159	187	240	
Fan-Air flow rate	Cooling	Nom.	m ³ /min	95	171	185	
	Heating	Nom.	m ³ /min	95	171	185	
Sound power level	Nom.			dBa	72	78	
Sound pressure level	Nom.			dBa	54	57	58
Operation range	Cooling	Min./Max.	°CDB	-5/43			
	Heating	Min./Max.	°CWB	-20/15			
	On coil temperature	Heating Min. / Cooling Max.	°CDB	10 / 35			
Refrigerant	Type / GWP			R-410A / 2.087,5			
	Charge			kg/ TCO ₂ Eq			
Piping connections	Liquid	OD	mm	6.2/12.9	7.7/16.1	8.4/17.5	
	Gas	OD	mm	15.9	19.1	22.2	
	Phase/Frequency/Voltage			Hz/V			
Power supply				3N~/50/400			
Current	Maximum fuse amps (MFA)			A	16	25	

Integration of ERQ and VRV in third party air handling units

a wide range of expansion valve kits and control boxes

Combination table

		Control box			Expansion valve kit										Mixed connection with VRV indoor units		
		EKEQDCB	EKEQFCBA	EKEQMCBA	EKE XV50	EKE XV63	EKE XV80	EKE XV100	EKE XV125	EKE XV140	EKE XV200	EKE XV250	EKE XV400	EKE XV500			
		Z control	W,X,Y control	Z control	-	-	-	-	-	-	-	-	-	-	-	-	-
1-phase	ERQ100	P	P	-	-	P	P	P	P	-	-	-	-	-	-	-	-
	ERQ125	P	P	-	-	P	P	P	P	P	-	-	-	-	-	-	-
	ERQ140	P	P	-	-	-	P	P	P	P	-	-	-	-	-	-	-
3-phase	ERQ125	P	P	-	-	P	P	P	P	P	-	-	-	-	-	-	-
	ERQ200	P	P	-	-	-	-	P	P	P	P	P	-	-	-	-	-
	ERQ250	P	P	-	-	-	-	-	P	P	P	P	-	-	-	-	-
VRV III		-	-	n1	n1	n1	n1	n1	n1	n1	n1	n1	n1	n1	n1	n1	Mandatory
VRV IV H/P / VRV IV W-series VRV IV S-series		-	P (1 -> 3)	n2	n2	n2	n2	n2	n2	n2	n2	n2	n2	n2	n2	n2	Possible (not mandatory)
VRV IV H/R VRV IV i-series		-	n1	-	n1	n1	n1	n1	n1	n1	n1	n1	n1	n1	n1	n1	Mandatory

- P (pair application): combination depends on the capacity of the air handling unit
- n1 (multi application) - Combination of AHUs and VRV DX indoors (mandatory). To determine the exact quantity please refer to the engineering data book.
- n2 (multi application) - Combination of AHUs and VRV DX indoors (not mandatory). To determine the exact quantity please refer to the engineering data book.
- Control box EKEQFA can be connected to some types of VRV IV outdoor units (with a maximum of 3 boxes per unit). Do not combine EKEQFA control boxes with VRV DX indoor units, RA indoor units or hydroboxes

Capacity table

Cooling

EKE XV Class	Allowed heat exchanger capacity (kW)		
	Minimum	Standard	Maximum
50	5.0	5.6	6.2
63	6.3	7.1	7.8
80	7.9	9.0	9.9
100	10.0	11.2	12.3
125	12.4	14.0	15.4
140	15.5	16.0	17.6
200	17.7	22.4	24.6
250	24.7	28.0	30.8
400	35.4	45.0	49.5
500	49.6	56.0	61.6

Saturated evaporating temperature: 6°C
Air temperature: 27°C DB / 19°C WB

Heating

EKE XV Class	Allowed heat exchanger capacity (kW)		
	Minimum	Standard	Maximum
50	5.6	6.3	7.0
63	7.1	8.0	8.8
80	8.9	10.0	11.1
100	11.2	12.5	13.8
125	13.9	16.0	17.3
140	17.4	18.0	19.8
200	19.9	25.0	27.7
250	27.8	31.5	34.7
400	39.8	50.0	55.0
500	55.1	63.0	69.3

Saturated condensing temperature: 46°C
Air temperature: 20°C DB

EKE XV - Expansion valve kit for air handling applications

Ventilation		EKE XV	50	63	80	100	125	140	200	250	400	500
Dimensions	Unit	mm	401x215x78									
Weight	Unit	kg	2.9									
Sound pressure level	Nom.	dBA	45									
Operation range	On coil temperature	Heating Min. °CDB	10 (1)									
		Cooling Max. °CDB	35 (2)									
Refrigerant	Type / GWP		R-410A / 2.087,5									
Piping connections	Liquid OD	mm	6.35				9.52				12.7	15.9

(1) The temperature of the air entering the coil in heating mode can be reduced to -5°CDB. Contact your local dealer for more information. (2) 45% Relative humidity.

EKEQ - Control box for air handling applications

Ventilation		EKEQ	FCBA	DCB	MCBA
Application			See note	Pair	Multi
Outdoor unit			ERQ / VRV	ERQ	VRV
Dimensions	Unit	mm	132x400x200		
Weight	Unit	kg	3.9	3.6	
Power supply	Phase/Frequency/Voltage	Hz/V	1~/50/230		

The combination of EKEQFCBA and ERQ is in pair application. The EKEQFCBA can be connected to some type of VRV IV outdoor units with a maximum of 3 control boxes. The combination with DX indoor units, hydroboxes, RA outdoor units, ... is not allowed. Refer to the combination table drawing of the outdoor unit for details.

Pair application selection

- › **the outdoor unit is connected to ONE COIL (with single circuit or maximum 3 interlaced circuits) using up to 3 control boxes**
- › **indoor unit combination is not allowed**
- › **only works with X, W, Y control**

Step 1: Required AHU capacity

An AHU with double flow, heat recovery and 100% fresh air is to be installed in Europe where the outdoor sizing temperature is 35 °CDB and the target supply air temperature for fresh air is 25 °CDB. Load calculations point to a required capacity of 45kW. By checking on the EKEXV capacity table, for cooling operation, 40kW falls within the 400 class valve. Since 40kW is not the nominal capacity, a class adjustment has to be done. $40/45=0,89$ and $0,89 \times 400=356$. So the capacity class of the expansion valve kit is 356.

Step 2: Outdoor unit selection

For this AHU, a VRV IV heat pump model with continuous heating is going to be used (RYYQ-T series). For a capacity of 40kW at 35 °CDB, an outdoor of 14HP (RYYQ14T). The capacity class of the 14 HP outdoor unit is 350. Total connection ratio of the system is $356/350=102\%$ hence it falls within the range 90-110%.

Step 3: Control box selection

In this particular case, the control will work with precise air temperature control. Only W or X control allow this. Since the consultant wants to use an "off-the-shelf" DDC module, the EKEQFCBA box with W control allows easy set-up due to pre-set factory values.

Multi application selection

- › **the outdoor unit can be connected to MULTIPLE COILS (and their control boxes)**
- › **indoor units are also connectable but not mandatory**
- › **only work with Z control**

Step 1: Required AHU capacity

An AHU with double flow, heat recovery and 100% fresh air is to be installed in Europe where the outdoor sizing temperature is 35 °CDB and the target supply air temperature for fresh air is 25 °CDB. On top of this, for this building, 5 round-flow cassette units FXFQ50A will also be connected to this OU. Load calculations point to a required capacity of 20kW for the AHU and 22,5 kW for the indoor units. By checking on the EKEXV capacity table, for cooling operation, 20kW falls within the 200 class valve. Since 22,4 kW is the nominal capacity, a class adjustment has to be done. $20/22,4=0,89$ and $0,89 \times 200=178$. So the capacity class of the expansion valve kit is 178. Total capacity class of the indoor unit system is $178+250=428$

Step 2: Outdoor unit selection

For this system where a AHU is connected with indoor units, it is mandatory to use a heat recovery unit. By consulting the engineering databook for REYQ-T, the total required capacity of 42,5 kW requires a 16HP model REYQ16T. Which will deliver 45kW at the design temperature of 35 °CDB. This unit has a capacity class of 400. Total connection ratio of the system is $428/400=107\%$ hence it falls within the range 50-110%.

Step 3: Control box selection

In this particular case, the only available control is Z control and the combination of AHU and VRV DX indoor units requires EKEQMCBA control box.

Biddle air curtain for ERQ

- › Connectable to ERQ heat pump
- › ERQ is among the first DX systems suitable for connection to air curtains
- › Free-hanging model (F): easy wall mounted installation
- › Cassette model (C): mounted into a false ceiling leaving only the decoration panel visible
- › Recessed model (R): neatly concealed in the ceiling
- › A payback period of less than 1.5 years compared to installing an electric air curtain
- › Easy and quick to install at reduced costs since no additional water systems, boilers and gas connections are required
- › Maximum energy efficiency stemming from almost zero down flow turbulence, optimised air flow and the application of advanced discharge rectifier technology
- › Around 85% air separation efficiency, greatly reducing both heat loss and required indoor unit heating capacity

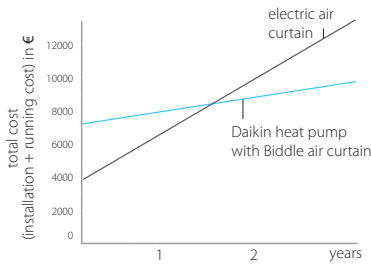

				Small			Medium			
				CYQS150DK80	CYQS200DK100	CYQS250DK140	CYQM100DK80	CYQM150DK80	CYQM200DK100	CYQM250DK140
				*BN/*SN	*BN/*SN	*BN/*SN	*BN/*SN	*BN/*SN	*BN/*SN	*BN/*SN
Heating capacity	Speed 3		kW	9.0	11.6	16.2	9.2	11.0	13.4	19.9
Power input	Fan only	Nom.	kW	0.35	0.46	0.58	0.37	0.56	0.75	0.94
	Heating	Nom.	kW	0.35	0.46	0.58	0.37	0.56	0.75	0.94
Delta T	Speed 3		K	15			16	17	14	15
Casing	Colour	BN: RAL9010 / SN: RAL9006								
Dimensions	Unit	Height F/C/R	mm	270/270/270						
		Width F/C/R	mm	1,500/1,500/1,548	2,000/2,000/2,048	2,500/2,500/2,548	1,000/1,000/1,048	1,500/1,500/1,548	2,000/2,000/2,048	2,500/2,500/2,548
		Depth F/C/R	mm	590/821/561						
Required ceiling void >			mm	420						
Door height	Max.		m	2.3 (1) / 2.15 (2) / 2.0 (3)	2.3 (1) / 2.15 (2) / 2.0 (3)	2.3 (1) / 2.15 (2) / 2.0 (3)	2.5 (1) / 2.4 (2) / 2.3 (3)	2.5 (1) / 2.4 (2) / 2.3 (3)	2.5 (1) / 2.4 (2) / 2.3 (3)	2.5 (1) / 2.4 (2) / 2.3 (3)
Door width	Max.		m	1.5	2.0	2.5	1.0	1.5	2.0	2.5
Weight	Unit		kg	66	83	107	57	73	94	108
Fan-Air flow rate	Heating	Speed 3	m ³ /h	1,746	2,328	2,910	1,605	2,408	3,210	4,013
Sound pressure level	Heating	Speed 3	dB(A)	49	50	51	50	51	53	54
Refrigerant	Type / GWP	R-410A / 2,087.5								
Piping connections	Liquid/OD/Gas/OD		mm	9.52/16.0		9.52/19.0	9.52/16.0		9.52/19.0	
Required accessories (should be ordered separately)	Daikin wired remote control (BRC1E52A/B or BRC1D52)									
Power supply	Voltage		V	230						

				Large				
				CYQL100DK125	CYQL150DK200	CYQL200DK250	CYQL250DK250	
				*BN/*SN	*BN/*SN	*BN/*SN	*BN/*SN	
Heating capacity	Speed 3		kW	15.6	23.3	29.4	31.1	
Power input	Fan only	Nom.	kW	0.75	1.13	1.50	1.88	
	Heating	Nom.	kW	0.75	1.13	1.50	1.88	
Delta T	Speed 3		K	15			12	
Casing	Colour	BN: RAL9010 / SN: RAL9006						
Dimensions	Unit	Height F/C/R	mm	370/370/370				
		Width F/C/R	mm	1,000/1,000/1,048	1,500/1,500/1,548	2,000/2,000/2,048	2,500/2,500/2,548	
		Depth F/C/R	mm	774/1,105/745				
Required ceiling void >			mm	520				
Door height	Max.		m	3.0 (1) / 2.75 (2) / 2.5 (3)	3.0 (1) / 2.75 (2) / 2.5 (3)	3.0 (1) / 2.75 (2) / 2.5 (3)	3.0 (1) / 2.75 (2) / 2.5 (3)	
Door width	Max.		m	1.0	1.5	2.0	2.5	
Weight	Unit		kg	76	100	126	157	
Fan-Air flow rate	Heating	Speed 3	m ³ /h	3,100	4,650	6,200	7,750	
Sound pressure level	Heating	Speed 3	dB(A)	53	54	56	57	
Refrigerant	Type / GWP	R-410A / 2,087.5						
Piping connections	Liquid/OD/Gas/OD		mm	9.52/16.0		9.52/19.0	9.52/22.0	
Required accessories (should be ordered separately)	Daikin wired remote control (BRC1E52A/B or BRC1D52)							
Power supply	Voltage		V	230				

(1) Favorable conditions: covered shopping mall or revolving door entrance (2) Normal conditions: little direct wind, no opposite open doors, building with ground floor only (3) Unfavorable conditions: location at a corner or square, multiple floors and/or open stairway

Biddle air curtain for VRV and Conveni-pack

- › Connectable to VRV heat recovery, heat pump and Conveni-pack
- › VRV is among the first DX systems suitable for connection to air curtains
- › Free-hanging model (F): easy wall mounted installation
- › Cassette model (C): mounted into a false ceiling leaving only the decoration panel visible
- › Recessed model (R): neatly concealed in the ceiling
- › A payback period of less than 1.5 years compared to installing an electric air curtain
- › Provides virtually free air curtain heating via recovered heat from indoor units in cooling mode (in case of VRV heat recovery)
- › Easy and quick to install at reduced costs since no additional water systems, boilers and gas connections are required
- › Maximum energy efficiency stemming from almost zero down flow turbulence, optimised air flow and the application of advanced discharge rectifier technology
- › Around 85% air separation efficiency, greatly reducing both heat loss and required indoor unit heating capacity

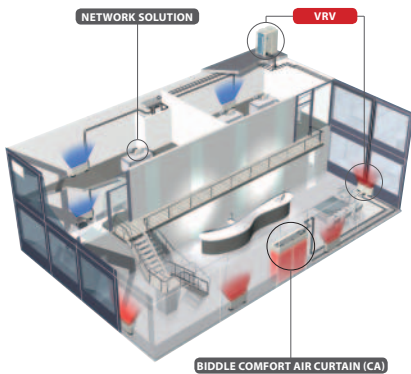
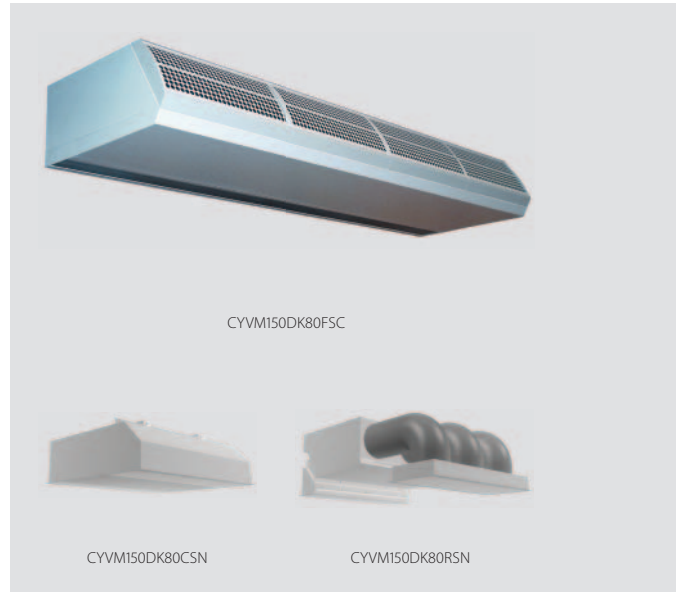

				Small				Medium			
				CYVS100DK80	CYVS150DK80	CYVS200DK100	CYVS250DK140	CYVM100DK80	CYVM150DK80	CYVM200DK100	CYVM250DK140
				*BN/*SN	*BN/*SN	*BN/*SN	*BN/*SN	*BN/*SN	*BN/*SN	*BN/*SN	*BN/*SN
Heating capacity	Speed 3		kW	7.40	9.0	11.6	16.2	9.2	11.0	13.4	19.9
Power input	Fan only	Nom.	kW	0.23	0.35	0.46	0.58	0.37	0.56	0.75	0.94
	Heating	Nom.	kW	0.23	0.35	0.46	0.58	0.37	0.56	0.75	0.94
Delta T	Speed 3		K	19	15		16	17	14	13	15
Casing	Colour	BN: RAL9010 / SN: RAL9006									
Dimensions	Unit	Height F/C/R	mm	270/270/270							
		Width F/C/R	mm	1,000/1,000/1,048	1,500/1,500/1,548	2,000/2,000/2,048	2,500/2,500/2,548	1,000/1,000/1,048	1,500/1,500/1,548	2,000/2,000/2,048	2,500/2,500/2,548
		Depth F/C/R	mm	590/821/561							
Required ceiling void >			mm	420							
Door height	Max.		m	2.3 (1) / 2.15 (2) / 2.0 (3)	2.3 (1) / 2.15 (2) / 2.0 (3)	2.3 (1) / 2.15 (2) / 2.0 (3)	2.3 (1) / 2.15 (2) / 2.0 (3)	2.5 (1) / 2.4 (2) / 2.3 (3)	2.5 (1) / 2.4 (2) / 2.3 (3)	2.5 (1) / 2.4 (2) / 2.3 (3)	2.5 (1) / 2.4 (2) / 2.3 (3)
Door width	Max.		m	1.0	1.5	2.0	2.5	1.0	1.5	2.0	2.5
Weight	Unit		kg	56	66	83	107	57	73	94	108
Fan-Air flow rate	Heating	Speed 3	m ³ /h	1,164	1,746	2,328	2,910	1,605	2,408	3,210	4,013
Sound pressure level	Heating	Speed 3	dB(A)	47	49	50	51	50	51	53	54
Refrigerant	Type / GWP	R-410A / 2,087.5									
Piping connections	Liquid/OD/Gas/OD		mm	9.52/16.0			9.52/19.0	9.52/16.0			9.52/19.0
Required accessories (should be ordered separately)		Daikin wired remote control (BRC1E52A/B or BRC1D52)									
Power supply	Voltage		V	230							

				Large			
				CYVL100DK125*BN/*SN	CYVL150DK200*BN/*SN	CYVL200DK250*BN/*SN	CYVL250DK250*BN/*SN
Heating capacity	Speed 3		kW	15.6	23.3	29.4	31.1
Power input	Fan only	Nom.	kW	0.75	1.13	1.50	1.88
	Heating	Nom.	kW	0.75	1.13	1.50	1.88
Delta T	Speed 3		K		15	14	12
Casing	Colour	BN: RAL9010 / SN: RAL9006					
Dimensions	Unit	Height F/C/R	mm	370/370/370			
		Width F/C/R	mm	1,000/1,000/1,048	1,500/1,500/1,548	2,000/2,000/2,048	2,500/2,500/2,548
		Depth F/C/R	mm	774/1,105/745			
Required ceiling void >			mm	520			
Door height	Max.		m	3.0 (1) / 2.75 (2) / 2.5 (3)	3.0 (1) / 2.75 (2) / 2.5 (3)	3.0 (1) / 2.75 (2) / 2.5 (3)	3.0 (1) / 2.75 (2) / 2.5 (3)
Door width	Max.		m	1.0	1.5	2.0	2.5
Weight	Unit		kg	76	100	126	157
Fan-Air flow rate	Heating	Speed 3	m ³ /h	3,100	4,650	6,200	7,750
Sound pressure level	Heating	Speed 3	dB(A)	53	54	56	57
Refrigerant	Type / GWP	R-410A / 2,087.5					
Piping connections	Liquid/OD/Gas/OD		mm	9.52/16.0	9.52/19.0	9.52/22.0	
Required accessories (should be ordered separately)		Daikin wired remote control (BRC1E52A/B or BRC1D52)					
Power supply	Voltage		V	230			

(1) Favorable conditions: covered shopping mall or revolving door entrance (2) Normal conditions: little direct wind, no opposite open doors, building with ground floor only (3) Unfavorable conditions: location at a corner or square, multiple floors and/or open stairway

Options & accessories - Ventilation & hot water

		VAM150FC	VAM250FC	VAM350FC	VAM500FC	VAM650FC
Dust filters	EN779 Medium M6	-	-	EKAFV50F6	EKAFV50F6	EKAFV80F6
	EN779 Fine F7	-	-	EKAFV50F7	EKAFV50F7	EKAFV80F7
	EN779 Fine F8	-	-	EKAFV50F8	EKAFV50F8	EKAFV80F8
Silencer	Model name	-	-	-	KDDM24B50	KDDM24B100
	Nominal pipe Diameter (mm)	-	-	-	200	200
CO ₂ sensor		-	-	BRYMA65	BRYMA65	BRYMA65
VH electrical heater for VAM		VH1B	VH2B	VH2B	VH3B	VH3B

Individual control systems	VAM-FC	VKM-GB(M)
Wired remote control	BRC1E52A/B / BRC1D52	BRC1E52A/B / BRC1D52
VAM wired remote control	BRC301B61	-

Centralised control systems	VAM-FC	VKM-GB(M)
Centralised remote control	DCS302C51	DCS302C51
Unified ON/OFF control	DCS301B51	DCS301B51
Schedule timer	DST301B51	DST301B51
Intelligent Touch Manager	DCM601A51	DCM601A51
Modbus DIII adapter	EKMBDXA7V1	EKMBDXA7V1

Others	VAM150-250FC	VAM350-2000FC	VKM-GB(M)
Wiring adapter for electrical appendices (note 7)	KRP2A51	KRP2A51 (note 3)	BRP4A50A (note 4/5)
Adapter PCB for humidifier	KRP50-2	KRP1C4 (note 4/6)	BRP4A50A (note 4/5)
Adapter PCB for 3rd party heater	BRP4A50	BRP4A50A (note 4/5)	BRP4A50A (note 4/5)
Remote sensor	-	-	-

Notes

- (1) Cool/heat selector required for operation
- (2) Do not connect the system to DIII-net devices (Intelligent controller, Intelligent Manager, LonWorks interface, BACnet interface ...).
- (3) Installation box KRP1BA101 needed.
- (4) Fixing plate EKMPVAM additionally needed for VAM1500-2000FB.
- (5) 3rd party heater and 3rd party humidifier cannot be combined
- (6) Installation box KRP50-2A90 needed.
- (7) For external control and monitoring (ON/OFF control, operation signal, error indication)

	VH electrical heater for VAM
Supply voltage	220/250V ac 50/60 Hz. +/-10%
Output current (maximum)	19A at 40°C (ambient)
Temperature sensor	5k ohms at 25°C (table 502 1T)
Temperature control range	0 to 40°C / (0-10V 0-100%)
Run on timer	Adjustable from 1 to 2 minutes (factory set at 1.5 minutes)
Control fuse	20 X5 mm 250 m A
LED indicators	Power ON - Yellow Heater ON - Red (solid or flashing, indicating pulsed control) Airflow fault - Red
Mounting holes	98mm X 181mm centres 5 mm ø holes
Maximum ambient adjacent to terminal box	35°C (during operation)
Auto high temp. cutout	100°C Pre-set
Man. reset high temp. cutout	125°C Pre-set
Run relay	1A 120V AC or 1A 24V DC
BMS setpoint input	0-10VDC

Vh electrical heater for vam		vH1B	VH2B	VH3B	VH4B	VH4/AB	VH5B
Capacity	kW	1	1	1	1.5	2.5	2.5
Duct diameter	mm	100	150	200	250	250	350
Connectable VAM		VAM150FC	VAM250FC	VAM500FC	VAM800FC	VAM800FC	VAM1500FC
		-	VAM350FC	VAM650FC	VAM1000FC	VAM1000FC	VAM2000FC

VAM800FC	VAM1000FC	VAM1500FC	VAM2000FC	VKM50GB(M)	VKM80GB(M)	VKM100GB(M)
EKAFV80F6	EKAFV100F6	EKAFV100F6 x2	EKAFV100F6 x2	-	-	-
EKAFV80F7	EKAFV100F7	EKAFV100F7 x2	EKAFV100F7 x2	-	-	-
EKAFV80F8	EKAFV100F8	EKAFV100F8 x2	EKAFV100F8 x2	-	-	-
KDDM24B100	KDDM24B100	KDDM24B100 x2	KDDM24B100 x2	-	KDDM24B100	KDDM24B100
250	250	250	250	-	250	250
BRYMA100	BRYMA100	BRYMA200	BRYMA200	BRYMA65	BRYMA100	BRYMA200
VH4B / VH4/AB	VH4B / VH4/AB	VH5B	VH5B	-	-	-

EKEQFCBA ²	EKEQDCB ²	EKEQMCBA ²
BRC1E52A/B / BRC1D52	BRC1E52A/B / BRC1D521	BRC1E52A/B / BRC1D521
-	-	-

EKEQFCBA ²	EKEQDCB ²	EKEQMCBA ²
-	-	-
-	-	-
-	-	-
DCM601A51	DCM601A51	DCM601A51
EKMBDXA7V1	EKMBDXA7V1	EKMBDXA7V1

EKEQFCBA ²	EKEQDCB ²	EKEQMCBA ²
-	-	-
-	-	-
-	-	-
-	KRCS01-1	-

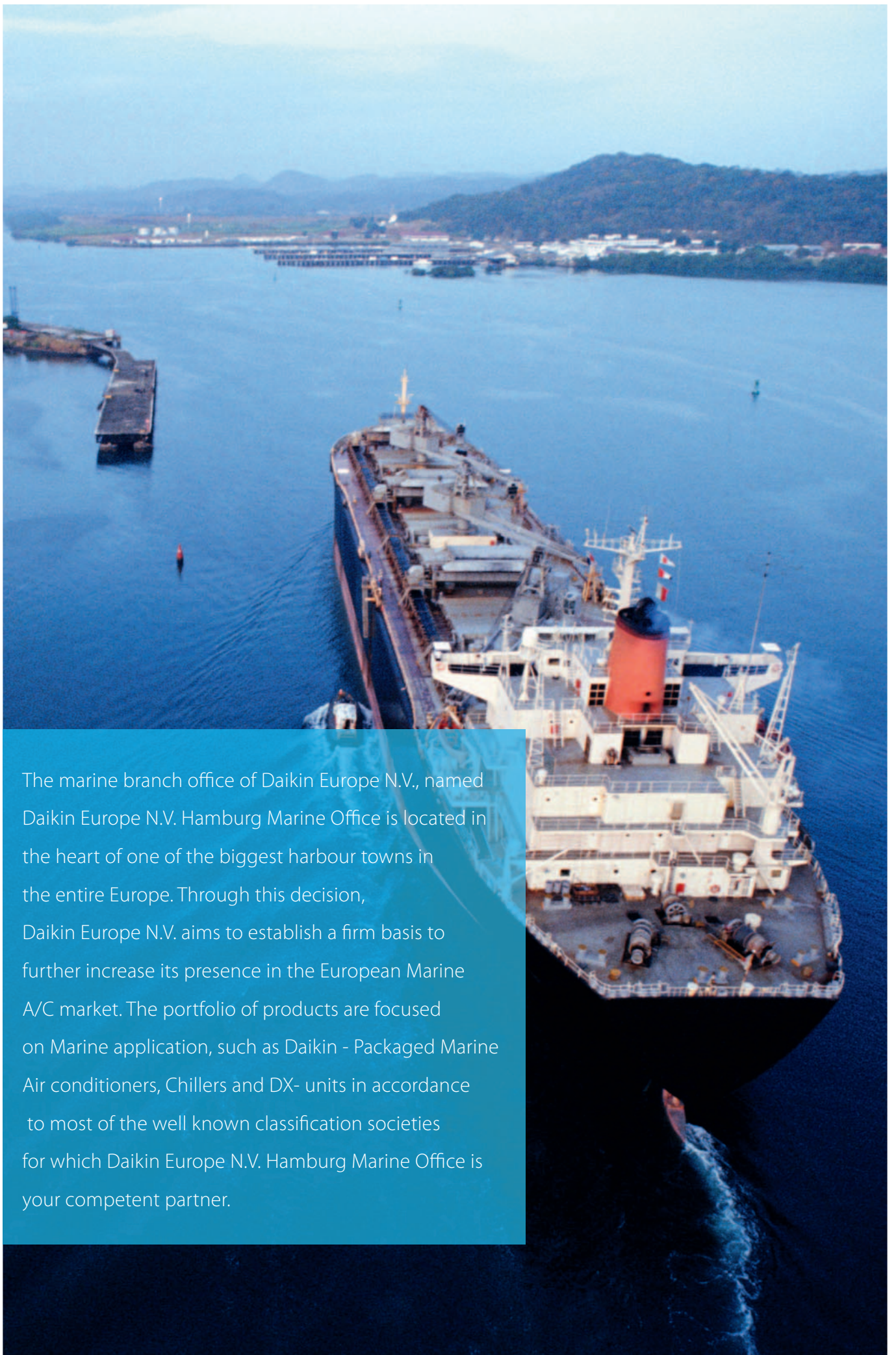

The marine branch office of Daikin Europe N.V., named Daikin Europe N.V. Hamburg Marine Office is located in the heart of one of the biggest harbour towns in the entire Europe. Through this decision, Daikin Europe N.V. aims to establish a firm basis to further increase its presence in the European Marine A/C market. The portfolio of products are focused on Marine application, such as Daikin - Packaged Marine Air conditioners, Chillers and DX- units in accordance to most of the well known classification societies for which Daikin Europe N.V. Hamburg Marine Office is your competent partner.

Daikin Marine Type Deck Units

- › Energy saving
- › Compact design
- › Refrigerants R-404A - R-407C
- › Economical maintenance
- › Easy installation
- › Hermetic scroll compressor
- › Minimum piping and field work required
- › High performance reliability
- › Lesser refrigerant volum with leak proof hermetic structure
- › High static pressure fan facilitates the use of long ducts
- › Quiet, less vibration operation makes it suitable for installation in accomodation areas

Optional customized modifications:

- › Remote controls
- › Electrical heater
- › Data bus interfaces
- › Air plenum or duct connection
- › Higher external static pressure
- › Cooling water regulating valve
- › Higher air volume



USP~HR1 / USP~H

Daikin Marine Type Packaged Series

- › Excellent durability
- › Hermetic scroll compressor
- › Light weight design
- › Refrigerants: R-404A - R-407C
- › Resilient structure specially designed for marine applications
- › Abundant modification parts assures various applications
- › Wide operation range
- › Easy transportation and installation
- › Energy-saving
- › Complete set of spare parts provided for certain models

Optional customized modifications:

- › Remote controls
- › Electrical heater
- › Data bus interfaces
- › Air plenum or duct connection
- › Higher external static pressure
- › Cooling water regulating valve
- › Higher air volume



USF*(A)

Daikin Marine Type Galley Series

- › Respond to a wide temperature range
- › High efficient operation
- › Outstanding durable design
- › Easy transportation and installation
- › Excellent performance reliability
- › Spare parts are provided as standard accessories
- › Hermetic scroll compressor
- › High static pressure system
- › R-404A
- › Complete set of spare parts provided for certain models

Optional customized modifications:

- › Remote controls
- › Electrical heater
- › Data bus interfaces
- › Air plenum or duct connection
- › Higher external static pressure
- › Cooling water regulating valve
- › Higher air volume



RHSD~A / RKS~FR Unit

Daikin Marine Type Small Size Condensing

RHSD-A (R-134a):

- › A semi-hermetic reciprocating compressor with proven reliability
- › Saved maintenance work around compressor (without V belts & shaft seal)

RKS-FR (R-404A):

- › An open type reciprocating compressor of optimum design for R-404A
- › Equal installation & maintenance as R-22



A photograph showing a row of Daikin chillers installed on a rooftop. The chillers are mounted on a metal frame and are surrounded by gravel. The background shows a clear blue sky and a building with a glass facade. A blue text box is overlaid on the right side of the image.

Daikin chillers offer the ultimate in reliability and flexibility — a reflection of the advanced technology inherent within them. Daikin chillers represent the sure and safe route to a comfortable environment and a process cooling solution that is clean and consistent.

Chillers

Why choose Daikin chillers 316

Products overview -
air cooled and condensing units 320

Products overview -
water cooled and condenserless units 322

Air cooled chillers (Cooling only)

EWAQ-ADVP	324
EWAQ-ACV3/ACW1	325
EWAQ-BAWN/BAWP	326
NEW EWAQ-G-	328
EWAQ-E-	332
EWAQ-F-	334
EWAQ-GZ	338
EWAD-E-	340
EWAD-D-	342
EWAD-C-	350
EWAD-CZ	356
EWAD-CF	358
EWAD-TZ	362

Air cooled chillers (Heat pump)

EWYQ-ADVP	366
EWYQ-ACV3/ACW1	367
EWYQ-BAWN/BAWP	368
SEHVX-AAW/SERHQ-AAW1	369
NEW EWYQ-G-	370
EWYQ-F-	372
EWYD-BZ	374

Air cooled condensing unit

ERAD-E-	376
---------	-----

Water cooled chillers

EWWQ-B-	378
EWWP-KBW1N	380
NEW EWHQ-G-	382
NEW EWWQ-G-	383
NEW EWWQ-L-	384
EWWD-G-	386
EWWD-I-	388
EWWD-J-	390
EWWD-H-	391

Condenserless chillers

EWLP-KBW1N	392
NEW EWLQ-G-	393
NEW EWLQ-L-	394
EWLD-J-	395
EWLD-G-	396
EWLD-I-	397

Water cooled centrifugal chillers

EWWD-FZXS	398
DWSC / DWDC	399



Daikin chillers

Why choose Daikin chillers?

The simple answer is that, as the market leaders, the performance of our equipment is second to none. From the smallest chillers to the very largest, our quality control and attention detail is absolute. Our systems have the **most advanced technologies**, deliver **the highest energy efficiencies** and **lowest running costs**, and are the gold standard for reliability and performance.

The widest and most flexible chiller portfolio

- › From the smallest mini chiller for residential use to the largest chiller for district cooling
- › Tailor made solutions based on the most advanced technologies

Worldwide experience in chiller design and manufacturing

- › World's most advanced facilities for air conditioning research and development: the Applied Development Center in Minneapolis, Minnesota
- › Inhouse development and manufacturing of chiller main components (compressors, fans, condenser coils, software, etc...)

The highest efficiency for every installation

- › The lowest total cost of ownership and fast payback time

Quality and reliability

- › Daikin's integrated zero defect policy ensures quality of components and finished products
- › Each Daikin chiller is factory run-tested and subjected to quality audit before shipment

Benefits for installers

- › Plug & play solutions
- › Maximum serviceability
- › Ideal solutions for retrofit projects

Benefits for consultants

- › Energy efficient solutions without compromising on reliability and performance
- › Latest technology embedded in all our products

Benefits for end users

- › Remarkable savings on running costs
- › Eurovent and AHRI certification

Chiller selection software

- › The Daikin chiller selection software allows consultants and building engineers to select proper units based on application type, efficiency and sound level and required capacity. The tool presents all possible series and generates for selected units a detailed technical data book.

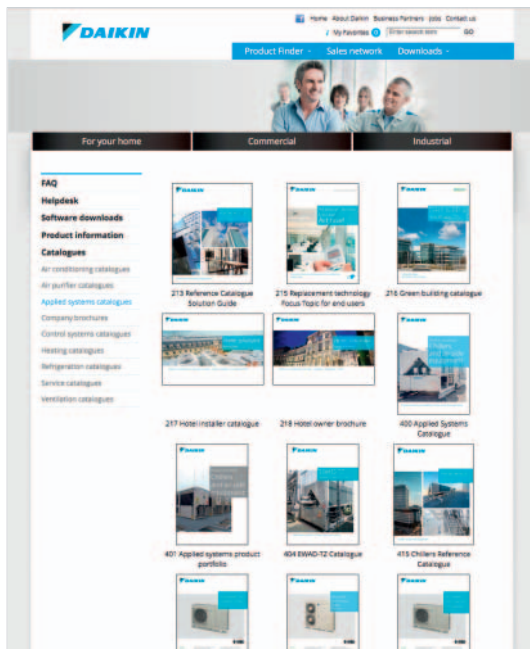

Supporting tools

NEW Business portal

- › Experience our new extranet that thinks with you at my.daikin.eu
- › Find information in seconds via a powerful search
- › Customise the options so you see only info relevant for you
- › Access via mobile device or desktop

Internet

- › See an overview of our references www.daikineurope.com/references

Literature

- › Check some of all our literature for our professional network and end-customers (daikineurope.com/support-and-manuals/catalogues/applied-systems/)



PRINTING COMPANY APPLICATION



AIR COOLED CHILLER INSTALLATION



AIR COOLED CHILLER INSTALLATION

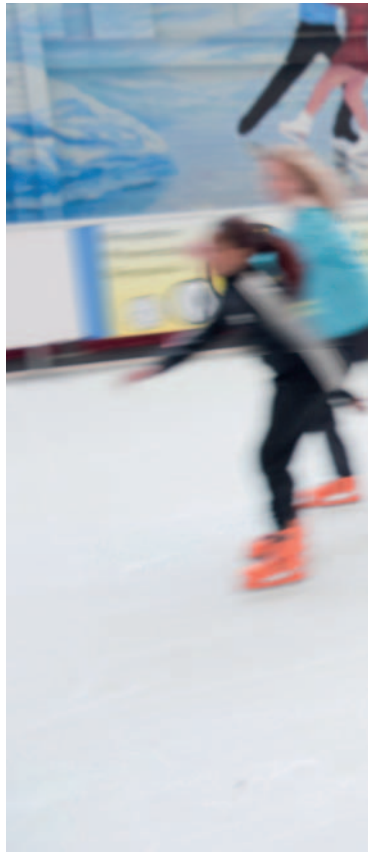

EWAQ-GZXR
INSTALLATION



DATA CENTER
APPLICATION

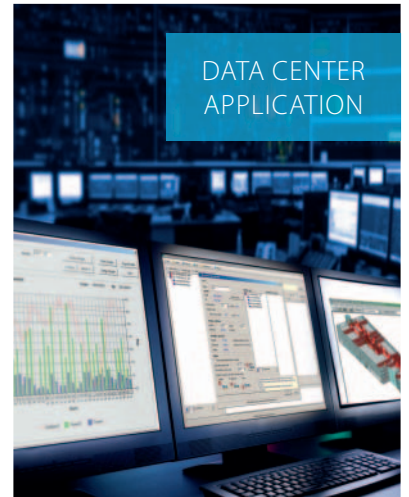





















PROCESS COOLING
APPLICATION



ICE RINK
APPLICATION



Products overview

	Refrigerant type *	Refrigerant circuits	Inverter	Free cooling	Compressor			Water heat exchanger		Efficiency version				Sound version			
					Swing	Scroll	Screw	Plate **	Single pass shell and tube	Standard	High	Premium	High ambient	Standard	Low	Reduced	Extra low
Cooling only																	
EWAQ~ADVP	 R-410A	1	●		●			●		●				●			
EWAQ~ACV3/ACW1	 R-410A	1	●			●		●		●				●			
EWAQ~BA*	 R-410A	1	●			●		●		●				●			
EWAQ~G- NEW	 R-410A	1				●		●		●	●			●		●	
EWAQ~E-	 R-410A	1				●		●			●			●	●	●	
EWAQ~F-	 R-410A	2				●		●		●	●			●	●	●	
EWAQ~GZ	 R-410A	1-2	●			●		●			●			●		●	
EWAD~E-	 R-134a	1					●	●		●				●	●		
EWAD~D-	 R-134a	2					●	●	●	●	●		●	●	●	●	
EWAD~C-	 R-134a	2-3					●	●	●	●	●	●		●	●	●	
EWAD~CZ	 R-134a	2-3	●				●	●			●			●	●	●	
EWAD~CF	 R-134a	2		●			●	●			●			●	●	●	
EWAD~TZ	 R-134a	1-2	●				●	●	●	●				●		●	
Heat pump																	
EWYQ~ADVP	 R-410A	1	●		●			●		●				●			
EWYQ~ACV3/ACW1	 R-410A	1	●			●		●		●				●			
EWYQ~BA*	 R-410A	1	●			●		●		●				●			
SEHVX-AAW SERHQ-AAW1	 R-410A	1	●			●		●		●				●			
EWYQ~G- NEW	 R-410A	1				●		●			●			●		●	
EWYQ~F-	 R-410A	1-2				●		●			●			●	●	●	
EWYD~BZ	 R-134a	2-3	●				●	●	●	●				●	●		
Condensing unit																	
ERAD~E-	 R-134a	1					●			●				●	●		







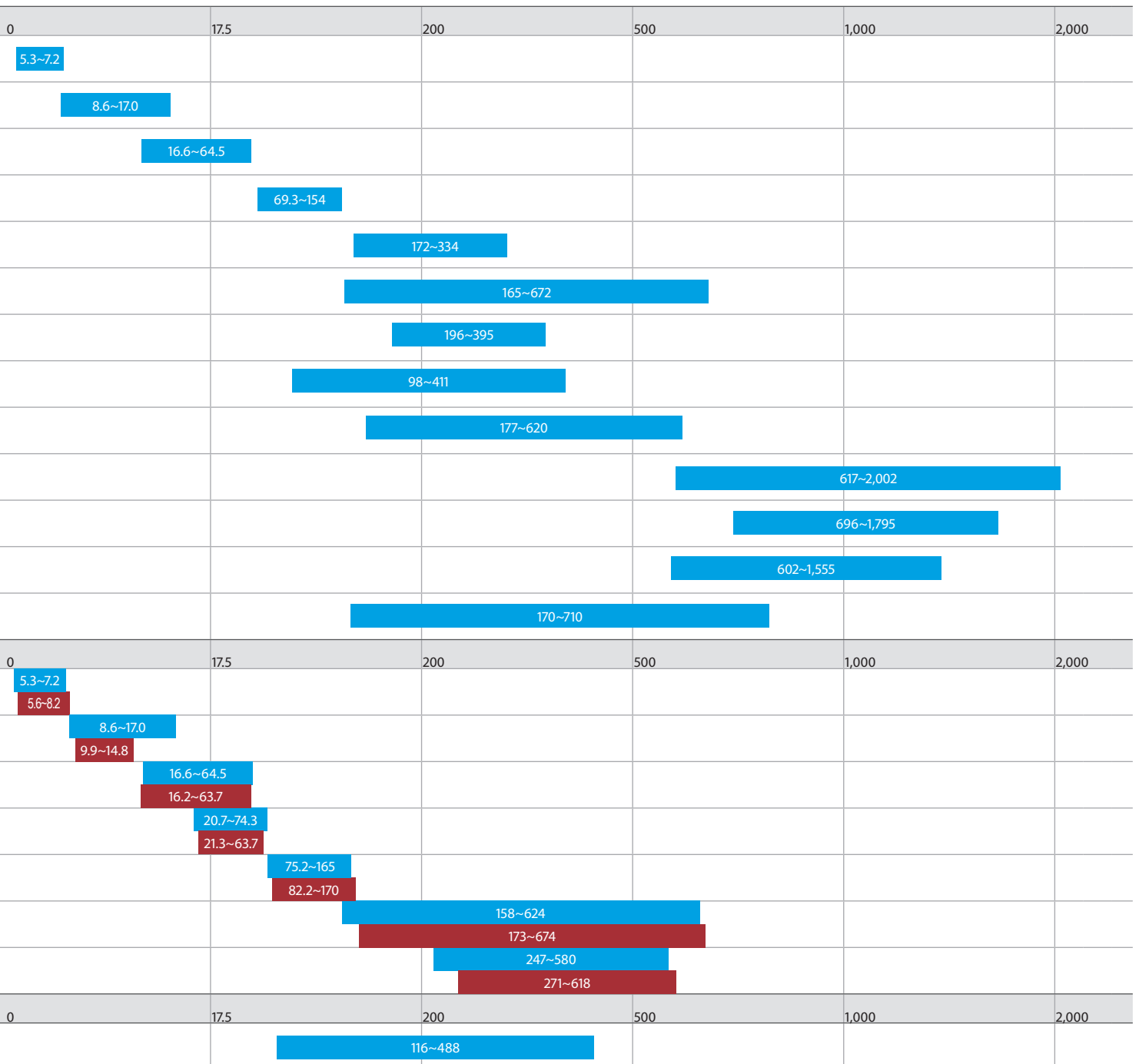

















* (GWP) : R-410A (2087.5), R-134a (1430)

** BPHE: Brazed plate heat exchanger

Cooling capacity (kW)
Heating capacity (kW)



Products overview

	Refrigerant Type*	Refrigerant circuits	Inverter 	Compressor			Water heat exchanger		Efficiency version		Sound version
				Scroll 	Screw 	Centrifugal 	Plate** 	Single pass shell and tube 	Standard	High	Standard
Water cooled chillers (Cooling only & Heating only)											
EWWP~KBW1N 	R-407C	1-2-4-6		●					●		●
EWHQ~G- NEW 	R-410A	1		●			●				
EWQ~G- NEW 	R-410A	1		●			●		●		●
EWQ~L- NEW 	R-410A	2		●			●		●		●
EWWD~J- 	R-134a	1-2			●		●		●		●
EWWD~G- 	R-134a	1-2			●			●	●	●	●
EWWD~I- 	R-134a	1-2-3			●			●	●	●	●
EWWD~H- 	R-134a	1			●			● Flooded		●	●
Water cooled chillers (Cooling only)											
EWQ~B- 	R-410A	1-2			●			●	●	●	●
Condenserless chillers											
EWLP~KBW1N 	R-407C	1-2		●			● BPHE		●		●
EWLQ~G- NEW 	R-410A	1		●			●		●		●
EWLQ~L- NEW 	R-410A	2		●			●		●		●
EWLD~J- 	R-134a	1-2			●		●		●		●
EWLD~G- 	R-134a	1-2			●			●	●		●
EWLD~I- 	R-134a	1-2-3			●			●	●		●
Water cooled centrifugal chillers											
EWWD~FZ 	R-134a	1	●			●		● Flooded		●	●
DWSC DWDC 	R-134a		optional			●	● BPHE			●	●
6,000 RT CENTRIFUGAL 	R-134a					●				●	●

* (GWP) : R-410A (2087.5), R-134a (1430), R-407C (1773.9)

** BPHE: Brazed plate heat exchanger

Cooling capacity (kW)
Heating capacity (kW)

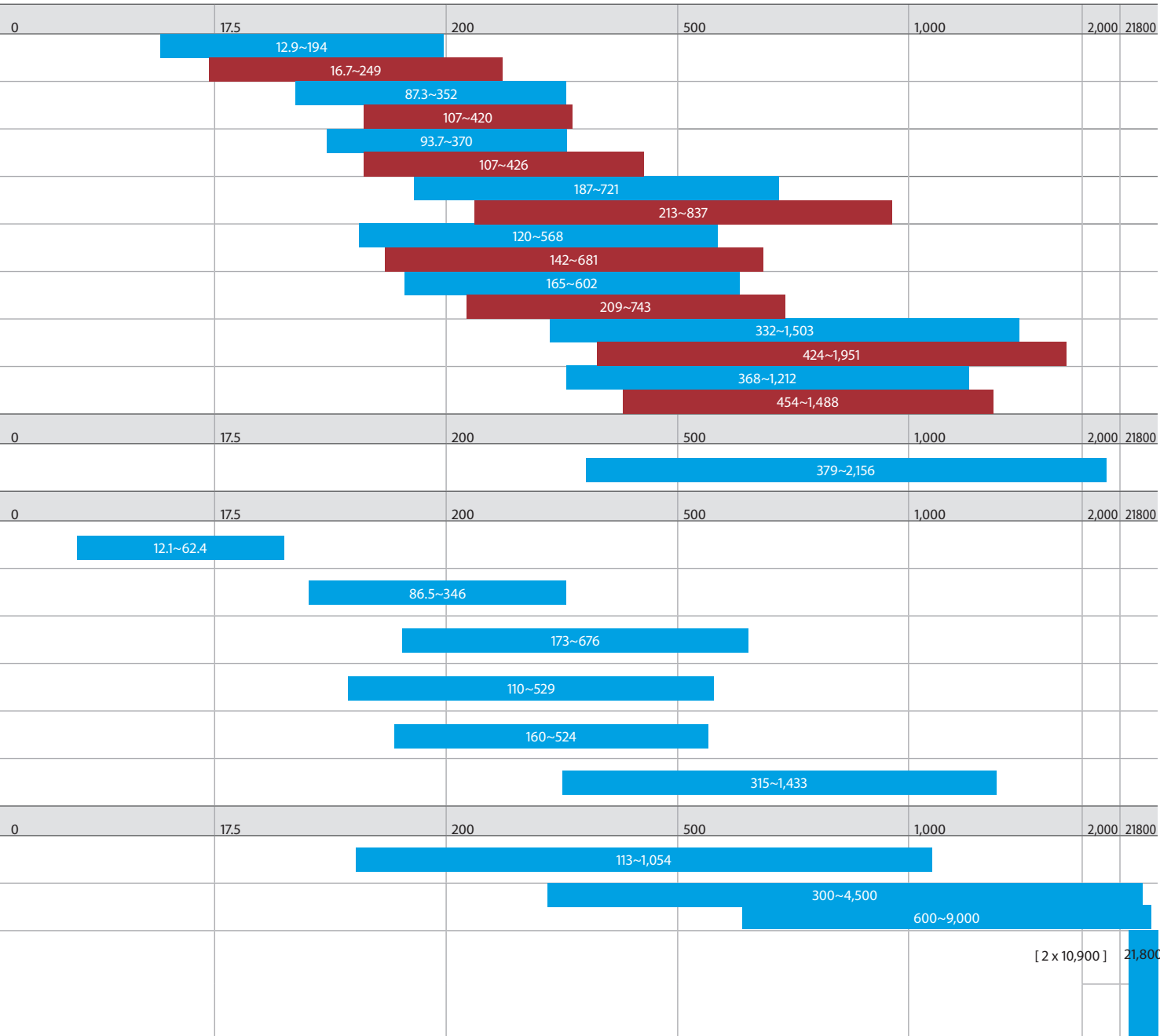

Air cooled mini inverter chiller

- › Inverter technology to ensure low sound values and **leader-of-class ESEER**
- › Wide operating range
- › Easy 'plug and play' installation
- › Single phase power supply and low starting currents make the unit ideal **for residential applications**
- › **Built-in hydronic module:** no buffer tank required and a standard pump and main switch are included



Cooling only				EWAQ-ADVP	005	006	007
Cooling capacity	Nom.				5.28 (1)	6.08 (1)	7.18 (1)
Power input	Cooling	Nom.			1.94 (1)	2.40 (1)	3.00 (1)
Capacity control	Method				Inverter controlled		
EER					2.72 (1)	2.53 (1)	2.39 (1)
Dimensions	Unit	Height				805	
		Width				1,190	
		Depth				360	
Weight	Unit					100	
	Operation weight					104	
Water heat exchanger	Type					Brazen plate	
	Water flow rate	Cooling	Nom.		14.9	17.2	20.4
Air heat exchanger	Type					Tube type	
Hydraulic components	Expansion vessel	Volume				6	
Compressor	Type					Hermetically sealed swing compressor	
	Quantity					1	
Fan	Type					Propeller fan	
	Quantity					1	
Sound power level	Cooling	Nom.			62		63
Sound pressure level	Cooling	Nom.			48		50
Operation range	Water side	Cooling	Min.-Max.	°CDB		5~20	
	Air side	Cooling	Min.-Max.	°CDB		10~43	
Refrigerant	Type / GWP					R-410A / 2,087.5	
	Control					Inverter	
	Circuits	Quantity				1	
Refrigerant charge	Per circuit					1.7	
						3.5	
Water circuit	Piping connections diameter					1" MBSP	
Piping connections	Water heat exchanger drain					5/16 SAE flare	
Unit	Maximum running current					17.3	
Power supply	Phase/Frequency/Voltage					1~/50/230	

(1) Tamb 35°C - LWE 7°C (Dt: 5°C)

Air cooled mini inverter chiller

- › Inverter technology to ensure low sound values and **leader-of-class ESEER**
- › Wide operating range
- › Built-in hydronic module: no buffer tank required and a standard pump and main switch are included
- › Easy 'plug and play' installation
- › Single phase power supply **for residential applications**, three phase power supply model available **for light commercial applications**



Cooling only					EWAQ	009ACV3	010ACV3	011ACV3	009ACW1	011ACW1	013ACW1	
Cooling capacity	Nom.				kW	12.2 (1) / 8.6 (2)	13.6 (1) / 9.6 (2)	15.7 (1) / 11.1 (2)	12.9 (1) / 9.1 (2)	15.7 (1) / 11.1 (2)	17.0 (1) / 13.3 (2)	
Power input	Cooling	Nom.				kW	2.85 (1) / 2.83 (2)	3.41 (1) / 3.28 (2)	4.13 (1) / 3.90 (2)	3.08 (1) / 3.05 (2)	4.13 (1) / 3.90 (2)	5.52 (1) / 5.18 (2)
Capacity control	Method				Inverter controlled							
EER						4.27 (1) / 3.05 (2)	4.00 (1) / 2.93 (2)	3.79 (1) / 2.85 (2)	4.19 (1) / 2.99 (2)	3.79 (1) / 2.85 (2)	3.08 (1) / 2.57 (2)	
ESEER						4.31	4.30	4.33	4.43	4.44	4.36	
Dimensions	Unit	Height			mm	1,435						
		Width			mm	1,418						
		Depth			mm	382						
Weight	Unit				kg	180						
Water heat exchanger	Type				Brazed plate							
	Quantity				1							
	Water volume				l	1.01						
	Water flow rate	Cooling	Nom.		l/min	24.7	27.6	31.9	26.1	31.9	38.2	
Air heat exchanger	Type				Hi-XSS							
Hydraulic components	Expansion vessel		Volume		l	10						
Compressor	Type				Hermetically sealed scroll compressor							
	Quantity				1							
Fan	Type				Propeller fan							
	Quantity				2							
	Air flow rate	Cooling	Nom.		m ³ /min	96	100	97	-			
Fan motor	Speed	Cooling	Nom.		rpm	780						
		Steps				8						
Sound power level	Cooling	Nom.				64					66	
Sound pressure level	Cooling	Nom.				51					52	
		Cooling	Night quiet mode				45					46
Operation range	Water side	Cooling	Min.-Max.		°CDB	5~22						
	Air side	Cooling	Min.-Max.		°CDB	10~46						
Refrigerant	Type / GWP				R-410A / 2,087.5							
	Control				Electronic expansion valve							
Refrigerant charge	Circuits	Quantity				1						
		Per circuit				kg	2.95					
Water circuit	Piping connections diameter				TCO ₂ eq	6.2						
	Piping				inch	G 5/4" (female)						
Power supply	Phase/Frequency/Voltage				Hz/V	1~/50/230			3N~/50/400			
						5/4"						

(1) Underfloor program: cooling Ta 35°C - LWE 18°C (Dt: 5°C) (2) Fan coil program: cooling Ta 35°C - LWE 7°C (Dt: 5°C)

Air cooled scroll inverter chiller

- › High efficiency with **leader-of-class ESEER**
- › Minimal starting currents and short payback times
- › No buffertank required for standard applications
- › **Large operation range** (ambient temperature up to 43°C)
- › A modbus gateway (RTD-W) can be installed per unit in order allow the control and monitoring by a Daikin controller or a third-party BMS, which will increase further the efficiency of the system
- › All systems that are connected with RTD-W can be controlled and **monitored centrally** with the master/slave control kit: the sequencing controller EKCC-W



Cooling only		EWAQ-BAWN/BAWP			016		021		025		032		040		050		064						
Cooling capacity	Nom.	kW			17.4 (1) / 16.6 (2)		21.7 (1) / 20.7 (2)		25.8 (1) / 24.7 (2)		32.3 (1) / 30.9 (2)		43.4 (1) / 41.5 (2)		51.8 (1) / 49.7 (2)		64.5 (1) / 62.3 (2)						
Power input	Cooling	Nom. kW			5.60 (1) / 5.80 (2)		7.25 (1) / 7.59 (2)		9.29 (1) / 9.74 (2)		13.0 (1) / 13.5 (2)		14.7 (1) / 15.4 (2)		18.8 (1) / 19.7 (2)		26.4 (1) / 27.4 (2)						
Capacity control	Method	Inverter controlled																					
	Minimum capacity	%			25																		
EER		3.11 (1) / 2.86 (2)		2.99 (1) / 2.73 (2)		2.78 (1) / 2.54 (2)		2.48 (1) / 2.29 (2)		2.95 (1) / 2.69 (2)		2.76 (1) / 2.52 (2)		2.44 (1) / 2.27 (2)									
ESEER		4.33 (1) / 4.21 (2)		4.08 (1) / 4.18 (2)		3.85 (1) / 4.04 (2)		3.39 (1) / 3.62 (2)		4.19 (1) / 4.24 (2)		3.96 (1) / 4.12 (2)		3.64 (1) / 3.78 (2)									
Dimensions	Unit	Height	mm			1,684																	
		Width	mm			1,371				1,684				2,358				2,980					
		Depth	mm			774								780									
Weight	Unit	kg			264		317		397		571		730										
		Operation weight			267		320		401		577		738										
Water heat exchanger	Type		Braze plate																				
	Water volume		l			1.9				2.9				3.8				5.7					
	Water flow rate	Cooling	Nom. l/min		50		62		74		93		124		148		185						
Air heat exchanger	Type		Hi-XSS																				
	Compressor		Type		Hermetically sealed scroll compressor																		
Fan	Quantity		1		2		3		4		6												
	Type		Axial																				
Sound power level	Quantity		1		2		4		6														
	Air flow rate	Cooling	Nom. m³/min		171		185		233		370		466										
Operation range	Cooling		Nom. dBA		78		80		81		83												
	Water side	Cooling	Min.-Max. °CDB		-10~20																		
Refrigerant	Air side		Cooling		Min.-Max. °CDB		-5~43																
	Type / GWP		R-410A / 2,087.5																				
Refrigerant charge	Control		Electronic expansion valve																				
	Circuits		Quantity			1																	
	Per circuit		kg			7.6				9.6				15.2				19.2					
Water circuit	Piping connections diameter		inch			1-1/4" (female)				2" (female)													
	Piping		inch			1-1/4"				1-1/2"													
Unit	Maximum starting current		A			0		77.7		78.7		88.7		99.8		101.9		120.7					
	Maximum running current		A			22.2		25.3		26.4		35.2		47.4		49.6		67.2					
Power supply	Phase/Frequency/Voltage		Hz/V			3N~/50/400																	

(1) EWAQ-BAWN: Version without pump (2) EWAQ-BAWP: Version with pump



Air cooled multi-scroll chiller, standard efficiency, standard sound

- › Single refrigerant circuit (2 scroll compressors) with single evaporator
- › Compact design to allow easy indoor installation or retrofit operations
- › Micro channel heat exchanger technology reduces the amount of refrigerant used in the system, lowering environmental impact
- › Partial and total heat recovery option available
- › Stainless steel plate heat exchanger

Cooling only				EWAQ-G-SS		075	085	100	110	120	140	155
Cooling capacity	Nom.		kW	74.7	84.2	96.7	107	117	139	154		
Power input	Cooling		Nom.	kW	27.7	31.2	35.0	39.5	43.4	51.1	57.2	
Capacity control	Method				Step							
	Minimum capacity		%	50	44	50	44	50	43	50		
EER				2.70		2.76		2.70		2.73		2.70
ESEER				4.11	4.23	4.04	4.12	3.91	4.20	4.06		
IPLV				4.79	4.97	4.78	4.86	4.66	4.92	4.78		
Dimensions	Unit	Height	mm	1,800								
		Width	mm	1,195								
		Depth	mm	2,140	2,680			3,200				
Weight	Unit			kg	681	792	923	953	982	1,037	1,066	
	Operation weight				kg	692	802	934	963	993	1,054	1,085
Water heat exchanger	Type		Brazen plate									
	Water flow rate	Cooling	Nom.	l/s	3.6	4.0	4.6	5.1	5.6	6.7	7.4	
	Water pressure drop	Cooling	Nom.	kPa	15.5	27.3	36.9	31.6	36.0	27.5	25.8	
	Water volume				l	5.60	4.90		5.60		8.10	9.40
Air heat exchanger	Type		Microchannel									
Compressor	Type		Scroll compressor									
	Quantity		2									
Fan	Type		Direct propeller									
	Quantity		4		6				8			
	Air flow rate	Nom.		l/s	6,017	6,444	9,029			12,008		
	Speed				rpm	1,360						
Sound power level	Cooling	Nom.		dBA	83	85	87	89				
Sound pressure level	Cooling	Nom.		dBA	66	68	69	71				
Operation range	Air side	Cooling	Min.-Max.	°CDB	-10~42							
	Water side	Cooling	Min.-Max.	°CDB	-10~15							
Refrigerant	Type / GWP		R-410A / 2,087.5									
	Circuits	Quantity		1								
Refrigerant charge	Per circuit				kg	8.0		10.0		12.0		
					TCO ₂ eq	16.7		20.9		25.1		
Piping connections	Evaporator water inlet/outlet (OD)		2" 1/2									
Unit	Starting current	Max		A	208	259	266	313	321	361	374	
	Running current	Cooling	Nom.	A	54	58	62	70	79	89	102	
		Max				A	64	69	77	84	92	108
Power supply	Phase/Frequency/Voltage				Hz/V	3~/50/400						

Air cooled multi-scroll chiller, standard efficiency, reduced sound



EWAQ-G-SS/SR

Cooling only				EWAQ-G-SR		075	085	100	110	120	140	155	
Cooling capacity	Nom.			kW		69.3	78.9	91.0	99.7	109	130	143	
Power input	Cooling		Nom.	kW		29.4	33.1	36.8	42.0	46.3	54.0	61.2	
Capacity control	Method		Step										
	Minimum capacity			%		50	44	50	44	50	43	50	
EER					2.36	2.38	2.47	2.38	2.35	2.42	2.34		
ESEER					3.94	4.12	3.94	4.02	3.74	4.12	3.88		
IPLV					4.67	4.85	4.71	4.78	4.50	4.85	4.61		
Dimensions	Unit	Height		mm		1,800							
		Width		mm		1,195							
		Depth		mm		2,140	2,680			3,200			
Weight	Unit		kg		711	822	953	983	1,012	1,067	1,096		
	Operation weight		kg		722	832	963	993	1,023	1,084	1,115		
Water heat exchanger	Type		Brazen plate										
	Water flow rate	Cooling	Nom.	l/s		3.3	3.8	4.4	4.8	5.2	6.2	6.9	
	Water pressure drop	Cooling	Nom.	kPa		13.3	24.0	32.6	27.6	31.1	24.1	22.2	
	Water volume		l		5.58	4.86			5.60		8.10	9.36	
Air heat exchanger	Type		Microchannel										
Compressor	Type		Scroll compressor										
	Quantity		2										
Fan	Type		Direct propeller										
	Quantity		4		6			8					
	Air flow rate	Nom.	l/s		4,523	5,046	6,787			9,023			
	Speed		rpm		1,108								
Sound power level	Cooling	Nom.	dBA		79	82	84	86					
Sound pressure level	Cooling	Nom.	dBA		62	65	66	68					
Operation range	Air side	Cooling	Min.~Max.	°CDB		-10~42							
	Water side	Cooling	Min.~Max.	°CDB		-10~15							
Refrigerant	Type / GWP		R-410A / 2,087.5										
	Circuits	Quantity		1									
Refrigerant charge	Per circuit		kg		8.0	10.0			12.0				
			TCO ₂ eq		16.7	20.9			25.1				
Piping connections	Evaporator water inlet/outlet (OD)		2" 1/2										
Unit	Starting current		Max		A		207	258	266	313	320	360	374
	Running current	Cooling	Nom.	A		57	61	65	74	84	93	109	
		Max		A		63	69	76	84	91	107	121	
Power supply	Phase/Frequency/Voltage		Hz/V		3~/50/400								

Air cooled multi-scroll chiller, high efficiency, standard sound

- › Single refrigerant circuit (2 scroll compressors) with single evaporator
- › Compact design to allow easy indoor installation or retrofit operations
- › Micro channel heat exchanger technology reduces the amount of refrigerant used in the system, lowering environmental impact
- › Partial and total heat recovery option available
- › Stainless steel plate heat exchanger

Cooling only				EWAQ-G-XS	080	090	105	115	130	150
Cooling capacity	Nom.		kW	79.8	90.3	105	117	131	149	
Power input	Cooling		Nom. kW	25.8	29.0	33.8	37.7	42.3	48.1	
Capacity control	Method			Step						
	Minimum capacity		%	50	44	50	44	50	43	
EER				3.10	3.11	3.12		3.10		
ESEER				4.20	4.30	4.28	4.34	4.22	4.36	
IPLV				4.82	5.04	4.96	5.02	4.92	5.05	
Dimensions	Unit	Height	mm	1,800				1,820		
		Width	mm	1,195						
		Depth	mm	2,680	3,200			3,800		
Weight	Unit			kg	734	850	991	1,020	1,086	1,123
	Operation weight				kg	744	860	1,007	1,035	1,102
Water heat exchanger	Type			Braze plate						
	Water flow rate	Cooling	Nom.	l/s	3.8	4.3	5.0	5.6	6.3	7.1
	Water pressure drop	Cooling	Nom.	kPa	25.7	32.7	20.3	19.9	25.4	20.6
	Water volume				l	5.58	4.86		5.60	
Air heat exchanger	Type			Microchannel						
Compressor	Type			Scroll compressor						
	Quantity			2						
Fan	Type			Direct propeller						
	Quantity			6		8		10		
	Air flow rate	Nom.		l/s	9,029	9,498	12,008		15,046	
	Speed			rpm	1,360					
Sound power level	Cooling	Nom.		dBA	84	85	87	89		
Sound pressure level	Cooling	Nom.		dBA	66	68	69	71		
Operation range	Air side	Cooling	Min.~Max.	°CDB	-10~-45					
	Water side	Cooling	Min.~Max.	°CDB	-10~-15					
Refrigerant	Type / GWP			R-410A / 2,087.5						
	Circuits	Quantity		1						
Refrigerant charge	Per circuit			kg	8.0		10.0		12.0	
				TCO ₂ eq	16.7		20.9		25.1	
Piping connections	Evaporator water inlet/outlet (OD)			2" 1/2						
Unit	Starting current		Max	A	210	261	268	315	324	362
	Running current	Cooling	Nom.	A	52	56	61	69	76	87
		Max				A	65	71	78	86
Power supply	Phase/Frequency/Voltage			Hz/V	3~/50/400					

Air cooled multi-scroll chiller, high efficiency, reduced sound



EWAQ-G-XS/XR

Cooling only				EWAQ-G-XR	080	090	105	130	115	150		
Cooling capacity	Nom.			kW	76.0	86.0	100	125	110	141		
Power input	Cooling	Nom.		kW	26.4	29.9	34.7	43.3	39.0	49.8		
Capacity control	Method			Step								
	Minimum capacity			%	50	44	50		44	43		
EER				2.88		2.89		2.88		2.83		
ESEER				4.18	4.29	4.27	4.21	4.31	4.33			
IPLV				4.85	4.99	4.93	4.89	4.99	5.03			
Dimensions	Unit	Height	mm		1,800		1,820		1,800		1,820	
		Width	mm		1,195							
		Depth	mm		2,680	3,200		3,800	3,200	3,800		
Weight	Unit	kg		764	880	1,021	1,116	1,050	1,153			
	Operation weight			kg	774	890	1,037	1,132	1,065	1,174		
Water heat exchanger	Type			Braze plate								
	Water flow rate	Cooling	Nom.	l/s	3.6	4.1	4.8	6.0	5.3	6.7		
	Water pressure drop	Cooling	Nom.	kPa	23.3	29.6	18.4	23.0	17.8	18.4		
	Water volume			l	5.58	4.86		5.60		8.10		
Air heat exchanger	Type			Microchannel								
Compressor	Type			Scroll compressor								
	Quantity			2								
Fan	Type			Direct propeller								
	Quantity			6		8		10		8		10
	Air flow rate	Nom.		l/s	6,787	7,356	9,023	11,309	9,023	11,309		
	Speed			rpm	1,108							
Sound power level	Cooling	Nom.		dBA	80	82	84	86				
Sound pressure level	Cooling	Nom.		dBA	62	65	66	67	68	67		
Operation range	Air side	Cooling	Min.-Max.	°CDB	-10~45							
	Water side	Cooling	Min.-Max.	°CDB	-10~15							
Refrigerant	Type / GWP			R-410A / 2,087.5								
	Circuits			Quantity	1							
Refrigerant charge	Per circuit			kg	8.0		10.0		12.0			
				TCO ₂ eq	16.7		20.9		25.1			
Piping connections	Evaporator water inlet/outlet (OD)			2" 1/2								
Unit	Starting current			Max	A	209	260	267	324	314	362	
	Running current	Cooling	Nom.	A	54	58	63	78	71	90		
		Max			A	65	71	78	95	85	109	
Power supply	Phase/Frequency/Voltage			Hz/V	3~/50/400							

Air cooled multi-scroll chiller, high efficiency, standard/low sound

- › Reliable and efficient scroll compressors with high EER values
- › A series of advantages thanks to the use of large-capacity scroll compressors: increased competitiveness, reduced weight, clearances around the unit
- › **Reduced footprint thanks to the V-shaped frame**
- › Large operation range: ambient temperatures up to 52°C and down to -18°C
- › Ideal solution for **a broad range of comfort and process applications**
- › The unit can be equipped with a hydraulic module optimizing installation time, space and cost
- › MicroTech III controller with superior control logic and easy interface

Cooling only				EWAQ-E-XS/XL		180	200	230	260	320	340
Cooling capacity	Nom.		kW	178	200	226	263	315	334		
Power input	Cooling	Nom.	kW	58.0	65.4	73.8	86.2	103	110		
Capacity control	Method			Step							
	Minimum capacity		%	50.0	43.0	50.0	33.0	27.0	33.0		
EER				3.06							
ESEER				4.02	4.11	3.91	4.18	4.17	4.14		
IPLV				4.50	4.68	4.51	4.83	4.76	4.66		
Dimensions	Unit	Height	mm	2,271							
		Width	mm	1,224							
		Depth	mm	4,413				5,313		6,213	
Weight (XS)	Unit		kg	1,722	1,807	1,871	2,173	2,304	2,492		
	Operation weight		kg	1,734	1,819	1,885	2,188	2,318	2,507		
Weight (XL)	Unit		kg	1,876	1,965	2,032	2,370	2,507	2,705		
	Operation weight		kg	1,889	1,978	2,047	2,385	2,522	2,719		
Water heat exchanger	Type			Plate heat exchanger							
	Water volume		l	12				14			
	Water flow rate	Cooling	Nom.	l/s	8.5	9.6	10.8	12.6	15.1	16.0	
	Water pressure drop	Cooling	Nom.	kPa	27	34	35	47	54		
Air heat exchanger	Type			High efficiency fin and tube type with integral subcooler							
Compressor	Type			Scroll compressor							
	Quantity			2				3			
Fan	Type			Direct propeller							
	Quantity			4		5		6			
	Air flow rate	Nom.	l/s	21,845	21,148	26,874	25,884	32,953	32,065		
	Speed		rpm	900							
Sound power level (XS)	Cooling	Nom.	dBA	93	94	96	95	96	97		
Sound power level (XL)	Cooling	Nom.	dBA	91	92	93	92	93	94		
Sound pressure level (XS)	Cooling	Nom.	dBA	75		76			77		
Sound pressure level (XL)	Cooling	Nom.	dBA		73				74		
Operation range	Water side	Cooling	Min.-Max.	°CDB -13~18							
	Air side	Cooling	Min.-Max.	°CDB -18~52							
Refrigerant	Type / GWP			R-410A / 2,087.5							
	Circuits	Quantity		1							
Refrigerant charge	Per circuit		kg	28.0	31.0	34.0	40.0	43.0	53.0		
			TCO ₂ eq	58.5	64.7	71.0	83.5	89.8	110.6		
Piping connections	Evaporator water inlet/outlet (OD)			3"							
Unit	Maximum starting current		A	384	482	500	447	563	577		
	Nominal running current (RLA)	Cooling	A	103	115	129	151	179	190		
	Maximum running current		A	133	147	165	195	227	241		
Power supply	Phase/Frequency/Voltage		Hz/V	3~/50/400							

Air cooled multi-scroll chiller, high efficiency, reduced sound



EWAQ-E-XS/XL/XR

MicroTech III

Cooling only				EWAQ-E-XR	170	190	220	260	300	320
Cooling capacity	Nom.			kW	172	190	219	254	302	310
Power input	Cooling	Nom.		kW	56.5	63.6	71.8	85.4	102	107
Capacity control	Method			Step						
	Minimum capacity			%	50.0	43.0	50.0	33.0	27.0	33.0
EER					3.05	2.98	3.05	2.97	2.96	2.89
ESEER					4.45	4.57	4.33	4.65	4.62	4.50
IPLV					5.09	4.95	4.90	5.04	5.07	5.20
Dimensions	Unit	Height		mm	2,271					
		Width		mm	1,224					
		Depth		mm	4,413		5,313		6,213	
Weight	Unit			kg	1,970	2,064	2,134	2,489	2,632	2,840
	Operation weight			kg	1,982	2,076	2,148	2,503	2,647	2,855
Water heat exchanger	Type			Plate heat exchanger						
	Water volume			l	12		14			
	Water flow rate	Cooling	Nom.	l/s	8.2	9.1	10.5	12.1	14.5	14.8
	Water pressure drop	Cooling	Nom.	kPa	26	39	33	44	43	52
Air heat exchanger	Type			High efficiency fin and tube type with integral subcooler						
Compressor	Type			Scroll compressor						
	Quantity				2		3		3	
Fan	Type			Direct propeller						
	Quantity				4		5		6	
	Air flow rate	Nom.		l/s	16,743	18,405	20,618	20,056	25,243	28,009
	Speed			rpm	705	784	705	705	88	784
Sound power level	Cooling	Nom.		dB(A)	85	86	87	86	88	89
Sound pressure level	Cooling	Nom.		dB(A)	66	67	68	67	68	69
Operation range	Water side	Cooling	Min.-Max.	°CDB	-13~18					
	Air side	Cooling	Min.-Max.	°CDB	-18~52					
Refrigerant	Type / GWP			R-410A / 2,087.5						
	Circuits	Quantity			1					
Refrigerant charge	Per circuit			kg	28.0	31.0	27.0	35.0	43.0	53.0
				TCO ₂ eq	58.5	64.7	56.4	73.1	89.8	110.6
Piping connections	Evaporator water inlet/outlet (OD)			3"						
Unit	Maximum starting current			A	379	482	493	440	554	577
	Nominal running current (RLA)	Cooling		A	101	117	127	151	179	193
	Maximum running current			A	127	147	158	188	219	241
Power supply	Phase/Frequency/Voltage			Hz/V	3~/50/400					

Air cooled multi-scroll chiller, standard efficiency, standard/low sound

- › Reliable and efficient scroll compressors with high EER values
- › A series of advantages thanks to the use of large-capacity scroll compressors: increased competitiveness, reduced weight, clearances around the unit
- › **2 truly independent refrigerant circuits**
- › Reduced footprint thanks to the **V-shaped frame** (EWAQ210-350/400F-SS/SL & EWAQ200-330/370F-SR)
- › Large operation range: ambient temperatures up to 52°C and down to -18°C
- › The unit can be equipped with a hydraulic module optimizing installation time, space and cost
- › Ideal solution for a broad range of comfort and process applications
- › MicroTech III controller with superior control logic and easy interface

Cooling only				EWAQ-F-SS/SL		210	230	250	280	320	350	360	400	410	480	550	610								
Cooling capacity	Nom.	kW		206	224	247	283	313	359			423	407	480	551	609									
Power input	Cooling	Nom. kW		73.3	84.9	93.6	109	122	141			154		187	207	229									
Capacity control	Method			Step																					
	Minimum capacity	%		25.0	22.0	25.0	23.0	25.0	21.0			25.0		17.0	14.0	17.0									
EER				2.81	2.64		2.60	2.58	2.55			2.75	2.64	2.57	2.67	2.66									
ESEER				3.79	3.77	3.81	3.74	3.78	3.73		4.02	3.74	4.04	4.13	4.05	4.08									
IPLV				4.50	4.45	4.50	4.44	4.53	4.29	4.41	4.30	4.46	4.55	4.63	4.72										
Dimensions	Unit	Height	mm	2,271						2,221	2,447	2,397		2,221											
		Width	mm	1,224						2,258	1,224	2,258													
		Depth	mm	4,413			5,313			6,213	3,210	6,213	3,210	4,110	5,010										
Weight (SS)	Unit	kg		2,058	2,130	2,202	2,284	2,409	2,509	2,659	2,759	2,990	3,336	3,558											
	Operation weight	kg		2,070	2,142	2,216	2,298	2,424	2,524	2,699	2,799	3,036	3,382	3,604											
Weight (SL)	Unit	kg		2,297	2,373	2,449	2,535	2,666	2,766	2,968	3,068	3,315	3,679	3,912											
	Operation weight	kg		2,309	2,385	2,463	2,549	2,681	2,781	3,008	3,108	3,362	3,725	3,958											
Water heat exchanger	Type	Plate heat exchanger																							
	Water volume	l		12				14				40				46									
	Water flow rate	Cooling	Nom.	l/s		9.9	10.7	11.8	13.6	15.0	17.2		20.3	19.5	23.0	26.4	29.2								
	Water pressure drop	Cooling	Nom.	kPa		37	43	53	56	69	30		27	32	35	46	56								
Air heat exchanger	Type	High efficiency fin and tube type with integral subcooler																							
Compressor	Type	Scroll compressor																							
	Quantity	4												6											
Fan	Type	Direct propeller																							
	Quantity	4				5				6				8				10							
	Air flow rate	Nom.		l/s		21,845		21,148		27,306		26,435		32,767		36,265		32,513		43,690		54,612		52,870	
	Speed	rpm		900								980				900									
Sound power level (SS)	Cooling	Nom.		dBA		93	94	95				97				99									
Sound power level (SL)	Cooling	Nom.		dBA		91	92				93				94				95						
Sound pressure level (SS)	Cooling	Nom.		dBA		75				76				77	78				79						
Sound pressure level (SL)	Cooling	Nom.		dBA		73				74	75	74	75				76								
Operation range	Water side	Cooling	Min.-Max.		°CDB		-13~18																		
	Air side	Cooling	Min.-Max.		°CDB		-18~52																		
Refrigerant	Type / GWP	R-410A / 2,087.5																							
	Circuits	Quantity		2																					
Refrigerant charge	Per circuit		kg		14.0	15.5	16.5	20.0	23.0			27.0		28.0	32.5	40.0									
			TCO ₂ eq		29.2	32.4	34.4	41.8	48.0			56.4		58.5	67.8	83.5									
Piping connections	Evaporator water inlet/outlet (OD)		3"																						
Unit	Maximum starting current		A		349	404	419	476	505	621			649		634	768	810								
	Nominal running current (RLA)		Cooling A		130	147	161	187	208	242			259	262	322	356	391								
	Maximum running current		A		160	176	191	225	254	286			314		383	433	474								
Power supply	Phase/Frequency/Voltage		Hz/V		3~/50/400																				

Air cooled multi-scroll chiller, standard efficiency, reduced sound



EWAQ-F-SS/SL/SR

MicroTech III

Cooling only				EWAQ-F-SR												
		Nom.		200	220	240	270	300	330	340	370	380	460	530	580	
Cooling capacity	Nom.	kW		198	214	235	270	298	341		383		456	527	580	
Power input	Cooling	kW		73.4	86.0	95.6	110	125	144		159		191	208	233	
Capacity control	Method	Step														
	Minimum capacity	%		25.0	22.0	25.0	23.0	25.0	21.0		25.0		17.0	14.0	17.0	
EER			2.70		2.49	2.46	2.45	2.38	2.37		2.41		2.39	2.53	2.49	
ESEER			4.27		4.20	4.13	4.16	4.08	4.10	4.27	4.03	4.16	4.53	4.49	4.43	
IPLV			4.96		4.89	4.82	4.92	4.85	4.71	4.86	4.61	4.73	5.09	5.00	4.93	
Dimensions	Unit	Height	mm	2,271					2,221		2,447	2,397	2,221			
		Width	mm	1,224					2,258		1,224	2,258				
		Depth	mm	4,413			5,313		6,213	3,210	6,213	3,210	4,110	5,010		
Weight	Unit	kg		2,412		2,491	2,571	2,661	2,799	2,899	3,116	3,216	3,481	3,863	4,108	
	Operation weight	kg		2,424		2,504	2,585	2,676	2,814	2,914	3,156	3,256	3,527	3,909	4,154	
Water heat exchanger	Type	Plate heat exchanger														
	Water volume	l		12					14		40		46			
	Water flow rate	Cooling	Nom.	l/s	9.5	10.2	11.3	13.0	14.3	16.3		18.3		21.8	25.2	27.8
	Water pressure drop	Cooling	Nom.	kPa	34	40	48	51	63	27		29		31	42	51
Air heat exchanger	Type	High efficiency fin and tube type with integral subcooler														
Compressor	Type	Scroll compressor														
	Quantity	4										6				
Fan	Type	Direct propeller														
	Quantity	4			5		6			8		10				
	Air flow rate	Nom.	l/s	16,743		16,285	20,929	20,356	25,115		24,922		33,487	41,858	40,713	
	Speed	rpm		705												
Sound power level	Cooling	Nom.	dBA	85	86	87		89		90		89	91	92		
Sound pressure level	Cooling	Nom.	dBA	66	67	68		69	70		71	70	71	72		
Operation range	Water side	Cooling	Min.-Max.	°CDB -13~18												
	Air side	Cooling	Min.-Max.	°CDB -18~52												
Refrigerant	Type / GWP	R-410A / 2,087.5														
	Circuits	Quantity		2												
Refrigerant charge	Per circuit	kg		16.0	18.0	19.0	20.0	23.0		27.0		28.0	32.5	40.0		
		TCO ₂ eq		33.4	37.6	39.7	41.8	48.0		56.4		58.5	67.8	83.5		
Piping connections	Evaporator water inlet/outlet (OD)			3"												
Unit	Maximum starting current		A	344	398	414	469	498	613		641		623	754	796	
	Nominal running current (RLA)	Cooling	A	129	149	164	189	214	247		270		328	359	398	
	Maximum running current	A		155	170	186	218	247	277		305		372	419	460	
Power supply	Phase/Frequency/Voltage			Hz/V 3~/50/400												

Air cooled multi-scroll chiller, high efficiency, standard/low sound

- › Reliable and efficient scroll compressors with **high EER values**
- › A series of advantages thanks to the use of large-capacity scroll compressors: increased competitiveness, reduced weight, clearances around the unit
- › **2 truly independent refrigerant circuits**
- › Reduced footprint thanks to the **V-shaped frame** (EWAQ170-310/350F-XS/XL & EWAQ170-300/330F-XR)
- › Large operation range: ambient temperatures up to 52°C and down to -18°C
- › The unit can be equipped with a hydraulic module optimizing installation time, space and cost
- › Ideal solution for a broad range of comfort and process applications
- › MicroTech III controller with superior control logic and easy interface

Cooling only				EWAQ-F-XS/XL																							
Cooling capacity		Nom.		kW		170	200	220	250	310	320	350	360	400	430	450	520	610	680								
Power input	Cooling	Nom.		kW		54.8	62.2	70.6	78.3	102		115		130	137	146	170	198	219								
Capacity control	Method			Step																							
	Minimum capacity			%		25.0	21.0	25.0	22.0	23.0		25.0		21.0	20.0	25.0	17.0	14.0	17.0								
EER					3.11	3.13	3.12		3.09				3.10	3.12		3.10	3.07										
ESEER					3.90	4.10	3.95	4.08	4.04	4.30	4.05	4.33	4.24	4.27	4.23	4.35	4.30	4.23									
IPLV					4.56	4.76	4.67	4.70	4.67	4.60	4.64	4.80	4.72	4.65	4.61	4.95	4.82	4.68									
Dimensions	Unit	Height		mm		2,271				2,221	2,271	2,221															
		Width		mm		1,224				2,258	1,224	2,258															
		Depth		mm		4,413	5,313		6,213	3,210	6,213	3,210	4,110		5,010	5,910											
Weight (XS)	Unit			kg		1,688	1,958	2,210	2,339	2,500	2,600	2,632	2,732	2,744	2,845	2,861	3,569	3,667	4,054								
	Operation weight		kg		1,700	1,973	2,225	2,353	2,514		2,672	2,772	2,784	2,891	2,907	3,615	3,727	4,115									
Weight (XL)	Unit			kg		1,909	2,193	2,457	2,592	2,761	2,861	2,900	3,000	3,017	3,124	3,141	3,923	4,026	4,434								
	Operation weight		kg		1,921	2,207	2,472	2,607	2,776	2,876	2,940	3,040	3,057	3,170	3,187	3,970	4,087	4,494									
Water heat exchanger	Type			Plate heat exchanger																							
	Water volume		l		12	14				40				46				60									
	Water flow rate	Cooling	Nom.	l/s		8.2	9.3	10.5	11.7	15.1		17.0		19.3	20.5	21.8	25.3	29.0	32.2								
	Water pressure drop	Cooling	Nom.	kPa		25	27	34	42	22		23		31	29	30	41	44	55								
Air heat exchanger	Type			High efficiency fin and tube type with integral subcooler																							
Compressor	Type			Scroll compressor																							
	Quantity			4												6											
Fan	Type			Direct propeller																							
	Quantity			4				5				6				8				10				12			
	Air flow rate	Nom.		l/s		21,845	21,148	26,874	25,204	31,722		30,245		42,296	40,326		50,408		60,489								
	Speed			rpm		900																					
Sound power level (XS)	Cooling	Nom.		dBA		91	93	94	95	96				97	98				99	100							
Sound power level (XL)	Cooling	Nom.		dBA		90	91	92				93				95				96	97						
Sound pressure level (XS)	Cooling	Nom.		dBA		72	74	75	76	77	76	77	78		79	78	79										
Sound pressure level (XL)	Cooling	Nom.		dBA		71	73				74				75				76								
Operation range	Water side	Cooling	Min.-Max.		°CDB		-13~18																				
	Air side	Cooling	Min.-Max.		°CDB		-18~52																				
Refrigerant	Type / GWP			R-410A / 2,087.5																							
	Circuits			Quantity		2																					
Refrigerant charge	Per circuit			kg		14.0	15.5	16.5	20.0	26.0				31.0				37.0	36.0	41.5							
				TCO ₂ eq		29.2	32.4	34.4	41.8	54.3				64.7				77.2	75.2	86.6							
Piping connections	Evaporator water inlet/outlet (OD)			3"																							
Unit	Maximum starting current			A		281	338	353	408	480				509	629	643	657	642	768	818							
	Nominal running current (RLA)		Cooling	A		110	117	128	141	181		202	229	240	254	300	343	379									
	Maximum running current			A		138	149	164	180	229		258	294	308	322	391	433	482									
Power supply	Phase/Frequency/Voltage			Hz/V		3~/50/400																					

Air cooled multi-scroll chiller, high efficiency, reduced sound



EWAQ-F-XS/XL/XR

MicroTech III

Cooling only				EWAQ-F-XR																																								
		Nom.		170	190	210	240	300	310	330	340	390	410	430	500	580	650																											
Cooling capacity	Nom.	kW		165	188	211	236	304		340		385	407	433	502	579	645																											
Power input	Cooling	Nom.		kW		53.0	61.2	68.7	77.3	101		117	128	136	146	170	200	219																										
Capacity control	Method	Step																																										
	Minimum capacity	%		25.0	21.0	25.0	22.0	23.0		25.0		21.0	20.0	25.0	17.0	14.0	17.0																											
EER					3.12	3.07	3.08	3.05	3.00		2.92		3.01	2.99	2.96		2.90	2.95																										
ESEER					4.53	4.64	4.51	4.60	4.53	4.68	4.44	4.63	4.68	4.64	4.54	4.82	4.69	4.65																										
IPLV					5.25	5.04	5.19	5.27	5.04	5.16	5.01	4.89	5.04	4.90	4.99	5.13	5.15	5.18																										
Dimensions	Unit	Height	mm		2,271				2,221		2,271		2,221																															
		Width	mm		1,224				2,258		1,224		2,258																															
		Depth	mm		4,413		5,313		6,213		3,210		6,213		3,210		4,110		5,010		5,910																							
Weight	Unit	kg		2,004	2,303	2,580	2,722	2,900	3,000	3,045	3,145	3,168	3,280	3,298	4,120	4,228	4,655																											
	Operation weight	kg		2,017	2,317	2,594	2,736	2,914	3,014	3,085	3,185	3,208	3,326	3,344	4,166	4,288	4,716																											
Water heat exchanger	Type	Plate heat exchanger																																										
	Water volume	l		12				14				40				46				60																								
	Water flow rate	Cooling	Nom.	l/s		7.9	9.0	10.1	11.3	14.5		16.3		18.4	19.5	20.7	24.0	27.7	30.9																									
Air heat exchanger	Type	High efficiency fin and tube type with integral subcooler																																										
		Compressor																																										
Compressor	Type	Scroll compressor																																										
	Quantity	4												6																														
Fan	Type	Direct propeller																																										
	Quantity	4				5				6				8				10				12																						
	Air flow rate	Nom.		l/s		16,743	16,285	20,618	19,522	24,428		23,426		32,570	31,235		39,044		46,852																									
Sound power level	Cooling	Nom.	dB(A)		83				84				85				86				87				89				90				89				90				92			
			dB(A)		64		65		66		67		68		67		68		69		70		69		70		71																	
Operation range	Water side	Cooling	Min.-Max.	°CDB		-13~18																																						
				Air side	Cooling	Min.-Max.	°CDB		-18~52																																			
Refrigerant	Type / GWP	R-410A / 2,087.5																																										
	Circuits	Quantity	2																																									
Refrigerant charge	Per circuit	kg		14.0	15.5	16.5	20.0	24.0	26.0		31.0		35.0		36.0		41.5																											
		TCO ₂ eq		29.2	32.4	34.4	41.8	50.1	54.3		64.7		73.1		75.2		86.6																											
Piping connections	Evaporator water inlet/outlet (OD)		3"																																									
Unit	Maximum starting current	A		276	332	346	401	472		501		618	632	646	628	754	801																											
	Nominal running current (RLA)	Cooling	A		107	116	125	139	180		204		226	239	255	300	347	380																										
	Maximum running current	A		132	143	157	173	220		249		283	296	310	377	419	465																											
Power supply	Phase/Frequency/Voltage		Hz/V		3~/50/400																																							

Air cooled multi-scroll inverter chiller, high efficiency, standard sound

- › High efficiency **DC inverter scroll** compressors
- › Advanced compressor and fan design resulting in low operating sound levels
- › Dual independent refrigerant circuit for built-in redundancy and reliable operation
- › Wide operating range in cooling mode
- › Reduced footprint thanks to the **V-shaped frame** (EWAQ210GZXS & EWAQ190GZXR)
- › MicroTech III controller with superior control logic and easy interface

Cooling only				EWAQ-GZXS	210	270	320	340	400	
Cooling capacity	Nom.			kW	201	270	323	340	395	
Power input	Cooling	Nom.			kW	72.5	94.0	122	144	
Capacity control	Method			Stepless						
	Minimum capacity			%	14.4	14.3	14.9	14.3	14.8	
EER					2.77	2.87	2.64	2.92	2.75	
ESEER					4.79	4.89	4.90	4.77	4.78	
IPLV					5.11	5.26	5.40	5.21	5.23	
Dimensions	Unit	Height			mm	2,270	2,223			
		Width			mm	1,290	2,234			
		Depth			mm	4,450	3,560	4,460		
Weight	Unit			kg	1,600	2,100	2,150	2,400	2,500	
	Operation weight			kg	1,677	2,233	2,297	2,575	2,688	
Water heat exchanger	Type			Plate heat exchanger						
	Water volume			l	29	61	75	79	92	
	Water flow rate	Cooling	Nom.	l/s	9.6	12.9	15.4	16.3	18.9	
	Water pressure drop	Cooling	Total	kPa	27	14	15	16	18	
Air heat exchanger	Type			High efficiency fin and tube type with integral subcooler						
Compressor	Type			DC Inverter Scroll						
	Quantity				6	8	10	12		
Fan	Type			Direct propeller						
	Quantity				4	6	8			
	Air flow rate	Cooling	Nom.	l/s	17,473	26,209		34,946		
	Speed			rpm	920					
Sound power level	Cooling	Nom.			dB(A)	92	94	96		
Sound pressure level	Cooling	Nom.			dB(A)	75	78		79	
Operation range	Water side	Cooling	Min.~Max.	°CDB	-8~20					
	Air side	Cooling	Min.~Max.	°CDB	-18~43					
Refrigerant	Type / GWP			R-410A / 2,087.5						
	Circuits	Quantity			1	2				
Refrigerant charge	Per circuit			kg	48.0	36.0		48.0		
				TCO ₂ eq	100.2	75.2		100.2		
Piping connections	Evaporator water inlet/outlet (OD)				2.5"	4.5"				
Unit	Maximum starting current				A	2				
	Nominal running current (RLA)	Cooling			A	114	155	195	189	227
	Maximum running current				A	155	236	281	286	309
Power supply	Phase/Frequency/Voltage				Hz/V	3~/50/400				

Air cooled multi-scroll inverter chiller, high efficiency, reduced sound



Cooling only				EWAQ-GZXR	190	270	320	340	390
Cooling capacity	Nom.			kW	196	264	315	334	386
Power input	Cooling	Nom.		kW	73.3	94.8	124	117	145
Capacity control	Method			Stepless					
	Minimum capacity			%	14.4	14.3	14.9	14.3	14.8
EER					2.68	2.79	2.53	2.86	2.65
ESEER					4.88	4.95	5.05	5.07	
IPLV					5.16	5.25		5.27	5.24
Dimensions	Unit	Height	mm		2,270	2,223			
		Width	mm		1,290	2,234		2,241	
		Depth	mm		4,450	3,560		4,460	
Weight	Unit			kg	1,618	2,124	2,180	2,430	2,536
	Operation weight				kg	1,695	2,257	2,327	2,605
Water heat exchanger	Type			Plate heat exchanger					
	Water volume			l	29	61	75	79	92
	Water flow rate	Cooling	Nom.	l/s	9.4	12.6	15.0	16.0	18.5
	Water pressure drop	Cooling	Total	kPa	26	14	15		17
Air heat exchanger	Type			High efficiency fin and tube type with integral subcooler					
Compressor	Type			DC Inverter Scroll					
	Quantity				6	8	10		12
Fan	Type			Direct propeller					
	Quantity				4	6		8	
	Air flow rate	Nom.		l/s	15,131	22,697		30,263	
	Speed			rpm	715				
Sound power level	Cooling	Nom.		dB(A)	89	91		92	
Sound pressure level	Cooling	Nom.		dB(A)	72	74		75	
Operation range	Water side	Cooling	Min.-Max.	°CDB	-8~20				
	Air side	Cooling	Min.-Max.	°CDB	-18~43				
Refrigerant	Type / GWP			R-410A / 2,087.5					
	Circuits	Quantity			1	2			
Refrigerant charge	Per circuit			kg	48.0	36.0		48.0	
				TCO _{Eq}	100.2	75.2		100.2	
Piping connections	Evaporator water inlet/outlet (OD)				2.5"	4.5"			
Unit	Maximum starting current			A	2				
	Nominal running current (RLA) Cooling			A	116	157	199	190	231
	Maximum running current			A	153	234	279	283	306
Power supply	Phase/Frequency/Voltage			Hz/V	3~/50/400				

Air cooled screw chiller, standard efficiency, standard sound

- › One refrigerant circuit with single screw compressor
- › **Compact design** with brazed plate heat exchanger
- › Large operation range (ambient temperature down to -18°C)
- › Water supply down to -15°C

Cooling only				EWAD-E-SS																													
				100	120	140	160	180	210	260	310	360	410																				
Cooling capacity	Nom.			kW										101	121	138	163	183	213	255	306	359	411										
Power input	Cooling			Nom.										kW										39.1	47.5	53.9	60.9	69.0	72.4	87.8	112	134	147
Capacity control	Method			Stepless																													
	Minimum capacity			%																		25.0											
EER														2.58	2.54	2.55	2.67	2.64	2.95	2.90	2.73	2.67	2.80										
ESEER														2.84	2.83	2.66	2.84	2.73	2.93	3.08	2.96	3.13	3.24										
IPLV														3.36	3.25	2.98	3.13	3.25	3.48	3.68	3.56	3.61	3.65										
Dimensions	Unit	Height		mm										2,273						2,223													
		Width		mm										1,292						2,236													
		Depth		mm										2,165				3,065				3,965				3,070							
Weight	Unit			kg										1,684				1,861				2,086				2,919							
		Operation weight		kg										1,699				1,881				2,116				2,963							
Water heat exchanger	Type			Plate heat exchanger																													
	Water volume		l										12	15	17	20	24	30	25	30	36	44											
	Water flow rate	Cooling	Nom.	l/s										4.8	5.8	6.6	7.8	8.7	10.2	12.2	14.6	17.2	19.7										
	Water pressure drop	Cooling	Nom.	kPa										24	25	23	24	22	21	47	48	45											
Air heat exchanger	Type			High efficiency fin and tube type with integral subcooler																													
Compressor	Type			Single screw compressor										Asymmetric single screw compressor																			
	Quantity			1																													
Fan	Type			Direct propeller																													
	Quantity			2				3				4				6																	
	Air flow rate	Nom.		l/s										10,924	10,576	16,386	15,865	21,848	21,153	32,772	31,729												
	Speed			rpm																		900											
Sound power level	Cooling	Nom.		dBA										92				93				94				95							
Sound pressure level	Cooling	Nom.		dBA										74				75				76											
Operation range	Water side	Cooling	Min.-Max.	°CDB										-15~-15																			
	Air side	Cooling	Min.-Max.	°CDB										-18~-48																			
Refrigerant	Type / GWP			R-134a / 1,430																													
	Circuits			Quantity																		1											
Refrigerant charge	Per circuit			kg										18.0	21.0	23.0	28.0	34.0	39.0	46.0	56.0	74.0											
				TCO ₂ eq										25.7	30.0	32.9	40.0	48.6	55.8	65.8	80.1	105.8											
Piping connections	Evaporator water inlet/outlet (OD)			3"																													
Unit	Maximum starting current			A										151				195				288				330				410			
	Nominal running current (RLA)	Cooling		A										67	81	92	102	116	121	148	185	220	241										
	Maximum running current			A										86	103	119	132	157	164	198	242	284	298										
Power supply	Phase/Frequency/Voltage			Hz/V																		3~/50/400											

Air cooled screw chiller, standard efficiency, low sound



EWAD-E-SS/SL

MicroTech III

Cooling only				EWAD-E-SL	100	120	130	160	180	210	250	300	350	400						
Cooling capacity	Nom.		kW	97.6	116	134	157	177	208	248	295	344	397							
Power input	Cooling	Nom.		kW	39.2	48.3	53.4	60.8	68.3	72.8	85.4	111	135	152						
Capacity control	Method			Stepless																
	Minimum capacity			%	25.0															
EER					2.49	2.39	2.50	2.57	2.59	2.86	2.90	2.65	2.55	2.62						
ESEER					2.92	2.88	2.76	2.91	2.98	3.22	3.44	3.31	3.24	3.35						
IPLV					3.32	3.21	3.30	3.46	3.28	3.48	3.86	3.75	3.63	3.76						
Dimensions	Unit	Height		mm	2,273						2,223									
		Width		mm	1,292						2,236									
		Depth		mm	2,165		3,065		3,965		3,070									
Weight	Unit			kg	1,784		1,961		2,186		3,029									
		Operation weight		kg	1,799		1,981		2,216		3,073									
Water heat exchanger	Type			Plate heat exchanger																
	Water volume		l	12	15	17	20	24	30	25	30	36	44							
	Water flow rate	Cooling	Nom.	l/s	4.7	5.5	6.4	7.5	8.4	10.0	11.9	14.1	16.5	19.0						
Air heat exchanger	Type	Cooling		Nom.	23		22		23		21		20		45		44		42	
		High efficiency fin and tube type with integral subcooler																		
Compressor	Type			Single screw compressor											Asymmetric single screw compressor					
	Quantity			1											1					
Fan	Type			Direct propeller																
	Quantity			2		3		4		6										
	Air flow rate	Nom.		l/s	8,373	8,144	12,560	12,216	16,747	16,288	25,120		24,432							
Sound power level	Cooling	Nom.		dB(A)	89		90		92						93					
		Nom.		dB(A)	71		73						74							
Operation range	Water side	Cooling	Min.-Max.	°CDB	-15~-15															
	Air side	Cooling	Min.-Max.	°CDB	-18~-48															
Refrigerant	Type / GWP			R-134a / 1,430																
	Circuits		Quantity	1																
Refrigerant charge	Per circuit			kg	18.0	21.0	23.0	28.0	34.0	39.0	46.0	56.0	74.0							
				TCO ₂ eq	25.7	30.0	32.9	40.0	48.6	55.8	65.8	80.1	105.8							
Piping connections	Evaporator water inlet/outlet (OD)			3"																
Unit	Maximum starting current			A	151		195		288		330	410								
	Nominal running current (RLA)		Cooling	A	67	83	92	103	116	122	144	184	223	249						
	Maximum running current			A	83	100	115	128	151	158	189	234	276	290						
Power supply	Phase/Frequency/Voltage			Hz/V	3~/50/400															

Air cooled screw chiller, standard efficiency, standard sound

- › 2 truly independent refrigerant circuits
- › Stepless single-screw compressor
- › Optimised for use with R-134a
- › Large operation range (ambient temperature down to -18°C)
- › MicroTech III controller with superior control logic and easy interface

Cooling only				EWAD-D-SS	390	440	470	510	530	560	580
Cooling capacity	Nom.			kW	388	435	463	500	529	553	575
Power input	Cooling	Nom.		kW	154	165	169	186	196	207	199
Capacity control	Method				Stepless						
	Minimum capacity			%	12.5						
EER					2.52	2.63	2.74	2.70		2.67	2.89
ESEER					3.26	3.43	3.44	3.41		3.45	3.29
IPLV					3.75	3.86	3.89	3.96		4.11	3.96
Dimensions	Unit	Height		mm	2,223						
		Width		mm	2,234						
		Depth		mm	3,139	4,030		4,220	4,040		4,230
Weight	Unit			kg	2,960	4,030	4,220	4,230		4,235	
	Operation weight			kg	3,090	4,195	4,395				
Water heat exchanger	Type				Single pass shell & tube						
	Water volume			l	130	165	175	165		160	
	Water flow rate	Cooling	Nom.	l/s	18.6	20.8	22.2	24.0	25.4	26.5	27.6
	Water pressure drop	Cooling	Nom.	kPa	46	38	67	47	52	57	51
Air heat exchanger	Type				High efficiency fin and tube type with integral subcooler						
Compressor	Type				Single screw compressor	Asymmetric single screw compressor					
	Quantity				2						
Fan	Type				Direct propeller						
	Quantity				6		8				
	Air flow rate	Nom.		l/s	32,772	31,729	43,696			42,306	
	Speed			rpm	890						
Sound power level	Cooling	Nom.		dBA	96	97		98	99		
Sound pressure level	Cooling	Nom.		dBA	77			79			
Operation range	Water side	Cooling	Min.-Max.	°CDB	-15~-15						
	Air side	Cooling	Min.-Max.	°CDB	-18~-48						
Refrigerant	Type / GWP				R-134a / 1,430						
	Circuits	Quantity			2						
Refrigerant charge	Per circuit			kg	28.0	33.0	36.0	38.0	40.0	43.0	47.0
				TCO ₂ eq	40.0	47.2	51.5	54.3	57.2	61.5	67.2
Piping connections	Evaporator water inlet/outlet (OD)				5.5"						
Unit	Maximum starting current			A	419	464	485		494		
	Nominal running current (RLA)	Cooling		A	254	274	281	306	321	336	324
	Maximum running current			A	312	330	359	380	391	402	
Power supply	Phase/Frequency/Voltage			Hz/V	3~/50/400						

Air cooled screw chiller, standard efficiency, low sound



Cooling only				EWAD-D-SL														
Cooling capacity		Nom.		180	200	230	250	260	280	300	320	370	400	440	480	510	530	
Power input		Cooling		Nom.		kW												
Capacity control		Method		Stepless														
		Minimum capacity		%														
EER		2.24 2.46 2.62 2.58 2.54 2.50 2.46 2.56 2.72 2.36 2.55 2.53 2.46 2.70																
ESEER		2.91 3.03 3.21 3.11 3.16 3.13 3.10 3.14 3.31 3.54 3.56 3.46 3.56 3.66																
IPLV		3.43 3.56 3.73 3.63 3.66 3.63 3.59 3.62 3.84 3.85 4.06 3.96 4.07 4.14																
Dimensions	Unit	Height		mm														
		Width		mm														
		Depth		mm														
Weight	Unit	kg		2,239 3,139 4,040														
		Operation weight		kg 2,475 2,470 2,860 3,187 4,030 4,220 4,230 4,235														
Water heat exchanger	Type		Plate heat exchanger Single pass shell & tube															
	Water volume		l 25 30 100 130 165 170 165 160															
	Water flow rate		Cooling		Nom.		l/s 8.8 9.4 10.7 11.7 12.5 13.1 14.2 15.3 17.7 19.3 21.0 22.8 24.1 25.4											
	Water pressure drop		Cooling		Nom.		kPa 29 22 58 49 54 59 60 55 67 48 62 54 48 43											
Air heat exchanger		Type		High efficiency fin and tube type with integral subcooler														
Compressor	Type		Single screw compressor Asymmetric single screw compressor															
	Quantity		2															
Fan	Type		Direct propeller															
	Quantity		4 6 8 6 8															
	Air flow rate		Nom.		l/s 15,295 14,868 22,943 22,623 22,302 30,591 24,432 33,493 32,576													
		Speed		rpm 900 705														
Sound power level		Cooling		Nom.		dBA 94 95 97 94 96												
Sound pressure level		Cooling		Nom.		dBA 75 78 75 76 77												
Operation range	Water side		Cooling		Min.-Max.		°CDB -15~-15											
	Air side		Cooling		Min.-Max.		°CDB -18~-48											
Refrigerant	Type / GWP		R-134a / 1,430															
	Circuits		Quantity		2													
Refrigerant charge	Per circuit		kg		18.0 21.0 23.0 26.0 28.0 29.0 35.0 36.0 34.0 40.0 43.0													
			TCO ₂ eq		25.7 30.0 32.9 37.2 40.0 41.5 50.1 51.5 48.6 57.2 61.5													
Piping connections		Evaporator water inlet/outlet (OD)		3" 4" 5"														
Unit	Maximum starting current		A 218 234 277 286 298 300 305 460 480 488															
	Nominal running current (RLA)		Cooling		A 135 133 141 155 166 176 192 200 214 281 285 308 334 323													
	Maximum running current		A 165 186 202 213 224 238 258 269 322 348 368 379															
Power supply		Phase/Frequency/Voltage		Hz/V 3~/50/400														

Air cooled screw chiller, standard efficiency, reduced sound

- › 2 truly independent refrigerant circuits
- › Stepless single-screw compressor
- › Optimised for use with R-134a
- › Large operation range (ambient temperature down to -18°C)
- › MicroTech III controller with superior control logic and easy interface

Cooling only				EWAD-D-SR												180	190	220	240	250	270	280	310	370	400	440	480	510	530												
Cooling capacity	Nom.			kW			177	190	218	237	251	263	277	310	364	402	438	475	503	531																					
Power input	Cooling	Nom.		kW			84.5	83.1	86.2	95.6	104	112	123	127	140	171	172	188	205	197																					
Capacity control	Method			Stepless																																					
	Minimum capacity			%			12.5																																		
EER				2.09	2.28	2.53	2.48	2.41	2.34	2.25	2.45	2.60	2.36	2.55	2.53	2.46	2.70																								
ESEER				2.80	2.91	3.24	3.11	3.13	3.07	3.04	3.15	3.32	3.54	3.56	3.46	3.56	3.66																								
IPLV				3.29	3.42	3.74	3.59		3.56	3.53	3.70	3.88	3.90	4.06	3.96	4.07	4.14																								
Dimensions	Unit	Height		mm			2,355												2,234																						
		Width		mm			2,234												4,040																						
		Depth		mm			2,239			3,139			3,335			4,040																									
Weight	Unit	Operation weight		kg			2,650			3,100			3,450			4,342																									
		Weight		kg			2,620			2,890			3,335			4,240																									
Water heat exchanger	Type			Plate heat exchanger			Single pass shell & tube																																		
	Water volume		l			25	30	100			130			165			170																								
	Water flow rate	Cooling	Nom.	l/s			8.5	9.1	10.4	11.3	12.0	12.6	13.3	14.9	17.4	19.3	21.0	22.8	24.1	25.4																					
Air heat exchanger	Type			High efficiency fin and tube type with integral subcooler																																					
	Compressor			Single screw compressor												Asymmetric single screw compressor																									
Fan	Type			Direct propeller																																					
	Quantity			4			6			8			6			8																									
	Air flow rate	Nom.		l/s			12,389	11,928	18,583		18,237		17,892		24,777		24,432		33,493		32,576																				
Sound power level	Cooling		Nom.		dB(A)			89			90			92			91			92																					
	Sound pressure level		Nom.		dB(A)			70			73			71			73																								
Operation range	Water side		Cooling		Min.-Max.		°CDB																																		
	Air side		Cooling		Min.-Max.		°CDB																																		
Refrigerant	Type / GWP			R-134a / 1,430																																					
	Circuits			Quantity																																					
Refrigerant charge	Per circuit			kg			18.0	21.0	24.0	25.0			29.0			33.0			35.0			40.0			39.0			40.0			43.0										
	TCO ₂ eq			kg			25.7	30.0	34.3			35.8			41.5			47.2			50.1			57.2			55.8			57.2			61.5								
Piping connections	Evaporator water inlet/outlet (OD)			3"			4"			5"																															
	Unit	Maximum starting current			A			217			232			275			284			295			297			302			460			480			488						
		Nominal running current (RLA)		Cooling		A			140	138	143	157	169	181	199	203	219	281	285	308	334	323																			
Maximum running current			A			162			182			198			209			219			234			252			263			322			348			368			379		
Power supply	Phase/Frequency/Voltage			Hz/V			3~/50/400																																		

Air cooled screw chiller. standard efficiency. extra low sound



EWAD-D-SR/SX

MicroTech III

Cooling only				EWAD-D-SX										210	230	250	270	290	300	310	370	410	450	490
Cooling capacity	Nom.			kW			202	230	252	270	285	298	308	369	412	449	490							
Power input	Cooling			Nom.			kW			80.8	86.0	94.4	105	115	127	137	150	171	175	189				
Capacity control	Method			Stepless																				
	Minimum capacity			%			12.5																	
EER							2.50	2.68	2.67	2.56	2.47	2.35	2.25	2.46	2.41	2.56	2.60							
ESEER							3.29	3.52	3.41	3.44	3.34	3.29	3.15	3.14	3.39	3.50	3.47							
IPLV							3.82	4.08	3.99	4.01	3.92	3.84	3.69	4.03	3.90	3.98	3.90							
Dimensions	Unit	Height		mm			2.420																	
		Width		mm			2.234																	
		Depth		mm			3.139	4.040										4.940						
Weight	Unit	kg		3.110	3.475			3.425	3.430			3.560	4.302	4.506	4.581									
		Operation weight		kg			3.200	3.590						3.735	4.472	4.676	4.746							
Water heat exchanger	Type			Single pass shell & tube																				
	Water volume			l			90	115			165	160			175	170			165					
	Water flow rate		Cooling			Nom.			l/s			9.7	11.0	12.1	12.9	13.7	14.3	14.7	17.7	19.7	21.5	23.5		
	Water pressure drop		Cooling			Nom.			kPa			45	34	38			35	38	41	45	44	50	45	
Air heat exchanger	Type			High efficiency fin and tube type with integral subcooler																				
Compressor	Type			Single screw compressor															Asymmetric single screw compressor					
	Quantity			2																				
Fan	Type			Direct propeller																				
	Quantity			6	8										9	10								
	Air flow rate		Nom.			l/s			12.876	17.892	17.169			26.496			28.982	33.120						
	Speed			rpm			500																	
Sound power level	Cooling		Nom.			dBA			84	85										86				
Sound pressure level	Cooling		Nom.			dBA			65										66					
Operation range	Water side		Cooling			Min.-Max.			°CDB															
	Air side		Cooling			Min.-Max.			°CDB															
Refrigerant	Type / GWP			R-134a / 1,430																				
	Circuits		Quantity			2																		
Refrigerant charge	Per circuit			kg			21.0	24.0	26.0	32.0	33.0	34.0			35.0	38.0	40.0							
	TCO ₂ eq			kg			30.0	34.3	37.2	45.8	47.2	48.6			50.1	54.3	57.2							
Piping connections	Evaporator water inlet/outlet (OD)			4"										5"										
Unit	Maximum starting current			A			218	232			276	284	296			406	457	475						
	Nominal running current (RLA)		Cooling			A			135	143	157	173	188	204	220	231	272	280	298					
	Maximum running current			A			164	183	199	210	221	235	250	291	316	338	360							
Power supply	Phase/Frequency/Voltage			Hz/V			3~/50/400																	

Air cooled screw chiller, high efficiency, standard sound

- › 2 truly independent refrigerant circuits
- › Stepless single-screw compressor
- › Optimised for use with R-134a
- › Large operation range (ambient temperature down to -18°C)
- › MicroTech III controller with superior control logic and easy interface

Cooling only		EWAD-D-XS		250	280	300	330	350	380	400	470	520	580	620	
Cooling capacity	Nom.	kW		246	274	300	326	350	374	399	467	522	573	620	
Power input	Cooling	Nom. kW		80.1	88.2	95.4	105	114	121	129	152	169	183	196	
Capacity control	Method	Stepless													
	Minimum capacity	%		12.5											
EER				3.07	3.11	3.15	3.10	3.06	3.08	3.10	3.07	3.09	3.12	3.16	
ESEER				3.45	3.49	3.51	3.73	3.56	3.47	3.48	3.72	3.88	3.89	3.75	
IPLV				3.98	4.00		4.08	4.07	4.06	3.98	4.16	4.83		4.61	
Dimensions	Unit	Height	mm	2,355								2,223			
		Width	mm	2,234											
		Depth	mm	3,138	4,040						4,940				
Weight	Unit		kg	2,905	3,285		3,235	3,240			3,510	4,670	4,685		
		Operation weight	kg	3,000	3,400						3,780	4,940			
Water heat exchanger	Type	Single pass shell & tube													
	Water volume	l		95	115			165	160			270	255		
	Water flow rate	Cooling	Nom.	l/s	11.8	13.1	14.4	15.6	16.7	17.9	19.1	22.4	25.0	27.4	29.7
	Water pressure drop	Cooling	Nom.	kPa	48	45	49	46	51	58	64	47	63	56	38
Air heat exchanger	Type	High efficiency fin and tube type with integral subcooler													
Compressor	Type	Single screw compressor											Asymmetric single screw compressor		
	Quantity	2													
Fan	Type	Direct propeller													
	Quantity	6			8						10				
	Air flow rate	Nom.		l/s	22,302	30,591	29,736			43,001	42,306	43,696	54,620		
	Speed			rpm	900						890				
Sound power level	Cooling	Nom.		dBA	97						99				
Sound pressure level	Cooling	Nom.		dBA	78						79				
Operation range	Water side	Cooling	Min.-Max.	°CDB	-15~-15										
	Air side	Cooling	Min.-Max.	°CDB	-18~-48										
Refrigerant	Type / GWP	R-134a / 1,430													
	Circuits	Quantity		2											
Refrigerant charge	Per circuit		kg	29.0	33.0	35.0	38.0	35.0		39.0	42.0	45.0		50.0	
			TCO ₂ eq	41.5	47.2	50.1	54.3	50.1		55.8	60.1	64.4		71.5	
Piping connections	Evaporator water inlet/outlet (OD)		4"											6"	
Unit	Maximum starting current		A	224	240			283	292	312			423	480	498
	Nominal running current (RLA)	Cooling	A	132	145	158	172	185	203	213	253	283	305	324	
	Maximum running current		A	178	199	216	227	239	268	283	328	365	387	410	
Power supply	Phase/Frequency/Voltage		Hz/V	3~/50/400											

Air cooled screw chiller, high efficiency, reduced sound



Cooling only				EWAD-D-XR		240	270	300	320	350	370	390	460	510	560	600				
Cooling capacity	Nom.					kW	242	271	294	321	343	369	393	453	510	559	598			
Power input	Cooling	Nom.					kW	81.6	88.0	96.3	107	117	121	129	154	169	185	200		
Capacity control	Method					Stepless														
	Minimum capacity					%														
EER							2.96	3.07	3.06	3.00	2.94	3.06	3.05	2.95	3.01	3.02	2.99			
ESEER							3.52	3.59	3.58	3.71	3.60	3.89	3.71	3.77	3.99		3.81			
IPLV							4.03	4.11	4.12	4.17	4.13	4.28	4.25	4.36	4.79	4.78	4.47			
Dimensions	Unit	Height					mm						2,355							
		Width					mm						2,234							
		Depth					mm						2,223							
Weight	Unit																			
		kg	3,005		3,385		3,335		4,040		3,340		3,610		4,770		4,785			
Operation weight	kg																			
		3,100		3,500		3,880		5,040												
Water heat exchanger	Type					Single pass shell & tube														
	Water volume																			
	Water flow rate	Cooling	Nom.																	
	Water pressure drop	Cooling	Nom.																	
Air heat exchanger	Type					High efficiency fin and tube type with integral subcooler														
Compressor	Type					Single screw compressor										Asymmetric single screw compressor				
	Quantity					2														
Fan	Type					Direct propeller														
	Quantity																			
	Air flow rate																			
Speed																				
Sound power level	Cooling																			
Sound pressure level	Cooling																			
Operation range	Water side	Cooling	Min.-Max.																	
	Air side	Cooling	Min.-Max.																	
Refrigerant	Type / GWP					R-134a / 1,430														
	Circuits					Quantity														
Refrigerant charge	Per circuit																			
		kg	30.0		31.0		38.0		39.0		40.0		39.0		34.0		45.0		47.0	
Piping connections	Evaporator water inlet/outlet (OD)					4"														
Unit	Maximum starting current																			
	Nominal running current (RLA)	Cooling																		
	Maximum running current																			
Power supply	Phase/Frequency/Voltage					Hz/V														
						3~/50/400														

Air cooled screw chiller, high ambient, standard sound

- › **High ambient**
- › Stepless single-screw compressor
- › Optimised for use with R-134a
- › Large operation range (ambient temperature down to -18°C)
- › MicroTech III controller with superior control logic and easy interface



EWAD-D-HS

MicroTech III

Cooling only				EWAD-D-HS	200	210	230	260	270	290	310	340	380	420	450	480	510	550	590				
Cooling capacity	Nom.		kW	194	208	233	255	272	288	305	334	379	413	446	476	512	545	585					
Power input	Cooling	Nom.		kW	77.9	76.0	83.9	92.1	98.9	105	114	122	129	143	152	164	177	185	194				
Capacity control	Method			Stepless																			
	Minimum capacity			%																			
EER				2.49	2.73	2.77		2.75	2.73	2.68	2.75	2.93	2.90	2.93	2.90	2.89	2.95	3.02					
ESEER				3.02	3.16	3.24	3.11	3.20	3.18	3.17	3.15	3.46	3.50	3.57		3.55	3.60	3.68					
IPLV				3.56	3.74	3.77	3.66	3.74	3.73	3.72	3.64	3.99	4.00	4.05	3.99	4.10	4.18	4.50					
Dimensions	Unit	Height		mm																			
		Width		mm																			
		Depth		mm																			
Weight	Unit	kg		2,239	2,470				2,870				4,040				4,940						
		Operation weight		2,500				2,960				3,300				4,526							
Water heat exchanger	Type			Plate heat exchanger																			
	Water volume			l				95				90				115				170			
	Water flow rate	Cooling	Nom.	l/s	9.3	9.9	11.1	12.2	13.1	13.8	14.6	16.0	18.2	19.8	21.4	22.8	24.5	26.1	28.0				
Water pressure drop	Cooling	Nom.	kPa	32	24	46	52	54	59	64	58	70	46	53	58	51	56	53					
Air heat exchanger	Type			High efficiency fin and tube type with integral subcooler																			
Compressor	Type			Single screw compressor																			
	Quantity			2																			
Fan	Type			Direct propeller																			
	Quantity			4				6				8				10							
	Air flow rate	Nom.		l/s	21,848	21,153	32,772		32,251		31,729		43,696		42,306		54,620						
Sound power level	Cooling		Nom.	dB(A)																			
	Cooling		Nom.	dB(A)																			
Sound pressure level	Cooling		Nom.	dB(A)																			
	Cooling		Nom.	dB(A)																			
Operation range	Water side	Cooling	Min.-Max.	°CDB																			
	Air side	Cooling	Min.-Max.	°CDB																			
Refrigerant	Type / GWP			R-134a / 1,430																			
	Circuits		Quantity	2																			
Refrigerant charge	Per circuit			kg																			
	TCO ₂ eq			kg																			
Piping connections	Evaporator water inlet/outlet (OD)			3"				4"				5"											
	Unit	Maximum starting current		A																			
		Nominal running current (RLA)	Cooling	A																			
Maximum running current	A																						
Power supply	Phase/Frequency/Voltage			Hz/V																			



Air cooled screw chiller, standard efficiency, standard/low sound

- › Stepless single-screw compressor
- › Large operation range (ambient temperature down to -18°C and up to 46°C)
- › 2-3 truly independent refrigerant circuits
- › DX shell and tube evaporator – one pass refrigerant side to minimize pressure drops
- › Partial and total heat recovery option available
- › Standard electronic expansion valve
- › MicroTech III controller with superior control logic and easy interface

Cooling only				EWAD-C-SS/SL																	
Cooling capacity		Nom.		kW		650	740	830	910	970	C11	C12	C13	H14	C15	C16	C17	C18	C19	C20	
Power input	Cooling	Nom.		kW		223	265	302	322	355	382	408	446	479	557	586	627	669	687	721	
Capacity control	Method			Stepless																	
	Minimum capacity			%		12.5								7.0							
EER					2.89	2.80	2.74	2.82	2.71	2.77	2.81	2.95		2.75		2.72	2.69	2.72	2.66		
ESEER					3.79	3.69	3.72	3.65	3.60	3.69	3.63	3.88	3.86		3.73	3.68	3.59	3.71	3.68		
IPLV					4.32	4.17	4.18	4.25	4.16	4.17	4.21	4.42		4.28	4.18	4.15	4.24	4.19	4.21		
Dimensions	Unit	Height		mm		2,540															
		Width		mm		2,285															
		Depth		mm		6,285				7,185	8,085	8,985		10,285	11,185			12,085			
Weight (SS)	Unit			kg		5,330	5,740	5,760	6,280	6,560	7,010	7,280	7,900		10,320	10,710	10,770	11,240	11,600		
	Operation weight			kg		5,610	5,990	6,010	6,530	6,810	7,250	7,520	8,280		10,730	11,110	11,260	12,110	12,480		
Weight (SL)	Unit			kg		5,920	6,030	6,050	6,570	6,850	7,300	7,570	8,190		10,770	11,150	11,210	11,680	12,040		
	Operation weight			kg		6,200	6,280	6,300	6,820	7,100	7,540	7,810	8,570		11,170	11,550	11,700	12,560	12,920		
Water heat exchanger	Type			Single pass shell & tube																	
	Water flow rate	Cooling	Nom.	I/s	30.9	35.5	39.7	43.5	46.1	50.8	55.0	62.9	67.6	73.4	77.4	81.8	86.0	89.5	91.7		
	Water pressure drop	Cooling	Nom.	kPa	73	54	53	62	69	64	74	54	58	62	68	75	36	39	40		
	Water volume				I	266		251		243		386		408		474	850				
Air heat exchanger	Type			High efficiency fin and tube type																	
Compressor	Type			Asymmetric single screw compressor																	
	Quantity			2						3											
Fan	Type			Direct propeller																	
	Quantity			10				12		14	16	18		20	22			24			
	Air flow rate	Nom.		I/s	53,442			64,131		74,819	85,508	96,196		106,885	117,573			128,262			
	Speed			rpm	900																
Sound power level (SS)	Cooling	Nom.		dBA	102	100		101		102			103			104					
Sound power level (SL)	Cooling	Nom.		dBA	96		98	97	98			99	100		101						
Sound pressure level (SS)	Cooling	Nom.		dBA	81	80			81						82						
Sound pressure level (SL)	Cooling	Nom.		dBA	76			77						78							
Operation range	Air side	Cooling	Min.-Max.	°CDB	-18~46																
	Water side	Cooling	Min.-Max.	°CDB	-8~15																
Refrigerant	Type / GWP			R-134a / 1,430																	
	Circuits			Quantity	2						3										
Refrigerant charge	Per circuit			kg	64.0		76.5	80.0	91.0	94.0	110.0	130.0	73.3	86.7			91.7	101.7			
				TCO ₂ eq	91.5		109.4	114.4	130.1	134.4	157.3	185.9	104.9	123.9			131.1	145.4			
Piping connections	Evaporator water inlet/outlet (OD)			168.3mm						219.1mm						273mm					
	Unit	Starting current		Max	A	604	649		915	962	1,017	1,021	1,068	1,081	1,312	1,363	1,367	1,410	1,456	1,470	
		Running current		Cooling	Nom.	A	366	432	492	524	577	624	667	726	773	909	959.0	1,023	1,092	1,116	1,164
			Max	A	476	545	589	656	715	787	859	921	974	1,144	1,217	1,281	1,334	1,395	1,449		
Power supply	Phase/Frequency/Voltage			Hz/V	3~/50/400																

Air cooled screw chiller, standard efficiency, reduced sound



Cooling only				EWAD-C-SR																					
Cooling capacity		Nom.		kW		620	720	790	880	920	C10	C11	C12	H14	C13	C14	C15	C16	C17	C18	C19				
Power input		Cooling		Nom.		kW		226	276	317	334	373	398	422	461	499	522	582	609	654	706	722	762		
Capacity control		Method		Stepless																					
		Minimum capacity		%		12.5										7.0									
EER						2.74	2.59	2.48	2.61	2.46	2.55	2.63	2.75	2.63	2.61	2.52	2.54	2.47	2.42	2.48	2.40				
ESEER						3.91	3.78	3.81	3.79	3.98	3.76	3.95	3.92	3.81	3.78	3.70	3.72	3.66	3.70	3.71	3.66				
IPLV						4.39	4.41	4.19	4.29	4.21		4.33	4.52	4.35	4.29	4.27	4.28	4.23	4.24	4.27	4.21				
Dimensions		Unit		Height		mm		2,540																	
				Width		mm		2,285																	
				Depth		mm		6,285				7,185	8,085	10,285			11,185			12,085					
Weight		Unit		kg		5,920	6,030	6,050	6,570	6,850	7,300	7,570	8,190		10,750	10,770	11,150	11,210	11,680	12,040					
		Operation weight		kg		6,200	6,280	6,300	6,820	7,100	7,540	7,810	8,570		11,170		11,550	11,700	12,560	12,920					
Water heat exchanger		Type		Single pass shell & tube																					
		Water flow rate		Cooling		Nom.		l/s		29.5	34.1	37.6	41.8	44.0	48.7	53.1	60.6	63.0	65.2	70.2	74.2	77.3	81.8	85.6	87.5
		Water pressure drop		Cooling		Nom.		kPa		43	50	48	58	63	60	69	50	54	45	57	63	46	33	36	37
		Water volume		l		266		251		243		386		421	408		474	850							
Air heat exchanger		Type		High efficiency fin and tube type																					
Compressor		Type		Asymmetric single screw compressor																					
		Quantity		2																3					
Fan		Type		Direct propeller																					
		Quantity		10				12		14	16	18		20		22		24							
		Air flow rate		Nom.		l/s		41,007		49,208		57,410	65,611	73,812		82,014		90,215		98,417					
		Speed		rpm		700																			
Sound power level		Cooling		Nom.		dBA		92				93		94				95				96			
Sound pressure level		Cooling		Nom.		dBA		71	72		73										74				
Operation range		Air side		Cooling		Min.-Max.		°CDB		-18~-46															
		Water side		Cooling		Min.-Max.		°CDB		-8~-15															
Refrigerant		Type / GWP		R-134a / 1,430																					
		Circuits		Quantity		2																3			
Refrigerant charge		Per circuit		kg		64.0		76.5	80.0	91.0	94.0	110.0		86.7				91.7		101.7					
				TCO ₂ eq		91.5		109.4	114.4	130.1	134.4	157.3		123.9				131.1		145.4					
Piping connections		Evaporator water inlet/outlet (OD)		168.3mm										219.1mm					273mm						
Unit		Starting current		Max		A		597	642		906	953	1,007	1,010	1,055	1,068	1,241	1,292	1,344	1,346	1,389	1,434	1,447		
		Running current		Cooling		Nom.		A		371	450	518	548	609	654	694	755	811	857	954	1,002	1,075	1,158	1,179	1,238
				Max		A		462	531	575	639	698	767	837	895	949	1,052	1,116	1,186	1,250	1,303	1,362	1,415		
Power supply		Phase/Frequency/Voltage		Hz/V		3~/50/400																			

Air cooled screw chiller, high efficiency, standard/low sound

- › Stepless single-screw compressor
- › Large operation range (ambient temperature down to -18°C and up to 50°C)
- › 2-3 truly independent refrigerant circuits
- › DX shell and tube evaporator – one pass refrigerant side to minimize pressure drops
- › Partial and total heat recovery option available
- › Standard electronic expansion valve
- › MicroTech III controller with superior control logic and easy interface

Cooling only				EWAD-C-XS/XL																			
Cooling capacity		Nom.		kW		760	830	890	990	C10	C11	C12	C13	H14	H15	C16	C17	C18	C19	C20	C21	C22	
Power input	Cooling	Nom.		kW		237	256	282	311	343	367	404	416	450	483	510	541	569	598	619	648	678	
Capacity control	Method			Stepless																			
	Minimum capacity			12.5									7.0										
EER					3.17	3.22	3.14	3.20	3.12	3.25	3.15	3.23	3.13	3.14	3.12	3.10	3.09	3.06	3.00	2.95			
ESEER					3.77	3.92	3.81	3.91	3.84	3.99	3.86	4.05	4.04	4.06	4.00	3.96	3.94	3.93	4.02	3.91	3.89		
IPLV					4.48	4.52	4.50	4.44	4.50	4.47	4.60	4.71	4.81	4.58	4.59	4.51	4.53	4.57	4.42	4.47			
Dimensions	Unit	Height		mm		2,540																	
		Width		mm		2,285																	
		Depth		mm		6,285	7,185	8,085			9,885			12,085	12,985	13,885	14,785						
Weight (XS)	Unit			kg		5,990	6,340	6,360	7,190	7,470	8,220	8,240	8,900			11,570	11,900	12,260	12,600				
	Operation weight			kg		6,240	6,580	6,600	7,600	7,870	8,610	8,630	9,890			12,430	12,760	13,140	13,470				
Weight (XL)	Unit			kg		6,280	6,630	6,650	7,480	7,760	8,510	8,530	9,190			12,010	12,350	12,700	13,040				
	Operation weight			kg		6,520	6,870	6,890	7,880	8,160	8,900	8,920	10,180			12,870	13,200	13,580	13,910				
Water heat exchanger	Type			Single pass shell & tube																			
	Water flow rate	Cooling	Nom.	I/s	36.1	39.6	42.4	47.8	51.2	57.1	61.1	64.4	67.5	72.8	76.1	80.4	84.4	88.6	90.7	93.2	95.8		
	Water pressure drop	Cooling	Nom.	kPa	81	57	64	61	69	45	51	68	77	84	62	68	74	39	41	43			
	Water volume			I	251	243	403			386			979			850	871	850					
Air heat exchanger	Type			High efficiency fin and tube type																			
Compressor	Type			Asymmetric single screw compressor																			
	Quantity			2						3													
Fan	Type			Direct propeller																			
	Quantity			12	14	16	20			24	26	28	30										
	Air flow rate	Nom.		I/s	64,131	74,819	85,508			106,885			128,262	138,950	149,639	160,327							
	Speed			rpm	900																		
Sound power level (XS)	Cooling	Nom.		dBA	100	101		102		103			104										
Sound power level (XL)	Cooling	Nom.		dBA	97			98		99			100										
Sound pressure level (XS)	Cooling	Nom.		dBA	80			81		80			81										
Sound pressure level (XL)	Cooling	Nom.		dBA	76	77						78											
Operation range	Air side	Cooling	Min.-Max.	°CDB	-18~50																		
	Water side	Cooling	Min.-Max.	°CDB	-8~15																		
Refrigerant	Type / GWP			R-134a / 1,430																			
	Circuits			Quantity	2						3												
Refrigerant charge	Per circuit			kg	75.0	81.0	91.0	100.0	115.0	117.5	125.0	145.5	125.0	99.0	82.7	103.3	109.0	113.3	120.0				
				TCO ₂ eq	107.3	115.8	130.1	143.0	164.5	168.0	178.8	208.1	178.8	141.6	118.2	147.8	155.9	162.1	171.6				
Piping connections	Evaporator water inlet/outlet (OD)			168.3mm						219.1mm						273mm							
Unit	Starting current			Max	A	618	657	923	970	1,029			1,072	1,085	1,268	1,328	1,387	1,430	1,472	1,486			
	Running current	Cooling	Nom.	A	387	423	463	511	559	607	667	686	731	778	835	885	934.0	984	1,018	1,059	1,100		
		Max			A	510	561	605	672	731	811	875		929	982	1,096	1,168	1,241	1,313	1,366	1,419	1,473	
Power supply	Phase/Frequency/Voltage			Hz/V	3~/50/400																		

Air cooled screw chiller, high efficiency, reduced sound



EWAD-C-XS/XL/XR

MicroTech III

Cooling only				EWAD-C-XR																			
				740	810	870	970	C10	C11	C12	C13	H14	H15	C16	C17	C18	C19	C20	C21	C22			
Cooling capacity	Nom.	kW		732	808	862	970	1,036	1,164	1,243	1,297	1,360	1,460	1,544	1,632	1,715	1,805	1,849	1,897	1,947			
Power input	Cooling	kW		238	257	285	313	348	369	409	420	460	498	518	548	574	604	629	662	696			
Capacity control	Method	Stepless																					
	Minimum capacity	%		12.5									7.0										
EER				3.07	3.15	3.03	3.10	2.98	3.16	3.04	3.09	2.96	2.93	2.98		2.99		2.94	2.87	2.80			
ESEER				4.01	4.16	4.01	4.12	4.01	4.21	4.07	4.10		4.12	4.08	4.00	4.05	4.00	4.09	3.96	3.94			
IPLV				4.56	4.62	4.51	4.63	4.59	4.65	4.61	4.63	4.74	4.83	4.67	4.65	4.63	4.69	4.54	4.53				
Dimensions	Unit	Height	mm											2,540									
		Width	mm											2,285									
		Depth	mm	6,285	7,185		8,085		8,530		9,885		12,085	12,985	13,885		14,785						
Weight	Unit	kg		6,280	6,630	6,650	7,480	7,760	8,510	8,530	9,190		12,010	12,350	12,700		13,040						
	Operation weight	kg		6,520	6,870	6,890	7,880	8,160	8,900	8,920	10,180		12,870	13,200	13,580		13,910						
Water heat exchanger	Type	Single pass shell & tube																					
	Water flow rate	Cooling	Nom.	l/s	35.1	38.7	41.3	46.5	49.7	55.7	59.5	62.1	65.2	70.0	74.0	78.2	82.2	86.5	88.5	90.7	93.1		
	Water pressure drop	Cooling	Nom.	kPa	77	54	61	58	65	43	49	64	73	79	59	65	71	37	39	41			
	Water volume	l		251	243		403		386		979		850		871		850						
Air heat exchanger	Type	High efficiency fin and tube type																					
Compressor	Type	Asymmetric single screw compressor																					
	Quantity	2										3											
Fan	Type	Direct propeller																					
	Quantity	12			14			16			20			24		26		28		30			
	Air flow rate	Nom.	l/s		49,208	57,410		65,611		82,014			98,417		106,618		114,819		123,021				
	Speed	rpm												700									
Sound power level	Cooling	Nom.	dB(A)		92			94			95			96			97						
Sound pressure level	Cooling	Nom.	dB(A)		72			73			72			73			74						
Operation range	Air side	Cooling	Min.-Max.	°CDB																-18~-50			
	Water side	Cooling	Min.-Max.	°CDB																-8~-15			
Refrigerant	Type / GWP	R-134a / 1,430																					
	Circuits	Quantity		2										3									
	GWP	1,430																					
Refrigerant charge	Per circuit	kg		75.0	81.0	91.0	100.0	115.0	117.5	125.0	124.0	103.3	109.0	113.3	120.0		125.0						
		TCO ₂ eq	107.3	115.8	130.1	143.0	164.5	168.0	178.8	177.3	147.8	155.9	162.1	171.6		178.8							
Piping connections	Evaporator water inlet/outlet (OD)		168.3mm			219.1mm			273mm														
Unit	Starting current	Max		A	610	647		911	959	1,015		1,058	1,071	1,246	1,303	1,359	1,402	1,444	1,458				
	Running current	Cooling	Nom.	A	392	426	470	518	572	613	679	699	753	807	854	903	951	1,000	1,040	1,087	1,136		
		Max	A		493	542	585	649	708	783	847		901	954	1,063	1,132	1,201	1,271	1,324	1,377	1,431		
Power supply	Phase/Frequency/Voltage		Hz/V		3~/50/400																		

Air cooled screw chiller, premium efficiency, standard/low sound

- › Stepless single-screw compressor
- › Excellent part load efficiency
- › Large operation range (ambient temperature down to -18°C and up to 52°C)
- › 2 truly independent refrigerant circuits
- › DX shell and tube evaporator – one pass refrigerant side to minimize pressure drops
- › Partial and total heat recovery option available
- › Standard electronic expansion valve
- › MicroTech III controller with superior control logic and easy interface

Cooling only				EWAD-C-PS/PL	820	890	980	C11	C12	C13	C14	C15	C16
Cooling capacity	Nom.			kW	818	886	973	1,070	1,153	1,274	1,384	1,467	1,554
Power input	Cooling	Nom.		kW	229	253	276	306	335	368	402	432	461
Capacity control	Method				Stepless								
	Minimum capacity			%	12.5								
EER					3.57	3.51	3.52	3.49	3.44	3.46	3.44	3.40	3.37
ESEER					4.22	4.25	4.30	4.29	4.14	4.23	4.07	4.06	4.03
IPLV					4.78	4.67	4.79	4.69	4.73	4.68	4.73		4.71
Dimensions	Unit	Height		mm	2,540								
		Width		mm	2,285								
		Depth		mm	8,985		9,885		11,185		12,085		
Weight (PS)	Unit			kg	7,530		7,660	8,290	8,550	9,390	9,730		
	Operation weight			kg	8,130		8,700	9,330	9,590	10,380	10,720		
Weight (PL)	Unit			kg	7,820		7,950	8,580	8,840	10,380	10,720		
	Operation weight			kg	8,420		8,990	9,620	9,880	10,670	11,010		
Water heat exchanger	Type				Single pass shell & tube								
	Water flow rate	Cooling	Nom.	l/s	39.2	42.5	46.5	51.2	55.2	61.0	66.3	70.3	74.5
	Water pressure drop	Cooling	Nom.	kPa	58	67	31	61	70	60	70	81	88
	Water volume			l	599		1,043	1,027		995	979		
Air heat exchanger	Type				High efficiency fin and tube type								
Compressor	Type				Asymmetric single screw compressor								
	Quantity				2								
Fan	Type				Direct propeller								
	Quantity				18			20		22	24		
	Air flow rate	Nom.		l/s	96,196			106,885		117,573	128,262		
	Speed			rpm	900								
Sound power level (PS)	Cooling	Nom.		dBA	101			102		103		104	
Sound power level (PL)	Cooling	Nom.		dBA	98			99	100	99	100		
Sound pressure level (PS)	Cooling	Nom.		dBA	80				81	80	81		
Sound pressure level (PL)	Cooling	Nom.		dBA				77			78		
Operation range	Air side	Cooling	Min.~Max.	°CDB	-18~-52								
	Water side	Cooling	Min.~Max.	°CDB	-8~-15								
Refrigerant	Type / GWP				R-134a / 1,430								
	Circuits	Quantity			2								
Refrigerant charge	Per circuit			kg	102.0			115.0	120.0	137.5	140.0		
				TCO ₂ eq	145.9			164.5	171.6	196.6	200.2		
Piping connections	Evaporator water inlet/outlet (OD)				219.1mm			273mm					
Unit	Starting current	Max		A	630	665		702	978	1,037		1,080	1,093
	Running current	Cooling	Nom.	A	386	424	465	511	555	614	671	711	752
		Max		A	534	577	621	670	747	819	891	945	998
Power supply	Phase/Frequency/Voltage			Hz/V	3~/50/400								

Air cooled screw chiller, premium efficiency, reduced sound



EWAD-C-PS/PL/PR

MicroTech III

Cooling only				EWAD-C-PR	810	880	960	C10	C11	C13	C14	C15	C16	
Cooling capacity	Nom.		kW	806	871	954	1,049	1,127	1,246	1,353	1,432	1,513		
Power input	Cooling	Nom.		kW	222	248	275	303	335	369	402	432	465	
Capacity control	Method			Stepless										
	Minimum capacity			%	12.5									
EER				3.63	3.51	3.47	3.46	3.36	3.38	3.36	3.32	3.25		
ESEER				4.39	4.33	4.40	4.35	4.25	4.33	4.26	4.23	4.15		
IPLV				5.07	4.89		4.92	4.82	4.81	4.85		4.79		
Dimensions	Unit	Height		mm	2,540									
		Width		mm	2,285									
		Depth		mm	8,985		9,885		11,185		12,085			
Weight	Unit		kg	7,820		7,950		8,580		8,840		10,380		
	Operation weight			kg	8,420		8,990		9,620		9,880		10,670	
Water heat exchanger	Type			Single pass shell & tube										
	Water flow rate	Cooling	Nom.	l/s	38.6	41.7	45.6	50.2	54.0	59.7	64.8	68.7	72.6	
	Water pressure drop	Cooling	Nom.	kPa	56	65	30	59	67	58	67	77	84	
	Water volume			l	599		1,043		1,027		995		979	
Air heat exchanger	Type			High efficiency fin and tube type										
Compressor	Type			Asymmetric single screw compressor										
	Quantity			2										
Fan	Type			Direct propeller										
	Quantity			18		20		22		24				
	Air flow rate	Nom.		l/s	73,812		82,014		90,215		98,417			
	Speed			rpm	700									
Sound power level	Cooling	Nom.		dB(A)	93			94			95			
Sound pressure level	Cooling	Nom.		dB(A)	71			72			73			
Operation range	Air side	Cooling	Min.~Max.	°CDB	-18~52									
	Water side	Cooling	Min.~Max.	°CDB	-8~15									
Refrigerant	Type / GWP			R-134a / 1,430										
	Circuits		Quantity	2										
Refrigerant charge	Per circuit			kg	102.0		115.0		120.0		137.5		140.0	
				TCO ₂ eq	145.9		164.5		171.6		196.6		200.2	
Piping connections	Evaporator water inlet/outlet (OD)			219.1mm				273mm						
Unit	Starting current		Max	A	618	653		917		964		1,020		
	Running current	Cooling	Nom.	A	375	416	461	506	555	614	671	717	764	
		Max		A	509	552	596	660	719	788	858	911	964	
Power supply	Phase/Frequency/Voltage			Hz/V	3~/50/400									

Air cooled screw inverter chiller, high efficiency, standard/low sound

- › High efficiency with leader-of-class ESEER
- › Inverter stepless single-screw compressor
- › Highly efficient fans with patented blade profile for quiet operation
- › Extensive option list (heat recovery option available)
- › Wide operating range
- › Low starting current
- › MicroTech III controller with superior control logic and easy interface

Cooling only				EWAD-CZXS/XL														
Cooling capacity		Nom.		kW	740	830	900	C10	C11	C12	C13	C14	C15	C16	C17	C18		
Power input		Cooling	Nom.	kW	239	269	309	343	380	404	447	494	538	564	596	619		
Capacity control		Method		Stepless														
		Minimum capacity		%	20.0								13.0					
EER					3.07		2.90	3.01	2.87	3.05	2.92	2.93	2.86		2.85	2.90		
ESEER					4.72	4.89	4.88	4.91	4.70		4.51	4.73	4.83	4.59	4.62	4.61		
IPLV					5.68	5.72	5.79	5.73	5.56	5.58	5.45	5.61	5.75	5.65	5.46	5.29		
Dimensions		Unit		Height	mm													
				Width	mm													
				Depth	mm													
Weight (XS)		Unit		kg	6,000	6,620	6,870	7,440		8,570	8,970	9,600	9,940	11,370	12,190	12,920		
		Operation weight		kg	6,250	6,860	7,110	7,880		8,960	9,360	9,980	10,320	12,220	13,040	13,790		
Weight (XL)		Unit		kg	6,280	6,900	7,150	7,720		8,850	9,250	9,880	10,220	11,790	12,610	13,340		
		Operation weight		kg	6,530	7,140	7,390	8,160		9,240	9,640	10,260	10,600	12,640	13,460	14,210		
Water heat exchanger		Type		Single pass shell & tube														
		Water flow rate	Cooling	Nom.	l/s	35.2	39.7	43.0	49.5	52.3	59.0	62.4	69.2	73.7	77.4	81.5	86.0	
		Water pressure drop	Cooling	Nom.	kPa	83	58	65	63	70	47	52	62	72	63	69	65	
		Water volume		l	248	241		441			383		374		850		871	
Air heat exchanger		Type		High efficiency fin and tube type														
Compressor		Type		Asymmetric single screw compressor														
		Quantity		2											3			
Fan		Type		Direct propeller														
		Quantity			12	14	16		20		22	24		26	28			
		Air flow rate	Nom.	l/s	65,026	75,863		86,701		108,376		119,214	130,051	129,455	140,143	151,130		
		Speed		rpm	900													
Sound power level (XS)		Cooling	Nom.	dBA	102	103			104			106						
Sound power level (XL)		Cooling	Nom.	dBA	99	100			101			103						
Sound pressure level (XS)		Cooling	Nom.	dBA	81								83					
Sound pressure level (XL)		Cooling	Nom.	dBA	78								80					
Operation range		Air side	Cooling	Min.-Max.	°CDB	-18~-50												
		Water side	Cooling	Min.-Max.	°CDB	-8~-15												
Refrigerant		Type / GWP		R-134a / 1,430														
		Circuits		Quantity	2											3		
Refrigerant charge		Per circuit		kg	73.0	81.0		100.0		125.0		140.0	106.7	113.3	116.7			
				TCO ₂ eq	104.4	115.8		143.0		178.8		200.2	152.5	162.1	166.8			
Piping connections		Evaporator water inlet/outlet (OD)		mm														
Unit		Starting current		Max	A	377	420	451	501	540	590	626	709	772	848	899	949	
		Running current		Cooling	Nom.	A	406	442	485	537	591	636	698	769	837	881	931	970
				Max	A	529	584	632	697	755	824	877	979	1,081	1,132	1,193	1,255	
Power supply		Phase/Frequency/Voltage		Hz/V	3~/50/400													

Air cooled screw inverter chiller, high efficiency, reduced sound



EWAD-CZXS/XL/XR

MicroTech III

Cooling only				EWAD-CZXR		700	790	850	980	C10	C11	C12	C13	C14	C15	C16	C17		
Cooling capacity	Nom.		kW	696	786	849	972	1,027	1,166	1,231	1,327	1,437	1,539	1,624	1,706				
Power input	Cooling		Nom.	kW	246	274	318	351	393	412	459	493	523	585	617	638			
Capacity control	Method		Stepless																
	Minimum capacity		%	20.0										13.0					
EER				2.83	2.86	2.67	2.77	2.61	2.83	2.68	2.69	2.75	2.63		2.67				
ESEER				5.23	5.39	5.36	5.41	5.11	5.15	4.80	5.12	5.22	5.10	4.83	4.77				
IPLV				6.14	6.32	6.37	6.34	6.05	5.96	5.67	6.03	6.21	6.17	5.89	5.85				
Dimensions	Unit	Height		2,540															
		Width		2,285															
		Depth		6,725	7,625		8,525		10,325		11,625	12,525		13,425	14,325				
Weight	Unit		kg	6,470	7,100	7,360	7,950		9,120	9,530	10,180	10,530	12,150	12,990	13,740				
	Operation weight		kg	6,720	7,340	7,600	8,390		9,500	9,920	10,550	10,910	13,000	13,840	14,610				
Water heat exchanger	Type		Single pass shell & tube																
	Water flow rate	Cooling	Nom.	l/s	33.4	37.6	40.7	46.6	49.2	55.8	58.9	63.6	68.8	73.7	77.8	81.7			
	Water pressure drop	Cooling	Nom.	kPa	76	54	59	58	64	43	48	57	66	57	63	60			
	Water volume			l	248	241		441		383		374		850		871			
Air heat exchanger	Type		High efficiency fin and tube type																
Compressor	Type		Asymmetric single screw compressor																
	Quantity		2												3				
Fan	Type		Direct propeller																
	Quantity		12	14	16		20		22	24		26	28						
	Air flow rate	Nom.	l/s	49,843	58,151		66,458		83,072		91,380	99,687		107,994	116,301				
	Speed			rpm	700														
Sound power level	Cooling	Nom.	dB(A)	95	96				97				99						
Sound pressure level	Cooling	Nom.	dB(A)	74								76							
Operation range	Air side	Cooling	Min.-Max.	-18~50															
	Water side	Cooling	Min.-Max.	-8~15															
Refrigerant	Type / GWP		R-134a / 1,430																
	Circuits	Quantity		2										3					
Refrigerant charge	Per circuit		kg	73.0	81.0		100.0		125.0		140.0	106.7	113.3	116.7					
			TCO ₂ eq	104.4	115.8		143.0		178.8		200.2	152.5	162.1	166.8					
Piping connections	Evaporator water inlet/outlet (OD)		168.3mm						219.1mm						273mm				
Unit	Starting current		Max	A	369	410	442	490	528	576	612	693	756	825	873	921			
	Running current	Cooling	Nom.	A	416	449	498	549	610	647	715	789	859	912	960	998			
		Max		A	512	565	612	675	732	796	849	949	1,048	1,098	1,157	1,215			
Power supply	Phase/Frequency/Voltage		Hz/V	3~/50/400															

Air cooled screw chiller with free cooling, high efficiency, standard/low sound

- › Free cooling chiller for space cooling and industrial processes
- › Stepless single-screw compressor
- › Optimised for use with R-134a
- › Greater energy savings and reduced CO₂ emissions during cold season
- › Wide operating range
- › MicroTech III controller with superior control logic and easy interface

Cooling only				EWAD-CFXS/XL															
				640	770	850	900	C10	C11	C12	C13	C14	C15	C16					
Cooling capacity	Nom.	kW		640 (1)	772 (1)	852 (1)	902 (1)	1,027 (1)	1,089 (1)	1,269 (1)	1,349 (1)	1,435 (1)	1,493 (1)	1,555 (1)					
Free cooling capacity	Nom.	kW		415 (2)	510 (2)	583 (2)	612 (2)	701 (2)	734 (2)	902 (2)	957 (2)	963 (2)	1,013 (2)	1,039 (2)					
Mechanical capacity		kW		225 (2)	262 (2)	269 (2)	290 (2)	325 (2)	355 (2)	366 (2)	392 (2)	472 (2)	480 (2)	517 (2)					
Air temperature for free cooling	100%	°C		-0.8	-0.1	1.2	0.4	0.9	0.1	2.9	2.1	1.3	0.7	0.1					
Power input	Cooling	Nom.	kW	257 (1) / 53.7 (2)	272 (1) / 62.0 (2)	293 (1) / 64.7 (2)	324 (1) / 69.8 (2)	360 (1) / 75.7 (2)	399 (1) / 83.4 (2)	397 (1) / 86.4 (2)	439 (1) / 92.8 (2)	454 (1) / 101 (2)	492 (1) / 109 (2)	530 (1) / 115 (2)					
Capacity control	Method	Stepless																	
	Minimum capacity	%		12.5															
EER				2.49 (1) / 11.91 (2)	2.84 (1) / 12.44 (2)	2.90 (1) / 13.17 (2)	2.78 (1) / 12.93 (2)	2.85 (1) / 13.56 (2)	2.73 (1) / 13.05 (2)	3.19 (1) / 14.68 (2)	3.08 (1) / 14.55 (2)	3.16 (1) / 14.21 (2)	3.04 (1) / 13.72 (2)	2.93 (1) / 13.50 (2)					
ESEER				3.44	3.52	3.78	3.50	3.74	3.54	3.88	3.78	4.01	3.96	3.85					
IPLV				3.86	4.03	4.10	4.05	4.00	3.95	4.36	4.25	4.36	4.35	4.26					
Dimensions	Unit	Height	mm	2,565															
		Width	mm	2,480															
		Depth	mm	6,300	7,200	8,100				9,000				10,800					
			mm	6,300	7,200	8,100				9,000				10,800					
Weight (XS)	Unit	kg	7,760	8,340	8,900				10,160	10,420	11,900				12,540	12,620	12,670		
		Operation weight	kg	8,515	9,100	9,705				11,169	11,429	13,276				14,516	14,596	14,646	
Weight (XL)	Unit	kg	8,050	8,620	9,190				10,450	10,710	12,190				12,830	12,910	12,960		
		Operation weight	kg	8,795	9,390	9,995				11,459	11,719	13,566				14,806	14,886	14,936	
Water heat exchanger	Type	Single pass shell & tube																	
		Water volume	l	741	771	808				1,012		1,372		1,965					
		Water flow rate	Cooling	Nom.	l/s	27.8 (1) / 27.8 (2)	33.5 (1) / 33.5 (2)	37.0 (1) / 37.0 (2)	39.2 (1) / 39.2 (2)	44.6 (1) / 44.6 (2)	47.3 (1) / 47.3 (2)	55.1 (1) / 55.1 (2)	58.6 (1) / 58.6 (2)	62.4 (1) / 62.4 (2)	64.9 (1) / 64.9 (2)	67.6 (1) / 67.6 (2)			
		Water pressure drop	Cooling	Nom.	kPa	85 (1) / 128 (2)	105 (1) / 172 (2)	90 (1) / 178 (2)	101 (1) / 198 (2)	111 (1) / 245 (2)	124 (1) / 272 (2)	98 (1) / 232 (2)	110 (1) / 259 (2)	139 (1) / 305 (2)	150 (1) / 328 (2)	162 (1) / 354 (2)			
Air heat exchanger	Type	High efficiency fin and tube type with integral subcooler																	
Compressor	Type	Asymmetric single screw compressor																	
	Quantity	2																	
Fan	Type	Direct propeller																	
		Quantity	20																
		Air flow rate	Nom.	l/s	50,368	60,441	70,515				80,588				95,253				
		Speed	rpm	920															
Sound power level (XS)	Cooling	Nom.	dBA	100				101				102				103			
Sound power level (XL)	Cooling	Nom.	dBA	96	97				98				99						
Sound pressure level (XS)	Cooling	Nom.	dBA	79	80				81				80						
Sound pressure level (XL)	Cooling	Nom.	dBA	76				77				77							
Operation range	Water side	Cooling	Min.-Max.	°CDB -8~15															
	Air side	Cooling	Min.-Max.	°CDB -20~45															
Refrigerant	Type / GWP	R-134a / 1,430																	
	Circuits	Quantity	2																
Refrigerant charge	Per circuit	kg	64.0	73.0	81.0				91.0		107.0		112.5	124.0					
		TCO ₂ eq	91.5	104.4	115.8				130.1		153.0		160.9	177.3					
Piping connections	Evaporator water inlet/outlet (OD)			DN150PN16(168.3mm)															
	Unit	Maximum starting current	A	605	619	658				924	971	1,030							
		Nominal running current (RLA)	Cooling	A	404	430	467	515	568	628	636	701	720	773	825				
Maximum running current	A	476	510	561	605	672	731	811	875				929	982					
Power supply	Phase/Frequency/Voltage	Hz/V		3~/50/400															

(1) Cooling; entering evaporator water temp. 16°C; leaving evaporator water temp. 10°C; ambient air temp. 35°C; full load operation. (2) Data is calculated at ambient air temperature 5°C, inlet water temperature 16°C.

Air cooled screw chiller with free cooling, high efficiency, reduced sound



Cooling only				EWAD-CFXR	600	740	820	870	980	C10	C11	C12	C13	C14	C15
Cooling capacity	Nom.		kW	602 (1)	739 (1)	821 (1)	866 (1)	981 (1)	1,034 (1)	1,229 (1)	1,302 (1)	1,374 (1)	1,424 (1)	1,476 (1)	
Free cooling capacity	Nom.		kW	374 (2)	468 (2)	539 (2)	562 (2)	644 (2)	670 (2)	825 (2)	866 (2)	889 (2)	909 (2)	929 (2)	
Mechanical capacity			kW	228 (2)	271 (2)	282 (2)	304 (2)	337 (2)	364 (2)	404 (2)	435 (2)	486 (2)	515 (2)	547 (2)	
Air temperature for free cooling	100%		°C	-2.3	-1.9	-0.6	-1.5	-0.9	-1.7	0.7	-0.2	-1.1	-1.6	-2.3	
Power input	Cooling	Nom.	kW	263 (1) / 46.6 (2)	278 (1) / 56.2 (2)	299 (1) / 58.5 (2)	334 (1) / 63.1 (2)	368 (1) / 68.5 (2)	412 (1) / 74.4 (2)	403 (1) / 80.0 (2)	450 (1) / 87.5 (2)	466 (1) / 93.4 (2)	511 (1) / 103 (2)	556 (1) / 109 (2)	
Capacity control	Method			Stepless											
	Minimum capacity		%	12.5											
EER				2.29 (1) / 12.91 (2)	2.66 (1) / 13.17 (2)	2.75 (1) / 14.04 (2)	2.59 (1) / 13.71 (2)	2.67 (1) / 14.33 (2)	2.51 (1) / 13.89 (2)	3.05 (1) / 15.36 (2)	2.90 (1) / 14.87 (2)	2.95 (1) / 14.7(2)	2.79 (1) / 13.85 (2)	2.66 (1) / 13.56 (2)	
ESEER				3.59	3.66	3.89	3.62	3.83	3.63	4.13	3.89	4.09	4.02	3.92	
IPLV				4.09	4.15	4.16	4.20	4.10	4.08	4.42	4.37	4.42	4.28		
Dimensions	Unit	Height	mm	2,565											
		Width	mm	2,480											
		Depth	mm	6,300	7,200	8,100	9,000	10,800							
Weight	Unit		kg	8,050	8,620	9,190	10,450	10,710	12,190	12,830	12,910	12,960			
		Operation weight	kg	8,795	9,390	9,995	11,459	11,719	13,566	14,806	14,886	14,936			
Water heat exchanger	Type			Single pass shell & tube											
		Water volume	l	741	771	808	1,012	1,372	1,965						
		Water flow rate	Cooling	Nom.	l/s	26.2 (1) / 26.2 (2)	32.1 (1) / 32.1 (2)	35.7 (1) / 35.7 (2)	37.6 (1) / 37.6 (2)	42.6 (1) / 42.6 (2)	44.9 (1) / 44.9 (2)	53.4 (1) / 53.4 (2)	56.6 (1) / 56.6 (2)	59.7 (1) / 59.7 (2)	61.9 (1) / 61.9 (2)
	Water pressure drop	Cooling	Nom.	kPa	76 (1) / 115 (2)	97 (1) / 159 (2)	84 (1) / 167 (2)	93 (1) / 184 (2)	102 (1) / 225 (2)	113 (1) / 248 (2)	92 (1) / 219 (2)	103 (1) / 243 (2)	128 (1) / 282 (2)	137 (1) / 301 (2)	146 (1) / 321 (2)
Air heat exchanger	Type			High efficiency fin and tube type with integral subcooler											
Compressor	Type			Asymm single screw											
	Quantity			2											
Fan	Type			Direct propeller											
	Quantity			10	12	14	16	20							
	Air flow rate	Nom.	l/s	38,935	46,722	54,508	62,295	73,011							
	Speed		rpm	715											
Sound power level	Cooling	Nom.	dB(A)	92											
Sound pressure level	Cooling	Nom.	dB(A)	71	72	73	72	73							
Operation range	Water side	Cooling	Min.-Max.	-8~-15											
	Air side	Cooling	Min.-Max.	-20~45											
Refrigerant	Type / GWP			R-134a / 1,430											
	Circuits	Quantity		2											
Refrigerant charge	Per circuit		kg	64.0	73.0	81.0	91.0	107.0	112.5	124.0					
		TCO ₂ eq	91.5	104.4	115.8	130.1	153.0	160.9	177.3						
Piping connections	Evaporator water inlet/outlet (OD)			DN150PN16(168.3mm)			DN200PN16(219.1mm)			DN250PN16(273mm)					
Unit	Maximum starting current		A	598	611	648	912	960	1,016	1,059	1,072				
	Nominal running current (RLA)	Cooling	A	411	439	473	526	580	647	645	717	738	800	862	
	Maximum running current		A	462	493	542	585	649	708	783	847	901	954		
Power supply	Phase/Frequency/Voltage		Hz/V	3~/50/400											

(1) Cooling: entering evaporator water temp. 16°C; leaving evaporator water temp. 10°C; ambient air temp. 35°C; full load operation. (2) Data is calculated at ambient air temperature 5°C, inlet water temperature 16°C.



EWAD-TZ screw inverter chiller High efficiency in comfort and process cooling

Why choose EWAD-TZ?

Over 1,000 sites around the world with screw chillers installed is demonstrating that we will never stop developing the most advanced technology with highest quality level to offer the best chiller experience to our customers.

Benefits for the installer

- › Factory leak-tested and pre-charged
- › High serviceability
- › User-friendly smart controls which can be integrated easily with building management systems

Benefits for the consultant

- › Multiple options available, e.g. rapid restart, variable speed water pumps, smart energy meter, EC fans
- › Ideal for both new and retrofit projects: same footprints of non-inverter unit with higher efficiencies and performance

Benefits for the end user

- › Rapid payback of three years for comfort cooling applications
- › 50% reduction of energy consumption
- › Designed for sound-sensitive environments

High efficiencies both at full load and part load

- › Daikin compressor with in-built inverter and Variable Volume Ratio (VVR) for optimized efficiency
- › In-house developed software with dynamic condensing pressure management and innovative economizer control logic

Rapid return on investment

- › Payback of three years, compared to a non-inverter unit for comfort cooling applications
- › Less than one year for process cooling applications

Perfect comfort level

- › Infinitely variable load regulation
- › Precise leaving water temperature control thanks to stepless regulation

Compact design

- › More compact heat exchanger with superior efficiencies
- › Reduced electrical panel dimensions thanks to the inverter compressor mounted

Marketing tools

› Download the chiller selection software from the business portal

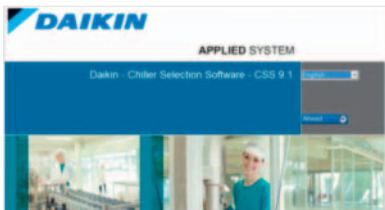

› EWAD-TZ movie: www.youtube.com/DaikinEurope



› Visit the mini-site: www.daikineurope.com/minisite/process-cooling-comfort-cooling-chiller-EWAD-TZ



Lowest sound levels

- › Down to 86 dB(A) sound power at full load and even lower at part load thanks to fans and compressors variable speed
- › Quiet compressor thanks to special acoustic executions
- › Unique Daikin fans design with reduced noise impact and vibrations

Unrivalled and proven reliability

- › Extensive testing in laboratories, Daikin factories and specific job sites
- › Reduced energy demand without compromising on reliability and performance

Extensive option list

- › Rapid restart after power failure
- › Variable speed water pumps
- › Integrated smart energy meter
- › EC fans

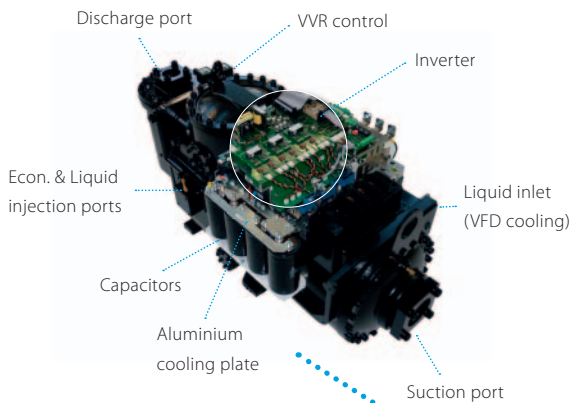

Air cooled screw inverter chiller, standard efficiency, standard/reduced sound

- › **Optimized energy efficiency both at full and part load conditions**
- › Stepless single-screw compressor
- › Advanced compressor technology featuring **integrated inverter** and **variable volume ratio (VVR)**
- › Compact design for small footprint and minimized installation space
- › Low operating sound levels are achieved by the latest compressor and fan design
- › One or two truly independent refrigerant circuits for outstanding reliability

Cooling only				EWAD-TZSS/SR																			
				170	205	235	270	320	365	370	415	465	500	540	590	640	710						
Cooling capacity	Nom.			kW																			
Power input	Cooling	Nom.		kW																			
Capacity control	Method	Stepless																					
	Minimum capacity			%																			
EER				33.3	28.6	33.3	28.6	25.0	22.2	15.4	14.3	16.7	15.4	14.3	13.3	12.5	11.1						
ESEER				2.73	2.83	2.90	2.79		2.74		2.85	2.83	2.80	2.82	2.72	2.73	2.66						
IPLV				4.62	4.61	4.75	4.80	4.82	4.93	4.65	4.81	4.71	4.84	4.83	4.85	4.76	4.92						
				5.80	5.44	6.02	5.84	5.94	5.78	5.86	6.18	6.16	6.09	6.07	6.09	6.13	6.04						
Dimensions	Unit	Height	mm	2,270								2,222											
		Width	mm	1,224				2,258															
		Depth	mm	3,461	4,361	5,261		3,218			4,117			5,015		5,917							
Weight (SS)	Unit			kg																			
	Operation weight			1,898	1,977	2,083	2,478	2,444	2,756	3,906	4,256	4,426	4,481	4,709	4,892	4,969	5,291						
Weight (SR)	Unit			kg																			
	Operation weight			1,915	2,077	2,183	2,504	2,596	2,806	3,995	4,426	4,590	4,645	4,873	5,162	5,231	5,553						
Water heat exchanger	Type	Plate heat exchanger																					
	Water flow rate	Cooling	Nom.	l/s																			
	Water pressure drop	Cooling	Total	kPa																			
	Water volume			8.1	9.8	11.0	12.8	15.1	17.4	17.5	19.7	22.1	23.9	25.6	28.2	30.6	34.0						
				25	24	29	33	26	27	36	50	33	37	43	36	47	57						
				17	24	26	39	50	89	170	164		270	262									
Air heat exchanger	Type	High efficiency fin and tube type																					
Compressor	Type	Inverter driven single screw compressor																					
	Quantity	1								2													
Fan	Type	Direct propeller																					
	Quantity			3	4	5	6	8	10	12													
	Air flow rate	Cooling	Nom.	l/s																			
	Speed			rpm																			
Sound power level (SS)	Cooling	Nom.		dBA																			
Sound power level (SR)	Cooling	Nom.		96	97	96	97	98	101	99	100	99	100	101	104								
Sound pressure level (SS)	Cooling	Nom.		89				90	92				93										
Sound pressure level (SR)	Cooling	Nom.		77				78	82	80	79	80		81	84								
Operation range	Air side	Cooling	Min.-Max.	°CDB																			
	Water side	Cooling	Min.-Max.	°CDB																			
				-18~47								-8~15											
Refrigerant	Type / GWP	R-134a / 1,430																					
	Circuits	Quantity		1								2											
Refrigerant charge	Per circuit			kg																			
				TCO ₂ eq																			
				29.0	35.0	39.0	46.0	54.0	62.0	31.0	35.0	39.5	42.5	45.5	50.0	54.5	60.5						
				41.5	50.1	55.8	65.8	77.2	88.7	44.3	50.1	56.5	60.8	65.1	71.5	77.9	86.5						
Piping connections	Evaporator water inlet/outlet (OD)	mm																					
Unit	Starting current	Max		88.9mm								114.3mm				139.7mm				168.3mm			
	Running current	Cooling	Nom.	A																			
				3																			
				105	121	132	159	191	218	223	241	273	294	314	359	385	434						
				120	142	156	185	215	246	259	284	313	339	370	402	430	491						
Power supply	Phase/Frequency/Voltage	Hz/V																					
		3~/50/400																					

Air cooled screw inverter chiller, high efficiency, standard/reduced sound



Cooling only				EWAD-TZXS/XR																									
Cooling capacity	Nom.			180	220	265	290	330	360	380	410	440	490	540	580	630	690												
Power input	Cooling	Nom.		kW	56.1	68.4	84.6	89.8	106	113	116	128	139	156	169	185	201	216											
Capacity control	Method	Stepless																											
	Minimum capacity			%	33.3	28.6	30.8	28.6	25.0	23.5	16.7	15.4	14.3	16.7	15.4	14.3	13.3	12.5											
EER					3.20	3.16	3.14	3.21	3.14	3.18	3.16	3.17	3.15	3.17	3.12	3.16													
ESEER					5.02	5.09	5.10	5.15	5.22	5.23	4.96	5.10	5.01	4.96	5.18	5.09	5.12	5.07											
IPLV					6.32	6.20	6.33	6.26	6.32	6.37	6.31	6.47	6.39	6.34	6.48	6.44	6.46	6.51											
Dimensions	Unit	Height	mm	2,270								2,222																	
		Width	mm	1,224								2,258																	
		Depth	mm	4,361	5,261	3,218	4,117				5,015				5,917				6,817										
Weight (XS)	Unit			kg	2,060	2,304	2,434	2,582	2,986	3,039	4,247	4,321	4,704	4,706	4,882	5,185	5,275	5,588											
	Operation weight			kg	2,081	2,404	2,586	2,734	3,035	3,088	4,417	4,479	4,864	5,152	5,455	5,537	5,843												
Weight (XR)	Unit			kg	2,158	2,402	2,532	2,679	3,084	3,136	4,442	4,516	4,901	5,077	5,381	5,471	5,783												
	Operation weight			kg	2,178	2,502	2,684	2,831	3,133	3,186	4,612	4,674	5,059	5,347	5,651	5,733	6,038												
Water heat exchanger	Type	Plate heat exchanger																											
	Water flow rate	Cooling	Nom.	l/s	8.6	10.4	12.7	13.8	15.9	17.2	17.5	19.5	21.1	23.5	25.7	27.6	30.1	32.7											
		Water pressure drop	Cooling	Total	kPa	24	25	19	22	23	26	40	41	48	56	30	34	44	57										
	Water volume			l	20	24	39	50	170	158	270				262	255													
Air heat exchanger	Type	High efficiency fin and tube type																											
Compressor	Type	Inverter driven single screw compressor																											
	Quantity	1								2																			
Fan	Type	Direct propeller																											
	Quantity	4				5				6				8				10				12				14			
	Air flow rate	Nom.	l/s	16,015	20,665	20,019	24,023	33,064	32,030	33,064	32,030	41,330	40,038	49,597	48,046	56,053													
	Speed	rpm	700																										
Sound power level (XS)	Cooling	Nom.	dBA	96	97	96	97	98	99				100	99	101														
	Sound power level (XR)	Cooling	Nom.	dBA	89				91	92				93				94											
Sound pressure level (XS)	Cooling	Nom.	dBA	77				78	80	79	80				79	80													
	Sound pressure level (XR)	Cooling	Nom.	dBA	69	70	69	70	71	72								73											
Operation range	Air side	Cooling	Min.-Max.	°CDB	-18~-49																								
	Water side	Cooling	Min.-Max.	°CDB	-8~-15																								
Refrigerant	Type / GWP	R-134a / 1,430																											
	Circuits	Quantity	1								2																		
Refrigerant charge	Per circuit			kg	31.0	37.0	45.0	49.0	57.0	61.0	31.0	34.5	37.5	42.0	45.5	49.0	53.5	58.0											
		TCO ₂ eq	44.3	52.9	64.4	70.1	81.5	87.2	44.3	49.3	53.6	60.1	65.1	70.1	76.5	82.9													
Piping connections	Evaporator water inlet/outlet (OD)			88.9mm								139.7mm				168.3mm													
	Unit	Starting current	Max	A	3																								
		Running current	Cooling	Nom.	A	97	116	142	151	179	190	199	217	235	262	284	310	338	361										
Power supply	Phase/Frequency/Voltage			Hz/V	3~/50/400																								

Air cooled screw inverter chiller, premium efficiency, standard/reduced sound

- › Premium energy efficiency both at full and part load conditions
- › Stepless single-screw compressor
- › Optimised for use with R-134a
- › Advanced compressor technology featuring **integrated inverter** and **variable volume ratio (VVR)**
- › Compact design for small footprint and minimized installation space
- › Low operating sound levels are achieved by the latest compressor and fan design
- › One or two truly independent refrigerant circuits for outstanding reliability



Cooling only				EWAD-TZPS/PR																																								
Cooling capacity	Nom.			kW																																								
Power input	Cooling	Nom.		kW																																								
Capacity control	Method			Stepless																																								
	Minimum capacity			%																																								
EER																																												
ESEER																																												
IPLV																																												
Dimensions	Unit	Height		mm																																								
		Width		mm																																								
		Depth		mm																																								
Weight (PS)	Unit				kg																																							
	Operation weight																																											
Weight (PR)	Unit				kg																																							
	Operation weight																																											
Water heat exchanger	Type			Plate heat exchanger						Single pass shell & tube																																		
	Water flow rate	Cooling	Nom.	l/s			l/s			l/s			l/s																															
	Water pressure drop	Cooling	Total	kPa			kPa			kPa			kPa																															
	Water volume			l			l			l			l																															
Air heat exchanger	Type			High efficiency fin and tube type																																								
Compressor	Type			Inverter driven single screw compressor																																								
	Quantity			1						2																																		
Fan	Type			Direct propeller																																								
	Quantity			6			8			10			12			14																												
	Air flow rate	Cooling	Nom.	l/s			l/s			l/s			l/s																															
	Speed			rpm																																								
Sound power level (PS)	Cooling	Nom.		96						99						100																												
				dBA																																								
Sound pressure level (PS)	Cooling	Nom.		77			76			77			79			78			79																									
				dBA																																								
Operation range	Air side	Cooling	Min.-Max.	°CDB																																								
				-18~-51																																								
Refrigerant	Water side	Cooling	Min.-Max.	°CDB																																								
				-8~-15																																								
Refrigerant	Type / GWP			R-134a / 1,430																																								
	Circuits	Quantity		1						2																																		
Refrigerant charge	Per circuit			kg																																								
				TCO ₂ eq																																								
Piping connections	Evaporator water inlet/outlet (OD)			88.9mm						139.7mm			168.3mm																															
	Unit	Starting current		A																																								
		Running current	Cooling	Nom.	87			105			113			125			137			153			168			180			201			215			238			269			290			321
			A																																									
Power supply	Phase/Frequency/Voltage			Hz/V																																								
				3~/50/400																																								



Air cooled mini inverter heat pump

- › Inverter technology to ensure low sound values and **leader-of-class ESEER**
- › Wide operating range
- › Easy 'plug and play' installation
- › Single phase power supply and low starting currents make the unit **ideal for residential applications**
- › Built-in hydronic module: no buffer tank required and a standard pump and main switch are included



Heating & Cooling		EWYQ-ADVP			005	006	007		
Cooling capacity	Nom.				kW	5.3 (1)	6.1 (1)	7.2 (1)	
Heating capacity	Nom.				kW	6.02 (2) / 5.57 (3)	6.72 (2) / 6.27 (3)	8.18 (2) / 7.67(3)	
Power input	Cooling	Nom.				kW	1.94 (1)	2.40 (1)	3.00 (1)
	Heating	Nom.				kW	1.65 (2) / 2.02 (3)	1.89 (2) / 2.29 (3)	2.41 (2) / 2.88(3)
Capacity control	Method				Inverter controlled				
EER					2.72 (1)	2.53 (1)	2.39 (1)		
COP					3.65 (2) / 2.76 (3)	3.58 (2) / 2.74 (3)	3.39 (2) / 2.66 (3)		
Space heating	Average climate water outlet 35°C	General	ηs (Seasonal space heating efficiency) SCOP	%	133			134	
					3.39			3.40	3.41
					Seasonal space heating eff. class			A+	
Dimensions	Unit	Height				mm	805		
		Width				mm	1,190		
		Depth				mm	360		
Weight	Unit				kg	100			
		Operation weight			kg	104			
Water heat exchanger	Type				Braze plate				
	Water flow rate	Cooling	Nom.				l/min	15	17
Heating		Nom.				l/min	18	20	24
Air heat exchanger	Type				Tube type				
Hydraulic components	Expansion vessel Volume				l	6			
Compressor	Type				Hermetically sealed swing compressor				
	Quantity				1				
Fan	Type				Propeller fan				
	Quantity				1				
Sound power level	Cooling	Nom.				dBA	62	63	
Sound pressure level	Cooling	Nom.				dBA	48	50	
	Heating	Nom.				dBA	48	49	
Operation range	Air side	Cooling	Min.~Max.				°CDB	10~43	
		Heating	Min.~Max.				°CDB	-15~25	
	Water side	Cooling	Min.~Max.				°CDB	5~20	
		Heating	Min.~Max.				°CDB	25~50	
Refrigerant	Type / GWP				R-410A / 2,087.5				
	Circuits	Quantity			1				
	Control				Inverter				
Refrigerant charge	Per circuit				kg	1.7			
					TCO ₂ eq	3.5			
Water circuit	Piping connections diameter				inch	1" MBSP			
Piping connections	Water heat exchanger drain				5/16 SAE flare				
Unit	Running current Max				A	19.0			
Power supply	Phase/Frequency/Voltage				Hz/V	1~/50/230			

(1) Tamb 35°C - LWE 7°C (DT=5°C) (2) DB/WB 7°C/6°C - LWC 35°C (DT=5°C) (3) DB/WB 7°C/6°C - LWC 45°C (Dt=5°C)

Air cooled mini inverter heat pump

- › Inverter technology to ensure low sound values and **leader-of-class ESEER**
- › Wide operating range
- › Built-in hydronic module: no buffer tank required and a standard pump and main switch are included
- › Easy 'plug and play' installation
- › Single phase power supply for residential applications, three phase power supply model available for light commercial applications



Heating & Cooling		EWYQ		009ACV3	010ACV3	011ACV3	009ACW1	011ACW1	013ACW1					
Cooling capacity	Nom.	kW		12.2 (1)/ 8.60 (2)	13.6 (1)/ 9.60 (2)	15.7 (1)/ 11.1 (2)	12.9 (1)/ 9.10 (2)	15.7 (1)/ 11.1 (2)	17.0 (1)/ 13.3 (2)					
Heating capacity	Nom.	kW		10.2 (1)/ 9.90 (2)	11.7 (1)/ 11.4 (2)	13.8 (1)/ 12.9 (2)	11.20 (1)/ 10.90 (2)	13.2 (1)/ 12.4 (2)	14.8 (1)/ 13.9 (2)					
Power input	Cooling	Nom.	kW		2.85 (1)/ 2.83 (2)	3.41 (1)/ 3.28 (2)	4.13 (1)/ 3.90 (2)	3.08 (1)/ 3.05 (2)	4.13 (1)/ 3.90 (2)	5.52 (1)/ 5.18 (2)				
	Heating	Nom.	kW		2.43 (1)/ 2.99 (2)	2.81 (1)/ 3.46 (2)	3.20 (1)/ 3.94 (2)	2.69 (1)/ 3.31 (2)	3.07 (1)/ 3.78 (2)	3.47 (1)/ 4.27 (2)				
Capacity control	Method		Inverter controlled											
EER			4.27 (1)/ 3.05 (2)		4.00 (1)/ 2.93 (2)	3.79 (1)/ 2.85 (2)	4.19 (1)/ 2.99 (2)	3.79 (1)/ 2.85 (2)	3.08 (1)/ 2.57 (2)					
ESEER			4.31		4.30	4.33	4.43	4.44	4.36					
COP			4.19 (1)/ 3.30 (2)		4.17 (1)/ 3.29 (2)	4.30 (1)/ 3.27 (2)	4.17 (1)/ 3.28 (2)	4.31 (1)/ 3.27 (2)	4.28 (1)/ 3.25 (2)					
Space heating	Average climate water outlet 35°C	General	ηs (Seasonal space heating efficiency)	%	126					131	134	126	134	130
					SCOP	3.22					3.34	3.41	3.22	3.41
			Seasonal space heating eff. class			A+								
Dimensions	Unit	Height		mm		1,435								
		Width		mm		1,420								
		Depth		mm		382								
Weight	Unit			kg		180								
Water heat exchanger	Type		Braze plate											
	Quantity		1											
	Water flow rate	Heating	Nom.	l/min		28.3	32.6	36.9	31.2	35.5	39.8			
Water volume				l		1.01								
Air heat exchanger	Type		Hi-XSS											
Pump Standard	Nominal ESP unit	Cooling	kPa		60.5	57.8	53.2	59.2	53.2	40.9 / 45.6				
		Heating	kPa		57.1	52.5	47.3	54.1	49.1	36.6 / 43.5				
Hydraulic components	Expansion vessel Volume		l		10									
Compressor	Type		Hermetically sealed scroll compressor											
	Quantity		1											
Fan	Type		Propeller fan											
	Quantity		2											
	Air flow rate	Cooling	Nom.	m³/min		96.0	100	97.0	-					
		Heating	Nom.	m³/min		90.0		-						
Fan motor	Speed	Cooling	Nom.	rpm		780								
		Heating	Nom.	rpm		760								
		Steps				8								
Sound power level	Cooling	Nom.	dBA		64		64		66					
	Heating	Nom.	dBA		60	64	60	60						
Sound pressure level	Cooling	Nom.	dBA		50									
	Heating	Nom.	dBA		50									
	Night quiet mode	Cooling	dBA		45		45		46					
		Heating	dBA		42		42		43					
Operation range	Air side	Cooling	Min.~Max.	°CDB		10~46								
		Heating	Min.~Max.	°CDB		-15~35								
	Water side	Cooling	Min.~Max.	°CDB		5~20								
		Heating	Min.~Max.	°CDB		30~50								
Refrigerant	Type/GWP			R-410A / 2,087.5										
	Circuits	Quantity		1										
	Control			Electronic expansion valve										
Refrigerant charge	Per circuit		kg		2.95									
			TCO ₂ eq		6.16									
Water circuit	Piping		inch		5/4"									
	Piping connections diameter		inch		G 5/4" (female)									
Power supply	Phase/Frequency/Voltage		Hz/V		1~/50/230			3N~/50/400						

(1) Underfloor program: cooling Ta 35°C - LWE 18°C (Dt: 5°C); heating Ta DB/WB 7°C/6°C - LWC 35°C (Dt: 5°C) (2) Fan coil program: cooling Ta 35°C - LWE 7°C (Dt: 5°C); heating Ta DB/WB 7°C/6°C - LWC 45°C (Dt: 5°C)

Air cooled scroll inverter heat pump

- › High efficiency with **leader-of-class ESEER**
- › Minimal starting currents and short payback times
- › No buffertank required for standard applications
- › **Large operation range** (ambient temperature up to 43°C)
- › A modbus gateway (RTD-W) can be installed per unit in order allow the control and monitoring by a Daikin controller or a third-party BMS, which will increase further the efficiency of the system
- › All systems that are connected with RTD-W can be controlled and **monitored centrally** with the master/slave control kit: the sequencing controller EKCC-W



Heating & Cooling					EWYQ-BAWN/BAWP	016	021	025	032	040	050	064
Cooling capacity	Nom.			kW	17.4(1)/16.6(2)	21.7(1)/20.7(2)	25.8(1)/24.7(2)	32.3(1)/30.9(2)	43.4(1)/41.5(2)	51.8(1)/49.7(2)	64.5(1)/62.3(2)	
Heating capacity	Nom.			kW	16.2(1)/17.00(2)	20.3(1)/21.30(2)	24.6(1)/25.70(2)	30.7(1)/32.10(2)	40.6(1)/42.50(2)	49.0(1)/51.10(2)	61.5(1)/63.70(2)	
Power input	Cooling	Nom.	kW		5.60(1)/5.80(2)	7.25(1)/7.59(2)	9.29(1)/9.74(2)	13.0(1)/13.5(2)	14.7(1)/15.4(2)	18.8(1)/19.7(2)	26.4(1)/27.4(2)	
		Nom.	kW		5.53(1)/5.73(2)	7.10(1)/7.44(2)	8.91(1)/9.36(2)	10.6(1)/11.1(2)	14.0(1)/14.7(2)	17.6(1)/18.5(2)	20.7(1)/21.7(2)	
Capacity control	Method		Inverter controlled									
	Minimum capacity		25									
EER					3.11(1)/2.86(2)	2.99(1)/2.73(2)	2.78(1)/2.54(2)	2.48(1)/2.29(2)	2.95(1)/2.69(2)	2.76(1)/2.52(2)	2.44(1)/2.27(2)	
ESEER					4.33(1)/4.21(2)	4.08(1)/4.18(2)	3.85(1)/4.04(2)	3.39(1)/3.62(2)	4.19(1)/4.24(2)	3.96(1)/4.12(2)	3.64(1)/3.78(2)	
COP					2.93(1)/2.97(2)	2.86(1)/2.86(2)	2.76(1)/2.75(2)	2.90(1)/2.89(2)		2.78(1)/2.76(2)	2.97(1)/2.94(2)	
Space heating	Average climate water outlet 35°C	General	ηs (Seasonal space heating efficiency)	%	130(1)/133(2)	126(1)/126(2)	130(1)/121(2)	120(1)/119(2)	126(1)/126(2)	138(1)/121(2)	121(1)/119(2)	
					SCOP	3.33(1)/3.39(2)	3.22(1)/3.22(2)	3.32(1)/3.09(2)	3.08(1)/3.06(2)	3.22(1)/3.21(2)	3.53(1)/3.08(2)	3.09(1)/3.04(2)
				Seasonal space heating eff. class	A+(1)/A+(2)		A+(1)/A(2)	A(1)/A(2)	A+(1)/A+(2)	A+(1)/A(2)	A(1)/A(2)	
Dimensions	Unit	Height		mm	1,684							
		Width		mm	1,370		1,680		2,360		2,980	
		Depth		mm	774				780			
Weight	Unit			kg	264	317	397	571	730			
		Operation weight		kg	267	320	401	577	738			
Water heat exchanger	Type		Brazed plate									
	Water flow rate	Cooling	Nom.	l/min	50.0	62.0	74.0	93.0	124	148	185	
		Heating	Nom.	l/min	46.0	58.0	71.0	88.0	116	140	176	
	Water pressure drop	Cooling	Total	kPa	20	30	42	30	42	30		
Water volume				l	1.90		2.90	3.80		5.70		
Air heat exchanger	Type		Hi-XSS									
Compressor	Type		Hermetically sealed scroll compressor									
	Quantity		1		2		3		4		6	
Fan	Type		Axial									
	Quantity		1		2		4		4			
	Air flow rate	Cooling	Nom.	m³/min	171	185	233	370	466			
Heating		Nom.	m³/min	171	185	233	370	466				
Sound power level	Cooling	Nom.	dBA		78.0		80.0	81.0		83.0		
Operation range	Air side	Cooling	Min.~Max.	°CDB	-5~-43							
		Heating	Min.~Max.	°CDB	-15~-35							
	Water side	Cooling	Min.~Max.	°CDB	-10~-20							
		Heating	Min.~Max.	°CDB	25~50							
Refrigerant	Type / GWP		R-410A / 2,087.5									
	Circuits	Quantity		1								
	Control		Electronic expansion valve									
Refrigerant charge	Per circuit		kg	7.6		9.6	15.2	19.2				
			TCO ₂ eq	15.9		20.0	31.7	40.1				
Water circuit	Piping		1-1/4"									
	Piping connections diameter		1-1/4" (female)				1-1/2"					
Unit	Starting current	Max	A		0.00	77.7	78.7	88.7	99.8	102	121	
		Running current	Max	A		22.2	25.3	26.4	35.2	47.4	49.6	67.2
Power supply	Phase/Frequency/Voltage		Hz/V		3N~/50/400							

(1) EWYQ-BAWN: Version without pump (2) EWYQ-BAWP: Version with pump

Air cooled scroll inverter heat pump, split version

- › **Hydronic module for indoor installation** eliminating the need for glycol
- › **Ideal for colder climates** as the lack of glycol will allow for high efficiencies
- › Compact dimensions and limited pipework allow for **installation in very restricted spaces**
- › Easy transportation as separate units will fit in an elevator



Heating & Cooling				SEHVX20AAW/ SERHQ020AAW1	SEHVX32AAW/ SERHQ032AAW1	SEHVX40AAW/ SERHQ020AAW1+SERHQ020AAW1	SEHVX64AAW/ SERHQ032AAW1+SERHQ032AAW1	
Cooling capacity	Nom.		kW	20.7	30.9	41.5	62.3	
Heating capacity	Nom.		kW	21.3 (1)/ 21.3 (2)	32.1 (1)/ 32.1 (2)	42.5 (1)/ 42.5 (2)	63.7 (1)/ 63.7(2)	
Power input	Cooling	Nom.	kW	7.59	13.5	15.4	27.4	
	Heating	Nom.	kW	6.12 (1)/ 7.44 (2)	8.72 (1)/ 11.1 (2)	12.0 (1)/ 14.7 (2)	16.9 (1)/ 21.7 (2)	
EER				2.73	2.29	2.69	2.27	
COP				3.48 (1)/2.86 (2)	3.68 (1)/ 2.89 (2)	3.54 (1)/ 2.89 (2)	3.77 (1)/ 2.94 (2)	
Space heating	Average climate water outlet 35°C	General	SCOP	3.22	3.06	3.22	3.05	
			ηs (Seasonal space heating efficiency)	%	126	119	126	120
			Seasonal space heating eff. class		A+	A	A+	A
Unit for indoor installation				SEHVX-AAW	SEHVX20AAW	SEHVX32AAW	SEHVX40AAW	SEHVX64AAW
Dimensions	Unit	Height	mm	1,573				
		Width	mm	766				
		Depth	mm	396				
Weight	Unit		kg	60	62	64	66	
	Packed unit		kg	70	72	74	76	
Sound power level	Nom.			63		66		
Operation range	Heating	Ambient	Min.-Max. °C	-15~35				
		Water side	Min.-Max. °C	25~50				
	Indoor installation	Ambient	Min. °CDB	5				
			Max. °CDB	35				
Cooling	Ambient	Min.-Max. °CDB	-5~43					
	Water side	Min.-Max. °C	5~20					
Refrigerant	Type / GWP			R-410A / 2,087.5				
	Circuits	Quantity		1				
	Control			Electronic expansion valve				
Water circuit	Piping connections diameter		inch	G 1"1/4 (female)		G 2" (female)		
	Piping		inch	1-1/4"		1-1/2"		
	Water pressure drop	Cooling	Nom. kPa	176	151	231	141	
		Heating	Nom. kPa	174	149	229	139	
Total water volume			l	3.2	4.2	5.8	7.7	
Water side Heat exchanger	Type			Braze plate				
	Water volume		l	1.9	2.9	3.8	5.7	
	Water flow rate	Heating	Nom. l/min	61	92	122	183	
		Cooling	Nom. l/min	59	89	119	179	
Current	Maximum	Cooling	A	5.54	5.64	7.24		
	running current	Heating	A	5.54	5.64	7.24		
Power supply	Phase/Frequency/Voltage		Hz/V	3N~/50/400				
Outdoor Unit				SERHQ-AAW1	SERHQ020AAW1	SERHQ032AAW1		
Dimensions	Unit	Height	mm	1,680				
		Width	mm	930		1,240		
		Depth	mm	765				
Weight	Unit		kg	240.00		316.00		
	Packed unit		kg	273.00		355.95		
Compressor	Quantity			2		3		
	Type			Hermetically sealed scroll compressor				
Fan	Type			Propeller fan				
	Quantity			1		2		
	Air flow rate	Cooling	Nom. m³/min	185		233		
		Heating	Nom. m³/min	185		233		

(1) Heating Ta DB/WB 7/6°C - LWC 35°C (DT=5°C) (2) Heating Ta DB/WB 7/6°C - LWC 45°C

Air cooled multi-scroll heat pump, high efficiency, standard sound

- › Single refrigerant circuit (2 scroll compressors) with single evaporator
- › Compact design to allow easy indoor installation or retrofit operations
- › Partial and total heat recovery option available
- › Stainless steel plate heat exchanger

Heating & Cooling		EWYQ-G-XS		075	085	100	110	120	140	160		
Cooling capacity	Nom.			kW	77.8	88.1	101	117	127	147	165	
Heating capacity	Nom.			kW	82.2	91.2	110	127	138	156	170	
Power input	Cooling	Nom.			kW	27.0	31.5	36.0	39.5	44.7	57.8	
	Heating	Nom.			kW	26	29	34	39	43	50	54
Capacity control	Method			Step								
	Minimum capacity			%	50	44	50	44	50	43	50	
EER					2.88	2.80	2.81	2.97	2.84	2.92	2.85	
ESEER					3.90	3.94	3.97	4.03	3.92	3.96		
COP					3.14	3.12	3.24	3.25	3.20	3.11	3.13	
IPLV					4.40	4.47	4.40	4.49	4.40	4.50		
Space heating	Average climate water outlet 35°C	General	ηs (Seasonal space heating efficiency)	%	131	129	142	140	142	138	140	
					SCOP	3.35	3.31	3.62	3.58	3.63	3.53	3.58
Dimensions	Unit	Height			mm	1,800						
		Width			mm	1,195						
		Depth			mm	2,826		3,426		4,026		
Weight	Unit			kg	850	912	1,077	1,183	1,213	1,333	1,394	
		Operation weight		kg	858	921	1,088	1,194	1,224	1,344	1,411	
Water heat exchanger	Type			Brazen plate								
	Water flow rate	Cooling	Nom.	l/s	3.7	4.2	4.8	5.6	6.1	7.0	7.9	
		Heating	Nom.	l/s	4.0	4.4	5.3	6.1	6.7	7.5	8.2	
	Water pressure drop	Cooling	Nom.	kPa	8.40	8.30	8.70	11.6	13.7	18.2	19.9	
		Heating	Nom.	kPa	9.50	9.10	11.20	14.40	17.20	21.70	22.50	
Water volume				l	8.10	9.40	10.8			16.7		
Air heat exchanger	Type			High efficiency fin and tube type with integral subcooler								
Compressor	Type			Scroll compressor								
	Quantity			2								
Fan	Type			Direct propeller								
	Quantity			6		8		10				
	Air flow rate	Nom.		l/s	10,042	9,861	13,148		16,435			
	Speed			rpm	1,360							
Sound power level	Cooling	Nom.		dBA	84	85	87	89				
Sound pressure level	Cooling	Nom.		dBA	66	68	70	71				
Operation range	Air side	Cooling	Min.-Max.	°CDB	-10~45							
	Water side	Cooling	Min.-Max.	°CDB	-10~15							
Refrigerant	Type / GWP			R-410A / 2,087.5								
	Circuits	Quantity		1								
Refrigerant charge	Per circuit			kg	15.0	18.0	23.0		30.0			
				TCO ₂ eq	31.3	37.6	48.0	62.6				
Piping connections	Evaporator water inlet/outlet (OD)			2" 1/2								
Unit	Starting current			Max	A	210	261	267	316	323	363	377
	Running current	Cooling	Nom.		A	52	56	60	69	76	88	95
		Max		A	66	72	78	87	95	111	125	
Power supply	Phase/Frequency/Voltage			Hz/V	3~/50/400							

Air cooled multi-scroll heat pump, high efficiency, reduced sound

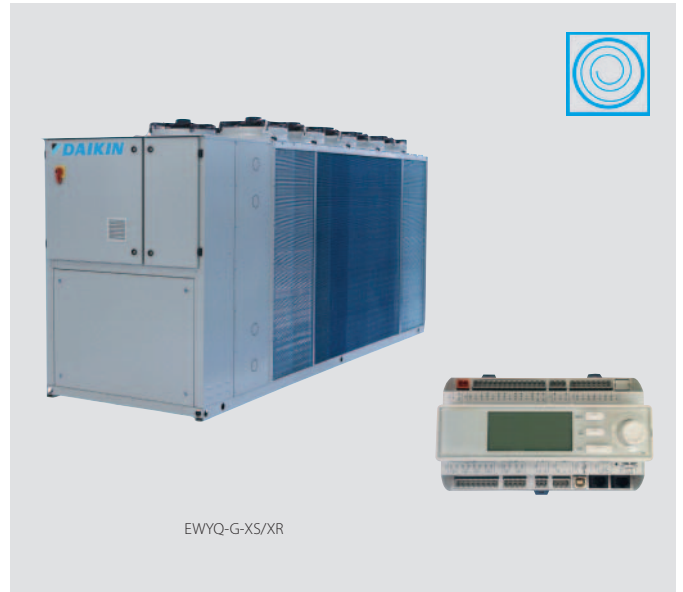

Heating & Cooling					EWYQ-G-XR		075	085	100	110	120	140	160
Cooling capacity	Nom.			kW	75.2	84.5	95.0	111	120	139	155		
Heating capacity	Nom.			kW	82.2	91.2	110	127	138	156	170		
Power input	Cooling	Nom.	kW		27.7	32.7	38.6	41.5	47.4	52.8	61.5		
	Heating	Nom.	kW		26	29	34	39	43	50	54		
Capacity control	Method			Step									
	Minimum capacity			%	50	44	50	44	50	43	50		
EER					2.71	2.59	2.46	2.68	2.52	2.64	2.51		
ESEER					3.85	3.90	3.79	3.92	3.76	3.86	3.79		
COP					3.14	3.12	3.24	3.25	3.20	3.11	3.13		
IPLV					4.35	4.41	4.29	4.42	4.27	4.40	4.35		
Space heating	Average climate water outlet 35°C	General	ηs (Seasonal space heating efficiency)	%	131	129	142	140	142	138	140		
					SCOP	3.35	3.31	3.62	3.58	3.63	3.53	3.58	
Dimensions	Unit	Height		mm	1,800								
		Width		mm	1,195								
		Depth		mm	2,826		3,426		4,026				
Weight	Unit	Operation weight		kg	880	942	1,107	1,213	1,243	1,363	1,424		
				kg	888	951	1,118	1,224	1,254	1,374	1,441		
Water heat exchanger	Type		Brazed plate										
	Water flow rate	Cooling	Nom.	l/s	3.6	4.0	4.5	5.3	5.7	6.7	7.4		
		Heating	Nom.	l/s	4.0	4.4	5.3	6.1	6.7	7.5	8.2		
	Water pressure drop	Cooling	Nom.	kPa	7.90	7.70	7.60	10.5	12.1	16.4	17.5		
		Heating	Nom.	kPa	9.50	9.10	11.2	14.4	17.2	21.7	22.5		
Water volume				l	8.10	9.40	10.8				16.7		
Air heat exchanger	Type		High efficiency fin and tube type with integral subcooler										
Compressor	Type		Scroll compressor										
	Quantity		2										
Fan	Type		Direct propeller										
	Quantity		6		8		10						
	Air flow rate	Nom.	l/s	7,859	7,101	9,468	11,835						
Speed				rpm	1,108								
Sound power level	Cooling	Nom.	dBA		80	82	84	86					
Sound pressure level	Cooling	Nom.	dBA		62	65	66	68		67			
Operation range	Air side	Cooling	Min.-Max.	°CDB	-10~45								
	Water side	Cooling	Min.-Max.	°CDB	-10~15								
Refrigerant	Type / GWP		R-410A / 2,087.5										
	Circuits	Quantity		1									
Refrigerant charge	Per circuit		kg		210	261	267	316	323	363	377		
			TCO ₂ eq		31.3		37.6	48.0		62.6			
Unit	Starting current		Max		A	210	261	267	316	323.0	363	377	
	Running current	Cooling	Nom.	A	54	60	65	71	80	90	103		
		Max		A	66	72	78	87	95	111	125		
Power supply	Phase/Frequency/Voltage				Hz/V	3~/50/400							

Air cooled multi-scroll heat pump, high efficiency, standard/low sound

› **Class A efficiency in heating mode**

- › Extended operation range: ambient temperatures from -10°C up to +46°C in cooling mode and down to -17°C in heating mode
- › 2 truly independent refrigerant circuits
- › Reduced footprint thanks to the **V-shaped frame** (EWYQ160-230F-XS/XL & EWYQ160-220F-XR)
- › Reliable and efficient scroll compressors with **high EER values**
- › Chiller series design entirely based on new European directives (EN14511, EN14825)
- › Top serviceability level thanks to reduced weight, compact footprint and optimized components accessibility

- › The unit can be equipped with a hydraulic module optimizing installation time, space and cost
- › Wide range of available options and accessories
- › Inverter fans management for enhanced part load efficiencies
- › Nordic kit option to improve the chiller working conditions in heating mode
- › MicroTech III controller with superior control logic and easy interface

Heating & Cooling				EWYQ-F-XS/XL													
				160	190	210	230	310	340	380	400	430	510	570	630		
Cooling capacity	Nom.	kW		164	184	205	231	304	335	376	401	427	502	565	624		
Heating capacity	Nom.	kW		173	197	227	254	329	362	404	429	463	535	607	674		
Power input	Cooling	Nom.	kW	57.6	63.3	70.3	79.3	102	114	129	138	145	172	195	214		
	Heating	Nom.	kW	54.0	61.6	70.5	79.2	101	113	126	133	140	167	190	210		
Capacity control	Method			Step													
	Minimum capacity			25.0									17.0				
EER				2.84	2.91	2.92		2.99	2.93	2.91	2.90	2.94	2.92	2.90	2.91		
ESEER				3.73	3.89	3.81	3.71	4.07	4.19	3.99	3.96	4.14	4.20	3.98	4.06		
COP				3.20		3.22	3.21	3.24	3.21		3.23	3.30	3.21	3.20	3.21		
IPLV				4.45	4.47	4.55	4.38	4.56	4.61	4.38	4.50	4.70	4.71	4.56	4.74		
Space heating	Average climate water outlet 35°C	General	ηs (Seasonal space heating efficiency)	%	128	134	129		143	147							
					SCOP		3.28	3.42	3.31	3.30	3.64	3.75					
Dimensions	Unit	Height		2,270				2,220									
		Width		1,200				2,258									
		Depth		4,370		5,270		4,125			5,025		5,925		6,825		
		Weight (XS)		kg		1,430	1,850	2,300	2,350	2,900	2,910	2,920	3,730	3,750	4,250	4,280	4,670
Weight (XL)	Operation weight		kg		1,470	1,890	2,340	2,390	2,980	2,990	3,000	3,840	3,850	4,370	4,400	4,780	
	Weight (XL)		kg		1,520	1,940	2,400	2,440	3,060	3,070	3,080	3,890	3,900	4,400	4,440	4,820	
Water heat exchanger	Type			Plate heat exchanger													
	Water flow rate	Cooling	Nom.	l/s	7.8	8.8	9.8	11.1	14.6	16.0	18.0	19.2	20.4	24.0	27.1	29.9	
		Heating	Nom.	l/s	8.3	9.5	10.9	12.2	15.9	17.5	19.5	20.7	22.3	25.8	29.3	32.5	
	Water pressure drop	Cooling	Nom.	kPa	22	28	36	40	21	27	30	29	34	37	42	56	
		Heating	Nom.	kPa	25	32	43	50	25	31	37	33	40	43	50	66	
Water volume		l		18				44			60		70				
Air heat exchanger	Type			High efficiency fin and tube type with integral subcooler													
Compressor	Type			Scroll compressor													
	Quantity			4									6				
Fan	Type			Direct propeller													
	Quantity			4			5			8			10		12		14
	Air flow rate	Nom.		l/s	22,577	21,593	26,992		43,187			55,213	53,983	64,780		75,577	
	Speed		rpm		900												
Sound power level (XS)	Cooling	Nom.		dBA	92	94	95		97		98		99		100		
Sound power level (XL)	Cooling	Nom.		dBA	89	92	93		95			96		97		98	
Sound pressure level (XS)	Cooling	Nom.		dBA	72	74	75	76	77		78		79		80		
Sound pressure level (XL)	Cooling	Nom.		dBA	70	73		74	75			76		77			
Operation range	Air side	Cooling	Min.-Max.	°CDB	-10~-46												
		Heating	Min.-Max.	°CDB	-17~-20												
	Water side	Cooling	Min.-Max.	°CDB	-13~-15												
		Heating	Min.-Max.	°CDB	25~50												
Refrigerant	Type / GWP			R-410A / 2,087.5													
	Circuits			Quantity			2										
Refrigerant charge	Per circuit			kg	16.0	20.0	24.0	35.0	36.0	35.0	46.0	55.0	52.5	68.0			
				TCO ₂ eq	33.4	41.8	50.1	73.1	75.2	73.1	96.0	114.8	109.6	142.0			
Piping connections	Evaporator water inlet/outlet (OD)			2.5"				3"									
Unit	Starting current			Max	A	282	536	353	560	600	516	637	659	666	648	787	827
	Running current	Cooling	Nom.	A	115	140	128	162	193	205	235	251	257	307	353	384	
		Max		A	138	165	164	196	246	264	295	316	330	396	442	491	
Power supply	Phase/Frequency/Voltage			Hz/V	3~/50/400												

Air cooled multi-scroll heat pump, high efficiency, reduced sound



EWYQ-F-XS/XL/XR

MicroTech III

Heating & Cooling					EWYQ-F-XR																												
					160	180	200	220	300	330	360	390	420	490	550	610																	
Cooling capacity	Nom.				kW	158	178	199	223	296	326	363	389	415	487	546	606																
Heating capacity	Nom.				kW	173	197	227	254	329	362	404	429	463	535	607	674																
Power input	Cooling	Nom.			kW	56.2	62.3	68.4	77.9	97.4	111	127	134	141	167	191	210																
	Heating	Nom.			kW	54.0	61.6	70.5	79.2	101	113	126	133	140	167	190	210																
Capacity control	Method	Step																															
	Minimum capacity				%	25.0								17.0																			
EER						2.81	2.86	2.92	2.87	3.04	2.93	2.86	2.90	2.93	2.91	2.85	2.89																
ESEER						4.33	4.39	4.38	4.19	4.63	4.68	4.37	4.44	4.60	4.83	4.50	4.62																
COP						3.20		3.22	3.21	3.24	3.21		3.23	3.30	3.21	3.20	3.21																
IPLV						5.11	5.18	5.22	4.96	5.25	5.35	4.97	5.08	5.25	5.54	5.13	5.36																
Space heating	Average climate water outlet 35°C	General	ηs (Seasonal space heating efficiency)	%																													
							128		134		129		143		147		-																
					SCOP		3.28	3.42	3.31	3.30	3.64	3.75	-																				
Dimensions	Unit	Height				2,270				2,220																							
			Width				1,200				2,258																						
				Depth	4,370		5,270		4,125		5,025		5,925		6,825																		
Weight	Unit				1,520		1,940		2,400		2,440		3,060		3,070		3,080		3,890		3,900		4,400		4,440		4,820						
		Operation weight				1,570		1,980		2,440		2,480		3,130		3,150		3,160		3,990		4,010		4,520		4,550		4,940					
Water heat exchanger	Type	Plate heat exchanger																															
		Water flow rate	Cooling	Nom.	l/s				7.5		8.5		9.6		10.7		14.2		15.6		17.4		18.6		19.8		23.3		26.1		29.0		
				Heating	Nom.	l/s				8.3		9.5		10.9		12.2		15.9		17.5		19.5		20.7		22.3		25.8		29.3		32.5	
		Water pressure drop	Cooling	Nom.	kPa				20		26		34		38		20		25		28		27		32		35		39		53		
				Heating	Nom.	kPa				25		32		43		50		25		31		37		33		40		43		50		66	
Water volume				l				18				44		60		70																	
Air heat exchanger	High efficiency fin and tube type with integral subcooler																																
Compressor	Type	Scroll compressor																															
	Quantity	4												6																			
Fan	Type	Direct propeller																															
	Quantity	4				5				8				10				12				14											
	Air flow rate	Nom.			l/s				17,380		16,564		20,706		33,129		42,431		41,411		49,693		57,975										
Speed				rpm				700																									
Sound power level	Cooling	Nom.			dBA				83		84		86		88		89		90		92												
Sound pressure level	Cooling	Nom.			dBA				64		65		66		67		69		70		71												
Operation range	Air side	Cooling	Min.-Max.	°CDB				-10~46																									
			Heating	Min.-Max.	°CDB				-17~20																								
	Water side	Cooling	Min.-Max.	°CDB				-13~15																									
			Heating	Min.-Max.	°CDB				25~50																								
Refrigerant	Type / GWP	R-410A / 2,087.5																															
	Circuits	Quantity			2																												
Refrigerant charge	Per circuit				kg		16.0		18.0		20.0		24.0		35.0		36.0		35.0		46.0		55.0		68.0								
					TCO ₂ eq		33.4		37.6		41.8		50.1		73.1		75.2		73.1		96.0		114.8		142.0								
Piping connections	Evaporator water inlet/outlet (OD)				2.5"				3"																								
Unit	Starting current	Max			A				276		530		346		553		589		505		626		645		652		631		770		807		
		Running current	Cooling	Nom.			A				114		138		126		160		187		201		232		245		252		301		350		379
				Max	A			133		160		157		189		235		253		283		302		316		379		425		471			
Power supply	Phase/Frequency/Voltage				Hz/V				3~/50/400																								

Air cooled screw inverter heat pump, standard efficiency, standard sound

- › Ideal solution for **commercial comfort cooling and/or heating applications**
- › Optimum ESEER values
- › 2-3 truly independent refrigerant circuits
- › Low starting current
- › DX shell and tube evaporator – one pass refrigerant side to minimize pressure drops
- › Standard electronic expansion valve
- › Optimised defrost cycles
- › Partial and total heat recovery option available
- › Power factor up to 0.95
- › PID microprocessor control

Heating & Cooling				EWYD-BZSS																	
				250	270	290	320	340	370	380	410	440	460	510	520	580					
Cooling capacity	Nom.			kW	253	272	291	323	337	363	380	411	433	455	502	519	580				
Heating capacity	Nom.			kW	271	298	325	334	350	380	412	445	465	477	533	561	618				
Power input	Cooling	Nom.			kW	91.3	101	110	117	125	135	144	154	165	182	189	218				
	Heating	Nom.			kW	91.4	100	108	118	126	133	143	157	167	165	178	186	208			
Capacity control	Method			Stepless																	
	Minimum capacity			%	13.0									9.0							
EER					2.77	2.70	2.65	2.75	2.69	2.68	2.63	2.66	2.62	2.79	2.76	2.74	2.67				
ESEER					3.93	3.92	3.89	3.95	3.89	3.90	3.82	3.91	3.89	4.18	4.01		3.93				
COP					2.96	2.97	3.00	2.82	2.78	2.85	2.88	2.83	2.79	2.88	2.99	3.01	2.97				
IPLV					4.58	4.62		4.75	4.64	4.71	4.67	4.73	4.69	4.85	4.89	4.85	4.78				
Space heating	Average climate water outlet 35°C	General	η _s (Seasonal space heating efficiency)	%	125						-										
					SCOP	3.21		3.20		3.21		-									
Dimensions	Unit	Height		mm	2,335									2,280							
		Width		mm	2,254																
		Depth		mm	3,547			4,428			5,329			6,659							
Weight	Unit	Operation weight		kg	3,410	3,455	3,500	3,870	3,940	4,010	4,390	5,015	5,495	5,735							
		Weight		kg	3,550	3,595	3,640	4,010	4,068	4,138	4,518	5,255	5,724	5,964	5,953						
Water heat exchanger	Type			Single pass shell & tube																	
	Water flow rate	Cooling	Nom.	l/s	12.1	13.0	13.9	15.5	16.2	17.4	18.2	19.7	20.8	21.8	24.1	24.9	27.8				
		Heating	Nom.	l/s	13.1	14.4	15.7	16.1	16.9	18.3	19.8	21.4	22.4	23.0	25.6	27.0	29.7				
	Water pressure drop	Cooling	Nom.	kPa	40	46	44	50	55	60	65	74	80	47	85	91	61				
		Heating	Nom.	kPa	30	35	52	37	40	45	51	59	64	42	63	69	59				
Water volume				l	138			133			128			240		229		218			
Air heat exchanger	Type			High efficiency fin and tube type with integral subcooler																	
Compressor	Type			Single screw compressor																	
	Quantity			2									3								
Fan	Type			Direct propeller																	
	Quantity			6			8			10			12								
	Air flow rate	Nom.		l/s	31,729	31,422	31,115	42,306	42,337	41,487	52,882	63,458	62,640	61,652	62,231						
Speed				rpm	900																
Sound power level	Cooling	Nom.		dBA	101						102			104							
Sound pressure level	Cooling	Nom.		dBA	82						83			84							
Operation range	Air side	Cooling	Min.-Max.	°CDB	-10~45																
		Heating	Min.-Max.	°CDB	-10~20																
	Water side	Cooling	Min.-Max.	°CDB	-8~15																
		Heating	Min.-Max.	°CDB	35~55																
Refrigerant	Type / GWP			R-134a / 1,430																	
	Circuits			Quantity	2									3							
Refrigerant charge	Per circuit			kg	43.0	44.0	43.0	46.0	46.5	47.0	50.0	47.0			49.0						
				TCO ₂ eq	61.5	62.9	61.5	65.8	66.5	67.2	71.5	67.2			70.1						
Piping connections	Evaporator water inlet/outlet (OD)			139.7mm																	
Unit	Starting current			Max	150			181			204			224			238		245	300	323
	Running current	Cooling	Nom.	A	137	150	164	176	188	202	214	229	244	246	270	281	322				
		Max		A	211		212		254		288		316		336		329		398		432
Power supply	Phase/Frequency/Voltage			Hz/V	3~/50/400																

Air cooled screw inverter heat pump, standard efficiency, low sound



EWYD-BZSS/SL

MicroTech II

Heating & Cooling					EWYD-BZSL															
					250	270	290	320	330	360	370	400	430	450	490	510	570			
Cooling capacity	Nom.			kW	247	265	290	315	330	353	370	401	423	446	490	507	565			
Heating capacity	Nom.			kW	271	298	325	334	350	380	412	445	465	477	533	561	618			
Power input	Cooling	Nom.			kW	89.5	99.5	110	115	123	134	144	151	163	158	177	186	216		
		Heating	Nom.			kW	91.4	100	108	118	126	133	143	157	167	165	178	186	208	
Capacity control	Method			Stepless																
	Minimum capacity			%	13.0									9.0						
EER					2.76	2.66	2.62	2.75	2.68	2.64	2.57	2.66	2.59	2.83	2.77	2.73	2.61			
ESEER					4.06	4.04	4.03	4.17	4.09	4.04	4.01	4.06	4.02	4.18	4.16	4.10	3.98			
COP					2.96	2.97	3.00	2.82	2.78	2.85	2.88	2.83	2.79	2.88	2.99	3.01	2.97			
IPLV					4.90	4.96	4.91	5.17	5.08	5.12	5.06	5.22	5.13	5.07	5.03	4.99	4.90			
Space heating	Average climate water outlet 35°C	General	η _s (Seasonal space heating efficiency) SCOP	%	125						-									
					3.21	3.20	3.21	-												
Dimensions	Unit	Height		mm	2,335									2,280						
		Width		mm	2,254															
		Depth		mm	3,547			4,428			5,329			6,659						
Weight	Unit	Operation weight		kg	3,750	3,795	3,840	4,210	4,280	4,350	4,730	5,525	6,005	6,245						
		Type		kg	3,888	3,933	3,978	4,343	4,408	4,478	4,858	5,765	6,234	6,474	6,463					
Water heat exchanger	Type			Single pass shell & tube																
	Water flow rate	Cooling	Nom.	l/s	11.8	12.7	13.9	15.1	15.8	16.9	17.7	19.2	20.3	21.4	23.5	24.3	27.1			
			Heating	Nom.	l/s	13.1	14.4	15.7	16.1	16.9	18.3	19.8	21.4	22.4	23.0	25.6	27.0	29.7		
	Water pressure drop	Cooling	Nom.	kPa	38	44	42	48	53	57	62	71	77	45	82	87	58			
			Heating	Nom.	kPa	30	35	52	37	40	45	51	59	64	42	63	69	59		
Water volume			l	138			133			128			240		229		218			
Air heat exchanger	Type			High efficiency fin and tube type with integral subcooler																
Compressor	Type			Single screw compressor																
	Quantity			2									3							
Fan	Type			Direct propeller																
	Quantity			6			8			10			12							
	Air flow rate	Cooling	Nom.	l/s	24,432	24,264	24,095	32,576	32,628	32,127	40,720	48,863	48,415	47,732	48,191					
Speed				rpm	700															
Sound power level	Cooling	Nom.		dBA	94			95			97									
Sound pressure level	Cooling	Nom.		dBA	76						77									
Operation range	Air side	Cooling	Min.-Max.	°CDB	-10~45															
			Heating	Min.-Max.	°CDB	-10~20														
	Water side	Cooling	Min.-Max.	°CDB	-8~15															
			Heating	Min.-Max.	°CDB	35~55														
Refrigerant	Type / GWP			R-134a / 1,430																
	Circuits			Quantity	2									3						
Refrigerant charge	Per circuit			kg	43.0	44.0	43.0	46.0	46.5	47.0	50.0	47.0			49.0					
				TCO ₂ eq	61.5	62.9	61.5	65.8	66.5	67.2	71.5	67.2			70.1					
Piping connections	Evaporator water inlet/outlet (OD)			139.7mm																
Unit	Starting current			Max	A	145	146	176	199			217	231	234	288	311	305			
	Running current	Cooling	Nom.	A	134	148	163	171	184	199	212	224	240	238	263	275	319			
			Max	A	202	203	243	277			302	322	313	381	415	406				
Power supply	Phase/Frequency/Voltage			Hz/V	3~/50/400															

Air cooled screw condensing unit, standard efficiency, standard sound

- › One refrigerant circuit with single screw compressor
- › Compact design
- › Large operation range (ambient temperature down to -18°C)
- › Extensive option list (heat recovery option available)

Cooling only		ERAD-E-SS		120	140	170	200	220	250	310	370	440	490		
Cooling capacity	Nom.		kW	121	144	165	196	219	251	309	370	435	488		
Power input	Cooling	Nom.	kW	42.1	51.2	57.7	65.6	74.2	77.0	93.8	123	148	161		
Capacity control	Method	Stepless													
	Minimum capacity		%	25.0											
EER				2.88	2.82	2.86	2.99	2.95	3.27	3.30	3.02	2.95	3.02		
Dimensions	Unit	Height	mm	2,273						2,223					
		Width	mm	1,292						2,236					
		Depth	mm	2,165		3,065		3,965		3,070					
Weight	Unit		kg	1,584		1,741		1,936		2,679					
	Operation weight		kg	1,617		1,781		1,981		2,756					
Air heat exchanger	Type	High efficiency fin and tube type with integral subcooler													
Compressor	Type	Single screw compressor													
	Quantity	1													
Fan	Type	Direct propeller													
	Air flow rate	Nom.	l/s	10,924	10,576	16,386	15,865	21,848	21,153	32,772		31,729			
	Quantity			2		3		4		6					
	Speed	Cooling	Nom.	rpm											
				900											
Sound power level	Cooling	Nom.	dBA	92				93		94		95		96	
Sound pressure level	Cooling	Nom.	dBA	74				75		76		77		78	
Operation range	Saturated suction temp.		°C	-9~12											
	Condenser inlet temp.		°C	-18~48											
Refrigerant	Type / GWP	R-134a / 1,430													
	Circuits	Quantity		1											
Piping connections	Evaporator water inlet/outlet (OD)	76mm / 139.7mm													
Unit	Maximum starting current		A	151		195		288		330		410			
	Nominal running current (RLA)	Cooling	A	72	88	98	110	125	129	158	204	244	266		
	Maximum running current		A	86	103	119	132	157	164	198	242	284	298		
Power supply	Phase/Frequency/Voltage		Hz/V	3~/50/400											

Air cooled screw condensing unit, standard efficiency, low sound



Cooling only		ERAD-E-SL		120	140	160	190	210	240	300	350	410	460		
Cooling capacity	Nom.	kW		116	137	159	187	209	243	298	352	409	462		
Power input	Cooling	Nom. kW		42.4	52.5	57.7	66.3	73.9	78.1	91.9	122	150	167		
Capacity control	Method		Stepless												
	Minimum capacity		%		25.0										
EER			2.74	2.61	2.75	2.83	3.11	3.24	2.88	2.73	2.76				
Dimensions	Unit	Height	mm		2,273						2,223				
		Width	mm		1,292						2,236				
		Depth	mm		2,165		3,065		3,965		3,070				
Weight	Unit	kg		1,684		1,841		2,036		2,789					
	Operation weight		kg		1,717		1,881		2,081		2,886				
Air heat exchanger	Type		High efficiency fin and tube type with integral subcooler												
Compressor	Type		Single screw compressor												
	Quantity		1												
Fan	Type		Direct propeller												
	Air flow rate	Nom.	l/s		8,373	8,144	12,560	12,216	16,747	16,288	25,120	24,432			
	Quantity				2		3		4		6				
	Speed	Cooling	Nom. rpm		700										
Sound power level	Cooling	Nom. dBA		89		90		91		92		93			
Sound pressure level	Cooling	Nom. dBA		71				73				74			
Operation range	Saturated suction temp		°C		-9~12										
	Condenser inlet temp		°C		-18~48										
Refrigerant	Type / GWP		R-134a / 1,430												
	Circuits		Quantity		1										
Piping connections	Evaporator water inlet/outlet (OD)				76mm						139.7mm				
Unit	Maximum starting current		A		151		195		288		330		410		
	Nominal running current (RLA)	Cooling	A		73	90	98	112	125	131	155	204	249	275	
	Maximum running current		A		83	100	115	128	151	158	189	234	276	290	
Power supply	Phase/Frequency/Voltage		Hz/V		3~/50/400										

Water cooled screw chiller, standard efficiency, standard sound

- › All models are PED pressure vessel approved
- › 1 or 2 stepless single-screw compressors
- › One or two truly independent refrigerant circuits for outstanding reliability
- › Shell and tube heat exchanger
- › Optimised for use with **R-410A**
- › Standard electronic expansion valve
- › Compact design
- › Partial heat recovery available
- › MicroTech III controller with superior control logic and easy interface

Cooling only				EWQ-B-SS																			
				380	460	560	640	730	800	860	870	960	C10	C11	C12	C13	C14	C15	C16	C17	C19	C20	
Cooling capacity	Nom.			kW	379	462	560	635	724	793	859	868	956	1,003	1,050	1,181	1,251	1,320	1,452	1,595	1,754	1,896	2,055
Power input	Cooling	Nom.		kW	89.2	109	133	150	170	179	207	199	218	247	243	268	285	303	337	373	407	441	477
Capacity control	Method				Stepless																		
	Minimum capacity			%	12.5				25.0	12.5	25.0	12.5	25.0										
EER					4.24	4.21	4.22	4.25	4.42	4.15	4.36	4.38	4.07	4.32	4.41	4.38	4.35	4.31	4.28	4.31	4.30	4.31	4.31
ESEER					4.64	4.69	4.70	4.46	5.08	4.35	5.07	5.03	4.28	5.04	5.05	5.06	5.00	4.66	4.76	4.61	4.63	4.54	4.54
IPLV					5.57	5.62	5.63	5.32	5.58	5.15	5.75	5.92	5.08	5.90	5.93	5.85	5.46	5.44	5.34	5.38	5.32	5.32	5.32
Dimensions	Unit	Height		mm	1,849	2,001		1,848	2,158	1,848	2,158	1,851	2,378	2,455		2,495							
		Width		mm	1,140	1,276		1,314	1,350	1,327	1,350	1,314		1,350									
		Depth		mm	3,373	3,454		3,535	5,020	3,535	5,020	3,535	4,894	5,070		4,892		4,865					
Weight	Unit		kg	1,933	1,967	2,283	2,332	2,407	3,921	2,427	3,949	3,988	2,457	4,344	4,529	4,536	4,607	4,988	4,999	5,053	5,204	5,289	
	Operation weight		kg	2,135	2,169	2,543	2,628	2,777	4,422	2,795	4,463	4,496	2,812	4,780	5,186	5,200	5,280	5,602	5,615	5,670	5,881	5,970	
Water heat exchanger - evaporator	Type				Single pass shell and tube																		
	Water volume			l	124	118	176	170	274	344	266	344	325	251	325	538		505		495	539	527	
	Water flow rate	Nom.		l/s	18.1	22.1	26.8	30.4	34.7	38.0	41.1	41.6	45.8	48.0	50.3	56.5	59.9	63.2	69.5	76.5	84.1	91.0	98.7
Water heat exchanger - condenser	Water pressure drop	Cooling	Nom.	kPa	48	63	44	47	54	53	49	62	58	56	69	45	54	59	69	88	97	120	
	Type				Single pass shell and tube																		
	Water flow rate	Nom.		l/s	22.4	27.4	33.2	37.7	43.1	23.3	51.3	23.3	28.2	60.1	28.2	34.7	34.8	38.9	43.0	43.4	52.0	52.3	60.9
Compressor	Water flow rate 2	Nom.		l/s	-				23.3	-	27.9	28.2	-	33.8	34.7	38.9		43.0	51.3	52.0	60.1	60.9	
	Water pressure drop	Cooling	Nom.	kPa	59	63	67	65	16	64	20	64	67	26	67	73	69	16	17	15	15	15	
	Water pressure drop 2	Cooling	Nom.	kPa	-				64	-	66	67	-	69	73	69		16	19	17	14	15	
Sound power level	Type				Single screw compressor																		
	Quantity				1				2	1	2	1	2										
Sound pressure level	Cooling	Nom.		dB(A)	100	101	102		105	102	105	103	105	107		106		107		108	108		
Operation range	Cooling	Nom.		dB(A)	82	83	84		83	84	85		86		87		86		87		88		
	Evaporator	Cooling	Min.-Max.	°CDB	-4~10																		
Refrigerant	Condenser	Cooling	Min.-Max.	°CDB	25~45																		
	Type / GWP				R-410A / 2,087.5																		
Refrigerant charge	Circuits	Quantity			1				2	1	2	1	2										
	Per circuit			kg	120.0	100.0	175.0	90.0	80.0	85.0	90.0	45.0	85.0	100.0	160.0	100.0	150.0	130.0	150.0	160.0	130.0		
Piping connections	Evaporator water inlet/outlet			mm	152.4	203.2										254							
	Condenser water inlet/outlet			inch	5	6		5					6			5							
Unit	Maximum starting current			A	455				656	599	656	626	656	663	690	902	954	988					
	Nominal running current (RLA)	Cooling		A	149	175	211	237	269	299	329	325	352	391	387	423	449	476	539	596	650	702	755
	Maximum running current			A	179	214	259	294	308	358	372	393	427	434	473	519	553	587	615	679	744	771	830
Power supply	Phase/Frequency/Voltage			Hz/V	3~/50/400																		

Water cooled screw chiller, high efficiency, standard sound



EWWQ-B-SS/XS

MicroTech III

Cooling only				EWQ-B-XS																	
				420	520	640	730	800	970	C10	C11	C12	C13	C14	C15	C16	C17	C19	C20	C21	
Cooling capacity	Nom.	kW		420	513	636	722	798	969	1,033	1,111	1,153	1,265	1,363	1,442	1,580	1,740	1,870	2,025	2,156	
Power input	Cooling	kW		88.7	107	131	149	166	201	213	239	238	262	281	299	324	361	397	436	474	
Capacity control	Method	Stepless																			
	Minimum capacity	%		12.5						25.0	12.5	25.0									
EER				4.74	4.79	4.84	4.83	4.81	4.86	4.64	4.85	4.83	4.85	4.83	4.88	4.81	4.71	4.64	4.55		
ESEER				5.27	5.29	5.37	5.36	5.30	5.09	5.56	4.99	5.52	5.65	5.61	5.26	5.18	4.98	4.91	4.75		
IPLV				6.36	6.45	6.42	6.35	6.06	6.11	5.92	6.06	6.07	6.23	6.19	5.82	5.92	6.03	5.81	5.93		
Dimensions	Unit	Height	mm	2,001				2,003	2,001	2,454	2,003	2,454				2,495					
		Width	mm	1,276		1,268	1,314	1,446	1,350	1,446	1,350				4,865						
		Depth	mm	3,863		3,878	3,920	5,219	3,919	5,219				4,829							
Weight	Unit	kg			2,322	2,403	2,464	2,738	2,407	2,427	4,775	2,457	4,831	4,873	4,919	4,969	5,117	5,388	5,408	5,414	
	Operation weight	kg			2,594	2,685	2,745	3,158	2,815	3,056	5,431	3,086	5,479	5,512	5,546	5,606	5,794	5,843	6,110	6,118	6,124
Water heat exchanger - evaporator	Type	Single pass shell and tube																			
	Water volume	l		220	213	200	334	325	538	587	538	575	563	551	495	484	535	527			
	Water flow rate	Nom.	l/s	20.1	24.6	30.5	34.6	38.2	46.4	49.5	53.2	55.2	60.6	65.3	69.1	75.7	83.5	89.7	97.2	103.6	
Water heat exchanger - condenser	Water pressure drop	Cooling	Nom.	kPa	55	68	71	64	57	53	68	64	55	67	74	69	88	90	111	124	
	Type	Single pass shell and tube																			
	Water flow rate	Nom.	l/s	24.4	29.8	36.8	41.8	46.3	56.2	29.9	64.7	30.2	36.7	37.2	41.8	45.7	46.2	54.4	55.1	63.1	
Compressor	Water flow rate 2	Nom.	l/s	-					29.9	-	36.6	36.7	41.8	45.7	54.7	54.4	63.0	63.1			
	Water pressure drop 2	Cooling	Nom.	kPa	50	39	42	47	59	64	40	82	36	48	49	46	44	45	60	61	78
	Water pressure drop 2	Cooling	Nom.	kPa	-					40	-	47	48	46	44	60	78				
Sound power level	Type	Single screw compressor																			
	Quantity				1			2	1	2											
Sound pressure level	Cooling	Nom.	dB(A)	101	102	103	102	103	105	104	106	107	106	107	108						
	Cooling	Nom.	dB(A)	82	83	84	83	84	86	85	86	87	86	87	88						
Operation range	Evaporator	Cooling	Min.-Max.	-4~10																	
	Condenser	Cooling	Min.-Max.	25~45																	
Refrigerant	Type / GWP	R-410A / 2,087.5																			
	Circuits	Quantity				1			2	1	2										
Refrigerant charge	Per circuit	kg		120.0	130.0	95.0	135.0	110.0	150.0	120.0	130.0	120.0	150.0	120.0	150.0	130.0	150.0				
		TCO _{2eq}		250.5	271.4	198.3	281.8	229.6	313.1	250.5	271.4	250.5	313.1	250.5	313.1	271.4	313.1				
Piping connections	Evaporator water inlet/outlet	mm		152.4			203.2	254	203.2	254	203.2			254							
	Condenser water inlet/outlet	inch		8			6	5	6	5	6			8							
Unit	Maximum starting current	A			455			656	626	656	663	690	902	954	988	998					
	Nominal running current (RLA)	Cooling	A	149	173	208	235	258	313	346	370	381	417	443	469	511	567	621	678	734	
	Maximum running current	A			179	214	259	294	308	372	427	434	473	519	553	587	615	679	744	771	830
Power supply	Phase/Frequency/Voltage	3~/50/400																			

Water cooled scroll heat pump

- › One of the most **compact units** on the market: 600mm x 600mm x 600mm
- › Low energy consumption
- › Low operating sound level
- › Low refrigerant volume
- › Stainless steel plate heat exchanger
- › Extension possible to 195kW
- › Easy installation and maintenance
- › Remote cooling or heating selection
- › Water/water heat pump, with water reversibility
- › Compatible with hydraulic module EHMC (see next page)
- › Advanced μC^2SE controller for direct connection to a Modbus based BMS or to a remote user interface
- › Standard integrated: main switch, water filter, flow switch, air purge, pressure ports



Heating only & Cooling only				EWWP-KBW1N																																	
				014	022	028	035	045	055	065	090	100	110	120	130	145	155	165	175	185	195																
Cooling capacity	Nom.			kW		12.9	21.4	27.8	32.3	42.8	55.7	64.7	85.7	98.6	112.0	121.0	130.0	141.0	154.0	167.0	176.0	185.0	194.0														
Heating capacity	Nom.			kW		16.7	27.5	35.6	41.5	55.0	71.7	83.0	110.0	127.0	143.0	155.0	166.0	182.0	198.0	215.0	226.0	237.0	249.0														
Power input	Cooling	Nom.			kW		3.8	6.1	7.8	9.1	12.2	16.0	18.2	24.2	28.0	31.9	34.0	36.2	40.2	43.9	47.7	49.8	52.0	54.1													
	Heating	Nom.			kW		3.8	6.1	7.8	9.1	12.2	16.0	18.2	24.2	28.0	31.9	34.0	36.2	40.2	43.9	47.7	49.8	52.0	54.1													
EER						3.44	3.49	3.54	3.51	3.48	3.55	3.54	3.52	3.51	3.56	3.59	3.51	3.50	3.53	3.56	3.59																
COP						4.45	4.49	4.54	4.55	4.51	4.48	4.56	4.55	4.54	4.48	4.56	4.59	4.53	4.51	4.54	4.56	4.60															
Space heating	Average climate water outlet 55°C	General	η_s (Seasonal space heating efficiency)	%	107	106	115	116	102	109	113																										
					SCOP	2.88	2.86	3.08	3.11	2.75	2.91	3.03																									
	Average climate water outlet 35°C	General	η_s (Seasonal space heating efficiency)	%	132	134	138	143	136	139	142																										
					SCOP	3.49	3.55	3.66	3.78	3.59	3.66	3.74																									
Dimensions	Unit	Height	mm		600						1,200						1,800																				
		Width	mm		600																																
		Depth	mm		600						1,200																										
Weight	Unit	kg		118	155	165	172	300	320	334	600	620	640	654	668	920	940	960	974	988	1,000																
Water heat exchanger - evaporator	Type	Brazen plate																																			
	Minimum water volume in the system	l		62	103	134	155	205	268	311	205	268	311	205	268	311																					
	Water flow rate	Min.	l/min		31.0	53.0	65.0	76.0	101	131	152	202	232	262	283	304	333	363	393	414	435	456															
		Nom.	l/min		37.0	61.0	80.0	93.0	123	160	185	246	283	321	347	373	404	441	479	505	530	556															
Water heat exchanger - condenser	Type	Water flow rate	Min.	l/min		24	39	51	59	79	100	120	160	180	210	220	240	260	280	310	320	340	360														
			Nom.	l/min		48	78	100	120	160	210	240	310	360	410	440	470	520	570	610	650	680	710														
			Max.	l/min		95	160	200	240	310	410	470	630	720	820	880	950	1,000	1,100	1,200	1,300	1,400															
Compressor	Type	Hermetically sealed scroll compressor																																			
	Quantity			1				2				4		2		4		2		4				6		4		6									
Compressor 2	Quantity			-																		2		-		2		-		2		-		2		-	
Sound power level	Cooling	Nom.	dBA		64.0		71.0		67.0		74.0		71.0		75.0		77.0		73.0		76.0		79.0														
Operation range	Evaporator	Cooling	Min.-Max.	°CDB		-10~20																															
	Condenser	Cooling	Min.-Max.	°CDB		20~55																															
Refrigerant	Type / GWP	R-407C / 1,773.9																																			
	Control	Thermostatic expansion valve																																			
	Circuits	Quantity	1				2				4				6																						
Refrigerant charge	Per circuit	kg	1.20		2.00		2.50		3.10		4.60		5.60		9.20		10.2		11.2		13.8		14.8		15.8		16.8										
		TCO ₂ eq	2.13		3.55		4.43		5.50		8.16		9.93		16.3		18.1		19.9		24.5		26.3		28.0		29.8										
Piping connections	Evaporator water inlet/outlet (OD)	FBSP 25mm																																			
	Evaporator water drain	Field installation																																			
	Condenser water inlet/outlet (OD)	FBSP 25mm						FBSP 40mm						2 x 2 x FBSP 38mm						3 x 2 x FBSP 38mm																	
Unit	Starting current	Max	A		-																																
	Running current	Cooling	Nom.	A		66.0	104	131	15.0	208	262	30.0	416	47.0	524	562	60.0	678	732	786	824	862	90.0														
		Max	A		9.00	145	185	22.0	28.0	36.0	40.0	56.0	64.0	72.0	76.0	80.0	92.0	100	108	112	116	120															
Power supply	Phase/Frequency/Voltage	Hz/V		3N~/50/400																																	

Water cooled scroll chiller

Combination table

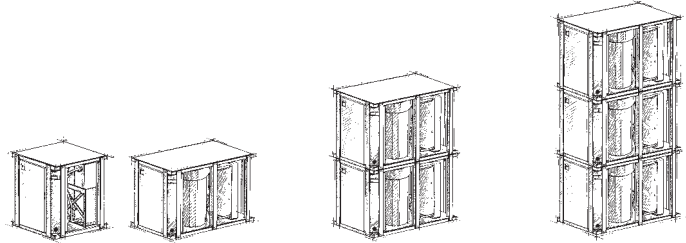

Selection table		1 Module (KB-series)						2 Modules (KB-series)						3 Modules (KB-series)					
Capacity index		014	022	028	035	045	055	065	090	100	110	120	130	145	155	165	175	185	195
Cooling capacity (kW)		12.9	21.4	27.8	32.3	42.8	55.7	64.7	85.7	98.6	112	121	130	141	154	167	176	185	194
Heating capacity (kW)		16.7	27.5	35.6	41.5	55.0	71.7	83.0	110	127	143	155	166	182	198	215	226	237	249
Unit + Control (Factory mounted)	EWWP014KBW1N	1	-	-	-	-	-	-	-	-	-	-	-	-	-	-	-	-	-
	EWWP022KBW1N	-	1	-	-	-	-	-	-	-	-	-	-	-	-	-	-	-	-
	EWWP028KBW1N	-	-	1	-	-	-	-	-	-	-	-	-	-	-	-	-	-	-
	EWWP035KBW1N	-	-	-	1	-	-	-	-	-	-	-	-	-	-	-	-	-	-
	EWWP045KBW1N	-	-	-	-	1	-	-	-	-	-	-	-	-	-	-	-	-	-
	EWWP055KBW1N	-	-	-	-	-	1	-	-	-	-	-	-	-	-	-	-	-	-
Modular units (Controller available as accessory)	EWWP065KBW1N	-	-	-	-	-	-	1	-	-	-	-	-	-	-	-	-	-	-
	EWWP045KAW1M	-	-	-	-	-	-	-	2	1	-	-	-	2	1	-	-	-	-
	EWWP055KAW1M	-	-	-	-	-	-	-	-	1	2	1	-	1	2	3	2	1	-
Control (Kit)	EWWP065KAW1M	-	-	-	-	-	-	-	-	-	1	2	-	-	-	1	2	3	
	ECB2MUAW	-	-	-	-	-	-	-	1	1	1	1	1	-	-	-	-	-	-
	ECB3MUAW	-	-	-	-	-	-	-	-	-	-	-	-	1	1	1	1	1	1

For example: for a 121 kW HP system, select : EWWP055KBW1N + EWWP065KBW1N

EHMC

Hydraulic Module

- › Accessory for EWWP-KBW1N chillers
- › 3 models available
- › 100 l tank for all sizes
- › Freeze up protection
- › High static pump (option)
- › Standard drain kit (for indoor use)
- › Standard dual pressure ports (before & behind the pump)

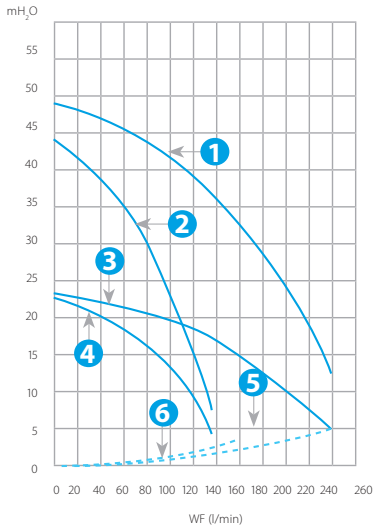

- Legends**
- Pump characteristics
1. EHMC30AV1080
 2. EHMC10AV1080 & EHMC15AV1080
 3. EHMC30AV1010
 4. EHMC10AV1010 & EHMC15AV1010
- Hydraulic module + filter pressures losses
5. EHMC15/30AV1010 & EHMC15/30AV1080
 6. EHMC10AV1010 & EHMC10AV1080



EHMC-AV

EHMC-AV		10		15		30	
		1010	1080	1010	1080	1010	1080
Nominal flow	l/min	62		88		187	
Nominal ESP	mH ₂ O	17	34	15	27	10	27
Nominal input	W	630	1,050	650	1,070	1,070	2,090
Dimensions (HxWxD)	mm	1,284x635x688		1,284x635x688		1,284x635x688	
Machine weight	kg	99	101	102	104	105	111
Sound power	dB(A)	63		63		63	
Sound pressure	dB(A)	52		52		52	
Power supply	V1	1~/230V/50Hz					
Operation range	Water side	-10°C ~ 55°C					
	Air side	°CDB -10°C ~ 43°C					
Piping connections	Water inlet/outlet	1" BSPF		2" BSPF		2-1/2" BSPF	
	Drain connection	1/2"					

Water cooled multi-scroll heat pump reversing on refrigerant side, standard efficiency, standard sound

- › Single refrigerant circuit (2 scroll compressors) with single evaporator
- › Heat pump version with reversibility on refrigerant side available, ideal for geothermal applications
- › Compact design to allow easy indoor installation or retrofit operations
- › Conceived for stacked installation of two single circuit units to reduce the footprint
- › High efficiency and reliable scroll compressor
- › High flexibility for a wide variety of applications
- › Allows sequencing control (up to 4 units) without any external device
- › Stainless steel plate heat exchanger
- › Pump (low 100 kPa and high 200 kPa lift) available for evaporator and condenser



EWHQ-G-SS

Heating & Cooling					EWHQ-G-SS													
					100	120	130	150	160	190	210	240	270	340	400			
Cooling capacity	Nom.				kW	87.3	100.0	111	127	141	160	181	208	232	291	352		
Heating capacity	Nom.				kW	112	128	144	162	179	205	233	266	299	375	454		
Power input	Cooling	Nom.			kW	22.4	25.3	28.5	32.0	35.6	41.1	46.0	53.3	59.1	73.7	88.4		
			Heating	Nom.				kW	27.0	30.9	35.2	39.3	43.6	50.4	56.6	64.7	72.2	90.3
Capacity control	Method				Step													
	Minimum capacity				%	50.0	43.0	50.0	44.0	50.0	45.0	50.0	43.0	50.0	40.0	50.0		
EER						3.90	3.95	3.91	3.96	3.95	3.90	3.93	3.90	3.92	3.95	3.98		
ESEER						4.70	4.84	4.65	4.86	4.80	4.89	4.86	4.83	4.79	4.90	4.83		
COP						4.15	4.16	4.09	4.12	4.11	4.07	4.11	4.10	4.14	4.16	4.18		
IPLV						6.02	6.14	5.66	5.84	5.73	5.84	5.81	5.87	5.71	5.86	5.79		
Space heating	Average climate water outlet 35°C	General	ηs (Seasonal space heating efficiency)	%														
					SCOP		160			163	167	166			172	171	163	-
					4.08		4.14	4.24	4.23			4.22	4.37	4.35	4.16	-		
Dimensions	Unit	Height		mm	1,066										1,186			
		Width		mm	928													
		Depth		mm	2,432			2,264			2,432							
Weight	Unit				kg	519	608	728	770	808	838	880	930	941	1,090	1,203		
	Operation weight				kg	558	654	782	830	873	908	995	1,019	1,031	1,202	1,334		
Water heat exchanger - evaporator	Type				Plate heat exchanger													
	Water volume				l	6	8		10	12	13	15	17		27	34		
	Water flow rate	Cooling	Nom.			l/s	4.2	4.8	5.3	6.1	6.7	7.7	8.7	10.0	11.1	13.9	16.9	
				Heating	Nom.				l/s	4.1	4.7	5.2	5.9	6.5	7.4	8.5	9.6	10.9
	Water pressure drop	Cooling	Nom.					kPa	44		35	30	29	31	33	31	38	42
Heating				Nom.			kPa		42		33	28	27	29	32	29	37	41
	Water heat exchanger - condenser	Type				Plate heat exchanger												
Water volume				l	6	8		10	12	13	15	17		27	34			
Water flow rate		Cooling	Nom.			l/s	5.2	6.0	6.7	7.7	8.5	9.7	10.9	13.7	13.9	17.4	21.1	
				Heating	Nom.				l/s	5.4	6.2	7.0	7.8	8.7	9.9	11.2	12.5	14.3
Water pressure drop		Cooling	Nom.					kPa	69		55	49	48	51	54	32	39	66
	Heating			Nom.			kPa		73		59	51	50	53	57	33	42	70
Compressor		Type				Scroll compressor												
	Quantity				2													
Sound power level	Cooling	Nom.			dBA	80	83	85	87	88			90	92	93			
			Sound pressure level	Cooling		Nom.			dBA	64	67	69	70	72			74	76
Operation range	Evaporator	Cooling			Min.-Max.		°CDB	-8~15										
			Condenser	Cooling		Min.-Max.		°CDB	25~55									
Refrigerant	Type / GWP				R-410A / 2,087.5													
	Circuits				1													
Refrigerant charge	Per circuit				kg	9.0		10.0		13.0	11.0	13.0	15.0		19.0			
	TCO ₂ eq					18.8		20.9		27.1	23.0	27.1	31.3		39.7			
Piping connections	Evaporator water inlet/outlet (OD)				1" 1/2													
	Condenser water inlet/outlet (OD)				2" 1/2													
Unit	Starting current		Max		A	204	255	261	308	316	354	368	466	481	640	677		
	Running current	Cooling	Nom.			A	43	46	50	56	63	71	78	88	97	123	148	
				Max					A	59	66	72	80	88	102	116	131	145
Power supply	Phase/Frequency/Voltage				Hz/V	3~/50/400												

Water cooled multi-scroll chiller, standard efficiency, standard sound

- › Single refrigerant circuit (2 scroll compressors) with single evaporator
- › Heat pump version available
- › Compact design to allow easy indoor installation or retrofit operations
- › Conceived for stacked installation of two single circuit units to reduce the footprint
- › High efficiency and reliable scroll compressor
- › High flexibility for a wide variety of applications
- › Allows sequencing control (up to 4 units) without any external device
- › Stainless steel plate heat exchanger
- › Pump (low 100 kPa and high 200 kPa lift) available for evaporator and condenser



Heating only & Cooling only					EWQ-G-SS												
					090	100	120	130	150	170	190	210	240	300	360		
Cooling capacity	Nom.				kW	93.7	106	119	136	150	172	194	221	246	314	370	
Heating capacity	Nom.				kW	118	133	150	169	187	215	244	276	310.00	396	468	
Power input	Cooling				Nom.	kW	21.3	24.0	26.9	30.5	33.9	38.9	43.8	50.7	56.1	70.2	84.0
	Heating				Nom.	kW	25.7	29.2	32.9	37.2	41.4	47.6	53.7	61.3	68.3	85.6	103
Capacity control	Method				Step												
	Minimum capacity				%	50.0	43.0	50.0	44.0	50.0	45.0	50.0	43.0	50.0	40.0	50.0	
EER					4.40		4.42	4.46	4.42		4.35		4.39	4.48	4.41		
ESEER					5.51	5.52	5.51	5.53	5.51	5.53	5.52						
COP					4.58	4.56	4.55		4.53	4.52	4.54	4.50	4.54	4.62	4.56		
IPLV					6.71	6.79	6.22	6.36	6.22	6.32	6.30	6.31	6.10	6.28	6.16		
Space heating	Average climate water outlet 35°C	General	ηs (Seasonal space heating efficiency)	%	168		170	173			172	169	167	171	-		
					4.28		4.33	4.40	4.39	4.40	4.38	4.29	4.25	4.34	-		
Dimensions	Unit	Height			1,066										1,186		
		Width			928												
		Depth			2,432		2,264			2,432							
Weight	Unit	kg			516	606	728	762	795	832	871	921	934	1,083	1,181		
		Operation weight			kg	555	652	782	821	859	901	946	1,010	1,023	1,195	1,311	
Water heat exchanger - evaporator	Type				Plate heat exchanger												
	Water volume				l	6	8	10	12	13	15	17	27	34			
	Water flow rate	Cooling	Nom.	l/s	4.5	5.1	5.7	6.5	7.2	8.2	9.3	10.6	11.8	15.1	17.7		
					Heating	Nom.	l/s	4.4	5.0	5.6	6.3	7.0	8.0	9.1	10.3	11.6	14.9
Water pressure drop	Cooling	Nom.	kPa	49				39	33		35	37	34	42	47		
				Heating	Nom.	kPa	47	38	31		33	35	32	41	46		
Water heat exchanger - condenser	Type						Plate heat exchanger										
	Water volume				l	6	8	10	12	13	15	17	27	34			
	Water flow rate	Cooling	Nom.	l/s	5.5	6.2	7.1	8.0	8.9	10.2	11.4	13.0	14.5	18.5	21.8		
					Heating	Nom.	l/s	5.7	6.4	7.3	8.2	9.1	10.4	11.8	13.3	15.0	19.1
Water pressure drop	Cooling	Nom.	kPa	72				73	60	50		52	56	46	57	69	71
				Heating	Nom.	kPa	76	77	63	52		54	59	48	61	74	76
Compressor	Type						Scroll compressor										
	Quantity				2												
Sound power level	Cooling	Nom.				80	83	85	87	88			90	92	93		
			Sound pressure level	Cooling	Nom.				64	67	69	70	72			74	76
Operation range	Evaporator	Cooling				Min.-Max.	°CDB	-10~15									
			Condenser	Cooling	Min.-Max.			°CDB	25~55								
Refrigerant	Type / GWP					R-410A / 2,087.5											
	Circuits				1												
Refrigerant charge	Per circuit				kg	10.0		11.0		12.0		15.0	16.0	17.0	19.0	20.0	
					TCO _{2eq}	20.9		23.0		25.1		31.3	33.4	35.5	39.7	41.8	
Piping connections	Evaporator water inlet/outlet (OD)				1" 1/2					2" 1/2					3"		
	Condenser water inlet/outlet (OD)				1" 1/2					2" 1/2					3"		
Unit	Starting current				Max	A	204	255	261	308	316	354	368	466	481	640	677
	Running current	Cooling	Nom.	A	42	45	48	54	61	68	76	86	95	118	143		
					Max	A	59	66	72	80	88	102	116	131	145	183	221
Power supply	Phase/Frequency/Voltage				Hz/V	3~/50/400											

Water cooled multi-scroll chiller, standard efficiency, standard sound

- › Dual refrigerant circuit (4 scroll compressors) with single evaporator
- › Heat pump version available
- › Compact design to allow easy indoor installation or retrofit operations
- › High efficiency and reliable scroll compressor
- › Stainless steel plate heat exchanger
- › High flexibility for a wide variety of applications
- › Allows sequencing control (up to 4 units) without any external device
- › Pump (low 100 kPa and high 200 kPa lift) available for evaporator and condenser



EWQ-L-SS

Heating only & Cooling only				EWQ-L-SS	180	205	230	260	290	330	380	430	480	540	600	660	720				
Cooling capacity	Nom.			kW	187	215	244	273	303	345	387	430	476	549	611	663	721				
Heating capacity	Nom.			kW	234	269	305	339	377	430	486	537	601	692	773	843	917				
Power input	Cooling	Nom.			kW	41.7	47.3	53.1	60.2	67.1	77.1	87.0	97.9	110	124	140	154	167			
	Heating	Nom.			kW	50.5	57.5	65.0	73.6	82.0	94.4	107	118	133	150	171	188	204			
Capacity control	Method			Step																	
	Minimum capacity			%	25.0	21.0	25.0	22.0	25.0	23.0	25.0	21.0	25.0	22.0	20.0	18.0	25.0				
EER					4.49	4.55	4.60	4.53	4.52	4.47	4.45	4.39	4.34	4.44	4.37	4.31	4.32				
ESEER					5.54		5.52	5.53	5.54	5.53	5.54	5.52	5.51	5.55	5.51		5.52				
COP					4.64	4.67	4.68	4.60		4.56	4.55	4.54	4.51	4.60	4.53	4.48	4.49				
					6.77	6.84	6.35	6.38	6.31	6.32	6.36	6.37	6.16	6.29	6.23	6.20	6.18				
Space heating	Average climate water outlet 35°C	General	ηs (Seasonal space heating efficiency)	%	177	176	178	176	177												
					SCOP		4.08	4.14	4.24	4.23											
Dimensions	Unit	Height			1,970										2,090	2,210					
		Width													928						
		Depth													2,801						
Weight	Unit			kg	877	1,062	1,285	1,347	1,439	1,498	1,559	1,673	1,722	1,842	1,926	2,105	2,229				
				kg	957	1,156	1,401	1,469	1,575	1,641	1,723	1,851	1,918	2,044	2,145	2,346	2,405				
Water heat exchanger - evaporator	Type		Plate heat exchanger																		
	Water volume			l	35	41	53		65		76		92		115						
		Water flow rate	Cooling	Nom.	l/s	9.0	10.3	11.7	13.0	14.5	16.5	18.5	20.6	22.8	26.3	29.3	31.8	34.6			
	Heating		Nom.	l/s	8.8	10.1	11.5	12.7	14.1	16.1	18.2	20.1	22.4	26.0	28.9	31.4	34.2				
Water pressure drop	Cooling	Nom.	kPa	28		23	28	25	32		33		40	51	50	59	69				
	Heating	Nom.	kPa	27		22	27	24	31		39		50	48	58	68					
Water heat exchanger - condenser	Type		Plate heat exchanger																		
	Water volume			l	19	22	29		35		41		49		62						
		Water flow rate	Cooling	Nom.	l/s	5.5	6.3	7.2	8.1	9.0	10.2	11.4	12.7	14.0	14.5	18.0	17.9	21.3			
	Heating		Nom.	l/s	11.3	13.0	14.8	16.5	18.3	20.9	23.5	25.9	28.9	33.4	37.2	40.5	44.2				
	Water flow rate 2	Cooling	Nom.	l/s	5.5	6.3	7.2	8.1	9.0	10.2	11.4	12.7	14.0	17.8	18.0	21.3					
		Water pressure drop	Cooling	Nom.	kPa	72	73	61	49	50	51	55	46	57	43	67		68			
Heating	Nom.	kPa	76	77	64	52		53		59	48	60	70	72	73						
Water pressure drop 2	Cooling	Nom.	kPa	72	73	61	49	50	51	55	46	57	66	67	68						
Compressor	Type		Scroll compressor																		
	Quantity		4																		
Sound power level	Cooling	Nom.			dB(A)	83	86	88	90	91		93		95		96					
	Sound pressure level	Cooling	Nom.			dB(A)	65	68	70	72	74		73		76		77		78		
Operation range	Evaporator	Cooling	Min.-Max.			-10~15															
	Condenser	Cooling	Min.-Max.			25~55															
Refrigerant	Type / GWP		R-410A / 2,087.5																		
	Circuits				2																
Refrigerant charge	Per circuit				kg	10.0		11.0		12.0		15.0		16.0		17.0		19.0		20.0	
					TCO ₂ eq	20.9		23.0		25.1		31.3		33.4		35.5		39.7		41.8	
Piping connections	Evaporator water inlet/outlet (OD)		3"																		
	Condenser water inlet/outlet (OD)				1" 1/2				2" 1/2				3"								
Unit	Starting current	Max		A	263	320	333	388	403	456	484	597	626	785	822	860	898				
	Running current	Cooling	Nom.	A	83	89	96	109	121	137	151	171	189	210	236	260	284				
		Max		A	118	131	144	160	175	205	232	262	290	328	366	403	441				
Power supply	Phase/Frequency/Voltage				Hz/V	3~/50/400															



Water cooled screw chiller, standard efficiency, standard sound

- › Stepless single-screw compressor
- › 1-2 truly independent refrigerant circuits
- › Standard electronic expansion valve
- › DX shell and tube evaporator – one pass refrigerant side for easy oil circulation and return
- › Partial and total heat recovery option available
- › MicroTech III controller with superior control logic and easy interface

Heating only & Cooling only				EWWD-G-SS											
				170	210	260	300	320	380	420	460	500	600		
Cooling capacity	Nom.			kW	165	200	252	279	332	370	401	446	492	554	
Heating capacity	Nom.			kW	209	253	319	357	420	467	506	566	626	710	
Power input	Cooling	Nom.			kW	43.8	52.6	67.4	78.5	87.5	96.4	105	119	134	157
	Heating	Nom.			kW	43.8	52.6	67.4	78.5	87.5	96.4	105	119	134	157
Capacity control	Method			Stepless											
	Minimum capacity			25.0					12.5						
EER				3.77	3.80	3.74	3.55	3.80	3.84	3.80	3.74	3.68	3.53		
ESEER				4.50	4.54	4.46	4.25	4.75	4.80	4.76	4.67	4.59	4.44		
COP				4.77	4.80	4.74	4.55	4.80	4.84	4.80	4.74	4.68	4.53		
IPLV				5.36	5.35	5.30	5.04	5.52	5.55		5.60	5.31	5.16		
Space heating	Average climate water outlet 35°C	General	ηs (Seasonal space heating efficiency) SCOP	%	165	164		159	-						
					4.20	4.17	4.18	4.06	-						
Dimensions	Unit	Height		mm	1,860				1,880						
		Width		mm	920				860						
		Depth		mm	3,435				4,305						
Weight	Unit	Operation weight		kg	1,393	1,410	1,503	2,687	2,697	2,702	2,757	2,762			
				kg	1,470	1,480	1,650	2,840	2,850	2,860	2,970				
Water heat exchanger - evaporator	Type			Single pass shell and tube											
	Water volume		l	60	56	123		118	113		173	168			
	Water flow rate	Nom.	l/s	7.9	9.6	12.1	13.4	15.9	17.7	19.2	21.4	23.6	26.5		
Water pressure drop		Cooling	Total	kPa	45	61	41	49	58	57	66	50		59	
Water heat exchanger - condenser	Type			Single pass shell and tube											
	Water flow rate	Nom.	l/s	10.0	12.1	15.3	17.1	10.1	10.2	12.2	12.4	15.0	17.0		
	Water flow rate 2	Nom.	l/s	-				10.1	12.2		14.8	15.0	17.0		
	Water pressure drop	Cooling	Nom.	kPa	38	39	60	73	37	38	39	41	57	70	
Water pressure drop 2		Cooling	Nom.	kPa	-				37	39		56	57	70	
Compressor	Type			Single screw compressor											
	Quantity			1					2						
Sound power level	Cooling	Nom.	dB(A)	88					90						
Sound pressure level	Cooling	Nom.	dB(A)	70					72						
Operation range	Evaporator	Cooling	Min.-Max.	°CDB									-8~15		
	Condenser	Cooling	Min.-Max.	°CDB									20~55		
Refrigerant	Type / GWP			R-134a / 1,430											
	Circuits	Quantity		1					2						
Refrigerant charge	Per circuit			kg	60.0					55.0					
				TCO ₂ eq	85.8					78.7					
Piping connections	Evaporator water inlet/outlet (OD)			88.9				114.3				139.7mm			
	Condenser water inlet/outlet (OD)			5"											
Unit	Starting current		Max	A	288				380	397		420		438	
	Running current	Cooling	Nom.	A	75	85	105	122	149	160	171	190	209	242	
		Max		A	114	136	165	186	229	250	272	301	330	373	
Power supply	Phase/Frequency/Voltage			Hz/V	3~/50/400										

Water cooled screw chiller, high efficiency, standard sound



EWWD-G-SS/XS

MicroTech III

Heating only & Cooling only		EWWD-G-XS		190	230	280	320	380	400	460	500	550	650		
Cooling capacity	Nom.	kW		185	222	276	306	365	407	443	495	539	602		
Heating capacity	Nom.	kW		226	272	337	379	446	496	540	602	657	743		
Power input	Cooling	Min.	kW	40.6	49.4	61.0	73.4	81.1	89.0	97.0	107	117	141		
	Heating	Nom.	kW	40.6	49.4	61.0	73.4	81.1	89.0	97.0	107	117	141		
Capacity control	Method			Stepless				Stepless							
	Minimum capacity		%	25.0				12.5							
EER				4.57	4.50	4.53	4.17	4.50	4.58	4.57	4.61	4.59	4.26		
ESEER				5.37	5.31	5.33	4.91	5.54	5.62	5.61	5.68	5.67	5.27		
COP				5.57	5.50	5.53	5.17	5.50	5.58	5.6	5.61	5.59	5.26		
IPLV				6.45	6.36	6.35	5.80	6.47	6.57	6.55	6.65	6.64	6.17		
Space heating	Average climate water outlet 35°C	General	ηs (Seasonal space heating efficiency) SCOP	%	187	184	185	175	-						
					4.75	4.68	4.69	4.44	-						
Dimensions	Unit	Height	mm	1,860				1,880							
		Width	mm	920				860							
		Depth	mm	3,435				4,305							
Weight	Unit	kg		1,650	1,665	1,680	2,800	2,945	2,955	2,975	2,990				
		Operation weight		kg	1,800	1,810	1,820	3,020	3,280	3,290	3,315	3,340			
Water heat exchanger - evaporator	Type	Single pass shell and tube													
	Water volume	l		125	120	110	170	285	280						
	Water flow rate	Nom.	l/s	8.9	10.6	13.2	14.6	17.5	19.5	21.2	23.7	25.8	28.8		
Water heat exchanger - condenser	Water pressure drop	Cooling	Total	kPa		23	31	30	37	28	21	24	33	39	47
				Type	Single pass shell and tube										
Compressor	Quantity	Single screw compressor													
		Cooling	Nom.	dB(A)	88				90						
		Sound pressure level	Cooling	Nom.	dB(A)	70				72					
		Operation range	Evaporator	Cooling	Min.-Max.	-8~-15				20~55					
Refrigerant	Type / GWP	R-134a / 1,430													
	Circuits	Quantity	1				2								
Refrigerant charge	Per circuit	kg		60.0				65.0		60.0		65.0		60.0	
		TCO _{2eq}		85.8				93.0		85.8		93.0		85.8	
Piping connections	Evaporator water inlet/outlet (OD)		114.3				139.7		168.3mm						
	Condenser water inlet/outlet (OD)		5"												
Unit	Starting current	Max	A	288				380		397		420		438	
	Running current	Cooling	Nom.	A	71	81	96	109	142	152	161	174	186	210	
		Max	A	114	136	165	186	229	250	272	301	330	373		
Power supply	Phase/Frequency/Voltage		Hz/V	3~/50/400											

Water cooled screw chiller, standard efficiency, standard sound

- › Stepless single-screw compressor
- › Optimised for use with R-134a
- › **One, two or three** truly independent **refrigerant circuits**
- › Standard electronic expansion valve
- › DX shell and tube evaporator – one pass refrigerant side to minimize pressure drops
- › Partial and total heat recovery option available
- › MicroTech III controller with superior control logic and easy interface

Heating only & Cooling only				EWWD-I-SS																					
				340	400	460	550	650	700	800	850	900	950	C10	C12	C13	C14	C15	C16	C17	C18				
Cooling capacity	Nom.			kW	332	392	458	536	637	703	779	841	907	982	1,024	1,151	1,200	1,270	1,341	1,395	1,449	1,503			
Heating capacity	Nom.			kW	405	481	562	660	783	863	955	1,032	1,112	1,207	1,267	1,412	1,475	1,560	1,648	1,721	1,793	1,866			
Power input	Cooling	Nom.			kW	73.5	88.6	104	124	146	160	176	191	205	225	243	262	275	290	307	325	344	363		
	Heating	Nom.			kW	73.5	88.6	104	124	146	160	176	191	205	225	243	262	275	290	307	325	344	363		
Capacity control	Method			Stepless																					
	Minimum capacity					25.0						12.5						8.3							
EER						4.51	4.43	4.39	4.31	4.37	4.38	4.41	4.40	4.42	4.37	4.22	4.40	4.36	4.38	4.37	4.29	4.21	4.14		
ESEER						4.55	4.46	4.44	4.37	4.99	5.18	5.00	5.13	4.92	5.05	4.82	4.96	5.00	4.99	5.00	4.91	4.79			
COP						5.51	5.43	5.39	5.31	5.37	5.38	5.41	5.40	5.42	5.37	5.22	5.40	5.36	5.38	5.37	5.29	5.21	5.14		
IPLV						5.41	5.28	5.26	5.19	5.83	6.27	5.81	6.16	5.76	5.90	5.64	5.71	5.74	5.76	5.74	5.65	5.45			
Dimensions	Unit	Height				1,821						2,103						2,323							
		Width				1,466						1,350						2,130							
		Depth				3,298						4,116						4,439							
Weight	Unit					kg		2,150	2,160	2,179	2,224	3,909	3,927	3,945	3,971	3,996	4,080	4,092	6,079	6,097	6,136	6,174	6,192	6,210	6,228
	Operation weight					kg		2,380	2,396	2,410	2,457	4,217	4,228	4,243	4,262	4,288	4,369	4,386	6,628	6,646	6,670	6,699	6,717	6,735	6,761
Water heat exchanger - evaporator	Type			Single pass shell and tube																					
	Water volume				l		193	183	172	271	263	256	248	241	233	472	504	489	472	464	456	448	440	432	
	Water flow rate		Nom.			l/s		15.9	18.8	21.9	25.7	30.5	33.6	37.3	40.3	43.4	47.0	49.0	55.1	57.4	60.8	64.2	66.8	69.4	72.0
	Water pressure drop	Cooling	Nom.			kPa		37	50	54	62	55	44	57	53	44	54	39	52	55	46	57	62	66	71
Heating		Nom.			kPa		37	50	54	62	55	44	57	53	44	54	39	52	55	46	57	62	66	71	
Water heat exchanger - condenser	Type			Single pass shell and tube																					
	Water flow rate		Nom.			l/s		19.5	23.1	27.0	31.7	18.8	19.1	23.0	23.2	26.8	27.2	30.5	22.6	22.9	26.4	26.4	29.9	29.9	
	Water flow rate 2		Nom.			l/s		-	-	-	-	18.8	22.4	23.0	26.5	26.8	30.8	30.5	22.6	26.1	26.4	29.9	29.9		
	Water flow rate 3		Nom.			l/s		-	-	-	-	-	-	-	-	-	-	-	22.6	25.6	26.1	26.4	29.9	29.9	
	Water pressure drop	Cooling	Nom.			kPa		26	28	30	26	25	27	28	26	22	23	24	25	24	25	24	24	23	23
		Heating	Nom.			kPa		26	28	30	26	25	26	27	28	26	23	24	25	24	25	24	24	23	23
	Water pressure drop 2	Cooling	Nom.			kPa		-	-	-	-	25	26	27	26	23	24	23	24	23	24	23	23	23	23
Water pressure drop 3	Cooling	Nom.			kPa		-	-	-	-	-	-	-	-	-	-	-	24	22	23	24	23	23	23	
Compressor	Type			Single screw compressor																					
	Quantity					1						2						3							
Sound power level	Cooling	Nom.			dBA		94	97	97	97	98	99	99	100	100	101	101	101	101	103	103	103	103	103	
Sound pressure level	Cooling	Nom.			dBA		75	76	78	78	79	80	81	81	81	81	81	81	81	83	83	83	83	83	
Operation range	Evaporator	Cooling	Min.-Max.			°CDB																			
	Condenser	Cooling	Min.-Max.			°CDB																			
Refrigerant	Type / GWP			R-134a / 1,430																					
Refrigerant charge	Circuits					1						2						3							
	Quantity					kg		54.0	52.0	60.0	55.0	60.0	75.0	55.0	50.0	52.0	51.7	51.3	51.0	50.7	50.3	58.0	58.0		
						TCO _{2eq}		77.2	74.4	85.8	78.7	85.8	107.3	78.7	71.5	74.4	73.9	73.4	72.9	72.5	72.0	82.9	82.9		
Piping connections	Evaporator water inlet/outlet (OD)			168.3mm																					
	Condenser water inlet/outlet (OD)			219.1mm																					
Unit	Maximum starting current					A		330	464	493	627	650	681	703	836	867	898	920	942	942	942	942	942		
	Nominal running current (RLA)		Cooling			A		119	145	166	196	236	262	288	310	329	355	382	431	450	470	493	520	547	574
	Maximum running current					A		204	233	271	299	407	436	465	504	542	570	597	698	737	775	814	841	868	896
Power supply	Phase/Frequency/Voltage					Hz/V		3~/50/400																	

Water cooled screw chiller, high efficiency, standard sound



EWWD-I-SS/XS

MicroTech III

Heating only & Cooling only				EWWD-I-XS	360	440	500	600	750	800	850	950	C10	C11	C12		
Cooling capacity	Nom.			kW	360	431	504	570	717	791	863	929	971	1,035	1,130		
Heating capacity	Nom.			kW	435	520	608	697	865	995	1,040	1,122	1,180	1,263	1,380		
Power input	Cooling	Nom.		kW	74.5	89.5	104	127	148	163	178	193	208	228	250		
	Heating	Nom.		kW	74.5	89.5	104	127	148	163	178	193	208	228	250		
Capacity control	Method			Stepless													
	Minimum capacity			%	25.0						12.5						
EER					4.83	4.82		4.50	4.85	4.84	4.85	4.81	4.66	4.53	4.51		
ESEER					4.81	4.74	4.70	4.60	5.52	5.68	5.41	5.53	5.31	5.45	5.10		
COP					5.83	5.82		5.50	5.85	5.84	5.85	5.81	5.66	5.53	5.51		
IPLV					5.72	5.63	5.57	5.47	6.45	6.89	6.33	6.63	6.19	6.35	5.97		
Dimensions	Unit	Height		mm	1,883						2,245						
		Width		mm	1,430						1,350						
		Depth		mm	4,012						4,782						
Weight	Unit			kg	2,594	2,667	2,704		4,964	4,997	5,049	5,073	5,097	5,132			
		Operation weight			kg	2,998	3,078	3,116		5,582	5,615	5,671	5,695	5,729	5,741		
Water heat exchanger - evaporator	Type			Single pass shell and tube													
	Water volume			l	326	317	308		539			528			504		
	Water flow rate	Nom.		l/s	17.3	20.7	24.1	27.3	34.4	37.9	41.3	44.5	46.6	49.5	54.1		
		Water pressure drop	Cooling	Nom.	kPa	64		54	68	58	68	56	64	72	46	52	
Heating	Nom.		kPa	64		54	68	58	68	56	64	72	46	52			
Water heat exchanger - condenser	Type			Single pass shell and tube													
	Water flow rate	Nom.		l/s	20.9	25.0	29.2	33.4	20.8	21.0	25.0		28.3			33.1	
		Nom.		l/s	-				20.8	24.9	25.0	28.8	28.3	32.3	33.1		
	Water pressure drop	Cooling	Nom.	kPa	48	47	51	66	48		47		50	51	65		
		Heating	Nom.	kPa	48	47	51	66	48		47	50		65			
Water pressure drop 2	Cooling	Nom.	kPa	-				48	47		50		65				
Compressor	Type			Single screw compressor													
	Quantity			1						2							
Sound power level	Cooling	Nom.		dB(A)	94	97			98			99	100				
Sound pressure level	Cooling	Nom.		dB(A)	75	76	78			79	80	81					
Operation range	Evaporator	Cooling	Min.-Max.	°CDB	-8~15												
	Condenser	Cooling	Min.-Max.	°CDB	20~55												
Refrigerant	Type / GWP			R-134a / 1,430													
	Circuits	Quantity		1						2							
Refrigerant charge	Per circuit			kg	100.0	87.0	130.0	105.0	90.0	88.5	87.0	86.0	85.0				
				TCO ₂ eq	143.0	124.4	185.9	150.2	128.7	126.6	124.4	123.0	121.6				
Piping connections	Evaporator water inlet/outlet (OD)			168.3mm						219.1mm							
	Condenser water inlet/outlet (OD)			5"													
Unit	Maximum starting current			A	330	464			493	627	650	681		703			
	Nominal running current (RLA)	Cooling		A	117	144	164	194	235	261	287	307	327	358	388		
		Maximum running current		A	204	233	271	299	407	436	465	504	542	570	597		
Power supply	Phase/Frequency/Voltage			Hz/V	3~/50/400												

Water cooled screw chiller, standard efficiency, standard sound

- › Compact design to allow easy indoor installation or retrofit operations
- › Daikin semi-hermetic single screw stepless compressor
- › High energy efficiency both at full and part load conditions
- › Chilled water temperatures down to -10°C on standard unit
- › Optimised for use with R-134a
- › MicroTech III controller with superior control logic and easy interface



Heating only & Cooling only				EWWD-J-SS																															
				120	140	150	180	210	250	280	310	330	360	380	400	450	500	530	560																
Cooling capacity	Nom.			kW																															
Heating capacity	Nom.			kW																															
Power input	Cooling	Nom.		kW																															
	Heating	Nom.		kW																															
Capacity control	Method			Stepless																															
	Minimum capacity			25.0								12.5																							
EER			%																																
ESEER			%																																
COP			%																																
IPLV			%																																
Space heating	Average climate water outlet 35°C	General	ηs (Seasonal space heating efficiency)	%																															
				173				171				163				167				175				165				159				-			
				4.40				4.34				4.14				4.15				4.24				4.46				4.21				4.04			
Dimensions	Unit	Height			mm																														
		Width			1,020								913																						
		Depth			mm																														
Weight	Unit			kg																															
		Operation weight		kg																															
Water heat exchanger - evaporator	Type			Plate heat exchanger																															
		Water volume		l																															
		Water flow rate	Nom.		l/s																														
		Water pressure drop	Cooling	Nom.		kPa																													
Heating	Nom.		kPa																																
Water heat exchanger - condenser	Type			Single pass shell and tube																															
		Water volume		l																															
		Water flow rate	Nom.		l/s																														
		Water pressure drop	Cooling	Nom.		kPa																													
			Heating	Nom.		kPa																													
		Water pressure drop2	Cooling	Nom.		kPa																													
Heating	Nom.		kPa																																
Compressor	Type			Single screw compressor																															
		Quantity		1																															
Sound power level	Cooling	Nom.		dBA																															
Sound pressure level	Cooling	Nom.		dBA																															
Operation range	Evaporator	Cooling	Min.-Max.		°CDB																														
	Condenser	Cooling	Min.-Max.		°CDB																														
Refrigerant	Type / GWP		R-134a / 1,430																																
	Circuits	Quantity		1								2																							
Refrigerant charge	Per circuit		kg																																
			TCO _{2eq}																																
Piping connections	Evaporator water inlet/outlet		mm																																
	Condenser water inlet/outlet (OD)		mm																																
Unit	Starting current	Max		A																															
		Running current	Cooling	Nom.		A																													
			Max		A																														
Power supply	Phase/Frequency/Voltage		Hz/V																																

Water cooled screw chiller, high efficiency, standard sound

- › High energy efficient units: **full range Eurovent Class A**
- › **Heat pump version** available
- › **Flooded type heat exchangers**
- › MicroTech III controller with superior control logic and easy interface



EWWD-H-XS

MicroTech III

Heating only & Cooling only				EWWD-H-XS	370	450	530	610	750	830	930	980	C10	C11	C12
Cooling capacity	Nom.		kW	368	444	520	606	745	825	930	975	1,047	1,130	1,212	
Heating capacity	Nom.		kW	432	520	608	709	873	965	1,083	1,141	1,224	1,321	1,416	
Power input	Cooling	Nom.	kW	65.2	77.8	89.8	104	130	143	156	168	179	193	207	
	Heating	Nom.	kW	64.0	76.7	88.4	103	128	140	154	166	177	191	204	
Capacity control	Method			Stepless											
	Minimum capacity		%	25.0						12.5					
EER				5.64	5.70	5.78	5.81	5.74	5.79	5.95	5.80	5.84		5.85	
ESEER				5.80	5.82	5.90	5.91	6.44	6.51	6.59	6.63	6.66	6.69	6.68	
COP				6.75	6.79	6.88	6.89	6.84	6.87	7.06	6.89	6.93		6.94	
IPLV				6.93	6.99	7.09	7.10	7.73	7.81	7.89	7.96	8.00	8.02		
Dimensions	Unit	Height	mm	2,121				2,048				2,161			
		Width	mm	1,353				1,384		1,689		1,711			
		Depth	mm	3,341		3,419		3,417		3,609				3,509	
Weight	Unit		kg	3,089	3,370	3,603	3,781	5,289	5,375	5,654	5,707	6,066	6,105	6,156	
	Operation weight		kg	3,250	3,588	3,870	4,163	5,694	5,835	6,174	6,262	6,709	6,773	6,859	
Water heat exchanger - evaporator	Type			Single pass shell and tube											
	Water volume		l	78	107	134	160	172	201	261	272	295	310	327	
	Water flow rate		Nom. l/s	17.6	21.2	24.9	29.0	35.7	39.5	44.5	46.7	50.1	54.1	58.0	
	Water pressure drop	Cooling	Nom. kPa	40	33		40	47	38	35	36	33	32		
Heating		Nom. kPa	40	33		40	47	38	35	36	33	32			
Water heat exchanger - condenser	Type			Single pass shell and tube											
	Water flow rate		Nom. l/s	20.8	25.1	29.3	34.2	42.1	46.5	52.2	55.0	59.0	63.7	68.3	
	Water pressure drop	Cooling	Nom. kPa	31	26	28	23	30	28	33	31	29	30		
		Heating	Nom. kPa	31	26	28	23	30	28	33	31	29	30		
Compressor	Type			Single screw compressor											
	Quantity			1				2							
Sound power level	Cooling	Nom. dBA	97	98	99		100	101		102	103				
	Cooling	Nom. dBA	78	79	80		81	82		83	84				
Operation range	Evaporator	Cooling	Min.-Max. °CDB	-8~-15											
	Condenser	Cooling	Min.-Max. °CDB	18~-60											
Refrigerant	Type / GWP			R-134a / 1,430											
	Circuits	Quantity		1											
Refrigerant charge	Per circuit		kg	180.0	210.0	230.0	250.0	270.0				300.0	320.0		
			TCO ₂ eq	257.4	300.3	328.9	357.5	386.1				429.0	457.6		
Piping connections	Evaporator water inlet/outlet		mm	168.3				219.1							
	Condenser water inlet/outlet		inch	6				8							
Unit	Maximum starting current		A	330			464	448	471		492		626	646	
	Nominal running current (RLA)	Cooling	A	107	124	141	166	213	231	249	266	283	307	330	
		Maximum running current		A	148	176	202	228	296	323	351	378	404	430	456
Power supply	Phase/Frequency/Voltage		Hz/V	3~/50/400											

Condenserless scroll chiller

- › One of the most **compact units** on the market: 600mmx600mmx600mm
- › Daikin scroll compressor
- › Electronic DDC controller
- › Low operating sound level
- › Low energy consumption
- › Low refrigerant volume
- › Easy installation and maintenance
- › Stainless steel plate heat exchanger
- › Compatible with hydraulic module EHMC
- › Standard integrated: main switch, pressure ports, flow switch, filter, shut-off valves and air purge
- › Advanced μC^2SE controller for direct connection to a Modbus based BMS or to a remote user interface.



Cooling only				EWLP-KBW1N	012	020	026	030	040	055	065
Cooling capacity	Nom.			kW	12.1	20.0	26.8	31.2	40.0	53.7	62.4
Power input	Cooling	Nom.		kW	4.2	6.6	8.5	10.1	13.4	17.8	20.3
Capacity steps number					1				2		
EER					2.88	3.03	3.15	3.09	2.99	3.02	3.07
Dimensions	Unit	HeightxWidthxDepth		mm	600x600x600				600x600x1,200		
Weight	Unit			kg	108	141	147	151	252	265	274
Water heat exchanger - evaporator	Minimum water volume in the system			l	62	103	134	155	205	268	311
	Type				Braze plate						
	Water flow rate	Min.		l/min	31	53	65	76	101	131	152
		Nom.		l/min	35	57	77	89	115	154	179
		Max.		l/min	69	115	154	179	229	308	357
	Model	Quantity			1						
Compressor	Type				Hermetically sealed scroll compressor						
	Quantity				1			2			
Sound power level	Cooling	Nom.		dBA	64			71	67		74
Operation range	Evaporator	Cooling	Min.-Max.	°CDB	-10~20						
	Condenser	Cooling	Min.-Max.	°CDB	25~60						
Refrigerant	Type / GWP				R-407C / 1,773.9						
	Control				Thermostatic expansion valve						
	Circuits			Quantity	1			2			
Piping connections	Evaporator water inlet/outlet (OD)				FBSP 25mm			FBSP 40mm			
	Evaporator water drain				Field installation						
Power supply	Phase/Frequency/Voltage			Hz/V	3N~/50/400						

Condenserless multi-scroll chiller, standard efficiency, standard sound

- › Single refrigerant circuit (2 scroll compressors) with single evaporator
- › For chilled water production, to be combined with a remote condensing unit
- › Compact design to allow easy indoor installation or retrofit operations
- › Conceived for stacked installation of two single circuit units to reduce the footprint
- › High efficiency and reliable scroll compressor
- › Stainless steel plate heat exchanger



EWLQ-G-SS

Cooling only				EWLQ-G-SS												
Cooling capacity		Nom.		090	100	120	130	150	170	190	210	240	300	360		
Power input	Cooling	Nom.		kW												
Capacity control	Method			Step												
	Minimum capacity			%	50.0	43.0	50.0	44.0	50.0	45.0	50.0	43.0	50.0	40.0	50.0	
EER				3.86	3.81	3.78	3.79		3.80	3.86	3.80	3.85	3.84	3.77		
Dimensions	Unit	Height		mm												
		Width		mm												
		Depth		mm												
Weight	Unit		kg													
	Operation weight		kg													
Water heat exchanger - evaporator	Type			Plate heat exchanger												
	Water volume		l													
	Water flow rate	Nom.		l/s												
Compressor	Type			Scroll compressor												
	Quantity			2												
Sound power level	Cooling		Nom.		dBA											
	Cooling		Nom.		dBA											
Operation range	Evaporator	Cooling	Min.~Max.		°CDB											
	Condenser	Cooling	Min.~Max.		°CDB											
Refrigerant	Type / GWP			R-410A / 2,087.5												
	Circuits			Quantity												
Piping connections	Evaporator water inlet/outlet (OD)			1" 1/2				2" 1/2				3"				
	Unit	Starting current		Max		A										
Running current		Cooling		Nom.		A										
	Max		A													
Power supply	Phase/Frequency/Voltage			Hz/V												

Condenserless multi-scroll chiller, standard efficiency, standard sound

- › Dual refrigerant circuit (4 scroll compressors) with single evaporator
- › For chilled water production, to be combined with a remote condensing unit
- › Compact design to allow easy indoor installation or retrofit operations
- › High efficiency and reliable scroll compressor
- › Stainless steel plate heat exchanger



EWLQ-L-SS

Cooling only				EWLQ-L-SS	180	205	230	260	290	330	380	430	480	540	600	660	720							
Cooling capacity	Nom.		kW	173	197	224	249	279	317	361	409	459	511	571	624	676								
Power input	Cooling	Nom.	kW	44.3	51.1	57.9	65.6	73.2	83.8	93.5	108	119	135	152	168	184								
Capacity control	Method			Step																				
	Minimum capacity		%	25.0	21.0	25.0	22.0	25.0	23.0	25.0	21.0	25.0	22.0	20.0	18.0	25.0								
EER				3.91	3.86	3.87	3.79	3.81	3.78	3.86	3.79	3.84	3.78	3.76	3.71	3.67								
Dimensions	Unit	Height	mm	1,970																				
		Width	mm	928																				
		Depth	mm	2,801																				
Weight	Unit		kg	832	1,007	1,202	1,252	1,333	1,380	1,432	1,511	1,560	1,609	1,694	1,833	1,957								
	Operation weight		kg	894	1,081	1,292	1,345	1,436	1,486	1,547	1,638	1,690	1,741	1,844	1,990	2,120								
Water heat exchanger - evaporator	Type			Plate heat exchanger																				
	Water volume		l	19	22	29		35		41		49		62										
	Water flow rate	Nom.	l/s	8.3	9.5	10.7	11.9	13.4	15.2	17.3	19.6	21.9	24.5	27.3	29.9	32.4								
	Water pressure drop	Cooling	Nom.	kPa	25		20		25		22		29		36		45		44		52		62	
Compressor	Type			Scroll compressor																				
	Quantity			4																				
Sound power level	Cooling	Nom.	dB(A)	83	86	88	90	91			93		95			96								
Sound pressure level	Cooling	Nom.	dB(A)	65	68	70	72	74			73		76		77			78						
Operation range	Evaporator	Cooling	Min.~Max.	°CDB																				
	Condenser	Cooling	Min.~Max.	°CDB																				
Refrigerant	Type / GWP			R-410A / 2,087.5																				
	Circuits	Quantity		2																				
Piping connections	Evaporator water inlet/outlet (OD)			3"																				
Unit	Starting current	Max	A	263	320	333	388	403	456	484	597	626	785	822	860	898								
	Running current	Cooling	Nom.	A	78	84	90	102	114	128	141	161	176	199	223	246	269							
		Max	A	118	131	144	160	175	205	232	262	290	328	366	403	441								
Power supply	Phase/Frequency/Voltage		Hz/V	3~/50/400																				

Condenserless screw chiller, standard efficiency, standard sound

- › Compact design to allow **easy indoor installation or retrofit operations**
- › Daikin semi-hermetic single screw stepless compressor
- › **High energy efficiency both at full and part load conditions**
- › Chilled water temperatures **down to -10°C** on standard unit
- › Optimised for use with **R-134a**
- › MicroTech III controller with superior control logic and easy interface



Cooling only				EWLD-J-SS																																												
Cooling capacity	Nom.			kW	110	128	142	163	236	191	264	285	306	327	355	382	428	473	501	529																												
Power input	Cooling	Nom.			kW	31.2	38.4	43.8	50.4	66.0	56.0	75.3	87.4	94.0	100	106	111	122	132	141	150																											
Capacity control	Method			Stepless																																												
	Minimum capacity			%	25.0								12.5																																			
EER					3.51	3.33	3.25	3.24	3.58	3.42	3.51	3.26	3.25	3.35	3.43	3.52	3.59	3.55	3.52																													
Dimensions	Unit	Height			1,020								2,000																																			
		Width			913																																											
		Depth			2,684																																											
Weight	Unit			kg	1,124	1,141	1,237	1,263	1,489	1,305	1,489	2,474	2,500	2,526	2,568	2,611	2,795	2,979																														
	Operation weight			kg	1,138	1,159	1,253	1,281	1,518	1,327	1,518	2,505	2,533	2,562	2,608	2,655	2,845	3,036																														
Water heat exchanger - evaporator	Type			Plate heat exchanger																																												
	Water volume			l	14	18	14	17	26	20	26	29	31	33	37	41	46	52																														
	Water flow rate	Nom.			l/s	5.2	6.1	6.8	7.8	11.3	9.2	12.6	13.6	14.6	15.6	17.0	18.3	20.5	22.6	24.0	25.3																											
	Water pressure drop	Cooling	Nom.			kPa	14	13	39	37	26	33	32	39	37	34	33	29	26	29	32																											
Compressor	Type			Single screw compressor																																												
	Quantity			1								2																																				
Sound power level	Cooling	Nom.			89								94								96																											
Sound pressure level	Cooling	Nom.			79								82								83																											
Operation range	Evaporator	Cooling	Min.~Max.			-10~-15																																										
	Condenser	Cooling	Min.~Max.			25~60																																										
Refrigerant	Type / GWP			R-134a / 1,430																																												
	Circuits			1								2																																				
Piping connections	Evaporator water inlet/outlet (OD)			76.2 mm																																												
Unit	Maximum starting current			A	151				195				288				195				288				281				293				310				403				422				440			
	Nominal running current (RLA)	Cooling			A	52	62	72	81	107	91	120	145	153	162	171	181	197	214	227	241																											
	Maximum running current			A	76	97	107	122	167	143	189	215	230	245	265	286	311	335	357	378																												
Power supply	Phase/Frequency/Voltage					3~/50/400																																										

Condenserless screw chiller, standard efficiency, standard sound

- › Stepless single-screw compressor
- › Optimised for use with **R-134a**
- › **1-2 truly independent refrigerant circuits**
- › Standard electronic expansion valve
- › DX shell and tube evaporator – one pass refrigerant side for easy oil circulation and return
- › All models are PED pressure vessel approved
- › Partial heat recovery available
- › MicroTech III controller with superior control logic and easy interface



EWLD-G-SS

MicroTech III

Cooling only				EWLD-G-SS													
Cooling capacity		Nom.		160	190	240	280	320	360	380	420	480	550				
Power input	Cooling	Nom.		kW	46.2	55.3	66.9	75.7	92.3	101	110	122	133	151			
Capacity control	Method			Stepless													
	Minimum capacity			25.0				12.5									
EER				3.47	3.40	3.64	3.55	3.41	3.46	3.43	3.51	3.56	3.48				
Dimensions	Unit	Height		1,860				1,880				1,942					
		Width		1,000				1,100									
		Depth		3,700				4,400									
Weight	Unit			kg		1,280		1,398		2,442		2,446		2,501		2,506	
	Operation weight			kg		1,337		1,516		2,560				2,670			
Water heat exchanger - evaporator	Type			Single pass shell and tube													
	Water volume		l		60	56	123		118	113		173	168				
	Water flow rate	Nom.		l/s		7.7	9.0	11.6	12.9	15.1	16.8	18.2	20.4	22.7	25.1		
Compressor	Water pressure drop	Cooling	Nom.	kPa		42	58	40	49	55	54	63	48	49	59		
	Type			Single screw compressor													
Sound power level	Cooling		Nom.		88				90								
	Cooling		Nom.		70				72								
Operation range	Evaporator	Cooling	Min.~Max.		°CDB												
	Condenser	Cooling	Min.~Max.		°CDB												
Refrigerant	Type / GWP			R-134a / 1,430													
	Circuits		Quantity		1						2						
Piping connections	Evaporator water inlet/outlet (OD)			88.9mm				114.3mm				139.7mm					
Unit	Maximum starting current			A													
	Nominal running current (RLA)		Cooling		A		288		380		397		420		438		
	Maximum running current		A		79	90	107	120	157	169	181	197	213	240			
Power supply	Phase/Frequency/Voltage			Hz/V													
				3~/50/400													

Condenserless screw chiller, standard efficiency, standard sound

- › DX shell and tube evaporator – one pass refrigerant side for easy oil circulation and return
- › Stepless single-screw compressor
- › Standard electronic expansion valve
- › Optimised for use with R-134a



Cooling only				EWLD-I-SS	320	400	420	500	600	650	750	800	850	900	950	C10	C11	C12	C13	C14	C15	C16	C17	
Cooling capacity	Nom.			kW	315	374	437	509	607	670	740	802	865	935	975	1,029	1,097	1,144	1,210	1,278	1,330	1,381	1,433	
Power input	Cooling	Nom.		kW	80.3	96.0	113	134	160	175	192	208	224	246	264	283	286	302	318	336	356	375	395	
Capacity control	Method				Stepless																			
	Minimum capacity			%	25.0				12.5				8.3											
EER					3.93	3.89	3.88	3.79	3.80	3.82		3.86	3.81	3.69	3.64	3.83	3.79		3.80	3.74	3.68	3.63		
Dimensions	Unit	Height		mm	1,899				2,325				2,415											
		Width		mm	1,464								2,135											
		Depth		mm	3,114				4,391				4,426											
Weight	Unit			kg	1,861	1,869	1,884	3,331	3,339	3,347	3,356	3,364	3,412	5,146	5,167	5,188		5,208						
	Operation weight			kg	2,054	2,052	2,056	3,602	3,603	3,604	3,605	3,645	5,667	5,671	5,677		5,680							
Water heat exchanger - evaporator	Type				Single pass shell and tube																			
	Water volume			l	193	183	172	271	263	256	248	241	233	504	489	472	504	489	472					
	Water flow rate	Nom.		l/s	15.1	17.9	20.9	24.4	29.1	32.1	35.4	38.4	41.4	44.8	46.7	49.3	52.5	54.8	57.9	61.2	63.7	66.1	68.6	
Compressor	Water pressure drop	Cooling	Total	kPa	34	46	49	56	50	40	52	49	40	49	36	54	47	51	43	53	57	61	65	
	Type				Single screw compressor																			
	Quantity				1				2				3											
Sound power level	Cooling	Nom.		dB(A)	94	97				98	99	100				101	103							
Sound pressure level	Cooling	Nom.		dB(A)	75	76	78				79	80	81				80	81	83					
Operation range	Evaporator	Cooling	Min.~Max.	°CDB	-8~15																			
	Condenser	Cooling	Min.~Max.	°CDB	25~60																			
Refrigerant	Type / GWP				R-134a / 1,430																			
	Circuits	Quantity			1				2				3											
Piping connections	Evaporator water inlet/outlet (OD)				42mm																			
Unit	Maximum starting current			A	330	464				493	627	650	681				703	836	867	898	920	942		
	Nominal running current (RLA)	Cooling		A	131	157	181	214	260	287	313	338	361	391	420	448	470	493	517	542	571	601	631	
	Maximum running current			A	204	233	271	299	407	436	465	504	542	570	597	670	698	737	775	814	841	868	896	
Power supply	Phase/Frequency/Voltage			Hz/V	3~/50/400																			

Water cooled centrifugal chiller, high efficiency, standard sound

- › Totally oil-free operation resulting in reduced maintenance costs and increased reliability
- › An inverter driven compressor allows the capacity to be adjusted precisely to match variations in room and outside temperatures
- › Onboard digital electronics provide smart controls



Cooling only				EWWD-FZXS	320	430	520	640	860	C10		
Cooling capacity	Min.			kW	113	133	170	113	133	169		
	Max.			kW	316	439	520	639	887	1,054		
Power input	Cooling	Min.			kW	20.6	25.5	32.7	20.5	25.5	32.6	
		Max.			kW	65.1	90.4	106	129	179	208	
Capacity control	Method			Stepless								
EER				4.85	4.86	4.93	4.97	4.95	5.06			
ESEER				8.11	8.39	8.66	8.83	8.52	8.88			
IPLV				9.25	9.64	9.89	9.50	9.74	10.06			
Dimensions	Unit	Height			mm	1,823		1,755	1,748	1,794		
		Width			mm	1,276		1,790	1,853	1,904		
		Depth			mm	3,254		3,419	3,441	3,289	3,401	
Weight	Unit			kg	2,360	2,416	2,546	3,709	4,095	4,765		
	Operation weight				kg	2,520	2,634	2,812	4,074	4,548	5,330	
Water heat exchanger - evaporator	Type			Flooded shell and tube								
	Water volume					l	78	107	134	184	210	302
	Water flow rate	Nom.				l/s	15.1	21.0	24.9	30.6	42.4	50.4
	Water pressure drop	Cooling	Nom.				kPa	30	32	33	35	31
Water heat exchanger - condenser	Type			Flooded shell and tube								
	Water flow rate	Nom.				l/s	18.3	25.5	30.1	36.9	51.3	60.7
	Water pressure drop	Cooling	Nom.				kPa	24	26	29	23	32
Compressor	Type			Oil free centrifugal compressor								
	Quantity						1			2		
Sound power level	Cooling	Nom.				dB(A)	89	90	91	92	94	95
Sound pressure level	Cooling	Nom.				dB(A)	71	72	73	74	75	76
Operation range	Evaporator	Cooling	Min.-Max.				°CDB					
	Condenser	Cooling	Min.-Max.				°CDB					
Refrigerant	Type / GWP			R-134a / 1,430								
	Circuits	Quantity						1				
Refrigerant charge	Per circuit					kg	240.0	220.0	180.0	220.0	300.0	
						TCO _{2eq}	343.2	314.6	257.4	314.6	429.0	
Piping connections	Evaporator water inlet/outlet (OD)					168.3mm			219.1mm		273mm	
	Condenser water inlet/outlet (OD)					168.3mm			219.1mm		273mm	
Unit	Maximum starting current					A	2					
	Nominal running current (RLA)	Cooling				A	104	142	168	207	285	335
	Maximum running current					A	135	210	176	270	420	352
Power supply	Phase/Frequency/Voltage					Hz/V	3~/50/400					

Water cooled centrifugal chiller, high efficiency, standard sound

- > Optional Variable Frequency Drive (VFD) to improve the part load efficiency
- > High efficiency flooded type shell and tube evaporator/condensers
- > Lower equipment, installation and annual operating costs than two single compressor chillers (DWDC)
- > Main components can be removed or repaired without shutting down the unit as the chiller has two of everything (compressors, lubrication systems, control systems and starters) (DWDC)
- > Unloading to 5% (DWSC) or 10% (DWDC) of full load provides improved stability of the chilled water temperature and less harmful cycling of compressors
- > Single stage centrifugal compressor (DWSC)



DWSC-DWDC

MicroTech II

Cooling only		DWDC/DWSC	DWDC	DWSC
Cooling capacity	Min.	kW	600	300
	Max.	kW	9,000	4,500
Compressor	Type	Single stage centrifugal compressor		
Refrigerant	Type / GWP	R-134a / 1,430		
	Charge	kg	700 - 1,400	300 - 1,000
		TCO ₂ Eq	1,001 - 2,002	429 - 1,430

Options - Chillers

Options - Small chillers

Chiller series	Integrated hydronics		LWE			Electrical
	Single pump		High Glycol		Low Glycol	Evaporator heater tape
	OPSP		OPZH		OPZL	OP10
EWAQ-ADVVP	STD					STD
EWYQ-ADVVP	STD					STD
EWAQ-ACV3	STD					STD
EWAQ-ACW1	STD					STD
EWYQ-ACV3	STD					STD
EWYQ-ACW1	STD					STD
EWWP-KBW1N			Option		Option	
EWLP-KBW1N			Option		Option	

(1) Impossible option combination: OPZH+OPZL

Options - Medium and large chillers (Part 1)

Description	Code	EWAQ-BAW EWYQ-BAW	EWAQ-E-XS EWYQ-F-SS/XS	EWAQ-E- XL/XR EWAQ-F-SL/ SR/XL/XR	EWYQ-F-XS	EWYQ-F-XL	EWYQ-F-XR	EWAD-E-	EWAD-D-SS	EWAD-D-SL	EWAD-D-SR	EWAD-D-SX	EWAD-D-XS	EWAD-D-XR	EWAD-D-HS
Total heat recovery	01	-	-	-	-	-	-	Option	Option	Option	Option	Option	Option	Option	Option
Total heat recovery (1 circuit)	02	-	-	-	-	-	-	-	Option	Option	Option	Option	Option	Option	Option
Partial heat recovery	03	-	Option	Option	CF	CF	CF	Option	Option	Option	Option	Option	Option	Option	Option
Direct on line starter (DOL)	04	-	STD	STD	STD	STD	STD	-	-	-	-	-	-	-	-
Wye-Delta compressor starter (Y-D)	05	-	-	-	-	-	-	STD	STD	STD	STD	STD	STD	STD	STD
Soft starter	06	-	Option	Option	Option	Option	Option	Option	Option	Option	Option	Option	Option	Option	Option
Heat pump version	07	-	-	-	-	-	-	-	-	-	-	-	-	-	-
Heat pump version (including pursuit mode)	07a	-	-	-	-	-	-	-	-	-	-	-	-	-	-
Brine version (down -8°C)	08a (1)	-	-	-	-	-	-	-	-	-	-	-	-	-	-
Brine version (down -10°C)	08b (1)	Option	-	-	-	-	-	-	-	-	-	-	-	-	-
Brine version (down -15°C)	08c (1)	-	Option	Option	Option	Option	Option	Option	Option	Option	Option	Option	Option	Option	Option
Double setpoint	10	-	STD	STD	STD	STD	STD	STD	STD	STD	STD	STD	STD	STD	STD
Compressor thermal overload relays	11	-	Option	Option	Option	Option	Option	Option	Option	Option	Option	Option	Option	Option	Option
Fans thermal relays	12	-	-	-	-	-	-	-	-	-	-	-	-	-	-
Phase monitor	13	-	Option	Option	Option	Option	Option	STD	STD	STD	STD	STD	STD	STD	STD
Inverter compressor starter	14	-	-	-	-	-	-	-	Option(4)	Option(4)	Option(4)	Option(4)	Option(4)	Option(4)	Option(4)
Under / Over voltage control	15	-	Option	Option	Option	Option	Option	Option	Option	Option	Option	Option	Option	Option	Option
Energy meter	16	-	Option	Option	Option	Option	Option	Option	Option	Option	Option	Option	Option	Option	Option
Energy meter (including current limit)	16a	-	-	-	-	-	-	-	-	-	-	-	-	-	-
Capacitors for power factor correction	17	-	Option	Option	Option	Option	Option	Option	Option	Option	Option	Option	Option	Option	Option
Auxiliary relay	18	-	-	-	-	-	-	-	-	-	-	-	-	-	-
Current limit	19	-	-	-	-	-	-	Option	Option	Option	Option	Option	Option	Option	Option
Evaporator victaulic kit	20	-	STD	STD	STD	STD	STD	-	STD	-	-	STD	STD	STD	-
Evaporator flange kit	21	-	-	-	-	-	-	-	Option	-	-	Option	Option	Option	-
Evaporator marine waterbox victaulic (2 passes)	22	-	-	-	-	-	-	-	-	-	-	-	-	-	-
Evaporator marine waterbox victaulic (1 pass)	22a	-	-	-	-	-	-	-	-	-	-	-	-	-	-
Evaporator marine waterbox victaulic (3 passes)	23	-	-	-	-	-	-	-	-	-	-	-	-	-	-
Evaporator marine waterbox flanged (2 passes)	24	-	-	-	-	-	-	-	-	-	-	-	-	-	-
Evaporator marine waterbox flanged (1 pass)	24a	-	-	-	-	-	-	-	-	-	-	-	-	-	-
Evaporator marine waterbox flanged (3 passes)	25	-	-	-	-	-	-	-	-	-	-	-	-	-	-
Condenser double flanges kit	26	-	-	-	-	-	-	-	-	-	-	-	-	-	-
Evaporator water side design pressure (10 Bar)	27	-	-	-	-	-	-	-	STD	STD	STD	STD	STD	STD	STD
Evaporator water side design pressure (16 Bar)	28	-	-	-	-	-	-	-	-	-	-	-	-	-	-
20mm evaporator insulation	29	-	STD	STD	STD	STD	STD	Option	Option	STD	STD	Option	Option	Option	STD
Axial fans (100 Pa lift)	30	-	-	-	-	-	-	-	-	-	-	-	-	-	-
McQuiet	31	-	-	-	-	-	-	-	-	-	-	-	-	-	-
Axial fans (250 Pa lift)	32	-	CF	-	-	-	-	-	CF	CF	CF	CF	CF	CF	CF
20mm condenser insulation	33	-	-	-	-	-	-	-	-	-	-	-	-	-	-
Fan silent mode	34	-	-	-	-	-	-	-	-	-	-	-	-	-	-
Fans Speed Control Device (Phase Cut)	35	-	-	-	-	-	-	-	-	-	-	-	-	-	-
Condenser victaulic kit	36	-	-	-	-	-	-	-	-	-	-	-	-	-	-
Condenser flange kit	37	-	-	-	-	-	-	-	-	-	-	-	-	-	-
Condenser marine waterbox victaulic (2 passes)	38	-	-	-	-	-	-	-	-	-	-	-	-	-	-
Condenser marine waterbox victaulic (1 pass)	38a	-	-	-	-	-	-	-	-	-	-	-	-	-	-
Condenser marine waterbox victaulic (3 passes)	39	-	-	-	-	-	-	-	-	-	-	-	-	-	-
Condenser marine waterbox flanged (2 passes)	40	-	-	-	-	-	-	-	-	-	-	-	-	-	-
Condenser marine waterbox flanged (1 pass)	40a	-	-	-	-	-	-	-	-	-	-	-	-	-	-
Condenser marine waterbox flanged (3 passes)	41	-	-	-	-	-	-	-	-	-	-	-	-	-	-
Speedtrol (fan speed control device - ON/OFF - up to -18°C)	42	-	Option	Option	-	-	-	Option	Option	Option	Option	-	Option	Option	Option
Speedtrol (fan speed control device - ON/OFF - down to -10°C in cooling)	42a	-	-	-	Option	Option	-	-	-	-	-	-	-	-	-
Condenser coil guards	43	-	Option	Option	Option	Option	Option	Option	Option	Option	Option	Option	Option	Option	Option
Evaporator area guards	44	-	Option	Option	Option	Option	Option	-	-	-	-	-	-	-	-
Cu-Cu condenser coil	45	-	Option	Option	Option	Option	Option	Option	Option	Option	Option	Option	Option	Option	Option
Cu-Cu-Sn condenser coil	46	-	Option	Option	Option	Option	Option	Option	Option	Option	Option	Option	Option	Option	Option

Options - Medium and large chillers (Part 2)

Description	Code	EWAQ-BAW EWYQ-BAW	EWAQ-E-XS EWAQ-F-SS/XS	EWAQ-E-XL/XR EWAQ-F-SL/ XR/XL/XR	EWYQ-F-XS	EWYQ-F-XL	EWYQ-F-XR	EWAD-E-	EWAD-D-SS	EWAD-D-SL	EWAD-D-SR	EWAD-D-SX	EWAD-D-XS	EWAD-D-XR
Condenser water side design pressure (16 Bar)	47	-	-	-	-	-	-	-	-	-	-	-	-	-
Condenser water side design pressure (10 Bar)	47a	-	-	-	-	-	-	-	-	-	-	-	-	-
Alucoat fins coil	49	-	Option	Option	STD	STD	STD	Option	Option	Option	Option	Option	Option	Option
Cu-Ni 90-10 condenser tubes	50	-	-	-	-	-	-	-	-	-	-	-	-	-
Condenser 1 pass (ΔT 4-8 °C)	51	-	-	-	-	-	-	-	-	-	-	-	-	-
Condenser 2 passes (ΔT 4-8 °C)	52	-	-	-	-	-	-	-	-	-	-	-	-	-
Condenser 2 passes (ΔT 9-15 °C)	53	-	-	-	-	-	-	-	-	-	-	-	-	-
Condenser 4 passes	54	-	-	-	-	-	-	-	-	-	-	-	-	-
Water pressure differential switch on condenser	55	-	-	-	-	-	-	-	-	-	-	-	-	-
Water pressure differential switch on evaporator	56	-	-	-	-	-	-	-	-	STD	STD	-	-	-
Evaporator electric heater	57	Option	STD	STD	STD	STD	STD	STD	STD	STD	STD	STD	STD	STD
Evaporator flow switch	58	-	STD	STD	STD	STD	STD	Option	Option	Option	Option	Option	Option	Option
Condenser flow switch	59	-	-	-	-	-	-	-	-	-	-	-	-	-
Electronic expansion valve	60	-	STD	STD	STD	STD	STD	STD	STD	STD	STD	STD	STD	STD
Discharge line shut-off valve	61	-	Option	Option	Option	Option	Option	STD	STD	STD	STD	STD	STD	STD
Suction line shut-off valve	62	-	Option	Option	Option	Option	Option	STD	STD	STD	STD	STD	STD	STD
High pressure side manometers	63	-	Option	Option	Option	Option	Option	Option	Option	Option	Option	Option	Option	Option
Low pressure side manometers	64	-	Option	Option	Option	Option	Option	Option	Option	Option	Option	Option	Option	Option
Ambient outside temperature sensor and setpoint reset	67	-	STD	STD	STD	STD	STD	STD	STD	STD	STD	STD	STD	STD
Hour run meter	68	-	STD	STD	STD	STD	STD	STD	STD	STD	STD	STD	STD	STD
General fault contactor	69	-	STD	STD	STD	STD	STD	STD	STD	STD	STD	STD	STD	STD
Container Kit	71	-	Option	Option	Option	Option	Option	Option	Option	Option	Option	Option	Option	Option
Rubber anti vibration mounts	75	-	Option	Option	Option	Option	Option	Option	Option	Option	Option	Option	Option	Option
Sound proof system	76	-	-	-	-	-	-	-	-	-	-	-	-	-
Sound proof system (integral)	76-a	-	-	-	-	-	-	-	-	-	-	-	-	-
Sound proof system (compressor)	76-b	-	-	-	-	-	-	-	-	-	-	-	-	-
Spring anti vibration mounts	77	-	Option	Option	Option	Option	Option	Option	Option	Option	Option	Option	Option	Option
One centrifugal pump (low lift)	78	Option	-	-	-	-	-	Option	-	-	-	-	-	-
One centrifugal pump --- SPK1	78-a	-	Option	Option	Option	Option	Option	-	-	Option	Option	-	-	-
One centrifugal pump --- SPK2	78-b	-	Option	Option	Option	Option	Option	-	-	Option	Option	-	-	-
One centrifugal pump --- SPK3	78-c	-	Option	Option	Option	Option	Option	-	-	Option	Option	-	-	-
One centrifugal pump --- SPK4	78-d	-	Option	Option	Option	Option	Option	-	-	Option	Option	-	-	-
One centrifugal pump --- SPK5	78-e	-	-	-	-	-	-	-	Option	-	-	-	Option	Option
One centrifugal pump --- SPK6	78-f	-	-	-	-	-	-	-	Option	-	-	-	Option	Option
One centrifugal pump --- SPK7	78-g	-	-	-	-	-	-	-	Option	-	-	-	Option	Option
One centrifugal pump --- SPK8	78-h	-	-	-	-	-	-	-	Option	-	-	-	Option	Option
One centrifugal pump --- SPK9	78-i	-	-	-	-	-	-	-	-	-	-	-	Option	-
One centrifugal pump --- SPK10	78-j	-	-	-	-	-	-	-	-	-	-	-	Option	-
One centrifugal pump --- SPK1a	78-l	-	-	-	Option	Option	Option	-	-	-	-	-	-	-
One centrifugal pump --- SPK1b	78-m	-	-	-	Option	Option	Option	-	-	-	-	-	-	-
One centrifugal pump --- SPK1c	78-n	-	-	-	Option	Option	Option	-	-	-	-	-	-	-
One centrifugal pump (high lift)	79	Option	-	-	-	-	-	Option	-	-	-	-	-	-
Two centrifugal pump (low lift)	80	-	-	-	-	-	-	-	-	-	-	-	-	-
Two centrifugal pump --- DPK1	80-a	-	-	-	-	-	-	-	-	Option	Option	-	-	-
Two centrifugal pump --- DPK2	80-b	-	-	-	-	-	-	-	-	Option	Option	-	-	-
Two centrifugal pump --- DPK3	80-c	-	-	-	-	-	-	-	-	Option	Option	-	-	-
Two centrifugal pump --- DPK4	80-d	-	-	-	-	-	-	-	-	Option	Option	-	-	-
Two centrifugal pump --- DPK5	80-e	-	-	-	-	-	-	-	Option	-	-	-	Option	Option
Two centrifugal pump --- DPK6	80-f	-	-	-	-	-	-	-	Option	-	-	-	Option	Option
Two centrifugal pump --- DPK7	80-g	-	-	-	-	-	-	-	Option	-	-	-	Option	Option
Two centrifugal pump --- DPK8	80-h	-	-	-	-	-	-	-	Option	-	-	-	Option	Option
Two centrifugal pump (high lift)	81	-	-	-	-	-	-	-	-	-	-	-	-	-
Witness test	82	-	-	-	-	-	-	-	-	-	-	-	-	-
External tank without cabinet (500 L)	83 (3)	-	Option	Option	Option	Option	Option	Option	Option	Option	Option	Option	Option	Option
External tank without cabinet (1000 L)	84 (3)	-	Option	Option	Option	Option	Option	Option	Option	Option	Option	Option	Option	Option
External Tank (500 L) With CABINET RAL 7042	85	-	-	-	-	-	-	-	-	-	-	-	-	-
External Tank (1000 L) With CABINET RAL 7042	86	-	-	-	-	-	-	-	-	-	-	-	-	-
External tank with cabinet (500 L)	87 (3)	-	Option	Option	Option	Option	Option	Option	Option	Option	Option	Option	Option	Option
External tank with cabinet (1000 L)	88 (3)	-	Option	Option	Option	Option	Option	Option	Option	Option	Option	Option	Option	Option
Acoustic test	89	-	-	-	-	-	-	-	-	-	-	-	-	-
Setpoint reset, Demand limit and Alarm from external device	90	-	Option	Option	Option	Option	Option	STD	STD	STD	STD	STD	STD	STD
Double pressure relief valve with diverter	91	-	Option	Option	Option	Option	Option	Option	Option	Option	Option	Option	Option	Option
PW COMPRESSOR - PART WINDING START	92	-	-	-	-	-	-	-	-	-	-	-	-	-
Low ambient kit for 1 circuit	93	-	-	-	-	-	-	-	-	-	-	-	-	-
Low ambient kit for 2 circuits	94	-	-	-	-	-	-	-	-	-	-	-	-	-
Compressors circuit breakers	95	-	Option	Option	Option	Option	Option	Option	Option	Option	Option	Option	Option	Option
Fans circuit breakers	96	-	Option	Option	Option	Option	Option	STD	STD	STD	STD	STD	STD	STD
Main switch interlock door	97	-	STD	STD	STD	STD	STD	STD	STD	STD	STD	STD	STD	STD
Emergency stop	98	-	-	-	-	-	-	-	-	-	-	-	-	-
Fans speed regulation (+ fan silent mode)	99 (2)	-	Option	Option	-	-	-	Option	Option	Option	Option	STD	Option	Option
Fans speed regulation (inverter)	99a (2)	-	-	-	Option	Option	STD	-	-	-	-	-	-	-
Refrigerant recovery unit	100	-	-	-	-	-	-	-	-	-	-	-	-	-
Evaporator right water connections	101	-	-	-	-	-	-	-	SO	SO	SO	SO	SO	SO
Ground fault relay	102	-	Option	Option	Option	Option	Option	-	-	-	-	-	-	-
Evaporator 1 pass	103	-	-	-	-	-	-	-	-	-	-	-	-	-
Evaporator 2 passes	103a	-	-	-	-	-	-	-	-	-	-	-	-	-
Evaporator double flange kit	104	-	-	-	-	-	-	-	-	-	-	-	-	-
Liquid receiver	105	-	-	-	-	-	-	-	-	-	-	-	-	-
Evaporator right water connections	106	-	-	-	-	-	-	-	-	-	-	-	-	-
Rapid restart	110	-	-	-	-	-	-	-	-	-	-	-	-	-
High temperature kit	111	-	-	-	-	-	-	-	-	-	-	-	-	-
Transport kit	112	-	Option	Option	Option	Option	-	Option	Option	Option	Option	Option	Option	Option
Optimized free cooling (VFD fans regulation)	113-a	-	-	-	-	-	-	-	-	-	-	-	-	-
Optimized free cooling (On/Off fans)	113-b	-	-	-	-	-	-	-	-	-	-	-	-	-
Nordic kit	114	-	-	-	Option	Option	Option	-	-	-	-	-	-	-
Water filter	115	-	STD	STD	STD	STD	STD	-	-	-	-	-	-	-
Condenser coil protection panels	116	-	Option	Option	Option	Option	Option	Option	Option	Option	Option	Option	Option	Option
Blygold coil treatment	117	-	Option	Option	Option	Option	Option	Option	Option	Option	Option	Option	Option	Option
Inverter kit for pump (SPK1-SPK6)	120a	-	-	-	-	-	-	-	-	-	-	-	-	-
Inverter kit for pump (SPK7-SPK10)	120b	-	-	-	-	-	-	-	-	-	-	-	-	-
Inverter kit for pumps (DPK2-DPK6)	120c	-	-	-	-	-	-	-	-	-	-	-	-	-
Inverter kit for pumps (DPK7-DPK10)	120d	-	-	-	-	-	-	-	-	-	-	-	-	-
Refrigerant leak detection	121	-	-	-	-	-	-	-	-	-	-	-	-	-

(1) Option 08 includes option 29 - (2) Option 99(a) includes 'Fan overload protection' - (3) Piping between the inertial tank and the unit is not included. Electric heater power supply has to be provided from external source - (4) The order of inverter compressor will have an impact on the delivery time: please contact the factory - (5) Unit performance will be affected; contact factory for information. It is mandatory to order the option 26 when selecting CU-Ni 90-10 condenser tubes - (6) Sound proof system - compressor enclosure - (7) Compressor enclosure - (8) Soundproof cabinet will be supplied in a separate kit and not assembled. For better performance the cabinet will be integral kind (around the whole chiller, not only around compressors). Cabinet assembly is not included in the supply (9) Special transport is required (flat rack truck and open top when option 01 is selected) for model sizes as follows: EWWD121-SS - EWWD181-SS (10) Forklift loading-unloading operations are not allowed when option 01

Accessories - Chillers

Panels	Air-cooled chillers							
	EWA/YQ-BA SEHVX+SERHQ	EWAQ-E- EWA/YQ-F-	EWYD~BZ	EWAQ~GZ	EWAD~E- ERAD~E-	EWAD~D-	EWAD~C-	EWAD~CZ
EKDSSP*** (a) Serial Sequencing Panel			•					
EKDSSP-S*** Serial Sequencing Panel (Siemens)		•		•	•	•	•	•
EKDDSP Digital Sequencing Panel		•	•	•	•	•	•	•
EKPWPRO PlantWatchPRO monitoring system			•					
EKPWPROM PlantWatchPRO monitoring system (modem & webserver included)			•					

Serial Cards & Communication Modules	Air-cooled chillers							
	EWAQ~BA EWYQ~BA	EWAQ-E- EWA/YQ-F-	EWYD~BZ	EWAQ~GZ	EWAD~E- ERAD~E-	EWAD~D-	EWAD~C-	EWAD~CZ
EKAC200J Serial Card RS485/Modbus			•					
EKACBAC Ethernet Card BACnet			•					
EKACLONP Serial Card LON FTT 10			•					
EKACRS232 Serial Card RS232 Modem Interface (single unit only)			•					
EKACWEB Web Server Card			•					
EKACBACMSTP Serial Card BACnet MSTP			•					
EKACBACCERT Serial Card BACnet pre-loaded (centrifugal chillers)								
EKMBDXA7V1 ModBus Interface DIII	•							
EKCM200J ModBus RTU communication module		•		•	•	•	•	•
EKCLMLON LON communication module		•		•	•	•	•	•
EKCMBACMSTP BACnet/MSTP communication module		•		•	•	•	•	•
EKCMBACIP BACnet/IP communication module		•		•	•	•	•	•

Other Systems & Accessories	Air-cooled chillers							
	EWAQ~BA EWYQ~BA	EWAQ-E- EWA/YQ-F-	EWYD~BZ	EWAQ~GZ	EWAD~E- ERAD~E-	EWAD~D-	EWAD~C-	EWAD~CZ
EKCON Converter RS485 to RS232			•					
EKCONUSB Converter RS485 to USB			•					
EKMODEM Fixed modem			•					
EKGSMOD GSM modem			•					
EKRUPCJ Remote display kit			•					
EKRUPCS Local/remote display HMI		•		•	•	•	•	•
EKPWPPOEXT PlantWatchPro I/O extension module for hardwiring and retrofit			•					
EKGWWEB Gateway web (Ethernet LAN SNMP)			•					
EKAC10C (c) Address card for connection to BMS or Remote user interface								
EKRUMCA (b) Remote installed user interface								
EHMC* Hydraulic module								
EKLS1 Low noise kit - 014 version								
EKLS2 Low noise kit - 022-195 version								
ECB2MUAW Controller kit (for modular units)								
ECB3MUAW Controller kit (for modular units)								
EKRPIAHT Digital input/output PCB	•							
EKRUAHTB Remote user interface	•							
DTA104A62 External control adapter	•							
BHGP26A1 Digital pressure gauge kit	•							
RTD-W BMS integration	•							
EKCC8-W Universal centralised controller	•							

Notes:

- (a) Serial Sequencing Panel working in cooling mode only with EWYD~BZ and EWYQ~F-ranges
- (b) To install EKRUMCA -> EKAC10C needs to be installed
- (c) EKAC10C allows direct connection to MODBUS BMS system

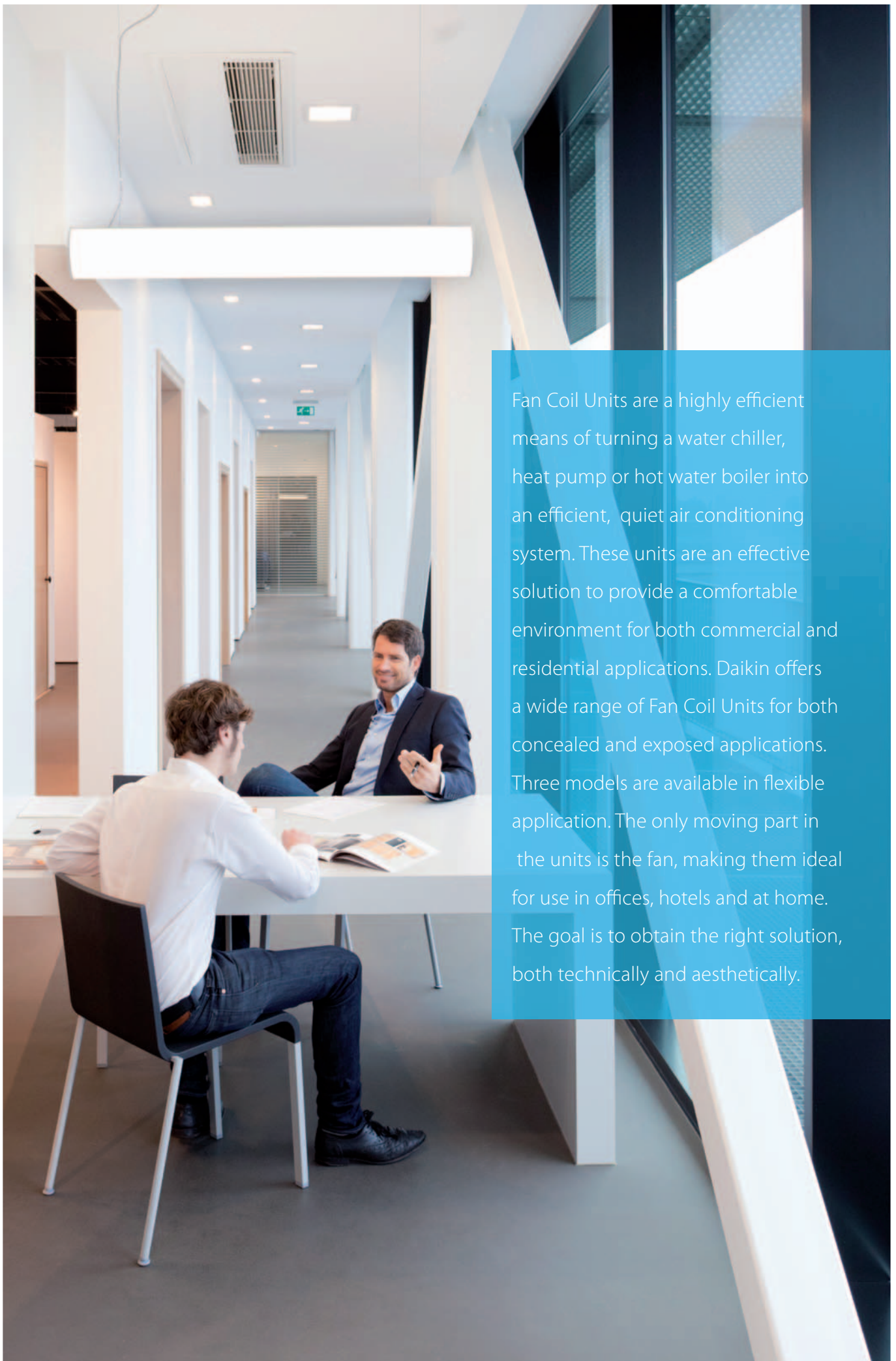

Fan Coil Units are a highly efficient means of turning a water chiller, heat pump or hot water boiler into an efficient, quiet air conditioning system. These units are an effective solution to provide a comfortable environment for both commercial and residential applications. Daikin offers a wide range of Fan Coil Units for both concealed and exposed applications. Three models are available in flexible application. The only moving part in the units is the fan, making them ideal for use in offices, hotels and at home. The goal is to obtain the right solution, both technically and aesthetically.

Fan coil units

Why choose Daikin fan coil units? 408

Products overview 410

Cassette units	412	
FWG-AT/AF	412	
FWC-BT/BF	413	
FWF-BT/BF	414	
FWF-CT	415	
Floor standing unit	416	
FWZ-AT/AF	416	
FWV-DAT/DAF	417	
Flexi type units	418	
FWR-AT/AF	418	
FWL-DAT/DAF	419	
FWS-AT/AF	420	
FWM-DAT/DAF	421	
Wall mounted unit	422	
FWT-CT	422	
Concealed ceiling units	423	
FWE-CT/CF	423	low ESP
FWB-BT	424	medium ESP
FWP-AT	425	medium ESP
FWD-AT/AF	426	high ESP

Options & accessories 428



Fan coil units with BLDC motor

As more buildings undergo renovation, the need to be able to deliver high indoor air quality in a specific space in an **efficient and cost-effective way** without having to do a radical re-fit of the entire HVAC system has made fan coil technology an obvious solution.

Daikin has a full capacity range of **aesthetically pleasing** fan coil units with advanced controls that reliably deliver **excellent comfort levels**. And by using a refined range of advanced DC fan motors, we are able to offer flexibility while maintaining very low noise levels.

Why choose Daikin fan coil units?

- The new brushless DC ranges reflect Daikin's commitment to developing highly efficient fan coil units that help to reduce energy consumption, without compromising on reliability and performance.
- High level quality is written large for us and we are pleased to offer high technology solutions to the market.

Benefits for the installer

- › Reduced amount of sizes: less stock space needed
- › Modular designs for multiple configurations
- › Easy integration in BMS system via modbus protocol

Benefits for the consultant

- › Best solution in the market in order to have top efficiency, best comfort and lowest sound levels

Benefits for the end user

- › High comfort level
- › Up to 70% savings on running costs
- › Controller with timer programmed operating mode
- › FWECSA controller that can satisfy all customer requirements in terms of FCU management

Fan coil unit software

Select your unit via our selection software

- › Selection logic is based on cooling and/or heating mode conditions the user enters.
- › User can indicate cooling mode and/or heating mode conditions and list available fan coil units.
- › A detailed report including technical specifications and wiring diagram can be printed.

www.daikineurope.com/support-and-manuals/software-downloads/applied-systems/index.jsp

Payback tool

Prove quickly the saving in electric cost using the new BLDC motor technology instead of the AC motor technology via our payback tool available on our Extranet.

BLDC fan motors - Video

Learn more on the advantages of BLDC fan motors in Fan coil units:



Check on
You Tube

www.youtube.com/DaikinEurope



Higher efficiency than AC (Alternative Current) motor

- › Up to 70% energy savings
- › No heat generation
- › No power losses
- › Higher efficiency than AC motors to reach set point

High comfort level

- › Less fluctuation of air temperature and relative humidity
- › More consistent output level
- › Stepless speed change for gradual air output
- › More accurate adjustments to reach set point

Low sound levels

- › Lower minimum rotation speed
- › No start-stop sequence
- › Gradual air output

High flexibility level

- › Multiple configurations: cassettes, floorstanding units, flexi type units with or without cabinet and ducted units
- › Wide capacity range in heating and cooling
- › Different piping topologies and connection valves



FWG-AT/AF



FWR-AT/AF



FWS-AT/AF



FWC-BT/BF

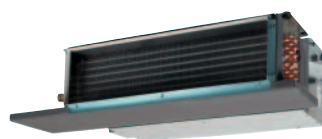

FWP-AT



FWZ-AT/AF

Product overview

Type	Model	Product name	Fan motor type
Ceiling mounted cassette	4-way blow ceiling mounted cassette - Brushless DC fan motor unit for ceiling mounting - High efficiency, continuous air flow regulation and fan speed modulation - Reduced sound emissions - Easy installation and maintenance	FWG-AT/AF	BLDC
	Round flow cassette - Brushless DC fan motor unit for ceiling mounting - 360° air discharge ensures uniform air flow - Integrated fresh air intake - Easy installation in corners - Standard drain pump with 850 mm lift	FWC-BT/BF	BLDC
	4-way blow ceiling mounted cassette - AC fan motor unit for ceiling mounting - Integrated fresh air intake - Horizontal auto swing - Easy installation in corners - Standard drain pump with 750 mm lift	FWF-BT/BF	AC
	4-way blow ceiling mounted cassette - AC fan motor unit for ceiling mounting - Easy installation and maintenance - High power air flow - Standard drain pump with 700 mm lift	FWF-CT	AC
Floor standing unit	Floor standing unit - Brushless DC fan motor for vertical mounting - Continuous air flow regulation and fan speed modulation - Up to 70% energy savings - Low sound levels	FWZ-AT/AF	BLDC
	Floor standing unit - AC fan motor unit for horizontal or vertical concealed mounting - Insulated valve packages, no extra drain pan required - Fast-on connections for electrical options: no tools needed - Easy maintenance	FWV-DAT/DAF	AC
Flexi type unit	Flexi type unit - Brushless DC fan motor unit for horizontal or vertical mounting - Continuous air flow regulation and fan speed modulation - Up to 70% energy savings - Low sound levels	FWR-AT/AF	BLDC
	Flexi type unit - AC fan motor unit for horizontal or vertical concealed mounting - Insulated valve packages, no extra drain pan required - Fast-on connections for electrical options: no tools needed - Easy maintenance	FWL-DAT/DAF	AC
	Concealed flexi type unit - Brushless DC fan motor unit for horizontal or vertical concealed mounting - Continuous air flow regulation and fan speed modulation - Up to 70% energy savings - Low sound levels	FWS-AT/AF	BLDC
	Concealed flexi type unit - AC fan motor unit for horizontal or vertical concealed mounting - Insulated valve packages, no extra drain pan required - Fast-on connections for electrical options: no tools needed - Easy maintenance	FWM-DAT/DAF	AC
Wall mounted unit	Wall mounted unit - AC fan motor unit for wall mounting - High aesthetic cabinet design - Optimum air distribution - Easy installation - 3-speed fan motor	FWT-CT	AC
Concealed ceiling unit	Concealed ceiling unit with low ESP - AC fan motor unit for horizontal concealed mounting - Available static pressure up to 50 Pa - Easy installation and maintenance - 4-speed fan motor - High power air flow	FWE-CT/CF	AC
	Concealed ceiling unit with medium ESP - Brushless DC fan motor unit for horizontal concealed mounting - Instant adjustment to temperature and relative humidity changes - Available static pressure up to 80 Pa - Low sound levels	FWP-AT	BLDC
	Concealed ceiling unit with medium ESP - AC fan motor unit for horizontal concealed mounting - Available static pressure up to 80 Pa - 7-speed electrical motors (thermal protection on windings) - Easy maintenance	FWB-BT	AC
	Concealed ceiling unit with high ESP - AC fan motor unit for horizontal or vertical concealed mounting - Available static pressure up to 120 Pa - Easy maintenance	FWD-AT/AF	AC

Capacity class (kW)

Capacity	1	2	3	4	5	6	7	8	9	10	11	12~	18
Cooling: 5.8~ 8.7 kW Heating: 7.5 ~ 12.1 kW					•			•			•		
Cooling: 2.0 - 5.2 kW Heating: 2.9 - 6.7 kW						•	•	•	•				
Cooling: 2.49 - 4.54 kW Heating: 3.52 - 5.28 kW		•	•	•	•								
Cooling: 2.64 - 10.08 kW Heating: 2.46 - 11.18 kW		•	•	•									
Cooling: 2.64 - 10.08 kW Heating: 2.46 - 11.18 kW		•	•			•		•					
Cooling: 1.46 - 8.02 kW Heating: 1.90 - 10.03 kW	•	•	•	•			•		•		•		
Cooling: 2.64 - 10.08 kW Heating: 2.46 - 11.18 kW		•	•			•		•					
Cooling: 1.46 - 8.02 kW Heating: 1.90 - 10.03 kW	•	•	•	•		•		•		•			
Cooling: 2.64 - 10.08 kW Heating: 2.46 - 11.18 kW		•	•			•		•					
Cooling: 1.46 - 8.02 kW Heating: 1.90 - 10.03 kW	•	•	•	•		•		•		•			
Cooling: 2.43 - 5.28 kW Heating: 3.22 - 7.33 kW		•	•	•	•	•							
Cooling: 2.10 - 9.96 kW Heating: 2.3 - 13.00 kW		•	•	•		•	•	•		•			
Cooling: 2.61 - 6.47 kW Heating: 5.47 - 12.28 kW		•	•	•	•	•	•						
Cooling: 2.61 - 10.34 kW Heating: 5.47 - 18.78 kW		•	•	•	•	•	•	•	•	•			
Cooling: 3.90 - 18.30 kW Heating: 4.05 - 21.92 kW				•		•		•		•		•	•

4-way blow ceiling mounted cassette

BLDC fan motor unit for ceiling mounting. High efficiency, continuous air flow regulation and fan speed modulation

- › Up to 70% **energy savings** with brushless DC motor technology compared to traditional technology
- › Instant adjustment to temperature and relative humidity changes
- › Continuous modulation of fan speed resulting in **reduced sound emissions**, in comparison with fixed speed AC motor fan coil units
- › **Easy installation and maintenance**



FWG-AT/AF				05	08	11	05	08	11
				2-pipe			4-pipe		
Cooling capacity	Total capacity	High	kW	5.90	8.80	11.75	4.40	7.20	9.00
		Medium	kW	4.65	7.25	9.70	3.60	6.10	7.75
		Low	kW	3.50	5.80	7.85	2.80	5.00	6.50
		Quiet	kW	2.40	4.55	6.15	2.00	3.90	5.20
	Sensible capacity	High	kW	4.51	6.43	8.37	3.85	5.75	7.17
		Medium	kW	3.44	5.41	6.97	2.99	4.85	6.06
		Low	kW	2.54	4.26	5.54	2.24	3.81	4.90
		Quiet	kW	1.71	3.22	4.27	1.56	2.91	3.89
Heating capacity	2-Pipe	High	kW	7.10	11.20	13.70	-	-	-
		Low	kW	4.45	7.00	9.25	-	-	-
		Quiet	kW	3.30	5.40	7.05	-	-	-
	4-Pipe	High	kW	-	-	-	7.65	11.20	15.65
		Low	kW	-	-	-	5.05	8.00	11.45
		Quiet	kW	-	-	-	3.75	6.40	9.35
Dimensions	Unit	Height	mm	265		300	265		300
		Width	mm	820					
		Depth	mm	820					
Weight	Unit		kg	26	28	32	26	28	32
Heat exchanger	Water volume		l	1.36	1.97	2.35	1.36	1.97	2.35
Water pressure drop	Cooling	High	kPa	24	20	41	18	19	32
	Heating	High	kPa	21	18	37	22	32	52
Fan	Type			Direct drive turbo fan					
	Air flow rate	High	m ³ /h	1,053	1,512	1,801	1,053	1,512	1,801
		Low	m ³ /h	595	951	1,155	595	951	1,155
Sound power level	High		dBA	46	57	59	46	57	59
	Quiet		dBA	30	40	43	30	40	43
Sound pressure level	High		dBA	37	47	51	37	47	51
Piping connections	Drain	OD	mm	19.05					
Power supply	Phase/Frequency/Voltage		Hz/V	1~/50/220-240					
Control systems	Infrared remote control			included with decoration panel					
	Wired remote control			BRC51A61					



Round flow cassette

BLDC fan motor unit for ceiling mounting. 360° air discharge

- › 360° air discharge ensures **uniform air flow** and temperature distribution
- › Modern style decoration panel in white (RAL9010)
- › **Fresh air intake integrated** in the same system thus reducing installation cost as no additional ventilation is required
- › Comfortable horizontal air discharge ensures **draughtfree operation** and prevents ceiling soiling
- › Possibility to shut 1 or 2 flaps for **easy installation in corners**

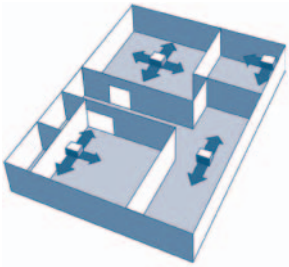

- › Standard drain pump with 850mm lift increases flexibility and installation speed

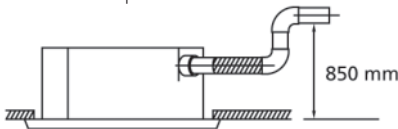

FWC-BT/BF				06	07	08	09	06	07	08	09
				2-pipe				4-pipe			
Cooling capacity	Total capacity	Super high	kW	5.8	6.8	7.7	8.7	5.8	6.6	7.6	8.7
		High	kW	5.0	5.6	6.3	7.2	4.9	5.6	6.3	7.2
		Low	kW	4.1	4.7	4.9	5.7	4.0	4.6	4.8	5.7
	Sensible capacity	Super high	kW	4.1	4.7	5.6	6.5	4.1	4.7	5.6	6.5
		High	kW	3.4	4.0	4.5	5.3	3.4	3.9	4.4	5.2
		Low	kW	2.8	3.3	3.5	4.1	2.7	3.2	3.4	4.0
Heating capacity	2-Pipe	Super high	kW	8.0	8.9	10.6	12.1	-			
		High	kW	6.3	7.1	8.3	9.5	-			
		Low	kW	5.5	5.9	6.9	7.8	-			
	4-Pipe	Super high	kW	-				7.5	8.4	9.7	11.0
		High	kW	-				6.2	6.8	7.8	8.8
		Low	kW	-				5.5	5.9	6.7	7.8
Power input	Super high	W	45	54	77	107	46	55	77	107	
	High	W	40	46	58	76	41	47	59	77	
	Low	W	34	37	39	45	35	38	40	46	
Dimensions	Unit	Height	mm	288							
		Width	mm	840							
		Depth	mm	840							
Weight	Unit	kg	26				29				
Fan	Type	Turbo fan									
	Quantity	1									
	Air flow rate	High	m ³ /h	1,062	1,236	1,518	1,776	1,032	1,200	1,476	1,746
	Low	m ³ /h	720	840	888	1,044	684	804	852	1,014	
Sound power level	Super high	dBA	43	47	53	57	43	47	53	57	
	High	dBA	36	39	44	49	36	39	44	49	
Sound pressure level	Super high	dBA	29	33	39	43	29	33	39	43	
	High	dBA	24	28	32	37	24	28	32	37	
Piping connections	Drain	OD	mm								
			VP25 (External dia.32 / internal dia. 25)								
Power supply	Phase/Frequency/Voltage	Hz/V	1~/50/220-240								
Control systems	Infrared remote control	BRC7E532F / BRC7E533F									
	Wired remote control	BRC315D7									

4-way blow ceiling mounted cassette

AC fan motor unit for ceiling mounting.
Possibility to shut 1 or 2 flaps

- > Modern style decoration panel in white (RAL9010)
- > Compact casing enables unit to fit flush into ceilings and match standard architectural modules
- > Comfortable horizontal auto swing ensures **draughtfree operation** and prevents ceiling soiling
- > **Fresh air intake integrated** in the same system thus reducing installation cost as no additional ventilation is required
- > Standard drain pump with **750mm lift**

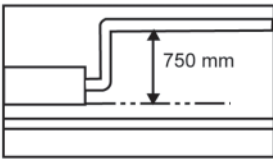

FWF-BT/BF				02	03	04	05	02	03	04	05
				2-pipe				4-pipe			
Cooling capacity	Total capacity	Super high	kW	2.0	3.2	4.2	5.2	2.0	2.7	3.5	4.5
		High	kW	1.7	2.8	3.3	4.0	1.7	2.3	2.8	3.5
		Low	kW	1.5	2.5	2.9	2.9	1.4	1.8	2.6	2.6
	Sensible capacity	Super high	kW	1.5	2.0	2.8	3.5	1.5	1.7	2.4	3.3
		High	kW	1.3	1.7	2.1	2.7	1.3	1.7	1.7	2.3
		Low	kW	1.1	1.4	1.8	1.8	1.1	1.0	1.5	1.5
Heating capacity	2-Pipe	Super high	kW	2.9	4.0	5.4	6.7	-	-	-	-
		High	kW	2.6	3.4	4.1	5.3	-	-	-	-
		Low	kW	2.3	2.8	3.6	3.6	-	-	-	-
	4-Pipe	Super high	kW	-	-	-	-	3.9	3.8	4.9	6.1
		High	kW	-	-	-	-	3.1	3.3	3.9	4.8
		Low	kW	-	-	-	-	2.3	2.8	3.5	3.5
Power input	Super high	W	74	90	118	118	74	94	121	121	
	High	W	67	70	89	89	67	62	74	93	
	Low	W	60	55	62	62	60	55	66	66	
Dimensions	Unit	Height	mm	285							
		Width	mm	575							
		Depth	mm	575							
Weight	Unit	kg	19				20				
Fan	Type	Turbo fan									
	Quantity	1									
	Air flow rate	High	m³/h	468	660	876	468	438	618	822	
	Low	m³/h	318				300				
Sound power level	Super high	dBA	44	50	55	44	46	52	57		
	High	dBA	40	44	49	40	42	46	51		
Sound pressure level	Super high	dBA	31	40	45	31	33	42	47		
	High	dBA	27	33	39	27	29	35	41		
Piping connections	Drain	OD	VP20 (External dia.26 / Internal dia. 20)								
Power supply	Phase/Frequency/Voltage	Hz/V	1~/50/220-440								
Control systems	Infrared remote control	BRC7E530 / BRC7E531									
	Wired remote control	BRC315D7									

4-way blow ceiling mounted cassette

AC fan motor unit for ceiling mounting

- › 4 way air discharge and air swing
- › Compact casing enables unit to fit flush into ceilings and match standard architectural modules
- › **Air suction from underneath**
- › Easy installation and maintenance
- › Built-in high pressure drain pump with **700mm lift**
- › Double-intake centrifugal fans
- › High power air flow
- › 3-speed fan motor



FWF-CT				02	03	04
				2-pipe		
Cooling capacity	Total capacity	High	kW	2.49	4.10	4.54
		Low	kW	1.91	2.78	3.37
	Sensible capacity	High	kW	1.91	2.93	3.37
		Low	kW	1.49	1.88	2.43
Heating capacity	2-Pipe	High	kW	3.52	4.69	5.28
		Low	kW	2.64	3.08	3.81
Power input	High		W	63	64	79
	Low		W	45	52	69
Dimensions	Unit	Height	mm	250		
		Width	mm	570		
		Depth	mm	570		
Weight	Unit		kg	22	23	
	Operation weight		kg	22	23	
Fan	Type	Direct drive turbo fan				
	Quantity	1				
	Air flow rate	High	m ³ /h	646	680	748
Low		m ³ /h	391	374	476	
Sound power level	High		dBA	52	54	56
Sound pressure level	High		dBA	42	45	48
Piping connections	Drain	OD	mm	19.05		
Water connections	Std. heat exchanger		inch	3/4		
Power supply	Phase/Frequency/Voltage		Hz/V	1~/50/220-440		
Current input	High		A	0.27	0.28	0.34
	Medium		A	0.22	0.25	0.31
	Low		A	0.19	0.22	0.35
Control systems	Infrared remote control	included with decoration panel				
	Wired remote control	MERCA/SRC-HPA				

Floor standing unit

BLDC fan motor unit for vertical mounting. Continuous air flow regulation and fan speed modulation

- › Up to 70% **energy savings** with brushless DC motor technology compared to traditional technology
- › **Instant adjustment** to temperature and relative humidity changes
- › **Low operating sound level**
- › Highly flexible solutions: multiple sizes, piping topologies and connection valves
- › Requires **very little installation space**



FWZ-AT/AF				02	03	06	08	02	03	06	08	
				2-pipe				4-pipe				
Cooling capacity	Total capacity	Min.	kW	0.61	0.88	1.19	1.79	0.60	0.88	1.19	1.79	
		Max.	kW	2.64	4.96	6.32	10.08	2.64	4.96	6.32	10.08	
	Sensible capacity	Min.	kW	0.41	0.58	0.79	1.20	0.40	0.58	0.79	1.20	
		Max.	kW	1.95	3.60	4.80	7.43	1.95	3.60	4.80	7.43	
Heating capacity	2-Pipe	Min.	kW	0.69	0.95	1.29	1.92	-				
		Max.	kW	3.47	6.40	7.51	11.18	-				
	4-Pipe	Min.	kW	-				0.82	1.18	1.76	2.83	
		Max.	kW	-				2.46	4.19	6.45	10.06	
Power input	Min.	W	2.2		3.4	4.2	2.2		3.24	4.2		
	Max.	W	57.4	82.7	101.4	147	57.4	82.7	101.4	147		
Dimensions	Unit	Height	mm	564								
		Width	mm	774	987	1,194	1,404	774	987	1,194	1,404	
		Depth	mm	226				251	226		251	
Weight	Unit	kg	20	25	31	41	21	26	33	44		
Heat exchanger	Water volume	l	0.7	1	1.4	2.1	0.7	1	1.4	2.1		
Additional heat exchanger	Water volume	l	-				0.2	0.3	0.4	0.6		
Water flow	Cooling	l/h	454	853	1,084	1,728	454	853	1,084	1,728		
	Heating	l/h	454	853	1,084	1,728	216	367	565	882		
Fan	Type		Centrifugal multi-blade, double suction									
	Quantity		1	2				1	2			
	Air flow rate	Max.	m ³ /h	560	900	1,200	1,660	560	900	1,200	1,660	
Min.		m ³ /h	70	95	130	200	70	95	130	200		
Sound power level	Max.	dB(A)	62	70	64	71	62	70	64	71		
Piping connections	Drain	OD	16									
Power supply	Phase/Frequency/Voltage	Hz/V	1~/50/230									
Current input	Max.	A	0.50	0.72	0.88	1.27	0.50	0.72	0.88	1.27		
	Min.	A	0.05		0.07	0.09	0.05		0.07	0.09		
Control systems	Wired remote control		FWEC3A / FWEC3A									

Floor standing unit

AC fan motor unit for vertical mounting

- › **Pre-assembled 3-way/4-port on/off valves** are available
- › **High efficiency** heat exchanger
- › Valve packages are **insulated**, no extra drain pan required
- › Valve packages contain balancing valves and sensor pocket
- › **Fast-on connections** for electrical options: no tools needed
- › **Washable air filter**, easily removable for maintenance
- › Electric heater: no relay up to 2kW capacity
- › Electric heater: equipped with two overheat cut-out thermostats



FWV-DAT/DAF				01	15	02	25	03	35	04	06	08	10	01	15	02	25	03	35	04	06	08	10												
				2-pipe										4-pipe																					
Cooling capacity	Total capacity	High	kW	1.54	1.74	1.96	2.42	2.93	3.51	4.33	4.77	6.71	8.02	1.46	1.69	1.79	2.38	2.87	3.46	4.26	4.67	6.64	7.88												
		Low	kW	1.04	1.26	1.36	1.60	1.76	1.98	2.51	3.17	3.97	4.11	0.99	1.24	1.26	1.58	1.73	1.96	2.48	3.11	3.93	4.07												
	Sensible capacity	High	kW	1.20	1.30	1.42	1.88	2.11	2.72	3.15	3.65	4.91	5.96	1.14	1.27	1.46	1.85	2.07	2.71	3.09	3.57	4.85	5.85												
		Low	kW	0.79	0.95	1.00	1.18	1.26	1.45	1.80	2.32	2.84	3.05	0.75	0.93	0.98	1.17	1.24	1.44	1.78	2.28	2.82	3.02												
Heating capacity	2-Pipe	High	kW	2.14	2.20	2.57	3.20	3.81	4.78	5.10	5.95	7.83	10.03																						
		Low	kW	1.43	1.71	1.79	2.07	2.28	2.81	2.98	3.96	4.77	5.24																						
	4-Pipe	High	kW											1.90	2.02	2.01	2.92	3.08	4.80	5.05	5.30	7.91	8.35												
		Low	kW											1.50	1.56	2.06	2.18	3.21	3.60	4.04	5.69	5.50													
Power input	High		W	37	53	57	56	98			182	244	37	53	57	56	98			182	244														
	Low		W	21	25	24	29		37	38	47	86	109	21	25	24	29		37	38	47	86	109												
Dimensions	Unit	Height	mm	564																															
		Width	mm	774				987				1,194				1,404				774				987				1,194				1,404			
		Depth	mm	226						226						251						226						251							
Weight	Unit		kg	19	20	25		30		31	41		20	21	26		32		33	44															
Heat exchanger	Water volume		l	0.5		0.7		1		1.4		2.1		0.5		0.7		1		1.4		2.1													
Additional heat exchanger	Water volume		l											0.2		0.3		0.4		0.6															
Water flow	Cooling		l/h	264	298	337	415	504	602	743	818	1,152	1,376	250	291	176	409	494	594	730	803	1,138	1,362												
	Heating		l/h	264	298	337	415	504	602	743	818	1,152	1,376	167	177	182	257	270	421	443	465	694	733												
Fan	Type			Centrifugal multi-blade, double suction																															
	Quantity			1				2				1				2																			
	Air flow rate	High	m ³ /h	319	344	442		640	706	785	1,011	1,393	307	330	327	432	431	628	690	763	998	1,362													
	Low	m ³ /h	178	211	241		320	361	470	570	642	174	205	238		316	356	460	565	636															
Sound power level	High		dB(A)	47	49	50	48		52	53	56	61	67	45	49	50	48	47	51	56	59	60	66												
Piping connections	Drain	OD	mm	16																															
Power supply	Phase/Frequency/Voltage		Hz/V	1~/50/230																															
Current input	High		A	0.17	0.24	0.26	0.25	0.44	0.43	0.82	1.10	0.17	0.24	0.26	0.25	0.44	0.43	0.82	1.10																
	Medium		A	0.13	0.16	0.21	0.20	0.29	0.31	0.57	0.76	0.13	0.16	0.21	0.20	0.29	0.31	0.57	0.76																
	Low		A	0.10	0.12	0.11	0.14	0.19	0.22	0.39	0.50	0.10	0.12	0.11	0.14	0.19	0.22	0.39	0.50																
Control systems	Wired remote control			FWEC1A / FWEC2A / FWEC3A / FWEC3A / FWEC3A / ECFWMB6																															

Flexi type unit with cabinet

BLDC fan motor unit for horizontal or vertical mounting.
Continuous air flow regulation and fan speed modulation

- › Up to 70% **energy savings** with brushless DC motor technology compared to traditional technology
- › **Instant adjustment** to temperature and relative humidity changes
- › **Low operating sound level**
- › Highly flexible solutions: multiple sizes, piping topologies and connection valves
- › Requires very **little installation space**



FWR-AT/AF				02	03	06	08	02	03	06	08
				2-pipe				4-pipe			
Cooling capacity	Total capacity	Min.	kW	0.61	0.88	1.19	1.79	0.60	0.88	1.19	1.79
		Max.	kW	2.64	4.96	6.32	10.08	2.64	4.96	6.32	10.08
	Sensible capacity	Min.	kW	0.41	0.58	0.79	1.20	0.40	0.58	0.79	1.20
		Max.	kW	1.95	3.60	4.80	7.43	1.95	3.60	4.80	7.43
Heating capacity	2-Pipe	Min.	kW	0.69	0.95	1.29	1.92	-			
		Max.	kW	3.47	6.40	7.51	11.18	-			
	4-Pipe	Min.	kW	-				0.82	1.18	1.76	2.83
		Max.	kW	-				2.46	4.19	6.45	10.06
Power input	Min.	W	2.2		3.4	4.2	2.2		3.24	4.2	
	Max.	W	57.4	82.7	101.4	147	57.4	82.7	101.4	147	
Dimensions	Unit	Height	mm	564							
		Width	mm	774	987	1,194	1,404	774	987	1,194	1,404
		Depth	mm	226				251			
Weight	Unit		kg	21	27	33	44	22	28	35	46
Heat exchanger	Water volume		l	0.7	1	1.4	2.1	0.7	1	1.4	2.1
Additional heat exchanger	Water volume		l	-				0.2	0.3	0.4	0.6
Water flow	Cooling		l/h	454	853	1,084	1,728	454	853	1,084	1,728
	Heating		l/h	454	853	1,084	1,728	216	367	565	882
Fan	Type			Centrifugal multi-blade, double suction							
	Quantity			1	2			1	2		
	Air flow rate	Max.	m ³ /h	560	900	1,200	1,660	560	900	1,200	1,660
Min.		m ³ /h	70	95	130	200	70	95	130	200	
Sound power level	Max.		dB(A)	62	70	64	71	62	70	64	71
Power supply	Phase/Frequency/Voltage		Hz/V	1~/50/230							
Current input	Max.		A	0.50	0.72	0.88	1.27	0.50	0.72	0.88	1.27
	Min.		A	0.05		0.07	0.09	0.05		0.07	0.09
Control systems	Wired remote control			FWEC3A / FWEC3A							

Flexi type unit with cabinet

AC fan motor unit for horizontal or vertical mounting

- › **Pre-assembled 3-way/4-port on/off valves** are available
- › **High efficiency** heat exchanger
- › Valve packages are **insulated**, no extra drain pan required
- › Valve packages contain balancing valves and sensor pocket
- › Fast-on connections for electrical options: no tools needed
- › **Washable air filter**, easily removable for maintenance
- › Electric heater: no relay up to 2kW capacity
- › Electric heater: equipped with two overheat cut-out thermostats



		FWL-DAT/DAF	01	15	02	25	03	35	04	06	08	10	01	15	02	25	03	35	04	06	08	10																					
			2-pipe										4-pipe																														
Cooling capacity	Total capacity	High	kW										kW																														
		Low	kW										kW																														
	Sensible capacity	High	kW										kW																														
		Low	kW										kW																														
Heating capacity	2-Pipe	High	kW										-																														
		Low	kW										-																														
	4-Pipe	High	kW										kW																														
		Low	kW										kW																														
Power input	High	W		53		57		56		98		182		244		37		53		57		56		98		182		244															
	Low	W		25		24		29		37		38		47		86		109		21		25		24		29		37		38		47		86		109							
Dimensions	Unit	Height	mm										564																														
		Width	774				987				1,194				1,404				774				987				1,194				1,404												
		Depth	226						251						226						251																						
Weight	Unit	kg		21		27		32		33		44		21		22		28		24		34		35		46																	
Heat exchanger	Water volume	l		0.5		0.7		1		1.4		2.1		0.5		0.7		1		1.4		2.1																					
Additional heat exchanger	Water volume	-										0.2				0.3				0.4				0.6																			
Water flow	Cooling	l/h		264		298		337		415		504		602		743		818		1,152		1,376		250		291		176		409		494		594		730		803		1,138		1,362	
	Heating	l/h		264		298		337		415		504		602		743		818		1,152		1,376		167		177		182		257		270		421		443		465		694		733	
Fan	Type	Centrifugal multi-blade, double suction																																									
	Quantity	1						2						1						2																							
	Air flow rate	High	m ³ /h		319		344		442		640		706		785		1,011		1,393		307		330		327		432		431		628		690		763		998		1,362				
Low	m ³ /h		178		211		241		320		361		470		570		642		174		205		238		316		356		460		565		636										
Sound power level	High	dBa		47		49		50		48		52		53		56		61		67		45		49		50		48		47		51		56		59		60		66			
Power supply	Phase/Frequency/Voltage	Hz/V		1~/50/230																																							
Current input	High	A		0.17		0.24		0.26		0.25		0.44		0.43		0.82		1.10		0.17		0.24		0.26		0.25		0.44		0.43		0.82		1.10									
	Medium	A		0.13		0.16		0.21		0.20		0.29		0.31		0.57		0.76		0.13		0.16		0.21		0.20		0.29		0.31		0.57		0.76									
	Low	A		0.10		0.12		0.11		0.14		0.19		0.22		0.39		0.50		0.10		0.12		0.11		0.14		0.19		0.22		0.39		0.50									
Control systems	Wired remote control	FWEC1A / FWEC2A / FWEC3A / FWEC3A / FWEC3A / ECFWMB6																																									

Flexi type unit without cabinet

BLDC fan motor unit for horizontal or vertical concealed mounting. Continuous air flow regulation and fan speed modulation

- › **Blends unobtrusively** with any interior décor: only the suction and discharge grilles are visible
- › Up to 70% **energy savings** with brushless DC motor technology compared to traditional technology
- › **Instant adjustment** to temperature and relative humidity changes
- › **Low operating sound level**
- › Highly flexible solutions: multiple sizes, piping topologies and connection valves



FWS-AT/AF				02	03	06	08	02	03	06	08	
				2-pipe				4-pipe				
Cooling capacity	Total capacity	Min.	kW	0.61	0.88	1.19	1.79	0.60	0.88	1.19	1.79	
		Max.	kW	2.64	4.96	6.32	10.08	2.64	4.96	6.32	10.08	
	Sensible capacity	Min.	kW	0.41	0.58	0.79	1.20	0.40	0.58	0.79	1.20	
Heating capacity	2-Pipe	Min.	kW	0.69	0.95	1.29	1.92	-				
		Max.	kW	3.47	6.40	7.51	11.18	-				
	4-Pipe	Min.	kW	-				0.82	1.18	1.76	2.83	
		Max.	kW	-				2.46	4.19	6.45	10.06	
Power input	Min.	W	2.2		3.4	4.2	2.2		3.24	4.2		
	Max.	W	57.4	82.7	101.4	147	57.4	82.7	101.4	147		
Dimensions	Unit	Height	mm	535								
		Width	mm	584	794	1,004	1,214	584	794	1,004	1,214	
		Depth	mm	224				249				
Weight	Unit	kg	15	19	23	32	16	20	25	34		
Heat exchanger	Water volume	l	0.7	1	1.4	2.1	0.7	1	1.4	2.1		
Additional heat exchanger	Water volume	l	-				0.2	0.3	0.4	0.6		
Water flow	Cooling	l/h	454	853	1,084	1,728	454	853	1,084	1,728		
	Heating	l/h	454	853	1,084	1,728	216	367	565	882		
Fan	Type		Centrifugal multi-blade, double suction									
	Quantity		1	2				1	2			
	Air flow rate	Max.	m ³ /h	560	900	1,200	1,660	560	900	1,200	1,660	
Min.		m ³ /h	70	95	130	200	70	95	130	200		
Sound power level	Max.	dB(A)	62	70	64	71	62	70	64	71		
Piping connections	Drain	OD	17									
Power supply	Phase/Frequency/Voltage	Hz/V	1~/50/230									
Current input	Max.	A	0.50	0.72	0.88	1.27	0.50	0.72	0.88	1.27		
	Min.	A	0.05		0.07	0.09	0.05		0.07	0.09		
Control systems	Wired remote control		FWEC3A / FWEC3A									

Flexi type unit without cabinet

AC fan motor unit for horizontal or vertical concealed mounting

- › **Pre-assembled 3-way/4-port on/off valves** are available
- › **High efficiency** heat exchanger
- › Valve packages are **insulated**, no extra drain pan required
- › Valve packages contain balancing valves and sensor pocket
- › Fast-on connections for electrical options: no tools needed
- › **Washable air filter**, easily removable for maintenance
- › Electric heater: no relay up to 2kW capacity
- › Electric heater: equipped with two overheat cut-out thermostats



FWM-DAT/DAF				01	15	02	25	03	35	04	06	08	10	01	15	02	25	03	35	04	06	08	10												
				2-pipe										4-pipe																					
Cooling capacity	Total capacity	High	kW	1.54	1.74	1.96	2.42	2.93	3.51	4.33	4.77	6.71	8.02	1.46	1.69	1.79	2.38	2.87	3.46	4.26	4.67	6.64	7.88												
		Low	kW	1.04	1.26	1.36	1.60	1.76	1.98	2.51	3.17	3.97	4.11	0.99	1.24	1.26	1.58	1.73	1.96	2.48	3.11	3.93	4.07												
	Sensible capacity	High	kW	1.20	1.30	1.42	1.88	2.11	2.72	3.15	3.65	4.91	5.96	1.14	1.27	1.46	1.85	2.07	2.71	3.09	3.57	4.85	5.85												
		Low	kW	0.79	0.95	1.00	1.18	1.26	1.45	1.80	2.32	2.84	3.05	0.75	0.93	0.98	1.17	1.24	1.44	1.78	2.28	2.82	3.02												
Heating capacity	2-Pipe	High	kW	2.14	2.20	2.57	3.20	3.81	4.78	5.10	5.95	7.83	10.03																						
		Low	kW	1.43	1.71	1.79	2.07	2.28	2.81	2.98	3.96	4.77	5.24																						
	4-Pipe	High	kW											1.90	2.02	2.01	2.92	3.08	4.80	5.05	5.30	7.91	8.35												
		Low	kW											1.50	1.56	2.06	2.18	3.21	3.60	4.04	5.69	5.50													
Power input	High	W	37	53	57	56	98			182	244	37	53	57	56	98			182	244															
	Low	W	21	25	24	29		37	38	47	86	109	21	25	24	29		37	38	47	86	109													
Dimensions	Unit	Height	mm	535																															
		Width	mm	584				794				1,004				1,214				584				794				1,004				1,214			
		Depth	mm	224						249						224						249													
Weight	Unit	kg	14	15	19			23			32			15	16	20			25			34													
Heat exchanger	Water volume	l	0.5		0.7		1		1.4		2.1		0.5		0.7		1		1.4		2.1														
Additional heat exchanger	Water volume	l											0.2		0.3		0.4		0.6																
Water flow	Cooling	l/h	264	298	337	415	504	602	743	818	1,152	1,376	250	291	176	409	494	594	730	803	1,138	1,362													
	Heating	l/h	264	298	337	415	504	602	743	818	1,152	1,376	167	177	182	257	270	421	443	465	694	733													
Fan	Type	Centrifugal multi-blade, double suction																																	
	Quantity	1										2																							
	Air flow rate	High	m³/h	319	344	442		640	706	785	1,011	1,393	307	330	327	432	431	628	690	763	998	1,362													
	Low	m³/h	178	211	241		320	361	470	570	642	174	205	238		316	356	460	565	636															
Sound power level	High	dBA	47	49	50	48		52	53	56	61	67	45	49	50	48	47	51	56	59	60	66													
Piping connections	Drain	OD	17																																
Power supply	Phase/Frequency/Voltage	Hz/V	1~/50/230																																
Current input	High	A	0.17	0.24	0.26	0.25	0.44	0.43	0.82	1.10	0.17	0.24	0.26	0.25	0.44	0.43	0.82	1.10																	
	Medium	A	0.13	0.16	0.21	0.20	0.29	0.31	0.57	0.76	0.13	0.16	0.21	0.20	0.29	0.31	0.57	0.76																	
	Low	A	0.10	0.12	0.11	0.14	0.19	0.22	0.39	0.50	0.10	0.12	0.11	0.14	0.19	0.22	0.39	0.50																	
Control systems	Wired remote control	FWEC1A / FWEC2A / FWEC3A / FWECSA																																	

Wall mounted unit

AC fan motor unit for wall mounting

- › High **aesthetic cabinet design**
- › **Optimum air distribution**
- › Easy to install
- › 3-speed fan motor
- › **Low operating sound level** thanks to tangential fan
- › Insulated with self-extinguishing class 1 heat insulation
- › Removable washable air filter (self-extinguishing class 1)



FWT-CT				02	03	04	05	06
				2-pipe				
Cooling capacity	Total capacity	High	kW	2.43	2.70	3.31	4.54	5.28
		Low	kW	2.11	2.23	2.78	3.81	4.40
	Sensible capacity	High	kW	1.85	2.02	2.64	3.43	4.10
		Low	kW	1.49	1.61	2.05	2.81	3.28
Heating capacity	2-Pipe	High	kW	3.22	3.52	4.40	6.01	7.33
		Low	kW	2.49	2.70	3.37	4.84	5.86
Power input	High		W	31	32	42	53	72
	Low		W	25	29	33	42	60
Dimensions	Unit	Height	mm	288			310	
		Width	mm	800			1,065	
		Depth	mm	206			224	
Weight	Unit		kg	9			14	
	Operation weight		kg	9.5	9.6		15	
Heat exchanger	Water volume		l	0.52	0.58		0.95	
Water flow	Cooling		l/h	420	460	570	780	910
	Heating		l/h	420	460	570	780	910
Fan	Type			Cross flow fan				
	Quantity			1				
	Air flow rate	High	m ³ /h	442	476	629	866	1,053
Low		m ³ /h	340	374	442	663	782	
Sound power level	High		dBA	45	48	55		59
Sound pressure level	High		dBA	34	35	42		46
Piping connections	Drain	OD	mm	19				
Water connections	Std. heat exchanger		inch	1/2				
Power supply	Phase/Frequency/Voltage		Hz/V	/-/-				
Current input	High		A	0.19	0.20	0.21	0.29	0.34
	Medium		A	0.18	0.20		0.26	0.32
	Low		A	0.17	0.19		0.25	0.31
Control systems	Infrared remote control			WRC-HPC				
	Wired remote control			MERCA / SRC-HPA				

Low ESP ducted unit

AC fan motor unit for horizontal concealed mounting

- › **Easy installation and maintenance**
- › **4-speed fan motor**
- › High power air flow
- › Wired electronic controllers range
- › Available static pressure up to 50Pa
- › Wide operating range
- › Standard left and right side water connection
- › **Extended drain pan** as standard
- › **Factory mounted valve** (both left and right side)
- › Nylon filter G2 class
- › Polyethylene insulation



FWE-CT/CF				02	03	04	06	07	08	10	02	03	04	06	07	08	10	
				2-pipe							4-pipe							
Cooling capacity	Total capacity	Super high	kW	2.17	3.22	4.34	6.06	6.83	7.84	9.96	2.10	3.16	3.98	6.05	6.78	7.79	9.91	
		High	kW	1.81	2.78	3.49	5.32	5.68	6.92	8.64	1.76	2.69	3.22	5.20	5.61	6.79	8.61	
		Low	kW	0.90	1.40	1.80	2.80	3.10	3.90	4.90	0.85	1.40	1.63	2.72	3.10	3.88	4.88	
	Sensible capacity	Super high	kW	1.61	2.44	3.27	4.55	4.83	6.02	7.58	1.55	2.37	3.19	4.49	5.16	5.91	7.45	
		High	kW	1.33	2.08	2.58	3.94	4.30	5.25	6.48	1.28	1.99	2.53	3.81	4.20	5.09	6.39	
		Low	kW	0.70	1.20	1.40	2.10	2.50	3.10	3.70	0.66	1.18	1.35	2.02	2.47	3.05	3.65	
Heating capacity	2-Pipe	Super high	kW	2.79	4.28	5.61	7.66	9.26	10.50	13.00								
		High	kW	2.31	3.67	4.44	6.65	7.62	9.18	11.10								
		Low	kW	1.20	2.00	2.30	3.40	4.40	5.30	6.30								
	4-Pipe	Super high	kW															
		High	kW															
		Low	kW															
Power input	Super high	W	46	69	83	119	163	181	230	46	69	83	119	163	181	230		
	High	W	39	54	59	93	128	145	180	39	54	59	93	128	145	180		
	Low	W	29	40	42	60	89	102	121	29	40	42	60	89	102	121		
Dimensions	Unit	Height	mm	253														
		Width	mm	590														
		Depth	mm	705	875	1,005	1,205	1,455	1,555	1,815	705	875	1,005	1,205	1,455	1,555	1,815	
Weight	Unit	kg	17	20	24	28	37	39	46	18	22	25	30	40	41	49		
	Operation weight	kg	17	20	24	28	37	39	46	18	22	25	30	40	41	49		
Heat exchanger	Water volume	l	0.74	1.02	1.24	1.56	1.97	2.14	2.56	0.74	1.02	1.24	1.56	1.97	2.14	2.56		
Additional heat exchanger	Water volume	l								0.25	0.34	0.41	0.52	0.66	0.71	0.85		
	Cooling	l/h	360	540	756	1,044	1,188	1,368	1,728	360	540	720	1,044	1,188	1,332	1,728		
	Heating	l/h	252	360	504	684	828	936	1,188									
	Additional heat exchanger	l/h								108	180	216	324	432	468	576		
Water pressure drop	Additional heat exchanger	kPa								3.6	8.8	15.6	31.8	58.6	74.6	123		
Fan	Type	Centrifugal (Blade: Forward - curve)																
	Quantity																	
	Air flow rate	Super high	m ³ /h	430	638	910	1,195	1,559	1,753	2,177	416.13	626.11	834.52	1,193.03	1,547.59	1,741.82	2,166.07	
		High	m ³ /h	311	518	619	926	1,188	1,413	1,735	302.41	501.23	571.11	905.11	1,173.36	1,386.46	1,728.98	
		Low	m ³ /h	150	256	284	426	569	688	808	142	256	257.48	414.34	569	684.16	804.37	
Sound power level	Super high	dB(A)	51	61	58	62		64	65	51	61	58	62		64	65		
	High	dB(A)	49	56	48	55	57	58	60	49	56	48	55	57	58	60		
Sound pressure level	Super high	dB(A)	41	51	48	52		54	55	41	51	48	52		54	55		
	High	dB(A)	39	46	38	45	47	48	49	39	46	38	45	47	48	49		
Piping connections	Drain	OD	19.05															
Water connections	Std. heat exchanger	inch	3/4															
	Add. heat exchanger	inch									3/4							
Power supply	Phase/Frequency/Voltage	Hz/V	1~/50/220-240															
Current input	Super high	A	0.206	0.309	0.372	0.533	0.731	0.811	1.031	0.206	0.309	0.372	0.533	0.731	0.811	1.031		
	High	A	0.174	0.243	0.265	0.430	0.575	0.648	0.780	0.174	0.243	0.265	0.430	0.575	0.648	0.780		
	Medium	A	0.150	0.208	0.217	0.325	0.472	0.523	0.648	0.150	0.208	0.217	0.325	0.472	0.523	0.648		
	Low	A	0.128	0.177	0.188	0.271	0.400	0.456	0.540	0.128	0.177	0.188	0.271	0.400	0.456	0.540		
Control systems	Wired remote control	FWEC1A / FWEC2A / FWEC3A / FWEC3A																

Medium ESP ducted unit

AC fan motor unit for horizontal concealed mounting

- › **Compact dimensions**, can easily be mounted in a narrow ceiling void
- › 3, 4 or 6 stage row cooling coil
- › Drain pan to collect the condensate from: heat exchanger and regulating valves
- › **7-speed electrical motors** (with thermal protection on windings)
- › All 7 speeds **pre-wired in the factory** in the terminal block of the switch box
- › **Washable air filter**, easily removable for maintenance

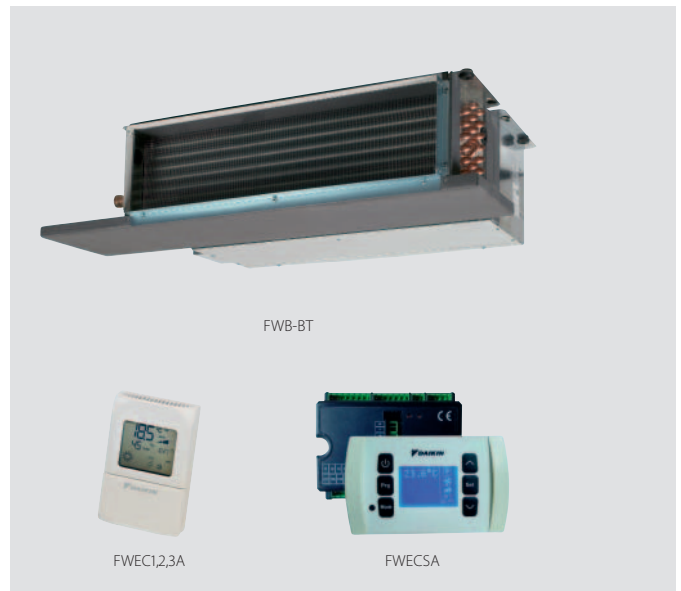

			FWB-BT	02	03	04	05	06	07	08	09	10
				2-pipe								
Cooling capacity	Total capacity	High	kW	2.61	3.14	3.49	5.08	5.45	6.47	7.57	8.67	10.34
		Low	kW	1.34	1.50	1.67	2.12	2.43	2.67	4.18	4.64	5.35
	Sensible capacity	High	kW	1.88	2.16	2.34	3.6	3.87	4.4	5.23	5.96	6.9
		Low	kW	0.95	1.02	1.1	1.52	1.67	1.78	2.95	3.21	3.57
Heating capacity	2-Pipe	High	kW	5.47	6.01	6.47	10.31	11.39	12.28	15.05	16.85	18.78
		Low	kW	2.77	2.91	3.00	4.56	4.77	4.94	8.63	9.29	9.85
	4-Pipe	High	kW		3.14			5.99				12.8
		Low	kW		1.95			3.38				7.67
Power input	High		W		79			154			294	
	Low		W		28			64			155	
Dimensions	Unit	Height	mm	239								
		Width	mm	1,039			1,389			1,739		
		Depth	mm	609								
Weight	Unit		kg	23	24	26	31	33	35	43	45	48
	Operation weight		kg	24	26	28	33	35	38	45	48	52
Heat exchanger	Water volume		l	1.1	1.5	2.2	1.6	2.1	3.2	2.1	2.8	4.2
Additional heat exchanger	Water volume		l	0.4			0.6			1.7		
Water flow	Cooling		l/h	448	539	598	873	936	1,111	1,299	1,488	1,774
	Heating		l/h	480	527	567	904	999	1,077	1,319	1,479	1,647
	Additional heat exchanger		l/h	275			526			1,123		
Water pressure drop	Additional heat exchanger		kPa	3			5			8		
Fan	Type			Centrifugal - forward blades - directly coupled on fan motor								
	Quantity			1			2			3		
	Air flow rate	High	m ³ /h	400			800			1,200		
		Low	m ³ /h	180			300			600		
	Available pressure	High	Pa	71			65			59		
Sound power level	High		dBA	56			59			69		
Sound pressure level	High		dBA	44.5			47.5			57.5		
Electric heater	Power input		kW	2			2.5			3		
Piping connections	Drain	OD	mm	16								
Water connections	Std. heat exchanger		inch	3/4								
	Add. heat exchanger		inch	3/4						1		
Power supply	Phase/Frequency/Voltage		Hz/V					1~/50/230				
Current input	High		A	0.36			0.73			1.28		
	Medium		A	0.21			0.60			0.90		
	Low		A	0.14			0.33			0.70		
Control systems	Wired remote control			FWEC1A / FWEC2A / FWEC3A / FWEC3A								

Medium ESP ducted unit

BLDC fan motor unit for horizontal concealed mounting.
Continuous air flow regulation and fan speed modulation

- › **Blends unobtrusively** with any interior décor: only the suction and discharge grills are visible
- › Up to 50% **energy savings** with brushless DC motor technology compared to traditional technology
- › **Instant adjustment** to temperature and relative humidity changes
- › **Low operating sound level**
- › Highly flexible solutions: multiple sizes, piping topologies and connection valves



FWP-AT				02	03	04	05	06	07
				2-pipe					
Cooling capacity	Total capacity	High	kW	2.61	3.14	3.49	5.08	5.45	6.47
		Low	kW	1.34	1.5	1.67	2.12	2.43	2.67
	Sensible capacity	High	kW	1.88	2.16	2.34	3.6	3.87	4.4
		Low	kW	0.95	1.02	1.1	1.52	1.67	1.78
Heating capacity	2-Pipe	High	kW	5.47	6.01	6.47	10.31	11.39	12.28
		Low	kW	2.77	2.91	3.00	4.56	4.77	4.94
	4-Pipe	High	kW		3.14			5.99	
		Low	kW		1.95			3.38	
Power input	High		W		46.4			80	
	Low		W		12.2			17.5	
Dimensions	Unit	Height	mm	239					
		Width	mm	1,039			1,389		
		Depth	mm	609					
Weight	Unit		kg	23	24	26	31	33	35
	Operation weight		kg	24	26	28	33	35	38
Heat exchanger	Water volume		l	1.1	1.5	2.2	1.6	2.1	3.2
Additional heat exchanger	Water volume		l	0.4			0.6		
Water flow	Cooling		l/h	448	539	598	873	936	1,111
	Heating		l/h	480	527	567	904	999	1,077
	Additional heat exchanger		l/h	275			526		
Water pressure drop	Additional heat exchanger		kPa	3			5		
Fan	Type	Centrifugal - forward blades - directly coupled on fan motor							
	Quantity	1							
	Air flow rate	High	m ³ /h	400			800		
		Low	m ³ /h	180			300		
Available pressure	High	Pa	71			65			
Sound power level	High		dBA	55.6			60.6		
Sound pressure level	High		dBA	44.1			49.1		
Electric heater	Power input		kW	2			2.5		
Piping connections	Drain	OD	mm	16					
	Water connections	Std. heat exchanger	inch	3/4					
Add. heat exchanger		inch	3/4						
Power supply	Phase/Frequency/Voltage		Hz/V	1~/50/230					
Control systems	Wired remote control			FWEC3A / FWEC3A					

High ESP ducted unit

AC fan motor unit for horizontal or vertical concealed mounting

- › Straight duct connector mounted to discharge side
- › **Washable air filter**, easily removable for maintenance



FWD-AT/AF				04	06	08	10	12	16	18	04	06	08	10	12	16	18
				2-pipe						4-pipe							
Cooling capacity	Total capacity	High	kW	3.90	6.20	7.80	8.82	11.90	16.40	18.30	3.90	6.20	7.80	8.82	11.90	16.40	18.30
	Sensible capacity	High	kW	3.08	4.65	6.52	7.16	9.36	12.80	14.10	3.08	4.65	6.52	7.16	9.36	12.80	14.10
Heating capacity	2-Pipe	High	kW	4.05	7.71	9.43	10.79	14.45	19.81	21.92	-						
	4-Pipe	High	kW	-						4.49	6.62	9.21	15.86	21.15			
Power input	High		W	234	349	443	714	1,197			234	349	443	714	1,197		
	Low		W	130	247	261	328	704			130	247	261	328	704		
Dimensions	Unit	Height	mm	280						352							
		Width	mm	754	964	1,174		1,384		754	964	1,174		1,384			
		Depth	mm	559						718							
Weight	Unit		kg	33	41	47	49	65	77	80	35	43	50	52	71	83	86
Heat exchanger	Water volume		l	1.06	1.42	1.79	2.38	2.5	4.02	5.03	1.06	1.42	1.79	2.38	2.50	4.02	5.03
Additional heat exchanger	Water volume		l	-						0.35	0.47	0.59	1.42	1.72			
Water flow	Cooling		l/h	674	1,064	1,339	1,514	2,056	2,833	3,140	674	1,064	1,339	1,514	2,056	2,833	3,140
	Heating		l/h	674	1,064	1,339	1,514	2,056	2,833	3,140	349	581	808	1,392	1,856		
Fan	Type			Centrifugal multi-blade, double suction													
	Quantity			1	2						1	2					
	Air flow rate	High	m ³ /h	800	1,250	1,600	2,200	3,000	800	1,250	1,600	2,200	3,000				
	Available pressure	High	Pa	66	58	68	64	97	145	134	63	53	63	59	92	138	128
Sound power level	High		dB(A)	66	69	72	74	78	66	69	72	74	78				
Piping connections	Drain	OD	mm	16													
Water connections	Std. heat exchanger		inch	3/4						1	3/4						1
Power supply	Phase/Frequency/Voltage		Hz/V	1~/50/230													
Current input	High		A	0.95	1.58	1.97	3.21	5.37	0.95	1.58	1.97	3.21	5.37				
	Medium		A	0.74	1.39	1.52	2.08	4.38	0.74	1.39	1.52	2.08	4.38				
	Low		A	0.57	1.18	1.20	1.50	3.26	0.57	1.18	1.20	1.50	3.26				
Control systems	Wired remote control			FWEC1A / FWEC2A / FWEC3A / FWECSA													

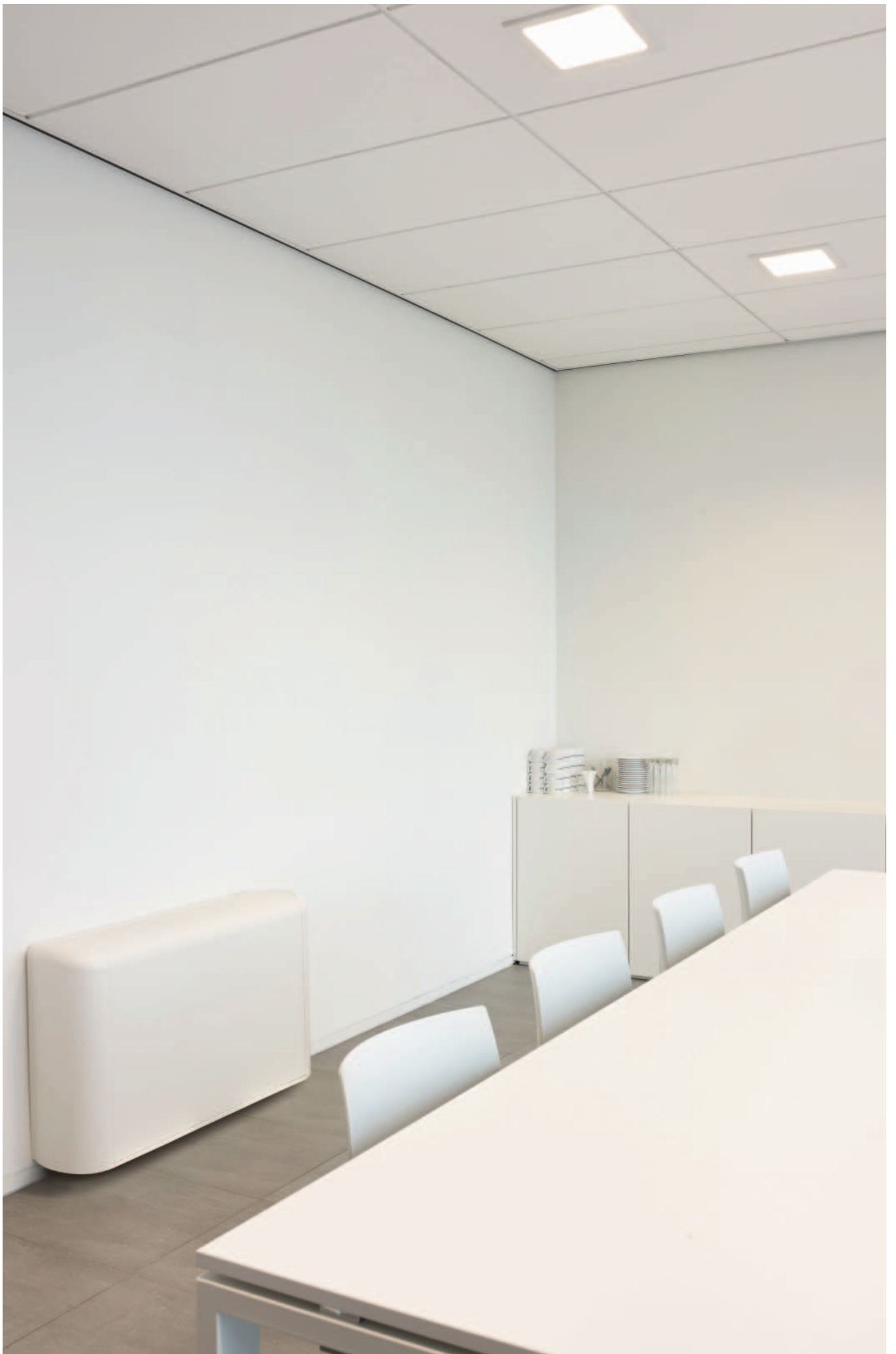

Accessories - Fan coil units

Network & control systems	FWM~D / FWL~D / FWV~D										FWS~A / FWR~A / FWZ~A			
	1	15	2	25	3	35	4	6	8	10	2	3	6	8
Wired remote controller (Standard)	FWEC1A										-			
Wired remote controller (Advanced)	FWEC2A										-			
Wired remote controller (Advanced Plus)	FWEC3A										FWEC3A			
Split controller - power control board	FWECSAP										FWECSAP			
Split controller - control panel	FWECSAC										FWECSAC			
Controller electromechanical	ECFWMB6										-			
On board mounting kit	FWECKA										FWECKA			
Wall mounting kit	FWFCKA										FWFCKA			
Wired remote controller (Cooling only)	-										-			
Wired remote controller (Heat pump)	-										-			
Wireless controller (Cooling only)	-										-			
Wireless controller (Heat pump)	-										-			
Temperature sensor kit	FWTSKA										FWTSKA			
Relative humidity sensor kit	FWHSKA										FWHSKA			
Fan stop thermostat	YFSTA6										-			
Master slave interface	EPIMSA6										-			
Power interface	-										-			
Optional PCB for MOD-bus connection	-										-			

Valves	FWM~D / FWL~D / FWV~D										FWS~A / FWR~A / FWZ~A				
	1	15	2	25	3	35	4	6	8	10	2	3	6	8	
3-ways 230V on/off valve kit (2-pipe)	E2MV03A6			E2MV06A6			E2MV10A6			E2MV03A6			E2MV10A6		
3-ways 230V on/off valve kit (4-pipe)	E4MV03A6			E4MV06A6			E4MV10A6			E4MV03A6			E4MV10A6		
2-ways 230V on/off valve kit (cooling heat exchanger)	E2MV2B07A6					E2MV2B10A6					E2MV2B07A6		E2MV2B10A6		
2-ways 230V on/off valve kit (additional heat exchanger)	E2MV2B07A6										E2MV2B07A6				
Simplified 3-ways 230V on/off valve kit (2-pipe)	E2MVD03A6			E2MVD06A6			E2MVD10A6			E2MVD03A6		E2MVD06A6		E2MVD10A6	
Simplified 3-ways 230V on/off valve kit (4-pipe)	E4MVD03A6			E4MVD06A6			E4MVD10A6			E4MVD03A6		E4MVD06A6		E4MVD10A6	
3-ways 24V on/off valve kit (2-pipe)	E2M2V03A6			E2M2V06A6			E2M2V10A6			E2M2V03A6		E2M2V06A6		E2M2V10A6	
3-ways 24V on/off valve kit (4-pipe)	E4M2V03A6			E4M2V06A6			E4M2V10A6			E4M2V03A6		E4M2V06A6		E4M2V10A6	
3-ways proportional valve kit (2-pipe)	E2MPV03A6			E2MPV06A6			E2MPV10A6			-					
3-ways proportional valve kit (4-pipe)	E4MPV03A6			E4MPV06A6			E4MPV10A6			-					
2-ways 24V on/off valve kit (cooling heat exchanger)	E2M2V207A6					E2M2V210A6					E2M2V207A6		E2M2V210A6		
2-ways 24V on/off valve kit (additional heat exchanger)	E2M2V207A6										E2M2V207A6				
2-ways proportional valve kit (cooling heat exchanger)	E2MPV207A6					E2MPV210A6					-				
2-ways proportional valve kit (additional heat exchanger)	E2MPV207A6										-				
3-ways 230V on/off valve kit (additional heat exchanger)	-										-				
2-ways 230V on/off valve kit (2-pipe)	-										-				
2-ways 230V on/off valve kit (4-pipe)	-										-				

Panels	FWM~D / FWL~D / FWV~D										FWS~A / FWR~A / FWZ~A			
	1	15	2	25	3	35	4	6	8	10	2	3	6	8
Decoration panel 600x600 (2-pipe)	-										-			
Decoration panel 900x900 (2-pipe)	-										-			
Decoration panel 900x900 (4-pipe)	-										-			

In case of FWF-C and FWG-A ranges, decoration panel code includes also wireless controller

FWD~A							FWB~B			FWP~A		FWE~C	FWT~C	FWC~B	FWF~B	FWF~C	FWG-A			
4	6	8	10	12	16	18	2-4	5-7	8-10	2-4	5-7	All sizes	All sizes	All sizes	All sizes	All sizes	5-8	11		
FWEC1A							FWEC1A			-		FWEC1A	MERCA	BRC315D	BRC315D	MERCA	BRC51A61			
FWEC2A							FWEC2A			-		FWEC2A	-	-	-	-	-			
FWEC3A							FWEC3A			FWEC3A		FWEC3A	-	-	-	-	-			
FWEC3AP							FWEC3AP			FWEC3AP		FWEC3AP	-	-	-	-	-			
FWEC3AC							FWEC3AC			FWEC3AC		FWEC3AC	-	-	-	-	-			
-							-			-		-	-	-	-	-	-			
-							-			-		-	-	-	-	-	-			
FWFCKA							FWFCKA			FWFCKA		FWFCKA	-	-	-	-	-	-		
-							-			-		-	-	-	-	-	-			
-							-			-		-	SRC-HPA	-	-	SRC-HPA	-			
-							-			-		-	-	-	-	-	-	-		
-							-			-		-	WRC-HPC	BRC7F532F	BRC7F530	-	-	-		
FWTSKA							FWTSKA			FWTSKA		FWTSKA	-	-	-	-	-	-		
FWHska							FWHska			FWHska		FWHska	-	-	-	-	-	-		
YFSTA6							YFSTA6			-		-	-	-	-	-	-			
EPIMSA6							EPIMSA6			-		EPIMSA6	-	-	-	-	-	-		
-				EPIB6			-			-		-	-	-	-	-	-			
-							-			-		-	-	EKFCMBCB	EKFCMBCB	-	-	-		

FWD~A							FWB~B			FWP~A		FWE~C	FWT~C	FWC~B	FWF~B	FWF~C	FWG-A				
4	6	8	10	12	16	18	2-4	5-7	8-10	2-4	5-7	All sizes	All sizes	All sizes	All sizes	All sizes	5-8	11			
ED2MV04A6	ED2MV10A6	ED2MV12A6	ED2MV18A6	-			-			-		EK2MV3B10C5	-	EKMV3C09B	EKMV3C09B	MCKCW2T3VN	VKFWGA012T3V	VKFWGA022T3V			
ED4MV04A6	ED4MV10A6	2 x ED2MV12A6	2 x ED2MV18A6	-			-			-		EK4MV3B10C5	-	2 x EKMV3C09B	2 x EKMV3C09B	-	VKFWGA014T3V	VKFWGA024T3V			
-							E2MV207A6	E2MV210A6	-			-	-	-	-	-	-	-	-		
-							E2MV207A6	E2MV210A6	E2MV207A6	-			-	-	-	-	-	-	-		
-							-			-		-	-	-	-	-	-	-			
-							-			-		-	-	-	-	-	-	-			
-							-			-		-	-	-	-	-	-	-			
-							-			-		-	-	-	-	-	-	-			
-							-			-		-	-	-	-	-	-	-			
-							-			-		-	-	-	-	-	-	-			
-							-			-		-	-	-	-	-	-	-			
-							-			-		-	-	-	-	-	-	-			
-							E2MV307A6	E2MV310A6	E2MV307A6	-			-	-	-	-	-	-	-		
-							-			-		EK2MV2B10C5	-	EKMV2C09B	EKMV2C09B	-	-	-			
-							-			-		EK4MV2B10C5	-	2 x EKMV2C09B	2 x EKMV2C09B	-	-	-			

FWD~A							FWB~B			FWP~A		FWE~C	FWT~C	FWC~B	FWF~B	FWF~C	FWG-A	
4	6	8	10	12	16	18	2-4	5-7	8-10	2-4	5-7	All sizes	All sizes	All sizes	All sizes	All sizes	5-8	11
-							-			-		-	-	-	BYFQ60B	DCP600TC	-	-
-							-			-		-	-	BYCQ140C	-	-	-	DCP900BTA
-							-			-		-	-	BYCQ140C	-	-	-	DCP900BFA

Accessories - Fan coil units and air handling units

Other accessories	FWM~D / FWL~D / FWV~D										FWS~A / FWR~A / FWZ~A			
	1	15	2	25	3	35	4	6	8	10	2	3	6	8
Electric heater (Standard)	EEH01A6	EEH02A6		EEH03A6		EEH06A6			EEH10A6		EEH02A6	EEH03A6	EEH06A6	EEH10A6
Electric heater (Big)	-										-			
Fresh air intake	EFA02A6		EFA03A6		EFA06A6		EFA10A6			EFA02A6	EFA03A6	EFA06A6	EFA10A6	
Additional heat exchanger	ESRH02A6		ESRH03A6		ESRH06A6		ESRH10A6			ESRH02A6	ESRH03A6	ESRH06A6	ESRH10A6	
Air intake & discharge grille	EAIDF02A6		EAIDF03A6		EAIDF06A6		EAIDF10A6			EAIDF02A6	EAIDF03A6	EAIDF06A6	EAIDF10A6	
Rear panel	ERPVO2A6		ERPVO3A6		ERPVO6A6		ERPVO10A6			ERPVO2A6	ERPVO3A6	ERPVO6A6	ERPVO10A6	
Supporting feet	ESFV06A6						ESFV10A6			ESFV06A6			ESFV10A6	
Supporting feet & grille	ESFVG02A6		ESFVG03A6		ESFVG06A6		ESFVG10A6			ESFVG02A6	ESFVG03A6	ESFVG06A6	ESFVG10A6	
Plenum box with circular connections	EPCC02A6 (only for FWM-D)		EPCC03A6 (only for FWM-D)		EPCC06A6 (only for FWM-D)		EPCC10A6 (only for FWM-D)			EPCC02A6 (only for FWS-A)	EPCC03A6 (only for FWS-A)	EPCC06A6 (only for FWS-A)	EPCC10A6 (only for FWS-A)	
Vertical auxiliary drainpan	EDPVB6						EDPVB6							
Horizontal auxiliary drainpan	EDPHB6						EDPHB6							

Mechanical options	FWC~BT/BF	FWF~BT/BF
Sealing member of air discharge outlet	KDBHQ55C140	KDBH44BA60
Long-life filter	KAFP551K160	KAFQ441BA60
Fresh air intake kit (20% fresh air) (Direct installation)	KDDQ55C140	-
Fresh air intake kit (Direct installation)	-	KDDQ44XA60
Panel spacer	KDBQ44B60	-

Control options	FWF~BT/BF	FWC~BT/BF
Remote sensor	KRCS01-1	KRCS01-4
Remote ON / OFF	EKROROA	-
Installation box for adaptor PCB	KRP1BA101	KRP1H98

Wiring adapter for electrical appendices KRP1BA101 KRP1H98

Control options	FWF~BT/BF - FWC~BT/BF
Central remote control	DCS302CA51
Intelligent touch controller	DCS601C51C
Unified ON/OFF controller	DCS301BA51
Electrical installation box with earth terminal (2 blocks)	KJB212A
Electrical installation box with earth terminal (3 blocks)	KJB311A
Electrical installation box	KJB411A
Schedule timer	DST301BA51
Wiring adapter for electrical appendices	KRP1BA101
Wiring adapter for electrical appendices	KRP1H98

FWD~A						FWB~B			FWP~A		FWE~C	FWT~C	FWC~B	FWF~B	FWF~C	FWG~A		
4	6	8	10	12	16	18	2-4	5-7	8-10	2-4	5-7	All sizes	All sizes	All sizes	All sizes	All sizes	5-8	11
EDEH04A6	EDEHS06A6	EDEHS10A6	EDEHS12A6	EDEHS18A6	Factory mounted			Factory mounted		-	-	-	-	-	-	-	-	-
EDEH04A6	EDEHB06A6	EDEHB10A6	EDEHB12A6	EDEHB18A6	-			-		-	-	-	-	-	-	-	-	-
EDMFA04A6	EDMFA06A6	EDMFA10A6	EDMFA12A6	EDMFA18A6	-			-		-	-	-	-	-	-	-	-	-
-							EAH04A6	EAH07A6	EAH10A6	EAH04A6	EAH07A6	-	-	-	-	-	-	-
-							-			-		-	-	-	-	-	-	-
-							-			-		-	-	-	-	-	-	-
-							-			-		-	-	-	-	-	-	-
-							-			-		-	-	-	-	-	-	-
EDDPV10A6				EDDPV18A6			-			-		-	-	-	-	-	-	-
EDDPH10A6				EDDPH18A6			-			-		-	-	-	-	-	-	-

D-AHU Professional

Construction type		SP 65	SP 45	FP 50	FP 25
Profile	Aluminium	standard	standard	standard	standard
	Anodized aluminium	option	option	option	option
	Aluminium with thermal break	option	option	option	option
	Anodized aluminium with thermal break	option	option	option	option
Corner	Glass fibre reinforced nylon	standard	standard	standard	standard
Panel insulation	Polyurethane foam density 45 kg/m ³ thermal conductivity 0.020 W/m ² K fire reaction class 1	standard	standard	standard	standard
	Mineral wool density 90 kg/m ³ thermal conductivity 0.037 W/m ² K (referred to 20°C) fire reaction class 0	option	option	option	option
External sheet material	Grey Plastisol covered galvanized steel	standard	standard	standard	standard
	Pre-coated galvanized steel	option	option	option	option
	Galvanized steel	option	option	option	option
	Aluminium	option	option	option	option
	AISI 304 stainless steel	option	option	option	option
Internal sheet material	Galvanized steel	standard	standard	standard	standard
	Pre-coated galvanized steel	option	option	option	option
	Grey Plastisol covered galvanized steel	option	option	option	option
	Aluminium	option	option	option	option
Base frame	Aluminium	standard (from size 1 to size 17)	standard (from size 1 to size 17)	standard (from size 1 to size 17)	standard (from size 1 to size 17)
	Galvanized steel	standard (from size 18 to size 27)	standard (from size 18 to size 27)	standard (from size 18 to size 27)	standard (from size 18 to size 27)
Handle	Glass fibre reinforced nylon	standard	standard	standard	standard
Type	Compression type	standard	standard	standard	standard
	Hinge function type (possibility to remove door)	option	option	option	option

D-AHU Easy

Construction type		DS 50	DS 25
Profile	Aluminium	Standard	Standard
Corner	Glass fibre reinforced nylon	Standard	Standard
Panel insulation	Polyurethane foam thermal conductivity 0.024 W/m ² K	Standard (density 45 kg/m ³)	standard (density 47 kg/m ³)
External sheet material	Pre-coated galvanized steel (RAL 9002)	Standard	Standard
Internal sheet material	Galvanized steel	Standard	Standard
Base frame	Aluminium	Standard	Standard
Handle	Glass fibre reinforced nylon	Standard	Standard
Type	Compression type	Standard	Standard



Daikin air handling units, with their plug-and-play design and inherent flexibility, can be configured and combined specifically to meet the exact requirements of any building, no matter what it is used for or who is to work there. Our systems are designed to be the most environmentally friendly and the most energy efficient on the market, thus reducing their ecological impact, while, at the same time, keeping costs down through the minimisation of energy consumption.

When combined with the small physical footprint of the system, these features make our air handling units ideal for all markets.

Air handling units

**Why choose Daikin
air handling units?** 434

Products overview 438

Software and Eurovent certification 438

The working principle at a glance 440

Professional 442

Energy 443

Easy 444

Modular 445

Air handling unit application 446

Options & accessories 447



Daikin air handling units

Why choose Daikin air handling units?

- Maximum energy efficiency and indoor air quality
- Wide range of functions and options
- **High quality** in component selection
- **Innovative** technology
- Operation **efficiency** and energy **savings**
- Outstanding **reliability** and **performance**
- Various applications are possible including air conditioning applications, industry-type process cooling, and large-scale district heat source systems.

Benefits for the installer

- › Simple precise commissioning through pre-programmed DDC controller
- › Reduced installation time thanks to internal electrical wiring and external terminal connections avoiding drilling into unit panels
- › Flush mounted electrical control panel avoiding risk of damage during transport and installation

Benefits for the consultant

- › Quick selection tool - in-house developed ASTRA software with improved user interface allowing for a professional report in a few clicks
- › Unlimited configuration options

Benefits for the end user

- › Energy efficient controls, allowing the user to determine a wide range of settings, resulting in excellent operational flexibility
- › Safe operation - fully integrated electrical panel for units taller than 80cm

Marketing tools

- › Watch the time-lapse video of a Daikin AHU construction on www.youtube.com/daikineurope
- › Download our brochure on air handling units as a combined solution with refrigeration and chillers on commercial applications



Packaged control solution for Daikin AHU

- › Electrical control panel complete with Direct Digital Control (DDC) controller
- › Internal fitting of all sensors and pressure measurement devices
- › Built-in temperature, humidity and CO₂ sensors
- › Internal electrical wiring for all components

Energy efficient while focusing on maximum comfort

- › Set points can be specified for supply, return or room temperature
- › Precise control of all AHU components such as mixing dampers, heat recovery wheels, water valves, pressure switches for filters and fans, fan motors and inverters

Plug and play design

- › Low voltage fast connectors in between AHU sections

Easy start-up and commissioning

- › Pre-programmed and factory-tested controls ensuring all wiring is installed correctly
- › Reduced energy and operating costs

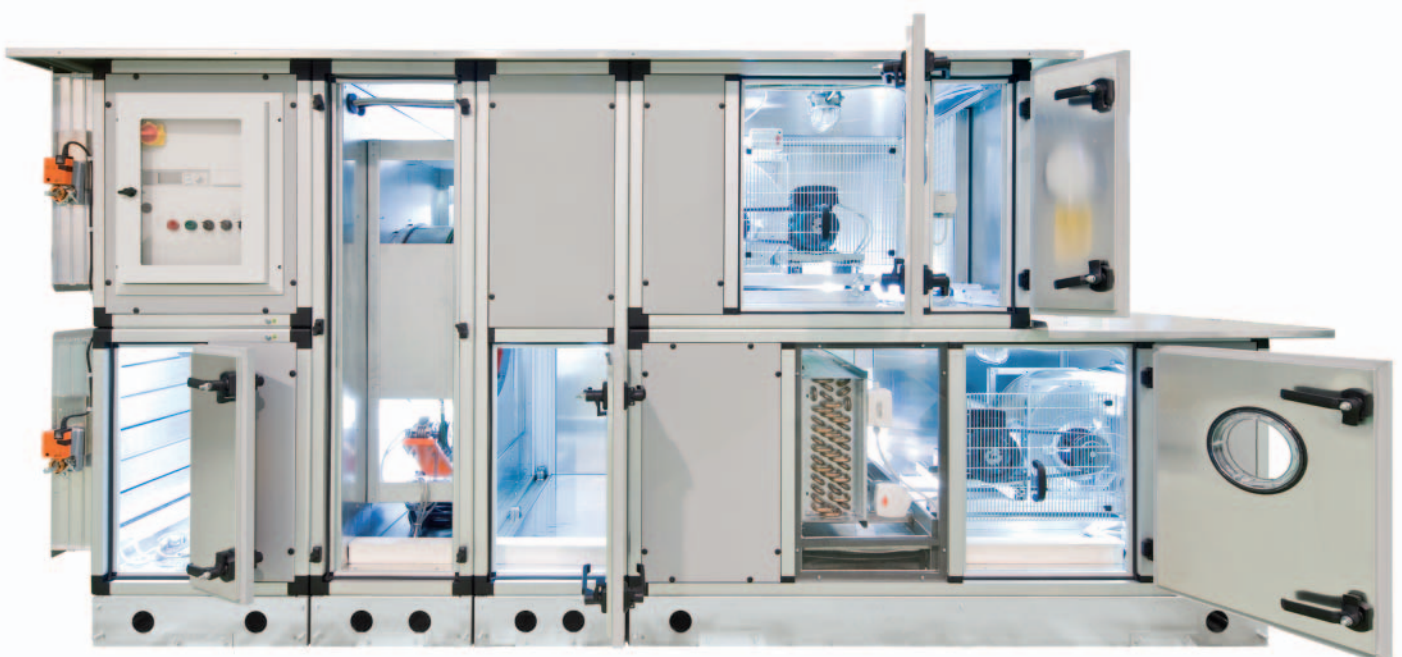



SMART CONTROLS



DAMPER AND EC FAN



HEAT RECOVERY WHEEL AND FILTER



COMMERCIAL AND INDUSTRIAL APPLICATIONS



COMFORTABLE INDOOR CLIMATE



Overview D-AHU range

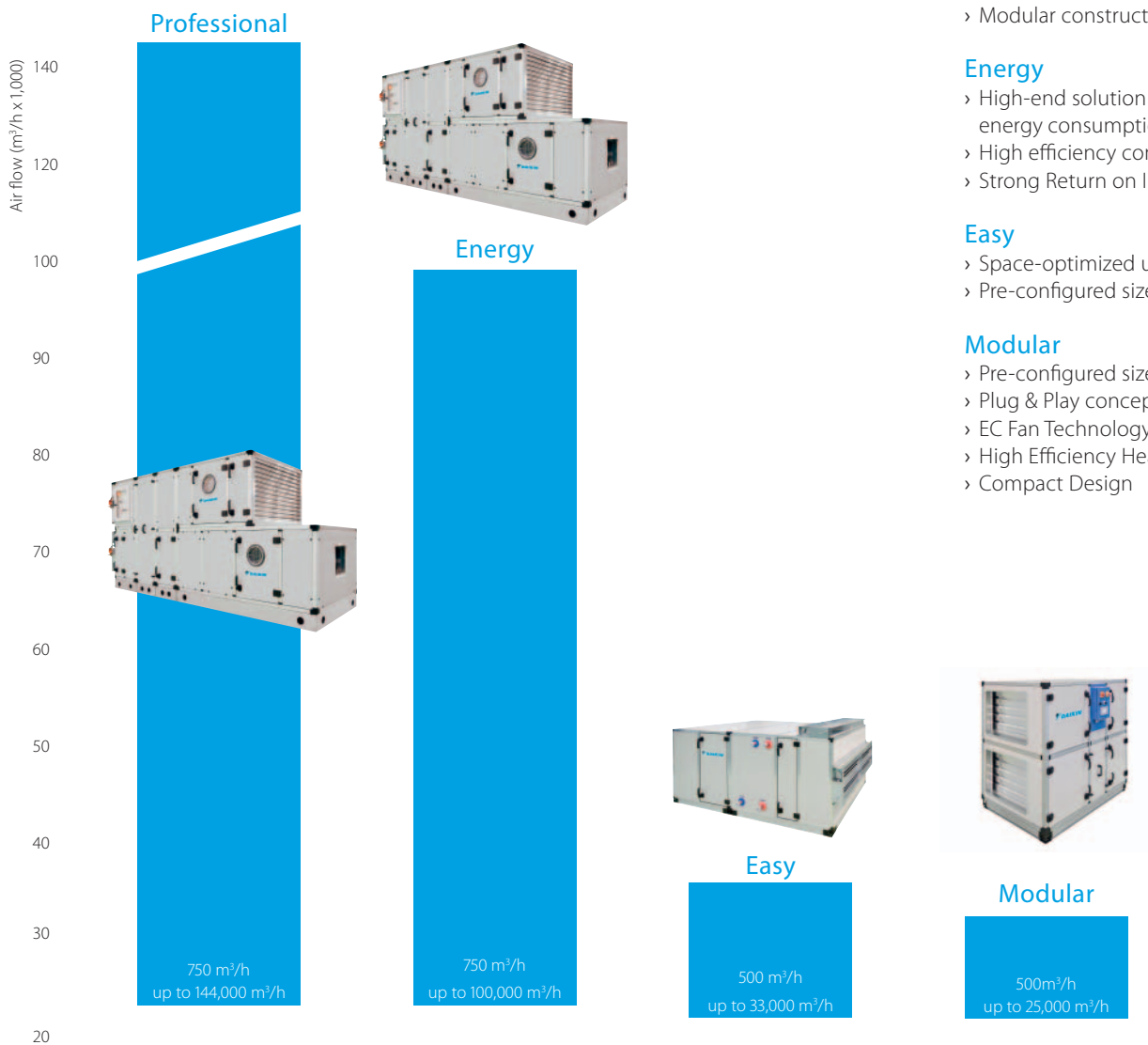

Professional

- › Pre-configured sizes
- › Tailored to the individual customer
- › Modular construction

Energy

- › High-end solution for optimised energy consumption
- › High efficiency components
- › Strong Return on Investment

Easy

- › Space-optimized unit
- › Pre-configured sizes

Modular

- › Pre-configured sizes
- › Plug & Play concept
- › EC Fan Technology
- › High Efficiency Heat Wheel
- › Compact Design

Software

ASTRA Pro

ASTRA is the powerful software that Daikin has developed to offer a **quick** and **comprehensive service** for the customer in order to make the technical choice and the **economic valorization** of each air handling unit. It is a complete tool that can configure any type of product and respond exactly to the strictest design needs. The result is a comprehensive **economic** offer including all the technical data and drawings, the psychrometric diagram with the relative air treatment and the fans' performance curves. However, Daikin didn't stop there, they went further.

MECCANO is the other powerful software developed and designed to quickly **convert the offer in the executive order**. Technical drawings to be sent and approved by the client, executive drawings for the production, bill of material, code generation for each component used are just a few of the many functions of the instrument.

The ASTRA-MECCANO integration has therefore made possible the complete automated management of the process by **reducing the time of the offer** and of the delivery and improving the service to our customers.

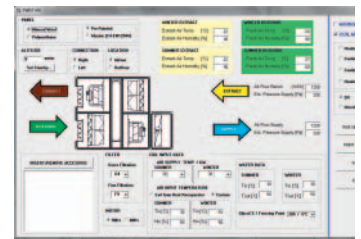
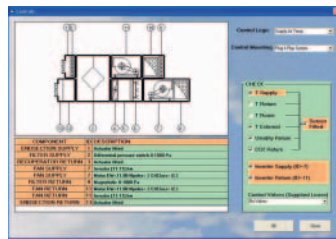

ASTRA Xpress

- › Quick AHU selection that will save you precious time, drastically reducing selection time through the new software interface.
- › Very competitive solution available within the Wizard thanks to pre-uploaded parameters.
- › High selection quality, thanks to the huge number of the pre-engineered units embedded within the software.

4 steps to configure an air handler in just 2 minutes

- 1 Select a configuration
- 2 Select coils
- 3 Select other components
- 4 Design conditions ----> Print report

Eurovent certification

Daikin Applied Europe S.p.A. participates in the Eurovent Certified Performance programme for Air Handling Units.

Check ongoing validity of certificate:
www.eurovent-certification.com
www.certiflash.com



Result sp65	Eurovent Classification according to EN1886				
D1	Casing strength class Max. relative deflection mm x m ⁻¹	D1 4.00	D2 10.00	D3 EXCEEDING10	
L1	Casing air leakage class at -400 Pa Max. leakage rate (f ₄₀₀) l x s ⁻¹ x m ⁻²	L1 0.15	L2 0.44	L3 1.32	
L1	Casing air leakage class Max. leakage rate (f ₇₀₀) l x s ⁻¹ x m ⁻²	L1 0.22	L2 0.63	L3 1.90	
F9	Filter bypass leakage class Max. filter bypass leakage rate k in % of the volume flow rate	F9 0.50	F8 1	F7 2	F6 4
T2	Thermal transmittance (U) W/m ² x K	T1 U <= 0.5	T2 0.5 < U <= 1	T3 1 < U <= 1.4	T4 1.4 < U <= 2
TB2	Thermal bridging factor (kb) W x m ⁻² x K ⁻¹	TB1 0.75 < K _b <= 1	TB2 0.6 < K _b <= 0.75	TB3 0.45 < K _b <= 0.6	TB4 0.3 < K _b <= 0.45
				T5 No requirements	TB5 No requirements

The working principle at a glance

Typical configurations for Daikin air handling units provide a versatile range of functions. Our system offers numerous options for customisation through an extensive range of variations and added functionality.

Supply side

- 1 Damper section including ventilation grilles, factory-mounted actuators
- 2 Bag filter with factory-mounted differential pressure manometer and hinged door
- 3 Heat recovery system (plate heat exchanger or rotation heat exchanger)
- 4 Mixing box with damper and factory-mounted actuators
- 5 R-410A with heat recovery system with galvanised condensate tray and drip protection
- 6 Supply air fan (with hinged door, opening, drive monitoring, mounted and cabled lighting and ON/OFF switch)

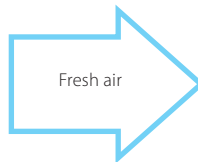
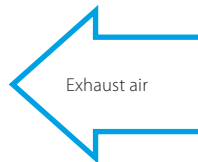

Fans

- › Forward curved fan
- › Backward curved fan
- › Backward airfoil blades fan
- › Plug fan
- › EC plug fan

Exchangers

- › Water coils
- › Steam coils
- › Direct expansion coil
- › Superheated water coils
- › Electric coils

Humidifiers

- › Evaporative humidifier without pump (loss water)
- › Evaporative humidifier with re-circulating pump
- › Air washer without pump (loss water)
- › Air washer with re-circulating pump
- › Steam humidifier with direct steam production
- › Steam humidifier with local distributor
- › Atomized water spray humidifier

Control system on plug and play solution basis

- › Air temperature control
- › Chilled water and DX cooling system control
- › Free cooling
- › CO₂ automatic control

Unique section to section thermal break profile

- › Thermal bridge free for the entire AHU
- › Smooth interior surface with improved IAQ (Indoor Air Quality)

Conventional design

Daikin design

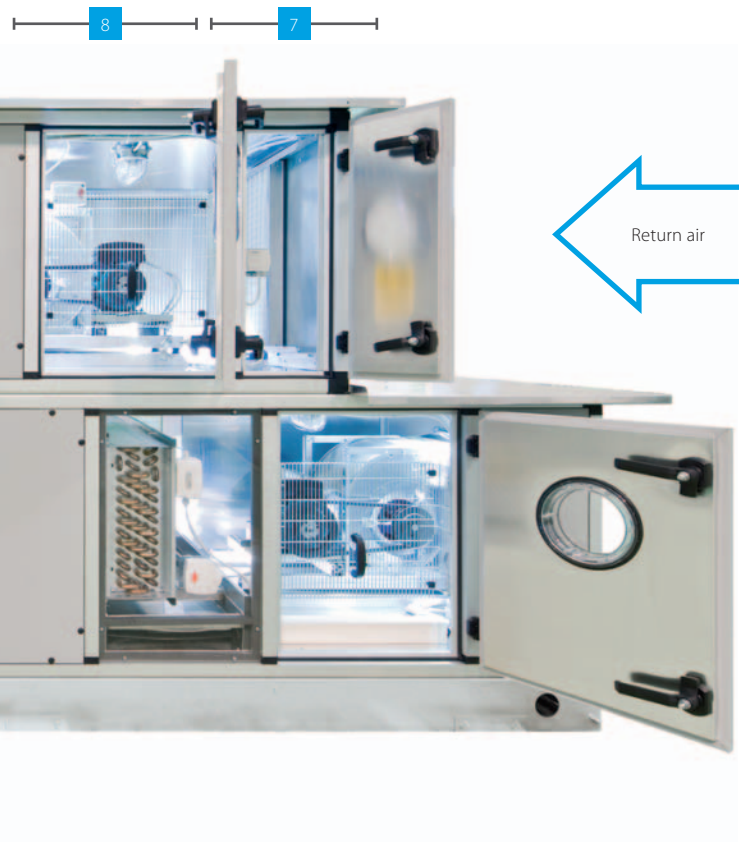
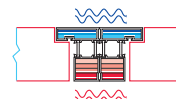
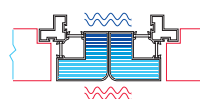

Return side

- 7** Bag filter with factory-mounted differential pressure manometer and hinged door.
- 8** Exhaust air fan (with hinged door, opening, drive monitoring, mounted and cabled lighting and ON/OFF switch)
- 9** Mixing box with damper and factory-mounted actuators
- 10** Heat recovery system (plate heat exchanger or rotation exchanger)
- 11** Damper section including ventilation grilles, factory-mounted actuators

Heat recovery systems

- › Heat wheel, sensible or sorption
- › Plate heat exchanger (optional bypass)
- › Run-around coils

Other section

- › Attenuator section
- › Mixing box section with actuators or manual controlled dampers
- › Empty section

Filters

- › Synthetic pleated filter
- › Flat filter aluminium mesh
- › Rigid bag filter
- › Soft bag filter
- › High efficiency filter
- › Carbon absorption filter
- › Carbon deodorizing filter

Accessories

- › Control features
- › Frost protection
- › Manometers
- › Drive guard
- › Roof
- › ...

Professional

Flexible solution for custom applications

Flexible design

Daikin Professional air handlers are available in 27 pre-defined configurations, optimized for the most cost-effective selection and manufacturing standardization.

- > Airflow from 500 m³/h up to 144,000 m³/h
- > All the sizes are modularly manufactured to facilitate the transport and the assembly on site.



Variable dimensioning

Size	Airflow (m ³ /h)	Height - mm	Width - mm
1	1,105	550	850
2	1,550	600	900
3	1,980	650	950
4	2,600	780	1,100
5	3,170	780	1,150
6	3,550	800	1,150
7	4,000	800	1,250
8	4,800	850	1,300
9	5,560	900	1,350
10	6,600	900	1,550
11	7,950	1,100	1,550
12	9,320	1,100	1,650
13	10,050	1,150	1,650

Size	Airflow (m ³ /h)	Height - mm	Width - mm
14	13,200	1,400	1,850
15	19,200	1,500	2,100
16	25,300	1,580	2,650
17	31,500	1,750	2,750
18	37,000	1,800	3,240
19	43,400	2,100	3,090
20	51,300	2,250	3,340
21	58,000	2,250	3,820
22	67,500	2,400	4,040
23	78,000	2,450	4,490
24	84,700	2,700	4,490
25	98,000	2,850	4,890
26	111,000	2,850	5,490
27	124,000	3,000	5,990

Example

Airflow (m ³ /h)	Unit Size	Height (mm)	Width (mm)	Face Velocity (m/s)
15,000	STD 15	1,500	2,100	1.95
	1,500x1,750	1,500	1,750	2.46

- > 1 cm increment for width & height dimensions
- > No additional cost for customized unit size
- > No additional lead time

Plug and play: More control, more flexibility

The plug and play control system allows for more precise control than ever before, allowing the user to determine a wide range of settings, resulting in excellent operational flexibility.

The factory-fitted electrical control panel, complete with Direct Digital Control (DDC) is combined with in-built temperature, humidity and CO₂ sensors to control mixing dampers, heat recovery wheels, water valves, pressure switches

for filters and fans, fan motors and inverters.

All these components are wired internally and individual AHU modules are linked by fast connectors.

The AHU control system can manage the chilled water coil, hot water coil, DX cooling and/or heating coil(s) (in conjunction with ERQ/VRV) of single or multiple refrigerant circuits (up to a maximum of four circuits per DX coil).

Energy

High-end solution for the highest energy efficiencies

High efficiency heat recovery

The D-AHU Energy series is equipped with high efficiency heat recovery system with rates up to 90%. Various models are available with a heat recovery system equipped with a condensation wheel, an enthalpy wheel or a sorption wheel.

Return on investment

An air handling unit is critical to an effective climate control system and, although the initial investment can appear high, the savings generated by our advanced designs and operating efficiencies guarantee a rapid return on the investment made. Our D-AHU Energy series has been designed to deliver exceptional performance thus driving down the energy consumed and so lowering energy bills. Taken over the expected 15-year life-span of the equipment, this will result in an enormous saving, especially in a time of ever increasing energy prices.



Premium efficiency motor

Premium efficiency motors in line with EU regulation (EC) no. 640/2009 are available for the Energy series in order to further reduce electrical power consumption.

High efficiency fan

Fans with double-width, double-inlet and backward curved airfoil blades are available with efficiencies of up to 85% as well as reinforced bearings for longer lifespan.

Specific Fan Power (SFP) is a measure used in the evaluation of the energy consumed by an air handling unit. In other words, the lower the SFP, the lower the power consumption of the entire air handler. Thanks to very efficient components our Energy series can provide just that.

Plug and play controls

Daikin has developed a control system to efficiently manage all components selected either independently or through an external supervision system. The control package includes the control panel, advanced microprocessor and in-built sensors for temperature, humidity and air quality.

Easy

Quick solution for climate control

The range covers an area of airflow rates from 500 m³/h up to 33,000 m³/h*, with the possibility to choose the more appropriate face velocity, depending on the treatment required.

Fifteen predefined configurations optimized to reach the best compromise between competitiveness and manufacturing standardization.

Quick and easy installation

Designed to overcome installation constraints where space requirements of the section "height x width" must be adapted to the available space. The Easy series of air handling units allow to tailor the unit sizes through increments of 1 cm average.



Size	Airflow (m ³ /h)	Height (mm)	Width (mm)
Std 1	1,105	550	850
Std 2	1,550	600	900
Std 3	1,980	650	950
Std 4	2,600	780	1,100
Std 5	3,170	780	1,150
Std 6	3,550	800	1,150
Std 7	4,000	800	1,250
Std 8	4,800	850	1,300
Std 9	5,560	900	1,350
Std 10	6,600	900	1,550
Std 11	7,950	1,100	1,550
Std 12	9,320	1,100	1,650
Std 13	10,050	1,150	1,650
Std 14	13,200	1,400	1,850
Std 15	19,200	1,500	2,100

Example

Airflow (m ³ /h)	Unit Size	Height (mm)	Width (mm)	Face Velocity (m/s)
15,000	STD 15	1,500	2,100	1.95
	1,500x1,700	1,500	1,700	2.48

Infinitely variable sizes

Flexible sizing for AHU optimization

- › 1 cm increment for width & height dimensions
- › No additional cost for non-standard unit size
- › No additional lead time

*Airflow limits of 500 m³/h and 33,000 m³/h are calculated using non standard sizes (max dimensions 2,150x2,150) and considering 2.5 m/s coil face velocity

D-AHU Easy 1-8

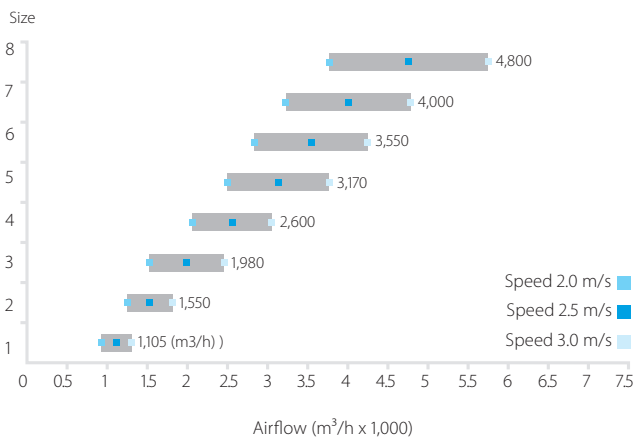

D-AHU Easy 9-15

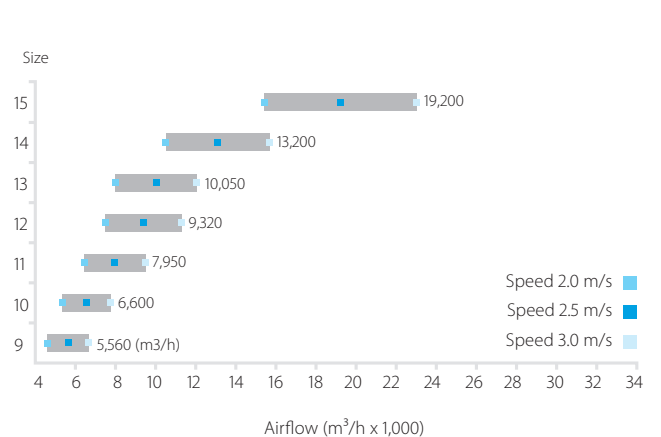

Modular

High-end solution with heat recovery

Energy efficiency and indoor air quality

- › Predefined sizes
- › IE4 premium efficiency motor
- › High efficiency heat wheel (heat recovery)
- › Compact design
- › Advanced control features
- › Easy installation
- › Indoor air quality compliant with VDI 6022 hygiene guideline
- › Operating limits from -25 °C, -40 °C with electric heaters, up to +46 °C ambient temperature
- › VRV IV and ERQ coupling capability
- › Indoor and outdoor versions
- › Free cooling capability
- › Economy and Night mode operation
- › Monitoring and control through Daikin ITM



EC Fan

- › Air flow or pressure control (Variable Air Volume - Constant Air Volume)
- › Nominal air flow programmed at factory
- › Silent operation

Simple, quick installation

The Modular series' Plug & Play design is more than just a convenient feature for installers. It offers cost-saving benefits as there is no need for expensive adjustments before the unit is commissioned. Plug & Play makes everyone's life simpler, safer and more economical.

		ADT-F/B	1	2	3	4	5	6	7	8	9	10
Airflow		m ³ /h	1,200	1,700	2,700	4,100	5,500	6,100	7,000	9,100	11,500	15,000
Temp. efficiency winter		%	81.3	81.1	81.2	81.6	80.7	81.2	82.7	81.8	81.5	81.9
External static pressure	Nom.	Pa	200	200	200	200	200	200	200	200	200	200
	Nom.	A	2.66	3.90	6.30	2.98	4.00	4.74	4.76	6.34	8.72	10.2
Power input	Nom.	kW	0.62	0.89	1.50	1.98	2.68	2.96	3.30	4.28	5.48	7.04
	SFPv	kW/m ³ /s	1.87	1.89	1.99	1.74	1.75	1.75	1.70	1.69	1.72	1.69
Electrical supply	Phase	ph	1	1	1	3+N	3+N	3+N	3+N	3+N	3+N	3+N
	Frequency	Hz	50	50	50	50	50	50	50	50	50	50
	Voltage	V	230	230	230	400	400	400	400	400	400	400
Dimensions unit	Length	mm	1,700	1,700	1,800	1,920	2,080	2,280	2,400	2,450	2,280	2,400
	Depth	mm	720	820	990	1,200	1,400	1,400	1,600	1,940	1,940	2,300
	Height overall	mm	1,320	1,320	1,540	1,740	1,740	1,920	1,920	2,180	2,460	2,570
Weight unit		kg	325	350	475	575	750	790	950	1,330	1,410	1,750
Sound level		Lp dB(A)*	40	42	42	45	46	44	43	43	45	45

* Sound pressure level radiated from unit at 1 meter and according to ISO 3744 (supply outlet ducted)

Air handling unit application

Daikin Fresh Air package

The Daikin fresh air package provides a complete solution, including all unit controls (expansion valve, control box and AHU controller) and sensors factory mounted and configured.

This unique solution allows for plug and play connection of our AHU series to Daikin ERQ and VRV condensing units.

High efficiency

Daikin heat pumps are renowned for their high energy efficiency. Integrating the AHU with a heat recovery system is even more effective since an office system can frequently be in cooling mode while the outdoor air is too cold to be brought inside in an unconditioned state. In this case heat from the offices is merely transferred to heat up the cold incoming fresh air.

High comfort levels

Daikin ERQ and VRV units respond rapidly to fluctuations in supply air temperature, resulting in a steady indoor temperature and resultant high comfort levels for the end user. The ultimate is the VRV range which improves comfort even more by offering continuous heating, also during defrost.

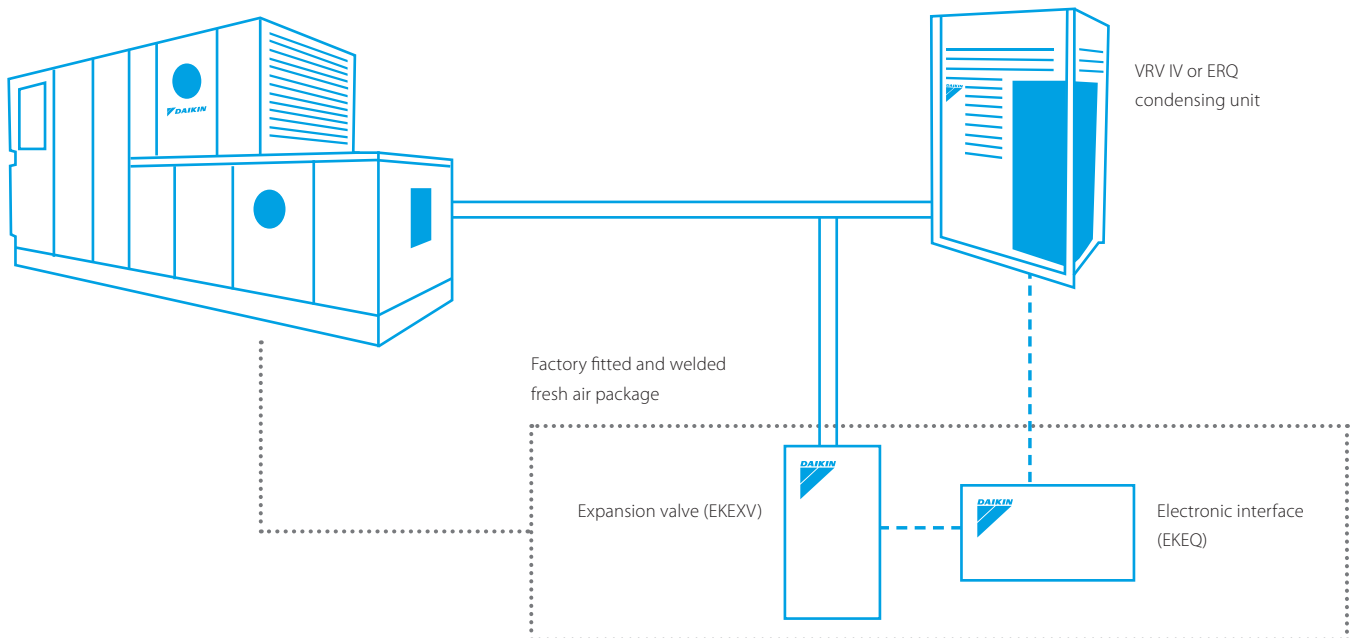

For more information on the connection of VRV or ERQ DX units with air handling units refer to the chapter Ventilation & Biddle air curtains of this catalogue

D-AHU Professional

Construction type		SP 65	SP 45	FP 50	FP 25
Profile	Aluminium	standard	standard	standard	standard
	Anodized aluminium	option	option	option	option
	Aluminium with thermal break	option	option	option	option
	Anodized aluminium with thermal break	option	option	option	option
Corner	Glass fibre reinforced nylon	standard	standard	standard	standard
Panel insulation	Polyurethane foam density 45 kg/m ³ thermal conductivity 0.020 W/m*K fire reaction class 1	standard	standard	standard	standard
	Mineral wool density 90 kg/m ³ thermal conductivity 0.037 W/m*K (referred to 20°C) fire reaction class 0	option	option	option	option
External sheet material	Grey Plastisol covered galvanized steel	standard	standard	standard	standard
	Pre-coated galvanized steel	option	option	option	option
	Galvanized steel	option	option	option	option
	Aluminium	option	option	option	option
	AISI 304 stainless steel	option	option	option	option
Internal sheet material	Galvanized steel	standard	standard	standard	standard
	Pre-coated galvanized steel	option	option	option	option
	Grey Plastisol covered galvanized steel	option	option	option	option
	Aluminium	option	option	option	option
Base frame	AISI 304 stainless steel	option	option	option	option
	Aluminium	standard (from size 1 to size 17)	standard (from size 1 to size 17)	standard (from size 1 to size 17)	standard (from size 1 to size 17)
	Galvanized steel	standard (from size 18 to size 27)	standard (from size 18 to size 27)	standard (from size 18 to size 27)	standard (from size 18 to size 27)
Handle	Glass fibre reinforced nylon	standard	standard	standard	standard
Type	Compression type	standard	standard	standard	standard
	Hinge function type (possibility to remove door)	option	option	option	option

D-AHU Easy

Construction type		DS 50	DS 25
Profile	Aluminium	Standard	Standard
Corner	Glass fibre reinforced nylon	Standard	Standard
Panel insulation	Polyurethane foam thermal conductivity 0.024 W/m*K	Standard (density 45 kg/m ³)	standard (density 47 kg/m ³)
External sheet material	Pre-coated galvanized steel (RAL 9002)	Standard	Standard
Internal sheet material	Galvanized steel	Standard	Standard
Base frame	Aluminium	Standard	Standard
Handle	Glass fibre reinforced nylon	Standard	Standard
Type	Compression type	Standard	Standard

A woman with curly hair, wearing a blue cardigan and jeans, is crouching next to a large glass display refrigerator in a store. She is looking at the contents of the refrigerator, which are mostly packaged produce. The refrigerator is part of a long row of similar units. The scene is lit with cool, blue-toned lights, creating a clean and modern atmosphere. A semi-transparent blue box is overlaid on the left side of the image, containing text.

Daikin offers a wide range of condensing units for cooling and freezing applications. Daikin refrigeration units combine efficiency and reliability with easy installation and maintenance.

Refrigeration

Why choose Daikin refrigeration? 450

Products overview 454

ZEAS condensing unit 456
LREQ-BY1 458

Conveni-Pack 460
LRYEQ-AY1 462

Booster unit 463
LCBKQ-AV1 463

Commercial condensing units 464
JEHCCU-CM1/3 464
JEHSCU-CM1/3 465
JEHCCU-M/L & JEHSCU-M/L 466

Industrial condensing unit 467
ICU 467

Options & accessories 468



Why choose Daikin refrigeration?

- **High efficient** solutions to match your refrigeration needs
- For all types of **commercial and industrial** applications
- Innovative and reliable VRV technology: proven and tested for ZEAS and CONVENI-PACK
- Compliant with **new F-Gas regulation** (R-410A)
- Proven refrigeration technology with over 3,000 R-410A field installations in Europe
- Urban proof solutions in terms of **compact dimensions** and **low sound levels**

Benefits for the installer

- › Plug and play solutions
- › Pre-charged and factory-tested
- › Compact design for restricted installation space

Benefits for the consultant

- › Daikin ZEAS identified as best available technology according to Eco-design
- › Easy and intuitive selection of outdoor condensing units with Refrigeration Xpress
- › Wide range to match most refrigeration needs according to F-gas Regulation according to F-gas Regulation

Benefits for the end user

- › High efficiency technology for high ROI
- › Heat recovery technology on Conveni-Pack
- › Proven reliability and high performance
- › Ideal for urban applications

Selection software

Visit the website: www.daikineurope.com/refrigeration
 Download the selection software Refrigeration Xpress from the business portal.

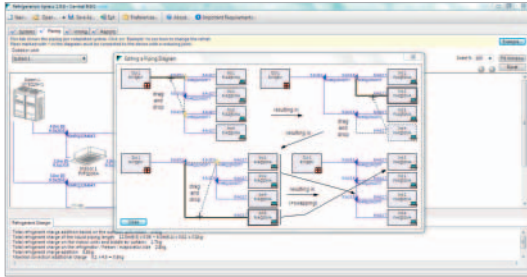

F-Gas compliant

Daikin refrigeration units are ready to meet the targets of the new F-Gas regulation.

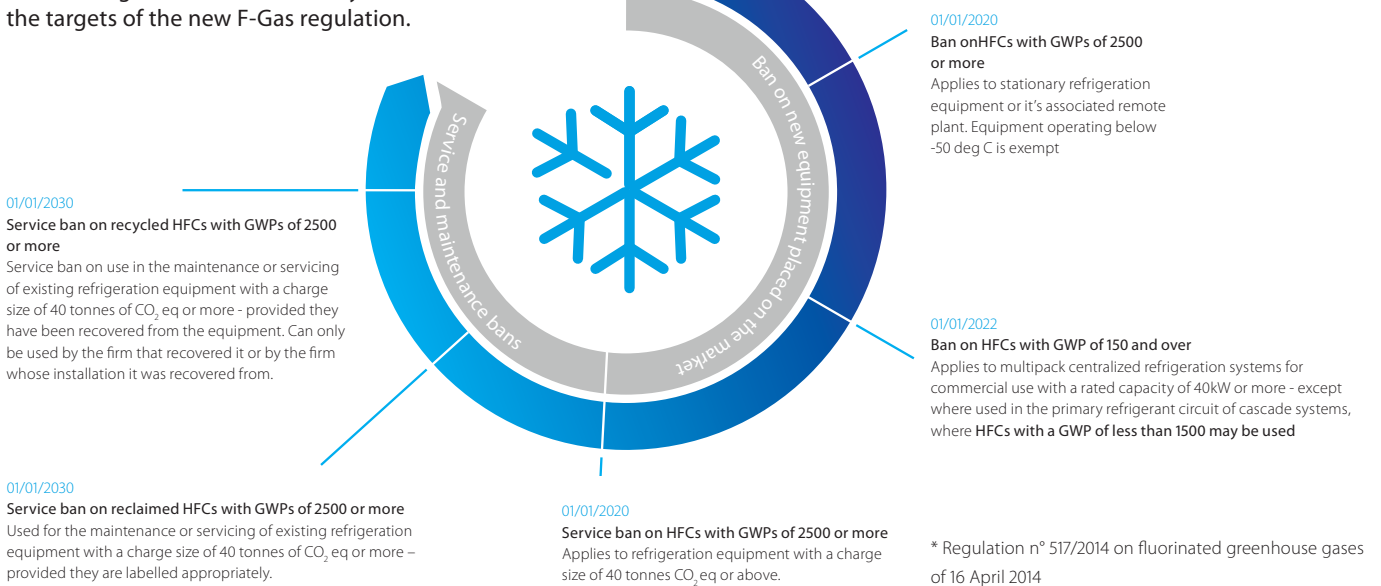

References



"We wanted a future-proof, energy efficient and proven technology with high reliability."
 Bakery cooperative, Germany



"With Conveni-Pack, we have a complete and totally reliable solution for all our heating and air conditioning needs, as well as for refrigerating all our fresh and frozen products."
 Food store, Austria



In a German supermarket Conveni-Pack teams up with ZEAS to supply service counters, fridges, an air curtain and indoor A/C units, a cooling storage room and deep-freeze cabinets.



ZEAS (LREQ-BY1)



ZIGGO DOME, EVENT HALL
ZEAS FOR COOLING (6) AND FREEZING (2)



CHILLED WITH ZEAS



BÄKO WEST EG, BAKERY CO-OPERATIVE
ZEAS FOR COOLING (6) AND FREEZING (6)









E. LECLERC, HYPERMARKET
ZEAS



EDEKA, SUPERMARKET
CONVENI-PACK (2) AND ZEAS (1)

Products overview



Model	Product name	Capacity (kW)	0	2	5	10	25	50	100	150	300	450
Inverter condensing unit for commercial refrigeration	ZEAS LREQ-BY1											
Integrated solution for chilling, freezing and comfort cooling and heating	Conveni-Pack LRYEQ-AY1											
Booster unit to allow both ZEAS and Conveni-Pack freezing applications	Booster unit LCBKQ-AV1											
Commercial condensing units with reciprocating technology	CCU JEHCCU-M1/M3/L1/L3 JEHCCU-CM1/CM3											
Commercial condensing units with scroll technology	SCU JEHSCU-M1/M3/L3 JEHSCU-CM1/CM3											
Condensing unit for industrial refrigeration	ICU ICUHS-HA											

Indoor units and Biddle air curtains for connection to Conveni-Pack

Capacity class (kW)

Model	Product name		50	63	71	80	100	125	140	200	250
Cooling capacity (kW) ¹			5.6	7.1	8.0	9.0	11.2	14.0	16.0	22.4	28.0
Heating capacity (kW) ²			6.3	8.0	9.0	10.0	12.5	16.0	18.0	25.0	31.5
Round flow cassette	FXFQ-A		•	•		•	•	•			
2-way blow ceiling mounted cassette	FXCQ-A		•	•		•		•			
Ceiling mounted corner cassette	FXKQ-MA			•							
Concealed ceiling unit with inverter driven fan	FXSQ-PA		•	•		•	•	•			
Concealed ceiling unit with inverter driven fan	FXMQ-P7		•	•		•	•	•			
Large concealed ceiling unit	FXMQ-MA									•	•
Ceiling suspended unit	FXHQ-A			•			•				
4-way blow ceiling suspended unit	FXUQ-A				•		•				
Floor standing unit	FXLQ-P		•	•							
Concealed floor standing unit	FXNQ-P		•	•							

Capacity class (kW)

Model	Product Name		80	100	125	140	200	250
Heating capacity (kW) ²			7.4 - 9.2	11.6 - 13.4	15.6	16.2 - 19.9	29.4	29.4 - 31.1
Biddle air curtain free hanging	CYVS-DK		•	•	•	•	•	•
Biddle air curtain cassette	CYVM-DK		•	•	•	•	•	•
Biddle air curtain recessed	CYVL-DK		•	•	•	•	•	•

¹ Nominal cooling capacities are based on: indoor temperature: 27°CDB / 19°CWB, outdoor temperature: 35°CDB, piping length: 7.5m, level difference: 0m

² Nominal heating capacities are based on: indoor temperature: 20°CDB, outdoor temperature: 7°CDB / 6°CWB, piping length: 7.5m, level difference: 0m

³ Optional



ZEAS condensing unit for refrigeration

Why choose ZEAS?

- High energy efficiency
 - › Daikin inverter scroll compressor with economizer technology
 - › DC inverter fan technology
- Reliable operation
 - › Error-proof component selection
 - › Factory leak-tested and pre-charged
- Small foot print and low weight
 - › Very compact design
 - › Easy to install, even in small spaces
- Comfort
 - › Quiet operation
 - › High grade sound insulation on both panels and compressors
 - › Specially designed fan blades to limit sound emissions
 - › 4 low sound operation settings including night mode
- Intelligent control
 - › Unit can be connected to a 3rd party monitoring system
 - › Remote control of target evaporation temperature and error reset

Benefits for installers

- › Reduced delivery time thanks to European manufacturing plant
- › Reduced piping requirements and installation time
- › Integrated electrical & control box
- › Unit already pre-charged with refrigerant

Benefits for consultants

- › One model can cover for most refrigeration needs in the market
- › Wide capacity range
- › High modularity of the refrigeration system
- › Suitable to indoor installations through the use of high ESP fans

Benefits for end users

- › Energy consumption is cut by 10 to 35% compared to traditional refrigeration equipment
- › Small footprint and low weight requiring only light weight supporting structures
- › A neighbourhood-friendly choice with its special night operation mode

Marketing tools

- › See how transportation is simulated and vibrations are tested on our shaker (search: vibration ZEAS)
- › Watch why a Dutch culture and entertainment venue chose ZEAS for its beverage cooling (search: Energiehuis ZEAS) www.youtube.com/DaikinEurope



Refrigeration Xpress selection software

- › User-friendly, easy to understand design software for Conveni-Pack and ZEAS. Its detailed report includes a list of materials, piping and wiring diagrams, and device options

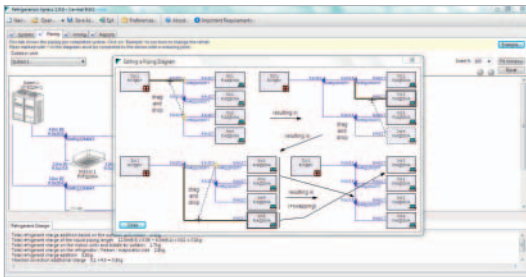

Literature

- › Check the overview of all our literature for our professional network and end-customers www.daikineurope.com/support-and-manuals/catalogues



NEW Business portal

- › Experience our new extranet that thinks with you at my.daikin.eu
- › Find information in seconds via a powerful search
- › Customise the options so you see only info relevant for you
- › Access via mobile device or desktop

Internet

- › See which solutions we have for your refrigeration application via the link below www.daikineurope.com/commercial/applications
- › See an overview of our references www.daikineurope.com/references
- › Get more commercial details on our flagship products www.daikineurope.com/minisite/zeas/



ZEAS condensing unit for commercial refrigeration with scroll technology

Refrigeration solution for medium to large capacity applications featuring proven VRV technology

- › Perfect solution for all cooling and freezing applications with variable load conditions and high energy efficiency requirements. In particular used in supermarkets, cold storage, blast coolers and freezers etc.
- › DC inverter scroll compressor with economiser function results in high energy efficiency and reliable performance
- › Factory tested and pre-programmed for quick and easy installation and commissioning
- › Increased installation flexibility thanks to limited dimensions
- › Low sound level including „night mode“ operation
- › For small freezing capacity, single ZEAS units can be connected to a booster unit
- › Dedicated unit to allow multi combination of 2 x 15 HP or 2 x 20 HP resulting in less pipework or installation time



Medium and Low Temperature Refrigeration				LREQ-BY1	5	6	8	10	12	15	20		
Refrigerating capacity	Medium temperature	Nom.	kW	12.5 (1)	15.2 (1)	19.8 (1)	23.8 (1)	26.5 (1)	33.9 (1)	37.9 (1)			
	Low temperature	Nom.	kW	5.51 (2)	6.51 (2)	8.33 (2)	10.0 (2)	10.7 (2)	13.9 (2)	15.4 (2)			
Power input	Medium temperature	Nom.	kW	5.10 (1)	6.56 (1)	8.76 (1)	10.6 (1)	12.0 (1)	15.2 (1)	17.0 (1)			
	Low temperature	Nom.	kW	4.65 (2)	5.88 (2)	7.72 (2)	9.27 (2)	9.89 (2)	12.8 (2)	14.1 (2)			
Dimensions	Unit	Height	mm	1,680									
		Width	mm	635				930				1,240	
		Depth	mm	765									
Weight	Unit		kg	166		242			331		337		
Heat exchanger	Type	Cross fin coil											
Compressor	Type	Hermetically sealed scroll compressor											
	Piston displacement		m ³ /h	11.18	13.85	19.68	23.36	25.27	32.24	35.8			
	Speed		rpm	5,280	6,540	4,320	6,060	6,960	5,280	6,960			
	Output		W	2,600	3,200	2,100	3,000	3,400	2,600	3,400			
	Starting method	Direct on line (inverter driven)											
Compressor 2	Speed		rpm	-		2,900			-				
	Output		W	-		3,600			-				
Compressor 3	Speed		rpm	-		-			2,900				
	Output		W	-		-			3,600				
Fan	Type	Propeller fan											
	Quantity	1											
Fan motor	Air flow rate	Cooling	Nom.	m ³ /min	95	102	171	179	191	230	240		
	Output		W	350		750			350		750		
Fan motor 2	Drive	Direct drive											
	Output		W	-		-			350		750		
Sound pressure level	Nom.		dBA	55.0 (3)	56.0 (3)	57.0 (3)	59.0 (3)	61.0 (3)	62.0 (3)	63.0 (3)			
Operation range	Evaporator	Cooling	Min.~Max.	°CDB	-45~10								
	Ambient temperature	Min.~Max.	°C	-20~43									
Refrigerant	Type	R-410A											
	GWP	2,087.5											
	Charge		kg	5.2		7.9			11.5				
			TCO ₂ eq	10.9		16.5			24.0				
Piping connections	Liquid	50m or less		ø 9.5		ø 9.5			ø 12.7				
		50~130m		ø 9.5		ø 12.7			ø 12.7				
	Gas		ø 22.2		ø 28.6			ø 34.9					
Power supply	Phase/Frequency/Voltage		Hz/V	3~/50/380-415									

				LREQ-BY1	30	40	
System	Outdoor unit module 1				LREQ15BY1R	LREQ20BY1R	
	Outdoor unit module 2				LREQ15BY1R	LREQ20BY1R	
Refrigerating capacity	Medium temperature	Nom.	kW	67.8 (1)		75.8 (1)	
	Low temperature	Nom.	kW	27.8		29.6	
Power input	Medium temperature	Nom.	kW	30.4		34.0	
	Low temperature	Nom.	kW	25.6		27.6	
Sound pressure level	Nom.		dBA	65.0		66.0	
Piping connections	Liquid					ø 19.05	
	Gas					ø 41.28	

(1) Cooling: evaporating temp. -10°C; outdoor temp. 32°C; suction SH10°C (2) Cooling: evaporating temp. -35°C; outdoor temp. 32°C; suction SH10°C (3) Sound pressure data: measured at 1m in front of unit, at 1.5m height | RLA is based on following conditions: outdoor temp. 32°CDB; suction SH 10°C; saturated temperature equivalent to suction pressure -10°C

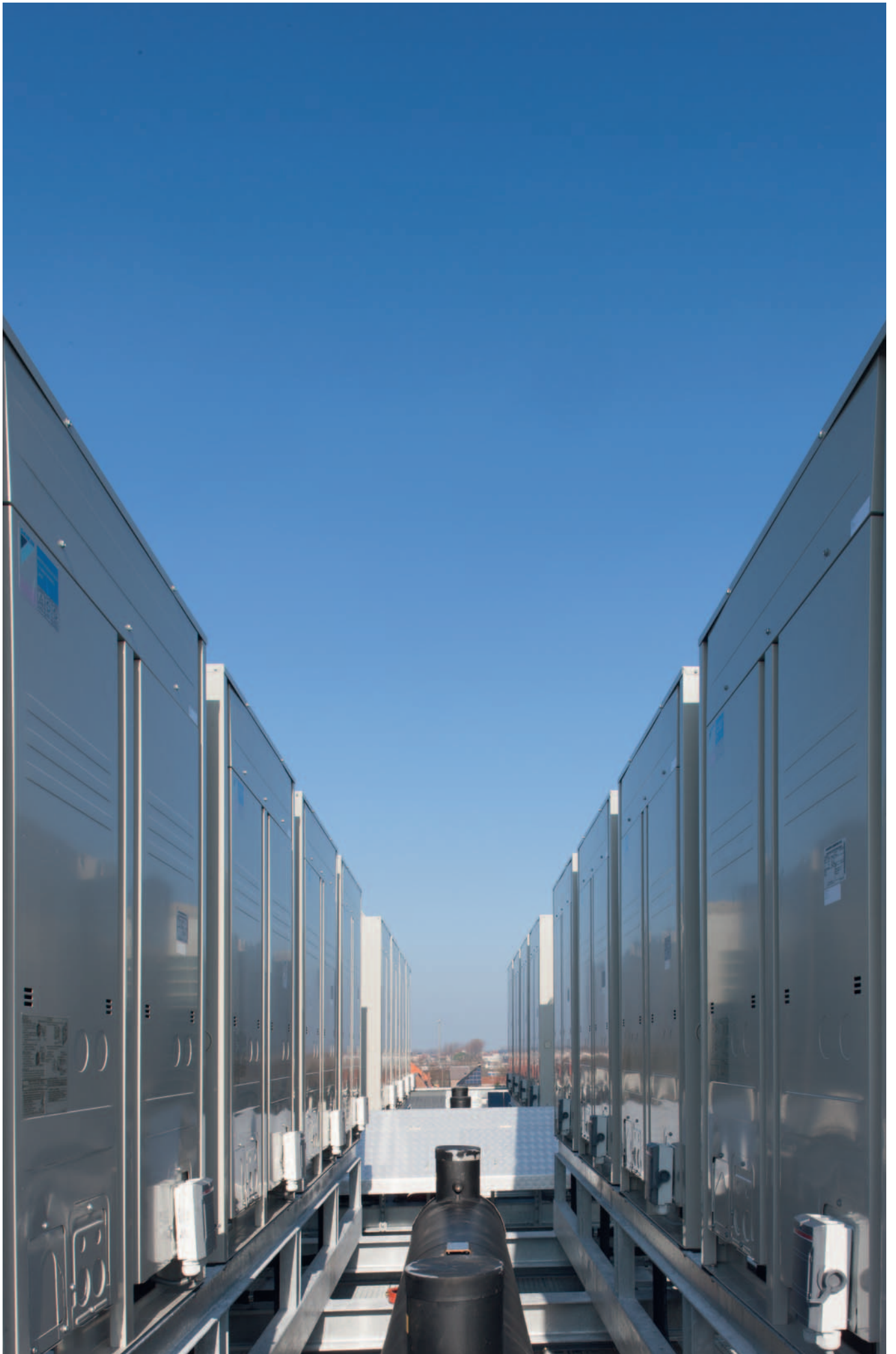



Conveni-Pack, integrated solution for refrigeration, heating and air conditioning

Why choose Conveni-Pack?

- Energy-saving combination
 - › First mass-produced, whole-building system to combine refrigeration, heating, air conditioning in one circuit
- High energy efficiency
 - › Heat recovery
 - › Savings of up to 50% on energy costs
 - › Daikin inverter scroll compressor with economizer technology
- Reliable operation
 - › Error-proof component selection
 - › Factory leak-tested and pre-charged
- Very compact design
 - › Easy to install, even in small spaces
 - › Small footprint and low weight
 - › Reduced piping requirements
- Comfort
 - › Quiet operation : Improved acoustics thanks to night operation mode, inverter control and inverter driven fans with optimised blades and grills
 - › High grade sound insulation on both panels and compressors
 - › Specially designed fan blades to limit sound emissions
 - › 4 low sound operation settings including night mode

Benefits for installers

- › Integrated electrical & control box
- › Unit already pre-charged with refrigerant
- › Established VRV technology ensuring optimised installation and maintenance

Benefits for consultants

- › Flexible system for multiple applications
- › Connectable to all grocery refrigeration applications and supplied with a wide range of air conditioning indoor units to meet shop requirements
- › Outdoor units can be positioned up to 35m above or 10m below the indoor units
- › Piping length possible up to 130m
- › Suitable for indoor installation through the use of high ESP fans

Benefits for shop owners

- › Thought design for supermarkets and smaller retail outlets
- › Maximised retail sales space available as
- › Conveni-Pack has a footprint up to 60% smaller than conventional grocery refrigeration systems
- › Reduced energy consumption by up to 50% through heat recovery
- › Quiet operation, thus ideal for densely populated urban areas

Marketing tools

Refrigeration Xpress

User-friendly design software for Conveni-Pack and ZEAS condensing units. Its detailed report includes a list of materials, piping and wiring diagrams, and device options.

Short videos

- › Visit the Daikin Europe channel YouTube for a short animation on the unique refrigeration solution Conveni-Pack
- › Discover why a Belgian petrol station owner chose Daikin for its shop comfort and refrigeration needs. www.youtube.com/DaikinEurope



Energy efficient heat recovery

- › Conveni-Pack recovers up to 100% of the heat generated by refrigeration showcases or evaporators and re-uses it to heat the retail space at no additional cost.

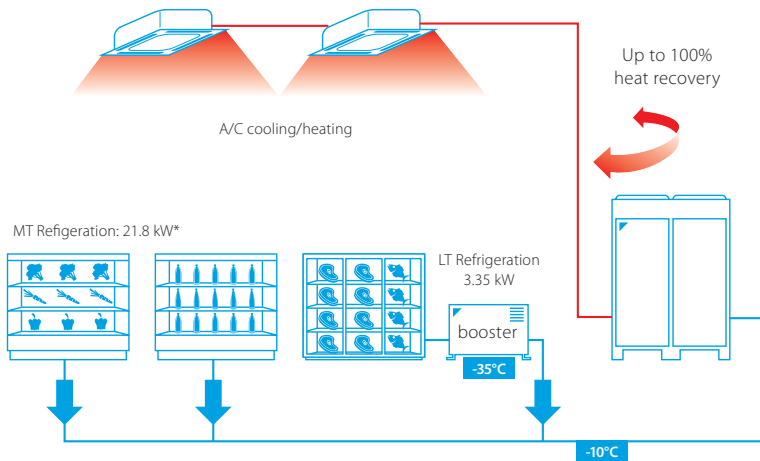

*maximum available refrigeration capacity when no booster units are connected

Reference

Edeka Buschkühle supermarket (Germany)

2 Conveni-Pack systems supply 32 meters of service counters, 12.5 meters of convenience fridges, one cooling storage room for fruit, an air curtain and 5 indoor units; the ZEAS system supplies two deep-freeze cabinets with a total capacity of 5 kW.



Discover more references on www.daikineurope.com/references

Internationally awarded

Since the introduction Conveni-Pack was recognized as innovative and environmentally – proof of which are the recent German and Irish award:

- › Winner of 2014 Institute of Refrigeration Ireland (IRI) Environmental award
- › Case: application of Carel controls to Daikin Conveni-Pack refrigeration at a Tesco store
- › Environmental Friendliness category of the Top Retail Product Awards 2014 in Germany



Conveni-Pack refrigeration system with heat recovery

Refrigeration solution for food retailers featuring award winning technology for heat recovery

- › Integrates high and low temperature refrigeration and air conditioning (including heating) into one system
- › By using heat recovery, optimised controls and state of the art compressor technology, Conveni-pack can reduce annual energy consumption up to 50% or more, compared to conventional systems
- › Lower associated CO₂ emissions thanks to the heat pump technology
- › Conveni-pack's modular design allows it to be used for smaller as well as larger shops
- › The modularity of the Conveni-pack system maximises installation flexibility. Outdoor units can be grouped into blocks or rows, or distributed around the building, to meet individual installation constraints
- › The heat extracted from the refrigeration showcases or evaporators can be re-used for comfort heating of the shop at no extra cost
- › Low sound level including „night mode“ operation



Medium Temperature Refrigeration				LRYEQ-AY1	16
Cooling capacity	Air conditioning	Nom.	kW	14.0 (1)	
	Refrigeration	Nom.	kW	21.8 (2)	
Heating capacity	Air conditioning	Nom.	kW	27.0 (3)	
	Refrigeration	Nom.	kW	21.8 (4)	
Dimensions	Unit	Height	mm	1,680	
		Width	mm	1,240	
		Depth	mm	765	
Weight	Unit		kg	370	
Heat exchanger	Type			Cross fin coil	
Compressor	Type			Hermetically sealed scroll compressor	
	Piston displacement		m ³ /h	13.34	
	Speed		rpm	6,300	
	Output		W	2,500	
	Starting method				Direct on line (inverter driven)
	Frequency ON/OFF				Less than 6 times/hour
Compressor 2	Speed		rpm	2,900	
	Output		W	3,600	
Compressor 3	Speed		rpm	2,900	
	Output		W	4,500	
Fan	Type			Propeller fan	
	Quantity			2	
	Air flow rate	Cooling	Nom. m ³ /min	230	
Fan motor	Output		W	750	
	Drive			Direct drive	
Sound pressure level	Nom.		dB(A)	62.0	
Operation range	Evaporator	Cooling	Min.-Max. °CDB	-20~-10	
	Cooling	Ambient	Min.-Max. °CDB	-5~-43	
	Heating	Ambient	Min.-Max. °CDB	-15~-21	
Refrigerant	Type			R-410A	
	GWP			2,087.5	
	Charge		kg	11.5	
	Control		TCO ₂ eq	24.0	
Piping connections	Refrigeration	Liquid	50m or less	Ø 9.5 C1220T	
			50~130m	Ø 12.7 C1220T	
	Gas	50m or less	Ø 25.4 C1220T		
		50~130m	Ø 28.6 C1220T		
Power supply	Phase/Frequency/Voltage		Hz/V	3~/50/380-415	

(1) Cooling priority mode: indoor temp. 27°CDB, 19°CWB; outdoor temp. 32°CDB; piping length: 7.5m; level difference: 0m (2) Cooling priority mode: evaporating temp. -10°C; outdoor temp. 32°CDB; Suction SH: 10°C (3) Heat recovery 100% mode: indoor temp. 20°CDB; outdoor temp. 7°CDB, 6°CWB; refrigeration load 18kW; piping length: 7.5m; level difference: 0m (4) Saturated temperature equivalent to suction pressure (refrigeration side): -10°C (under chilled condition); connection capacity for indoor air conditioner: 10HP, when heat recovery is 100%

Booster unit

- › A booster unit allows to connect freezer showcases / rooms to ZEAS and Conveni-Pack outdoor units
- › Reduced piping requirements, from 4 to 2 pipes, compared to a conventional system
- › Low sound mode available reducing sound emissions significantly without giving in on refrigeration capacity



Low Temperature Refrigeration				LCBKQ-AV1	3
Refrigerating capacity	Low temperature	Nom.	kW		3.35 (1)
Dimensions	Unit	Height	mm		480
		Width	mm		680
		Depth	mm		310
Weight	Unit		kg		47
Compressor	Type	Hermetically sealed swing compressor			
	Piston displacement		m ³ /h		10.16
	Number of revolutions		rpm		6,540
	Output		W		1,300
	Starting method	Direct on line (inverter driven)			
	Frequency ON/OFF	Less than 6 times/hour			
Fan	Type	Propeller fan			
	Air flow rate	Cooling	Nom.	m ³ /min	1.6
Operation range	Evaporator	Cooling	Min.-Max.	°CDB	-45~-20
	Ambient temperature		Min.-Max.	°C	-15~43
Refrigerant	Type	R-410A			
	GWP	2,087.5			
	Control	Electronic expansion valve			
Piping connections	For outdoor unit	Liquid	OD	mm	6.35
	To indoor unit	Liquid	OD	mm	6.35
	For indoor unit	Gas	OD	mm	15.9
	To outdoor unit	Gas	OD	mm	9.5
Power supply	Phase/Frequency/Voltage		Hz/V		1~/50/220-240

(1) Evaporating temp. -35°C; outdoor temp. 32°C; suction SH 10K; saturated temp. to discharge pressure of booster unit -10°C

Condensing unit for commercial refrigeration with reciprocating technology



JEHCCU-CM1/3

Refrigeration solution for small food retailers

- › Designed specifically for small capacity refrigeration applications in small food stores (eg. in bakeries and butchers), cold rooms, bottle coolers and display cabinets
- › Compact and lightweight for even the smallest of city centre locations
- › All components can be accessed, making maintenance quick and easy
- › Ideal for urban applications: sound proofing and low operating sound levels mean the unit is quiet
- › The optimised compressor range and increased condenser surface deliver high levels of energy efficiency and reliability is ensured by using high quality components and production processes
- › Micro channel heat exchanger technology reduces the amount of refrigerant used in the system, lowering environmental impact

Medium Temperature Refrigeration				JEHCCU-CM1/CM3	0050	0067	0100	0113	0140	
Refrigerating capacity	Medium temperature	R-404A	Nom	kW	0.910	1.225	1.495	1.761	2.220	
		R-407A	Nom	kW	0.783	1.054	1.287	1.515	1.911	
		R-407F	Nom	kW	0.882	1.187	1.449	1.706	2.151	
Power input	Medium temperature	R-404A	Nom	kW	0.626	0.763	0.927	1.102	1.235	
		R-407A	Nom	kW	0.581	0.708	0.860	1.023	1.146	
		R-407F	Nom	kW	0.611	0.744	0.904	1.075	1.204	
COP	Medium temperature	R-404A			1.45	1.61		1.60	1.80	
		R-407A			1.35	1.49	1.50	1.48	1.67	
		R-407F			1.44	1.60		1.59	1.79	
Dimensions	Unit	Height		mm	607			662		
		Width		mm	876			1,101		
		Depth		mm	420			444		
Weight	Unit			kg	45	54	55	67.5		
Compressor	Type	Reciprocating compressor								
	Model				AE4460Z-FZ1C	CAJ9480Z	CAJ9510Z	CAJ9513Z	CAJ4517Z	TAJ4517Z
	Piston displacement			m ³ /h	1.80	2.64	3.18	4.21	4.52	
	Oil Charged volume			l	0.28	0.887				
Fan	Air flow rate	Cooling	Nom	m ³ /h	1,300			2,700		
					Sound pressure level	Nom.	dB(A)	30		
Refrigerant	Type 1 / GWP	R-404A / 3,921.6								
	Type 2 / GWP	R-407A / 2,107								
	Type 3 / GWP	R-407F / 1,825								
Piping connections	Liquid line connection			inch	1/4"	3/8"				
	Suction line connection			inch	3/8"	1/2"				
Power supply	Phase/Frequency/Voltage			Hz/V	1~/50/230			3~/50/400		

Medium Temperature Refrigeration				JEHCCU-CM1	0040	0051	0063	0077	0095
Refrigerating capacity	Medium temperature	R-134a	Nom	kW	0.553	0.831	0.988	1.198	1.490
Power input	Medium temperature	R-134a	Nom	kW	0.433	0.543	0.637	0.735	0.901
COP	Medium temperature	R-134a			1.28	1.53	1.55	1.63	1.65
Dimensions	Unit	Height		mm	607				
		Width		mm	876				
		Depth		mm	420				
Weight	Unit			kg	45	53		54	
Compressor	Type	Reciprocating compressor							
	Model				AE4440Y-FZ1A	CAJ4461Y	CAJ4476Y	CAJ4492Y	CAJ4511Y
	Piston displacement			m ³ /h	1.8	3.18	3.79	4.51	5.69
	Oil Charged volume			l	0.28	0.887			
Fan	Air flow rate	Cooling	Nom	m ³ /h	1,300			2,700	
					Sound pressure level	Nom.	dB(A)	30	
Operation range	Evaporator	Cooling	Min.-Max.	°CDB	-15~-15				
	Ambient temperature	Min.-Max.		°C	-20~43				
Refrigerant	Type / GWP	R-134a / 1,430							
Piping connections	Liquid line connection			inch	1/4"			3/8"	
	Suction line connection			inch	3/8"			1/2"	
Power supply	Phase/Frequency/Voltage			Hz/V	1~/50/230				

Refer to condition: Outside ambient temperature = 32°C, Evaporation temperature = -10°C and 10K superheat (medium temperature application)

Condensing unit for commercial refrigeration with scroll technology



JEHSCU-CM1/3

Refrigeration solution for small food retailers

- › Designed specifically for small capacity refrigeration applications in small food stores (eg. in bakeries and butchers), cold rooms, bottle coolers and display cabinets
- › Compact and lightweight for even the smallest of city centre locations
- › All components can be accessed, making maintenance quick and easy
- › Ideal for urban applications: sound proofing and low operating sound levels mean the unit is quiet
- › The optimised compressor range and increased condenser surface deliver high levels of energy efficiency and reliability is ensured by using high quality components and production processes
- › Micro channel heat exchanger technology reduces the amount of refrigerant used in the system, lowering environmental impact

Medium Temperature Refrigeration				JEHSCU-CM1/3		0200 CM1	0200 CM3	0250 CM1	0250 CM3	0300 CM1	0300 CM3	0350 CM3	0400 CM3	0500 CM3	0600 CM3	0680 CM3
Refrigerating capacity	Medium temperature	R-134a	Nom	kW	2.170		2.480		3.060	3.480	4.22	5.21	6.30	7.01		
		R-404A	Nom	kW	3.490		4.210		4.890	5.460	6.820	8.210	9.820	10.350		
		R-407A	Nom	kW	3.306		3.971		4.684	5.007					- *	
		R-407F	Nom	kW	3.297		3.971		4.712	4.902					- *	
Power input	Medium temperature	R-134a	Nom	kW	1.025		1.165		1.455	1.675	1.790	2.250	2.530	2.990		
		R-404A	Nom	kW	1.695		2.035		2.515	3.065	3.343	4.210	4.866	5.611		
		R-407A	Nom	kW	1.676		2.017		2.457	2.996					- *	
		R-407F	Nom	kW	1.679		2.026		2.477	3.425					- *	
COP	Medium temperature	R-134a			2.12		2.13		2.10	2.08	2.36	2.32	2.49	2.34		
		R-404A			2.06		2.07		1.94	1.78	2.04	1.95	2.02	1.84		
		R-407A					1.97		1.91	1.67				- *		
		R-407F					1.96		1.90	1.43				- *		
Dimensions	Unit	Height	mm				662							872		
		Width	mm				1,101							575		
		Depth	mm				444							1,353		
Weight	Unit		kg	69.7		71.7		73.7		119.0	123.0	125.0	126.0			
Compressor	Type Model	Scroll compressor														
			ZB15KQE -PFJ	ZB15KQE -TFD	ZB19KQE -PFJ	ZB19KQE -TFD	ZB21KQE -PFJ	ZB21KQE -TFD	ZB26KQE- TFD	ZB29KQE -TFD	ZB38KQE -TFD	ZB45KQE -TFD	ZB48KQE -TFD			
		Piston displacement	m ³ /h	5.90	6.80	8.60	9.90	11.40	14.40	17.10	18.80					
		Oil Charged volume	l	1.24	1.30	1.36	1.45	1.5	1.36	2.07	1.89	1.8				
		Oil Type		Polyester oil (Copeland Ultra 22 CC, 32 CC and 32-3MAF, Mobil EAL™ Arctic 22 CC, Uniqem Emkarate RL32CF)												
Fan	Air flow rate	Cooling	Nom	m ³ /h	2,700				40	4,300						
Sound pressure level	Nom.			dBA	33		36		40	37	35	39	37			
Refrigerant	Type 1 / GWP	R-134a / 1,430														
	Type 2 / GWP	R-404A / 3,921.6														
	Type 3 / GWP	R-407A / 2,107														
	Type 4 / GWP	R-407F / 3,921.6														
Piping connections	Liquid line connection			inch	3/8"					1/2"						
	Suction line connection			inch	3/4"					7/8"		1-1/8"				
Power supply	Phase/Frequency/Voltage			Hz/V	1~/50 /230	3~/50 /400	1~/50 /230	3~/50 /400	1~/50 /230	3~/50/400						

* Specifications not available at time of printing

Condensing unit for commercial refrigeration

Main benefits

- › Low operation sound level
- › Easy to install - fully equipped - packaged
- › Energy efficiency and performance
- › Robust and reliable design

Installer benefits

- › Small, compact and robust for easy handling and installation in limited space
- › Fully factory tested and pre-wired electrical box for quick and easy installation and commissioning
- › Easy service thanks to very accessible components behind removable robust panels

End-user benefits

- › Very quiet operation
- › Strong anti-corrosion housing for long life, even in harsh environmental conditions
- › Trustworthy units, with proven component reliability and fully qualified for the most demanding applications
- › Reduced energy consumption, thanks to efficient compressors and condenser fan speed control (except series 1)
- › Fully packaged unit at a competitive price



Series	Model	Performance					Compressor			Oil type	Electrical Data					Receiver	Connection			Dimensions			Weight (kg)	Sound pressure dB(A) at 1m*			
		Cooling capacity (W) † R-404A	Cooling capacity (W) † R-134a	Cooling capacity (W) † R-407A	Cooling capacity (W) † R-407C	Cooling capacity (W) † R-407F	Type	Swept volume (m³/h)	Oil Charge (Liter)		Oil Charge (l)	Power input	Lock Rotor current (A)	MFA† (A)					Volume (Liter)	Suction (inch)	Liquid (inch)	Width (mm)			Depth (mm)	Height (mm)	
														R-404A	R-134a		R-407A	R-407C									R-407F
Medium temperature	JEHCCU0825M3	11,010	7,083	10,459	9,867	11,445	MTZ100-4VM	29.80	3.90	-	400V/3~50Hz	90.0	25	25	25	25	25	6770	14.0	1 1/8	1/2	1261	594	1435	205	62	
	JEHCCU1000M3	13,528	8,667	12,851	13,038	14,126	MTZ125-4VM	37.49	3.90	-	400V/3~50Hz	105.0	30	25	30	30	30	6770	14.0	1 1/8	1/2	1261	594	1435	205	62	
Low temperature	JEHCCU0075L1	418	-	-	-	-	SC18CLX	3.08	0.60	-	Oil A ‡	230V/1~50Hz	20.0	15	-	15	-	15	1910	1.2	3/8	1/4	884	430	489	46	50
	JEHCCU0175L1	947	-	-	-	-	NTZ48-5VM	8.40	0.95	0.50		230V/1~50Hz	37.0	15	-	15	-	15	3040	4.6	5/8	3/8	1104	478	650	86	55
	JEHCCU0175L3	947	-	-	-	-	NTZ48-4VM	8.40	0.95	0.50		400V/3~50Hz	16.0	15	-	15	-	15	3040	4.6	5/8	3/8	1104	478	650	86	55
	JEHCCU0225L1	1,567	-	-	-	-	NTZ68-5VM	11.80	0.95	0.50		230V/1~50Hz	53.0	20	-	20	-	20	2620	4.6	5/8	3/8	1104	478	650	92	58
	JEHCCU0225L3	1,567	-	-	-	-	NTZ68-4VM	11.80	0.95	0.50		400V/3~50Hz	25.0	15	-	15	-	15	2620	4.6	5/8	3/8	1104	478	650	92	58
	JEHCCU0350L3	1,845	-	-	-	-	NTZ96-4VM	16.70	1.80	0.60		400V/3~50Hz	32.0	15	-	15	-	15	6050	7.6	7/8	1/2	1347	556	884	125	58
Low temperature	JEHCCU0400L3	2,824	-	-	-	-	NTZ136-4VM	23.60	1.80	0.60	Oil B ‡	400V/3~50Hz	51.0	15	-	15	-	15	6050	7.6	1 1/8	1/2	1347	556	884	130	58
	JEHCCU0725L3	4,245	-	-	-	-	NTZ215-4VM	37.50	3.90	0.60		400V/3~50Hz	74.0	25	-	25	-	25	6770	14.0	1 1/8	1/2	1261	594	1435	203	61
	JEHCCU0825L3	5,818	-	-	-	-	NTZ271-4VM	47.30	3.90	0.60		400V/3~50Hz	96.0	25	-	25	-	25	6770	14.0	1 1/8	1/2	1261	594	1435	203	60
	JEHSCU0800M3	12,000	7,800	11,543	-	11,790	ZB58KCE-TFD	22.1	2.50	-		400V/3~50Hz	95.0	25	20	25	-	25	6770	14.0	1 1/8	1/2	1261	594	1435	201	64
Low temperature	JEHSCU1000M3	14,200	9,900	14,630	-	15,075	ZB76KCE-TFD	29.1	3.20	-		400V/3~50Hz	118.0	35	25	35	-	35	6770	14.0	1 3/8	1/2	1261	594	1435	201	64
	JEHSCU0200L3	1,260	-	-	-	1,188	ZF06K4E-TFD	5.9	1.30	0.50		400V/3~50Hz	26.0	15	-	15	-	15	2620	4.6	3/4	3/8	1108	478	650	94	47
	JEHSCU0300L3	1,645	-	1,701	-	1,615	ZF09K4E-TFD	8.0	1.50	0.50		400V/3~50Hz	40.0	15	-	15	-	15	2620	4.6	3/4	3/8	1108	478	650	96	48
	JEHSCU0400L3	2,485	-	2,090	-	2,280	ZF13K4E-TFD	11.8	1.90	0.60		400V/3~50Hz	51.5	15	-	15	-	15	6050	7.6	7/8	1/2	1347	556	884	129	55
	JEHSCU0500L3	3,000	-	2,632	-	2,774	ZF15K4E-TFD	14.5	1.90	0.60	Oil B ‡	400V/3~50Hz	64.0	15	-	15	-	15	6050	7.6	7/8	1/2	1347	556	884	130	56
	JEHSCU0600L3	3,600	-	3,145	-	3,335	ZF18K4E-TFD	17.1	1.90	0.60		400V/3~50Hz	74.0	15	-	15	-	15	6050	7.6	7/8	1/2	1347	556	884	130	61
	JEHSCU0750L3	4,320	-	-	-	-	ZF24K4E-TWD	20.9	4.10	0.60		400V/3~50Hz	99.0	20	-	20	-	20	6770	14.0	1 3/8	1/2	1261	594	1435	218	61
	JEHSCU1000L3	5,850	-	-	-	-	ZF33K4E-TWD	28.8	4.10	0.60		400V/3~50Hz	127.0	30	-	30	-	30	6770	14.0	1 3/8	1/2	1261	594	1435	218	62

* Refer to condition: Outside ambient temperature = 32°C, Evaporation temperature = -10°C (medium temperature application); -35°C (low temperature application)

† MFA = Maximum Fuse Amps

‡ Sound pressure level measured in anechoic room

§ O/S = Oil Separator

¶ Oil A = Polyester oil (Emkarate RL32H)ww

‡ Oil B = Polyester oil 160PZ

¶ Oil A = Polyester oil (Copeland Ultra 22 CC, Copeland Ultra 32 CC, Copeland Ultra 32-3MAF, Mobil EAL™ Arctic 22 CC, Uniqema Emkarate RL32CF)

¶ Oil B = Mobil Arctic 22CC

Note: condensing units are pre-charged with oil as stated in table

R-134a GWP = 1,430, R-407C GWP = 1,773.85, R-407A GWP = 2,107, R-407F GWP = 1,825, R-404A GWP = 3,921.6

GWP : R-134a (1430), R-404A (3921.6), R-407A (2107), R-407C (1773.85), R-407F (1825)

Condensing unit for industrial refrigeration

Designed for outdoor use, the large condensing units are a perfect medium to high capacity refrigeration solution for cold stores, distribution platforms, supermarkets, food processing, etc in low and medium temperature applications.

These industrial condensing units are real workhorses designed for maximum performance in minimum space.

- › High energy efficiency: inverter controlled compressor, economizer, high performance condenser
- › Possibility of having a stand-by compressor
- › Easy installation, ready to connect evaporators
- › Integrated starter and control panel with electronic controller
- › Space saving construction due to the compact design of the condenser coils arranged in a 'W' configuration
- › Low sound operation
- › Approved according to EN 378: 2008 (Safety and environmental requirements)
- › Refrigerants: R-404A, R-134a, R-407C, R-507A



A comprehensive product range with 1 or 2 compressors and 4, 6, 8 or 10 condenser fans

- › Chilled application:
 - R-404A | 113 - 417 kW
 - R-134a | 72.5 kW - 315.4 kW
 - R-407C | 100.3 kW - 430.2 kW (at T₀ = -10°C / T_{amb} = +32°C)
- › Frozen application:
 - R-404A | 37 - 159 kW (at T₀ = -35°C / T_{amb} = +32°C)

* R-134a GWP = 1,430, R-407C GWP=1,773.85, R-507A GWP=3,985, R-404A GWP=3,921.6

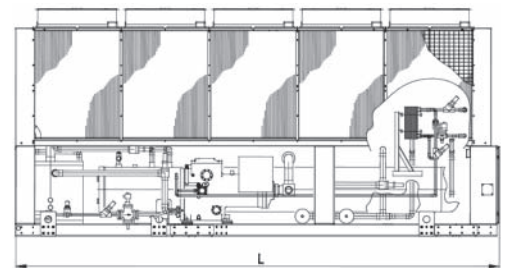
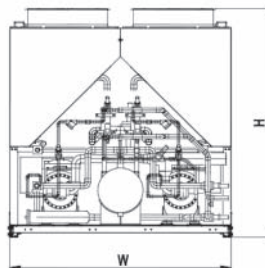
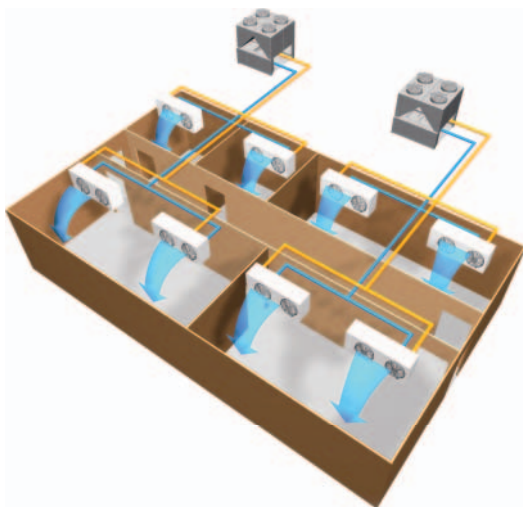

	Length mm	Width mm	Height mm	Weight kg
From	2,240	2,235	2,340	2,405
To	4,940	2,235	2,340	4,496

Options - Refrigeration

	Conveni-Pack	ZEAS						Multi-ZEAS			
	LRYEQ16AY1	LREQ5BY1	LREQ6BY1	LREQ8BY1	LREQ10BY1	LREQ12BY1	LREQ15BY1	LREQ20BY1	LREQ15BY1Rx2	LREQ20BY1Rx2	
Digital pressure gauge kit	BHGP26A1	BHGP26A1									
Pressure gauge kit	-	KHGP26B140									
Kit (Inlet + Outlet)	KPS26C504	KPS26C160	KPS26C280				KPS26C504				
	KPS26C504T	KPS26C160T	KPS26C280T				KPS26C504T				
Snowbreak hood	Left side air inlet	KPS26C504L									
	Right side air inlet	KPS26C504R									
	Back side air inlet	KPS26C504B	KPS26C160B	KPS26C280B				KPS26C504B			
Central drain pan kit	KWC26C450*	KWC26C160	KPS26C280				KPS26C450		KPS26C450** x2		
Communication box	BRR9A1V1								BRR9A1V1***		
Booster unit	LCBKQ3AV19									-	
Suction branch pipe for multi	-	-									EKHRQZM****

* In cold areas avoid the use of a drain pan in order to avoid drain water freeze up. ** required for each module
 *** software update required (to be executed during commissioning) **** mandatory



Market leading controls for 2016

- ✓ Intuitive & user-friendly interface
- ✓ Cross pillar integration
- ✓ Cloud control
- ✓ Smart energy management
- ✓ Integration of Daikin and third party products



Intelligent touch Manager

Mini BMS for medium to large commercial buildings

- › Price competitive mini BMS
- › Cross-pillar integration of Daikin products
- › Integration of third party equipment via WAGO or BACnet
- › Connect up to 2,560 indoor units groups

→ more information on page „Functions overview“ op pagina 485



Advanced centralised controller with Cloud connection

- › Simply control your entire building centrally
- › Total solution concept (integration of Split, Sky Air, VRV, ventilation, air curtains and hot water)
- › Stylish optional screen fits any interior
- › Cloud connection offers additional services such as online control, energy monitoring, comparison of energy consumption of multiple sites
- › Connect up to 32 indoor units groups

→ more information on page „Advanced centralised controller with Cloud connection“ op pagina 482

Control Systems

Control Systems

Individual control systems	475
Wired / infrared remote controls	476
Siesta Sky Air	477
Online controller	478

Centralised control systems	480
Centralised remote control / Unified ON/OFF control / Schedule timer	480
Adapter DTA113B51	481
 Controller	481
NEW Advanced centralised controller with cloud connection	482

Mini building management system	484
 Manager	484

Standard protocol interfaces	486
Modbus interface	486
KNX Interface	490
BACnet Interface	491
LonWorks Interface	491

Daikin Configuration Software	493
EKPCCAB3	493

Remote monitoring and maintenance	494
 Net	494

Wireless room temperature sensor	496
Wired room temperature sensor	496
Other integration devices	497

Options & Accessories	498
----------------------------------	------------

Requirement tables per application

Daikin offers various control solution adapted to the requirements of even the most demanding commercial application.

- › Basic control solutions for those customers with few requirements and limited budget
- › Integrating control solutions for those customers that would like to integrate Daikin units into their existing BMS system
- › Advanced control solutions for those customers that expect Daikin to deliver a mini BMS solution, including advance energy management

NEW

Shop

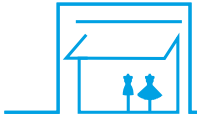

	Unit control		Integrating control			Advanced control	
	BRC1E52A/B 1 remote controller for 1 indoor unit (group)	RTD-20 1 gateway for 1 indoor unit (group)	RTD-Net 1 gateway for 1 indoor unit	KLIC-DI 1 gateway for 1 indoor unit	EKMBDXA 1 gateway for max. 64 indoor unit(s) (groups) & 10 outdoors	DCC601A51 1 unit for 32 indoor unit(s) (groups)	DCM601A51 1 iTM for 64 indoor unit(s) (groups) (1)
Automatic control of A/C	●	●	●	●	●	●	●
Limited control possibilities for shop staff	●	●	●	●	●	●	●
Create zones within the shop		●				●	●
Interlock with eg. Alarm, PIR sensor		●				●	●
Integrate Daikin units into existing BMS via Modbus			●		●		
Integrate Daikin units into existing BMS via KNX				●			
Integrate Daikin units into existing BMS via HTTP						●	
Monitor energy consumption						● (2)	●
Advanced energy management						● (2)	●
Allows free cooling						●	●
Integrate Daikin products cross pillars into Daikin BMS							●
Integrate third party products into Daikin BMS						●	●
Online control						● (2)	●
Manage multiple sites						● (2)	

(1) : 7 iTM plus adapters (DCM601A52) can be added to have 512 indoor groups and 80 outdoor (systems) (2) Via cloud control

Hotel



	Unit control	Integrating control		Advanced control	
	BRC2/3E52C 1 remote controller for 1 indoor unit (group)	RTD-Net 1 gateway for 1 indoor unit (group)	KLIC-DI 1 gateway for 1 indoor unit	DCS601C51 1 iTC for 64 indoor unit(s) (groups)	DCM601A51 1 iTM for 64 indoor unit(s) (groups) (1)
Hotel guest can control & monitor basic functionalities from his room	●	●	●	●	●
Limited control possibilities for hotel guests	●	●	●	●	●
Interlock with window contact	● (2)				●
Interlock with key-card	● (2)				●
Integrate Daikin units into existing BMS via Modbus		●			
Integrate Daikin units into existing BMS via KNX			●		
Integrate Daikin units into existing BMS via HTTP				●	
Monitor energy consumption					●
Advanced energy management					●
Integrate Daikin products cross pillars into Daikin BMS					●
Integrate third party products into Daikin BMS					●
Online control					●

(1) : 7 iTM plus adapters (DCM601A52) can be added to have 512 indoor groups and 80 outdoor (systems) (2) Via BRP7A51 adapter

Office



	Unit control	Integrating control			Advanced control		
	BRC1E52A/B	EKMBDXA	DMS504B51	DMS502A51 / DAM412B51	DCS302C51 / DST301B51	DCS601C51	DCM601A51
	1 remote controller for 1 indoor unit (group)	1 gateway for max. 64 indoor unit(s) (groups) & 10 outdoors	1 gateway for 64 indoor unit(s) (groups)	1 gateway for 128 indoor unit(s) (groups), 20 outdoors (2)	1 R/C for max. 64 groups, 128 indoor units, 10 outdoors	1 iTC for 64 indoor unit(s) (groups)	1 iTM for 64 indoor unit(s) (groups) (1)
Automatic control of A/C	●	●	●	●	● (3)	●	●
Centralised control for management		●	●	●	●	●	●
Local control for office workers	●	●	●	●	●	●	●
Limited control possibilities for office workers	●					●	●
Integrate Daikin units into existing BMS via Modbus		●					
Integrate Daikin units into existing BMS via KNX							
Integrate Daikin units into existing BMS via HTTP						●	
Integrate Daikin units into existing BMS via LonTalk			●				
Integrate Daikin units into existing BMS via BACnet				●			
Energy consumption read out	●						
Monitor energy consumption							●
Advanced energy management							●
Integrate Daikin products cross pillars into Daikin BMS							●
Integrate third party products into Daikin BMS							●
Online control							●

(1) : 7 iTM plus adapters (DCM601A52) can be added to have 512 indoor groups and 80 outdoor (systems)

(2) : extension needed to go to 256 indoor unit(s) (groups), 40 outdoors

(3) : ON/OFF only

NEW

launch Spring
2016

Infrastructure cooling



	Unit	Integrating	Advanced
		BRC1E53A/B/C	RTD-10
	1 remote controller for 1 indoor unit (group) (2)	1 gateway for up to 8 indoor units (group)	1 iTM for 64 indoor unit(s) (groups) (1)
Automatic control of A/C	●	●	●
Back-up operation	●	●	●
Duty rotation	●	●	●
Limited control possibilities in the technical cooling room	●	●	●
If room temperature above max., then show alarm & start standby unit.	●	●	●
If an error occurs, an alarm will be shown.	●	●	●

(1) : 7 iTM plus adapters (DCM601A52) can be added to have 512 indoor groups and 80 outdoor (systems) (2) Infrastructure cooling functions only compatible with indoor units connected to Seasonal Smart outdoor units.

Controllers

ONLINE
CONTROLLER



WIRED REMOTE CONTROL
BRC1E52A/B



INTELLIGENT
TOUCH MANAGER
DCM601A51



INFRARED REMOTE CONTROL



BRC1E52A/B

User friendly remote control with contemporary design

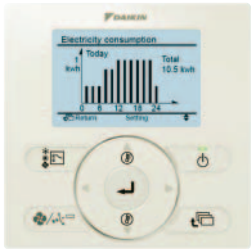

Graphical display of indicative electricity consumption (Function available in combination with FBQ-D, FCQG and FCGHQ)

A series of energy saving functions that can be individually selected

- › Temperature range limit
- › Setback function
- › Presence & floor sensor connection (available on round flow and fully flat cassette)
- › kWh indication
- › Set temperature auto reset
- › Off timer

Temperature range limit avoids excessive heating or cooling

Save energy by constraining the lower temperature limit in cooling and upper temperature limit in heating mode.

note : Also available in auto cooling/heating change over mode.

kWh indication keeps track of your consumption

The kWh indication shows an indicative electricity consumption of the last day/month/year.

Other functions

- › Up to 3 independent schedules can be set, so the user can easily change the schedule himself throughout the year (e.g. Summer, winter, mid-season)
- › Possibility to individually restrict menu functions
Easy to use: all main functions directly accessible
- › Easy setup: clear graphical user interface for advanced menu settings
- › Real time clock with auto update to daylight saving time
- › Built-in backup power: when a power failure occurs all settings remain stored up to 48 hours
- › Supports multiple languages:
English, German, Dutch, Spanish, Italian, Portuguese, French, Greek, Russian, Turkish, Polish (BRC1E52A)
English, German, Czech, Croatian, Hungarian, Romanian, Slovenian, Bulgarian, Slovak, Serbian and Albanian (BRC1E52B)

BRC2E52A / BRC3E52A

Simplified wired remote control developed for hotel applications



BRC2E52A

Heat recovery type



BRC3E52A

Heat pump type

- › Symbol driven interface for intuitive control
- › Functions restricted to basic customer needs
- › Contemporary design
- › Energy saving thanks key card, window contact integration and set point limitation (BRP7A51)
- › Flexible setback function ensures room temperature remains within comfortable limits to ensure guest comfort

- › Flat backpanel for easy installation
- › Easy commissioning: intuitive interface for advanced menu settings
- › 2 versions available:
 - Heat pump type: temperature, fan speed, ON/OFF
 - Heat recovery type: temperature, mode, fan speed, ON/OFF
- › Replaces existing BRC2C51 & BRC3A61

Key card and window contact integration

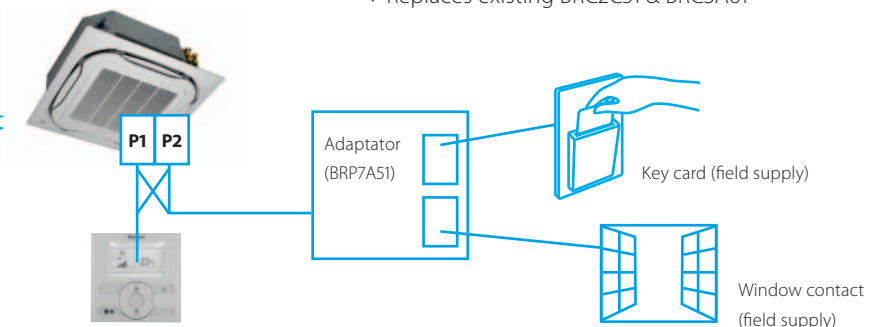

Individual control systems



BRC073

Wired remote control for residential use



BRC073

- › User friendly remote control with contemporary design
- › Easy to use: all main functions directly accessible
- › Easy commissioning: intuitive interface for advanced menu settings
- › Optimise your air conditioning system by activating a series of energy saving functions (temperature range limit, setback function, off timer, ...)
- › Set up to 3 independent schedules, so the user can easily change the schedule himself throughout the year (e.g. summer, winter, mid-season)
- › Real time clock with auto update to daylight saving time
- › Supports multiple languages (English, German, French, Italian, Spanish, Portuguese, Dutch, Czech, Croatian, Hungarian, Slovenian, Romanian, Bulgarian, Russian, Greek, Turkish, Polish, Serbian and Slovak) (depending on language package)
- › Possibility to individually restrict menu functions
- › Possibility to individually restrict each button
- › Possibility to individually restrict each operation mode (Cooling, Heating, Auto, etc.)
- › When a power failure occurs all settings remain stored up to 48 hours thanks to the built-in backup power
- › Setback operation maintains the indoor temperature at your specified comfort level during absence, thus saving energy

Note : Cable for wired remote control BRCW901A03 (3m) or BRCW901A08 (8m) required

BRC1D52

Wired remote control



BRC1D52

- › Schedule timer:
 - Five day actions can be set as follows:
 - set point: unit is switched ON and normal operation is maintained
 - OFF: unit is switched OFF1
 - limits: unit is switched ON and min./max. control (cf. limit operation for more details)
- › Home leave (frost protection): during absence, the indoor temperature can be maintained at a certain level. This function can also switch the unit ON/OFF
- › User friendly HRV function, thanks to the introduction of a button for ventilation mode and fan speed
- › Constantly monitoring of the system for malfunctions in a total of 80 components
- › Immediate display of fault location and condition
- › Reduction of maintenance time and costs

Display

- › Operating mode
- › Heat Recovery Ventilation (HRV) in operation
- › Cool / heat changeover control
- › Centralised control indication
- › Group control indication
- › Set temperature
- › Air flow direction
- › Programmed time
- › Inspection test / operation
- › Fan speed
- › Clean air filter
- › Defrost / hot start
- › Malfunction

ARC4*/BRC4*/BRC7*

Infrared remote control



ARC466A1

BRC4*/BRC7*

Operation buttons: ON/OFF, timer mode start/stop, timer mode on / off, programme time, temperature setting, air flow direction (1), operating mode, fan speed control, filter sign reset (2), inspection (2)/test indication (2)

Display: Operating mode, battery change, set temperature, air flow direction (1), programmed time, fan speed, inspection / test operation (2)

1. Not applicable for FXDQ, FXSQ, FXNQ, FBDQ, FDXS, FBQ
2. For FX** units only
3. For all features of the remote control, refer to the operation manual

ARCWLA / ARCWB

Siesta individual control systems

Overview controllers for Siesta Sky Air

Siesta Sky Air indoor units	Controllers
ACQ-D 4-way blow, ceiling mounted cassette	<ul style="list-style-type: none"> Standard infrared remote control (ARCWLA) in box of decoration panel ADP125A Wired remote control ARCWB Optional group controller R04084124324
AHQ-C ceiling suspended	<ul style="list-style-type: none"> Standard infrared remote control in box of indoor unit ARCWLA Wired remote control ARCWB Optional group controller R04084124324
ABQ-C concealed ceiling	<ul style="list-style-type: none"> Standard wired remote control (ARCWB) in box of indoor unit Optional group controller R04084124324

Overview of features



ARCWB

Feature		ARCWB
		AHQ-C and ACQ-D / Standard for ABQ-C
1	ON/OFF switch	-
2	Temperature setting	Default range 16-30°C
		Optional range 20-30°C
		Switch between °C and °F
3	Room temperature sensor on remote control	-
4	Cool / Fan dry / Heat / Auto	-
5	Sleep mode	-
6	Fan Speed selection	-
7	Delay timer	••
8	7-days programmable timer	-
9	Real time clock display	-
10	Air swing selection	ON/OFF swing mode
		Change swing option (draft/soil prevention or standard)
11	LCD display without backlight	-
12	Key lock	-
13	Error code indication	-
14	IR receiver to enable compatibility with infrared remote control (disabled when lock function is activated)	-
15	Last state memory from indoor PCB	-
16	Silent mode	•
17	Turbo mode	•
18	Compressor test model (compressor force ON)	-
19	Daikin inverter error code	-
20	UART communication port (for Daikin protocol)	-
21	Backup battery	-

Specifications

- › Dimensions (length x width x height) ARCWB: 0.15 m x 0.21 m x 0.04 m.
- › ARCWB comes standard with a 10 metre cable, which can be extended to maximum cable length of 15 metres. ARCWB can only control one indoor unit at a time; group control is only possible when using option R04084124324.

- Standard
- By dipswitch selection
- 1, 2 & 4 hours delay

Online controller

BRP069A41/42/43/45

Always in control, no matter where you are



The plug-and-play Online Controller allows you to set and even schedule the temperature from anywhere using Apple or Android systems. So you can manage the unit when away from home, offering optimal climate control while saving energy.

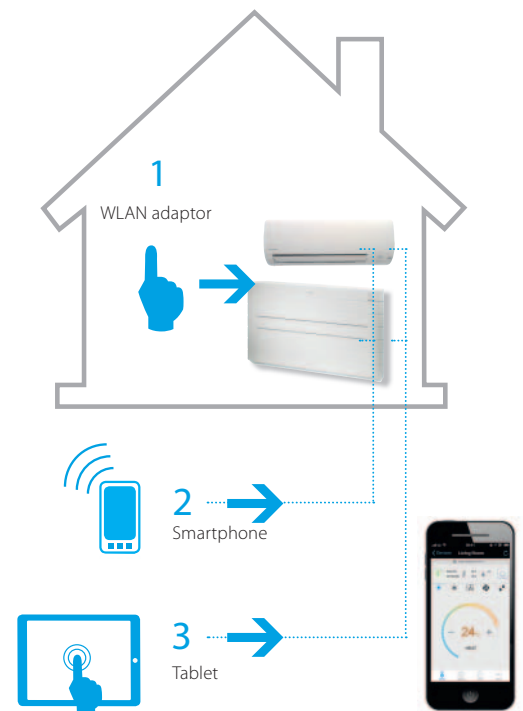

With the Daikin Online Controller application in combination with the plug-and-play wireless LAN device and an active internet connection, you can manage your unit from anywhere, offering optimal climate control while saving energy.

The Daikin Online Controller application can control and monitor the status of up to 50 units and allows you to:

- › Monitor the status of your heat pump unit
- › Control the operation mode, set temperature, air flow rate and direction
- › Schedule the set temperature and operation mode with up to 4 actions per day for 7 days

Connectable indoor units

BRP069A41	BRP069A42	BRP069A43	BRP069A45
<ul style="list-style-type: none"> › FTXG-LW/S › FTXJ-MW/S * 	<ul style="list-style-type: none"> › FTXZ-N › FTXS35-42-50K › FTXS60-71G › FTXM35-42-50K › FTX50-60-71GV › FTXLS-K3 › FVXG-K › FVXS-F › FLXS-B(9) › ATXS35-50K 	<ul style="list-style-type: none"> › CTXS15-35K › FTXS20-25K › FTXM20-25K › FTX20-25-35J3 › FTXL-JV › ATXS20-25K › ATX-J3 › ATXL-JV 	<ul style="list-style-type: none"> › FTX20-25-35KV › FTX50-60KV › ATX-KV

* controller included with the unit

Features Online Controller

The Daikin online controller can manage your unit in several ways.

You can operate it in-home by connecting your smartphone to a private wireless network or out-of-home by connecting your smartphone to a mobile network (e.g. 3G) or an external wireless network.

Feature	In-home operation	Out-of-home operation
Start/stop operation	•	•
Set operation mode: - Automatic - Cooling - Heating - Fan only - Dry	•	•
Set temperature point	•	•
Set weekly schedule timer Available actions: Start/stop operation, select operation mode, set temperature set point. Maximum 4 actions per day (28 actions total).	•	•
Set air flow rate	•	•
Set air flow direction	•	•
Readout current room temperature	•	•
Readout current outdoor temperature	•	•
Readout current humidity		
Readout smartphone application version	•	•
Readout wireless adapter firmware version	•	•
Readout error code (if any)	•	•
Set custom adapter name	•	•
Disable/enable adapter LED's	•	•
Child lock function	•	
Connection test function	•	
Remote adapter software updates	•	
Automatic daylight saving time function	•	•
Demo function (internet connection required)		•

Centralised control systems

Centralised control of the Sky Air and VRV system can be achieved via 3 user friendly compact remote controllers. These controls may be used independently or in combination with 1 group = several (up to 16) indoor units in combination and 1 zone = several groups in combination.

A centralised remote control is ideal for use in tenanted commercial buildings subject to random occupation, enabling indoor units to be classified in groups per tenant (zoning).

The schedule timer programmes the schedule and operation conditions for each tenant and the control can easily be reset according to varying requirements.

DCS302C51

Centralised remote control



Providing individual control of 64 groups (zones) of indoor units.

- › a maximum of 64 groups (128 indoor units, max. 10 outdoor units) can be controlled
- › a maximum of 128 groups (128 indoor units, max. 10 outdoor units) can be controlled via 2 centralised remote controls in separate locations
- › zone control
- › group control
- › malfunction code display
- › maximum wiring length of 1,000m (total: 2,000m)
- › air flow direction and air flow rate of HRV can be controlled
- › expanded timer function

DST301B51

Schedule timer



Enabling 64 groups to be programmed.

- › a maximum of 128 indoor units can be controlled
- › 8 types of weekly schedule
- › a maximum of 48 hours back up power supply
- › a maximum wiring length of 1,000m (total: 2,000m)

DCS301B51

Unified ON/OFF control



Providing simultaneous and individual control of 16 groups of indoor units.

- › a maximum of 16 groups (128 indoor units) can be controlled
- › 2 remote controls in separate locations can be used
- › operating status indication (normal operation, alarm)
- › centralised control indication
- › maximum wiring length of 1,000m (total: 2,000m)

DTA113B51

Basic solution for control of Sky Air and VRV

- › Rotation function
- › Backup operation function.

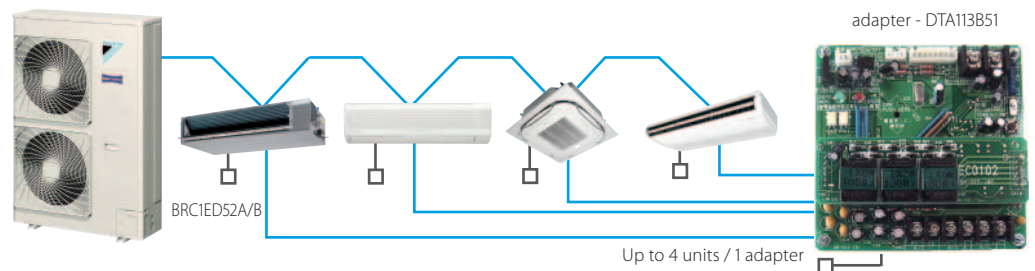

Intelligent Controller

DCS601C51

Detailed & easy monitoring and operation of VRV systems (max. 64 indoor units groups).

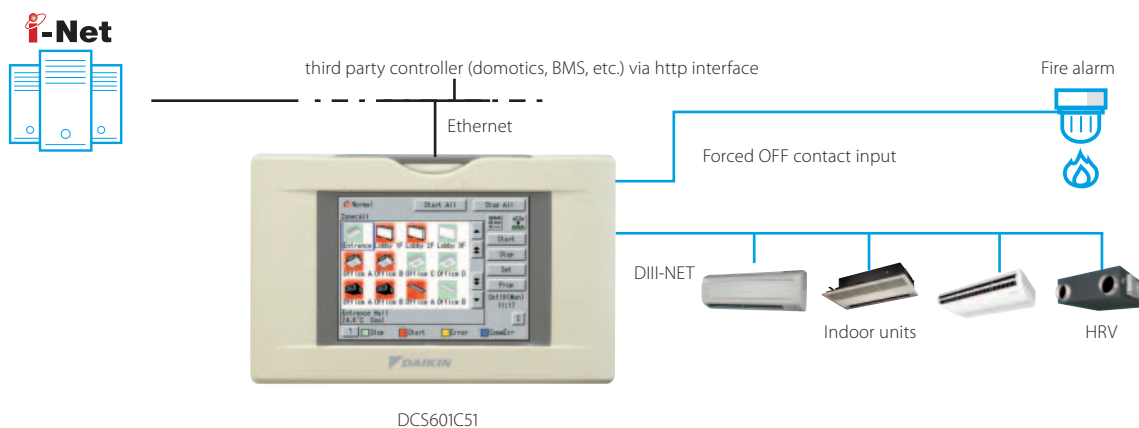

Languages

- › English
- › French
- › German
- › Italian
- › Spanish
- › Dutch
- › Portuguese

System layout

- › Up to 64 indoor units can be controlled
- › Touch panel (full colour LCD via icon display)

Control

- › Individual control (set point, start/stop, fan speed) (max. 64 groups/indoor units)
- › Set back shedule
- › Enhanced scheduling function (8 schedules, 17 patterns)
- › Flexible grouping in zones
- › Yearly schedule
- › Fire emergency stop control
- › Interlocking control
- › Increased HRV monitoring and control function
- › Automatic cooling / heating change-over
- › Heating optimization
- › Temperature limit
- › Password security: 3 levels (general, administration & service)
- › Quick selection and full control
- › Simple navigation

Monitoring

- › Visualisation via Graphical User Interface (GUI)
- › Icon colour display change function
- › Indoor units operation mode
- › Indication filter replacement
- › Multi PC

Cost performance

- › Free cooling function
- › Labour saving
- › Easy installation
- › Compact design: limited installation space
- › Overall energy saving

Open interface

- › Communication to any third party controller (domotics, BMS, etc.) is possible via open interface (http option DCS007A51)

Connectable to

- › VRV
- › HRV
- › Sky Air
- › Split (via interface adapter)

DCC601A51

Advanced centralised controller with Cloud connection

- Intuitive and user-friendly interface
- Flexible concept for stand alone and multi site applications
- Total solution thanks to integration of 3rd party equipment
- Monitor & control your small commercial building, no matter where you are

2 solutions:

Local solution

- › Offline centralized control via stylish optional screen
- › Stylish interface fits any interior

Cloud solution

- › Flexible online control from any device (Laptop, tablet...)
- › Monitor & control one or multiple sites
- › Benchmark the energy consumption of different installations
- › Energy consumption follow-up to comply with local regulations

System layout

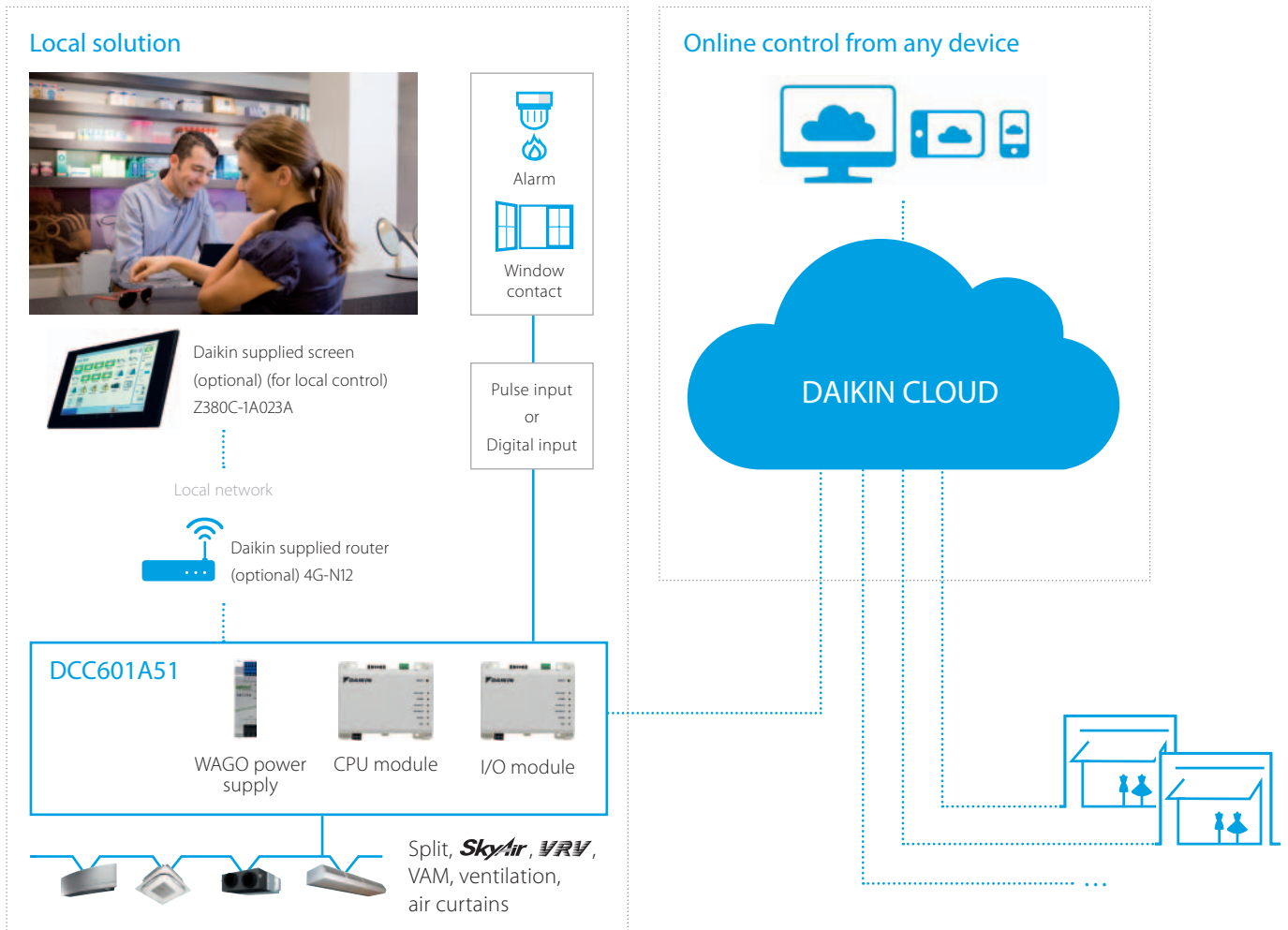

Total solution

- › Total solution thanks to a large integration of Daikin products and 3rd party equipment
- › Connect a wide range of Daikin units (Split, Sky Air, VRV, Ventilation, air curtains)
- › Simply control your entire building centrally
- › Increased customer shopping experience by better management of your shop comfort level

Daikin Cloud services

- › Control your building no matter where you are
- › Monitor and control multiple sites
- › Installer or technical manager can remotely login to the site in case of malfunctions for first trouble shooting
- › Benchmark the energy consumption of different installations
- › Manage & track your energy use
- › Monitor the long time operation units to keep the consumption under control

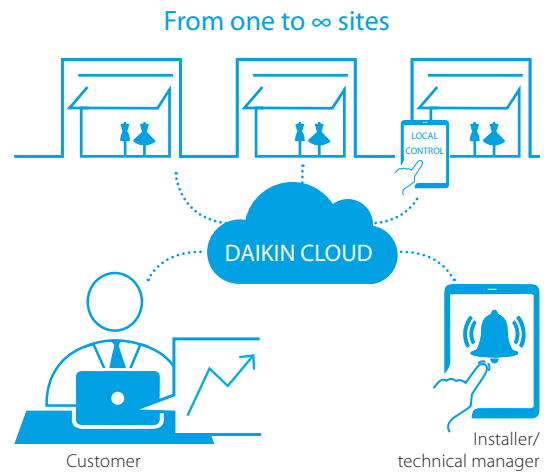

User friendly touch control

- › Stylish Daikin supplied optional screen for local control fits any interior
- › Intuitive and user-friendly interface
- › Full solution with simple control
- › Easy commissioning



Flexible

- › Inputs via digital and pulse input for 3rd party equipment such as kwh meters, emergency input, window contact, ...
- › Modular concept allows your cloud to grow with your business
- › Control up to 32 indoor unit groups

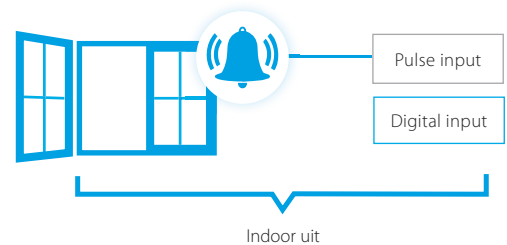

Functions overview

		Local solution	Cloud solution
Languages	EN, FR, DE, IT, ES, NL, PT	●	●
System layout	N° of connectable indoor unit groups	32	32
	Multiple sites control		●
Monitoring & control	Basic control functions (ON/OFF, mode, filter sign, setpoint, fan speed, ventilation mode, ...)	●	●
	Remote control prohibition	●	●
	All devices ON/OFF	●	●
	Group control	●	●
	Weekly schedule	●	●
	Interlock control	●	●
	Set point limitation	●	●
	Vizualiasation of energy use per operation mode		●
	Error e-mail		●
Connectable to	DX split, Sky Air, VRV	●	●
	VAM, VKM ventilation	●	●
	Air curtains	●	●



DCM601A51

Mini BMS

with full integration across all product pillars

- Price competitive mini BMS
- Cross-pillar integration of Daikin products
- Integration of third party equipment

System overview

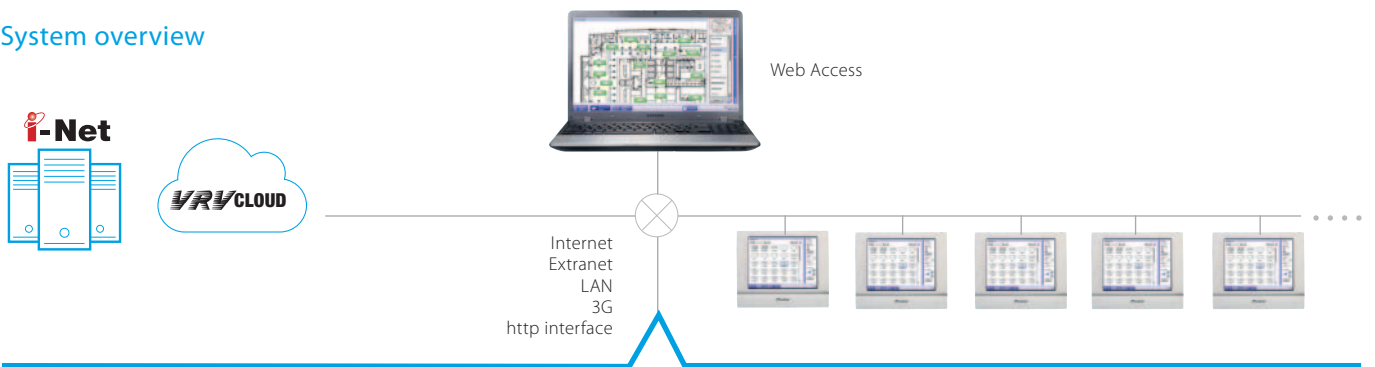

Integration of third party equipment

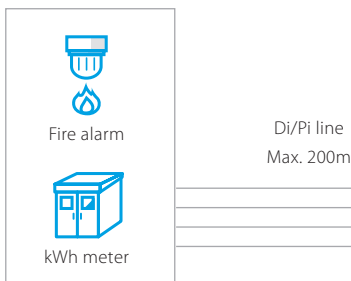

Full control of Daikin HVAC-R portfolio

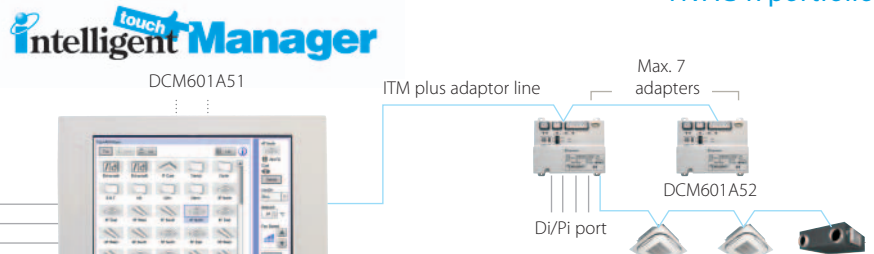

Direct plug & play connection!

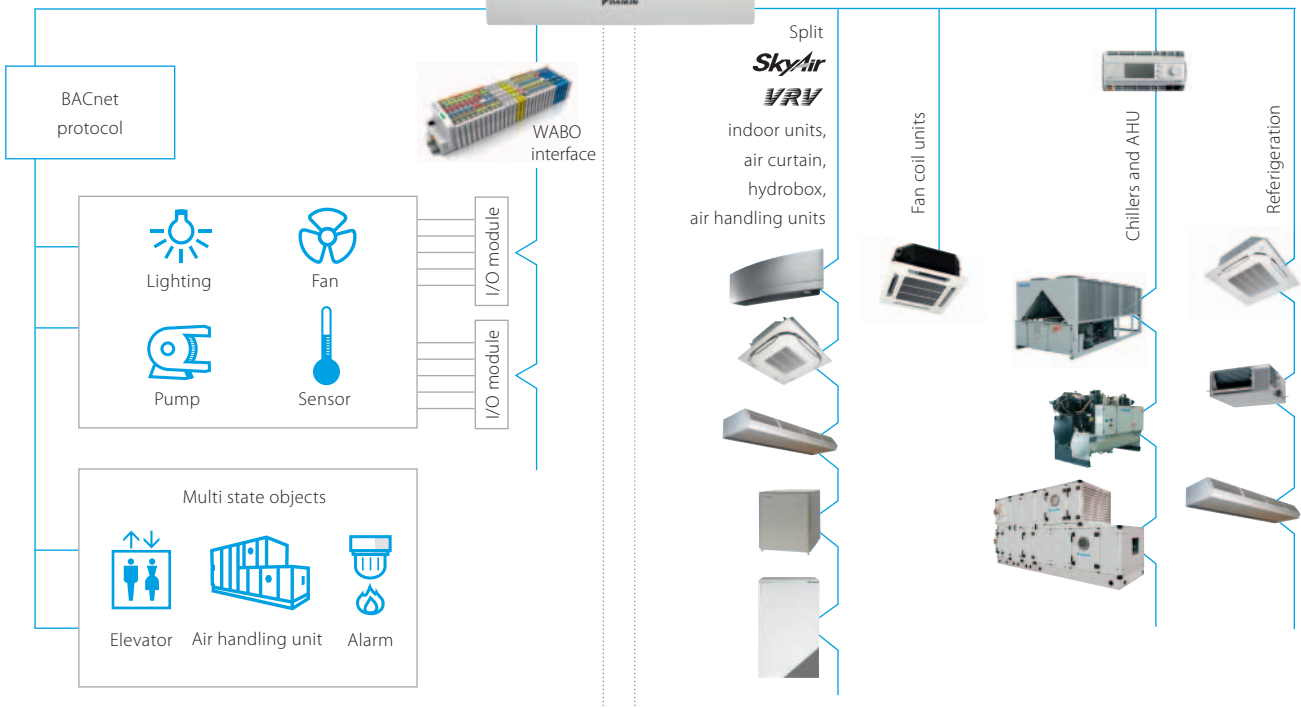



User friendliness

- › Intuitive user interface
- › Visual lay out view and direct access to indoor unit main functions
- › All functions direct accessible via touch screen or via web interface

Smart energy management

- › Monitoring if energy use is according to plan
- › Helps to detect origins of energy waste
- › Powerful schedules guarantee correct operation throughout the year
- › Save energy by interlocking A/C operation with other equipment such as heating

Flexibility

- › Cross-pillar integration (heating, air conditioning, applied systems, refrigeration, air handling units)
- › BACnet protocol for 3rd party products integration
- › I/O for integration of equipment such as lights, pumps... on WAGO modules
- › Modular concept for small to large applications
- › Control up to 2,560 indoor unit groups

Easy servicing and commissioning

- › Remote refrigerant containment check preventing on site visit
- › Simplified troubleshooting
- › Save time on commissioning thanks to the pre-commissioning tool
- › Auto registration of indoor units

Functions overview

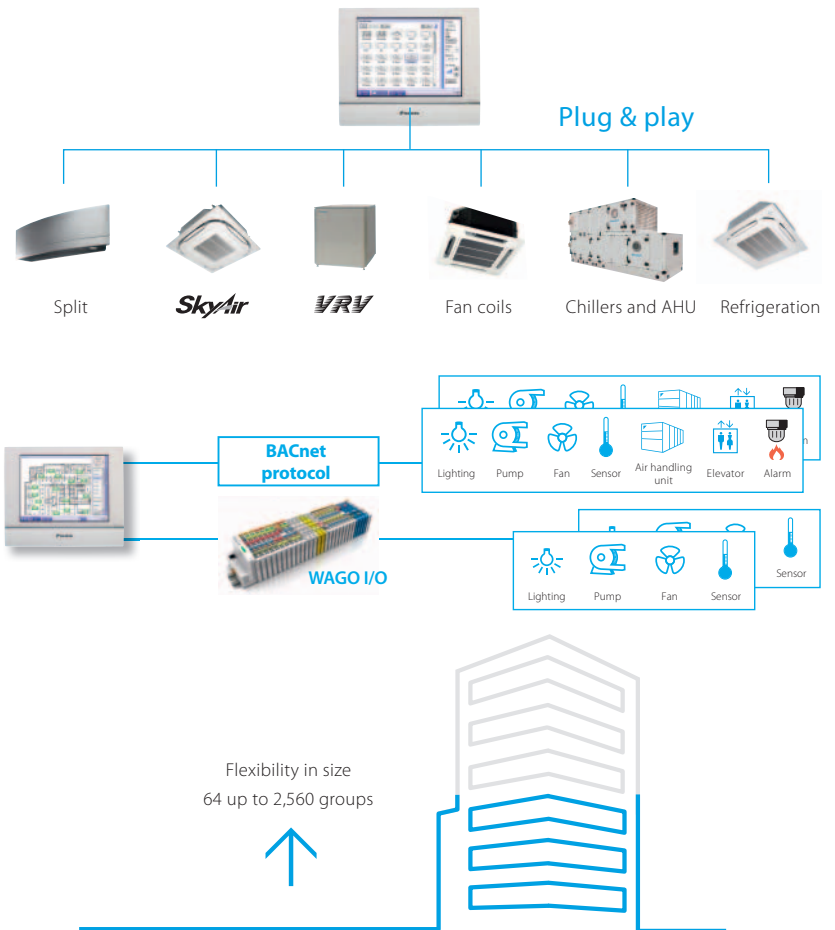
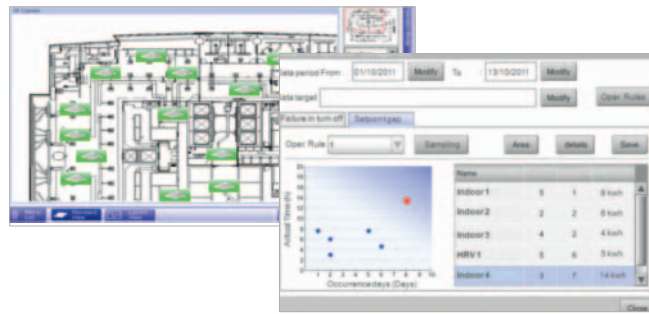

Languages

- › English
- › French
- › German
- › Italian
- › Spanish
- › Dutch
- › Portuguese

System layout

- › Up to 2,560 unit groups can be controlled (ITM plus Integrator + 7 iPU (incl. iTM adaptor)
- › Ethernet TCP/IP

Management

- › Web access
- › Power Proportional Distribution (option)
- › Operational history (malfunctions, operation hours, ...)
- › Smart energy management
 - monitor if energy use is according to plan
 - detect origins of energy waste
- › Setback function
- › Sliding temperature

Control

- › Individual control (512 groups)
- › Schedule setting (Weekly schedule, yearly calendar, seasonal schedule)
- › Interlock control
- › Setpoint limitation
- › Temperature limit

WAGO Interface

- › Modular integration of 3rd party equipment
 - WAGO coupler (interface between WAGO and Modbus)
 - Di module
 - Do module
 - Ai module
 - Ao module
 - Thermistor module
 - Pi module

Connectable to

- DX Split, Sky Air, VRV
- Chillers (via POL638.70 controller)
- Daikin AHU
- Fan coils
- Daikin Altherma Flex type
- LT and HT hydroboxes
- Air curtains
- WAGO I/O
- BACnet protocol

Modbus Interface

RTD

RTD-RA

- › Modbus interface for monitoring and control of residential indoor units

RTD-NET

- › Modbus interface for monitoring and control of Sky Air, VRV, VAM and VKM

RTD-10

- › Advanced integration into BMS of Sky Air, VRV, VAM and VKM through either:
 - Modbus
 - Voltage (0-10V)
 - Resistance
- › Duty/standby function for server rooms

RTD-20

- › Advanced control of Sky Air, VRV, VAM/VKM and air curtains
- › Clone or independent zone control
- › Increased comfort with integration of CO₂ sensor for fresh air volume control
- › Save on running costs via
 - pre/post and trade mode
 - set point limitation
 - overall shut down
 - PIR sensor for adaptive deadband

RTD-HO

- › Modbus interface for monitoring and control of Sky Air, VRV, VAM and VKM
- › Intelligent hotel room controller

RTD-W

- › Modbus interface for monitoring and control of Daikin Altherma Flex Type, VRV HT hydrobox and small inverter chiller



Overview functions



Main functions			RTD-RA	RTD-NET	RTD-10	RTD-20	RTD-HO
Dimensions	H x W x D	mm	80 x 80 x 37,5			100 x 100 x 22	
Key card + window contact							✓
Set back function			✓				
Prohibit or restrict remote control functions (setpoint limitation,...)			✓	✓	✓	✓	✓
Modbus (RS485)			✓	✓	✓	✓	✓
Group control			✓(1)	✓	✓	✓	✓
0 - 10 V control				✓	✓	✓	
Resistance control				✓	✓	✓	
IT application			✓		✓		
Heating interlock					✓		
Output signal (on/defrost, error)					✓	✓	✓
Retail application						✓	
Partitioned room control						✓	
Air curtain				✓	✓	✓	

(1): By combining RTD-RA devices

Control functions	RTD-RA	RTD-NET	RTD-10	RTD-20	RTD-HO
On/Off	M,C	M	M,V,R	M	M*
Set point	M	M	M,V,R	M	M*
Mode	M	M	M,V,R	M	M*
fan	M	M	M,V,R	M	M*
Louver	M	M	M,V,R	M	M*
HRV Damper control	M	M	M,V,R	M	M
Prohibit/Restrict functions	M	M	M,V,R	M	M*
Forced thermo off	M				

Monitoring functions	RTD-RA	RTD-NET	RTD-10	RTD-20	RTD-HO
On/Off	M	M	M	M	M
Set point	M	M	M	M	M
Mode	M	M	M	M	M
fan	M	M	M	M	M
Louver	M	M	M	M	M
RC temperature		M	M	M	M
RC mode		M	M	M	M
nbr units		M	M	M	M
Fault	M	M	M	M	M
Fault code	M	M	M	M	M
Return air temperature (Average /Min/Max)	M	M	M	M	M
Filter alarm		M	M	M	M
Thermo on	M	M	M	M	M
Defrost		M	M	M	M
Coil In/Out temperature	M	M	M	M	M



Main functions			RTD-W
Dimensions	H x W x D	mm	100x100x22
On/off prohibition			✓
Modbus RS485			✓
Dry contact control			✓
Output signal (operation error)			✓
Space heating / cooling operation			✓
Domestic hot water control			✓
Smart Grid control			

Control functions	RTD-W
On/Off Space heating/cooling	M,C
Set point leaving water temperature (heating / cooling)	M,V
Room temperature setpoint	M
Operation mode	M
Domestic Hot water ON	
Domestic Hot Water reheat	M,C
Domestic Hot Water reheat setpoint	
Domestic Hot Water storage	M
Domestic Hot Water Booster setpoint	
Quiet mode	M,C
Weather dependent setpoint enable	M
Weather dependent curve shift	M
Fault/pump info relay choice	
Control source prohibition	M

Smart grid mode control	RTD-W
Prohibit Space heating/cooling	
Prohibit DHW	
Prohibit Electric heaters	
Prohibit All operation	
PV available for storage	
Powerful boost	

Monitoring functions	RTD-W
On/Off Space heating/cooling	M,C
Set point leaving water temperature (H/C)	M
Room temperature setpoint	M
Operation mode	M
Domestic Hot Water reheat	M
Domestic Hot Water storage	M
Number of units in the group	M
Average leaving water temperature	M
Remocon room temperature	M
Fault	M,C
Fault code	M
Circulation pump operation	M
Flow rate	
Solar pump operation	
Compressor status	M
Desinfection operation	M
Setback operation	M
Defrost/ start up	M
Hot start	
Booster Heater operation	
3-Way valve status	
Pump running hours accumulated	M
Compressor running hours accumulated	
Actual leaving water temperature	M
Actual return water temperature	M
Actual DHW tank temperature (*)	M
Actual refrigerant temperature	
Actual outdoor temperature	M

M : Modbus / R : Resistance / V : Voltage / C: control
 * : only when room is occupied / ** : setpoint limitation / (*) if available
 *** : no fan speed control on the CVY air curtain / **** : run & fault

DIII-net Modbus interface

EKMBDXA

Integrated control system for seamless connection between Split, Sky Air, VRV and small inverter chillers and BMS systems



- › Communication via Modbus RS485 protocol
- › Detailed monitoring and control of the VRV total solution
- › Easy and fast installation via DIII-net protocol
- › As the Daikin DIII-net protocol is being used, only one modbus interface is needed per Daikin unit

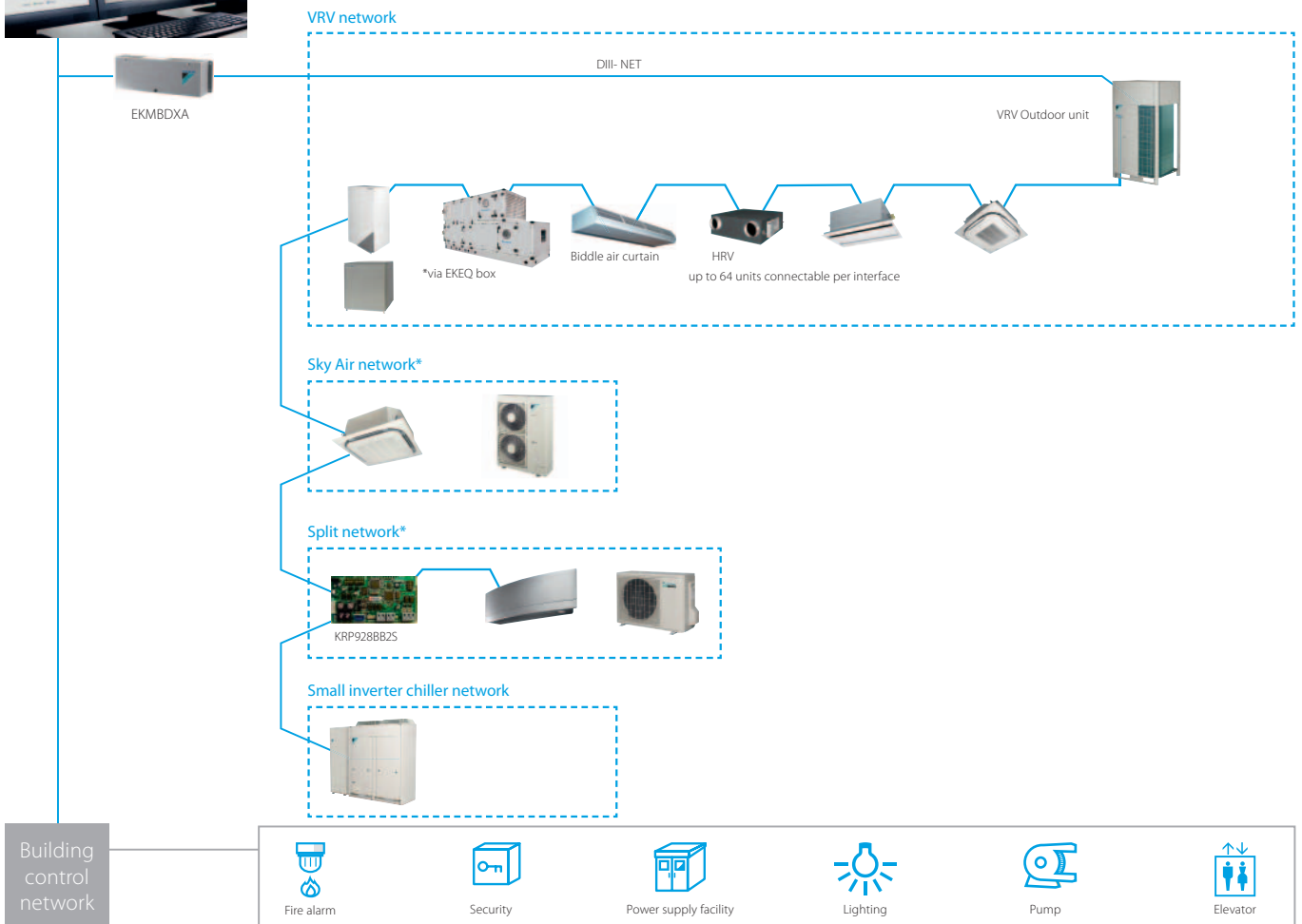
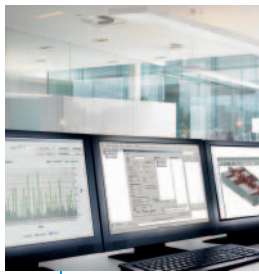

* Additional centralized controller might be required. For more information contact your local dealer.

			EKMBDXA7V1
Maximum number of connectable indoor units			64
Maximum number of connectable outdoor units			10
Communication	DIII-NET - Remark		DIII-NET (F1F2)
	Protocol - Remark		2 wire; communication speed: 9600 bps or 19200 bps
	Protocol - Type		RS485 (modbus)
	Protocol - Max. Wiring length	m	500
Dimensions	HeightxWidthxDepth	mm	124x379x87
Weight		kg	2.1
Ambient temperature - operation	Max.	°C	60
	Min.	°C	0
Installation			Indoor installation
Power supply	Frequency	Hz	50
	Voltage	V	220-240

Modbus interface

Integrate chillers, fan coil units and air handling units in BMS systems via modbus protocol

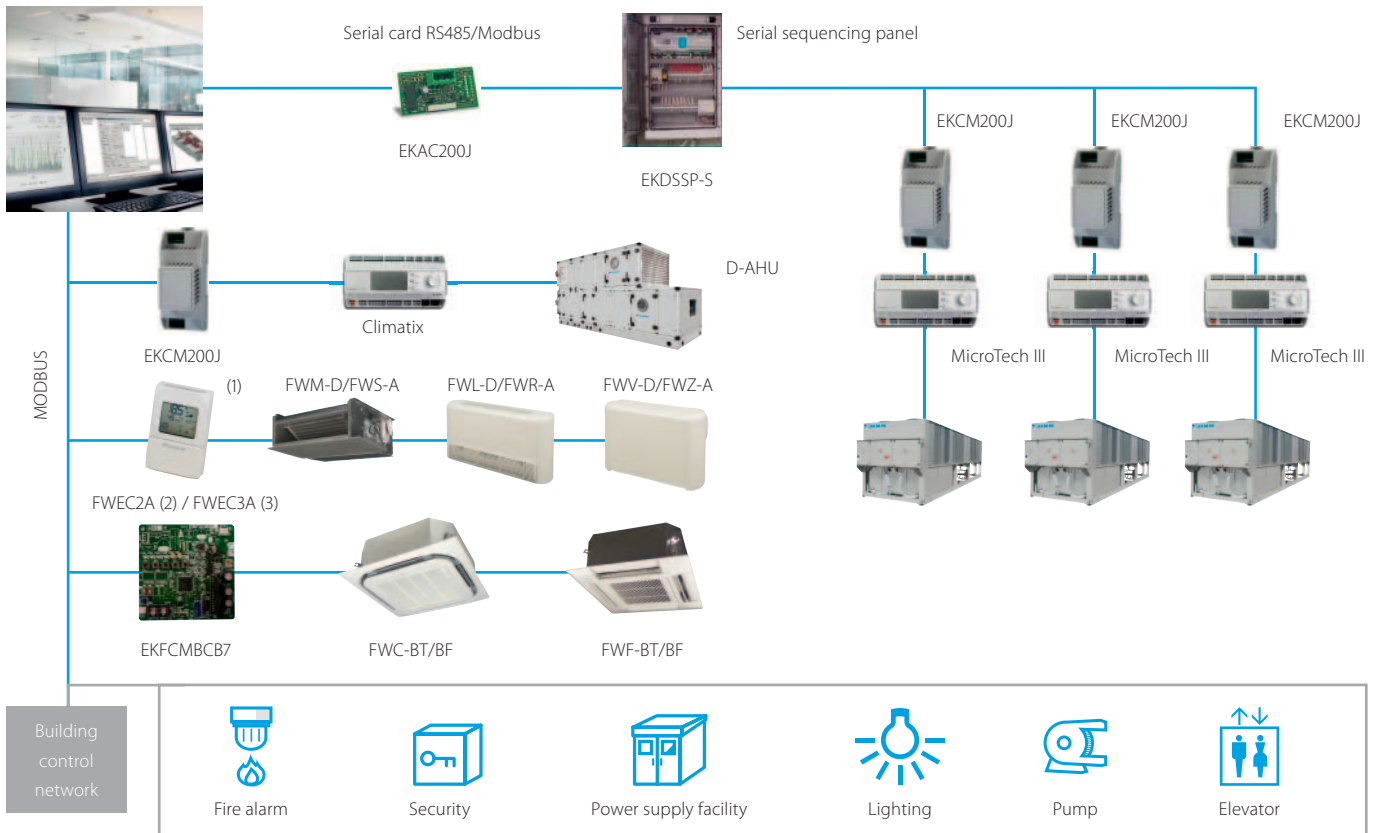

(1) The communication module is integrated in the controller (2) Connection to FWV-D, FWL-D & FWM-D (3) Connection to FWV-D, FWL-D, FWM-D and to FWZ-A, FWR-A, FWS-A

Integrate Refrigeration units in BMS systems via modbus protocol

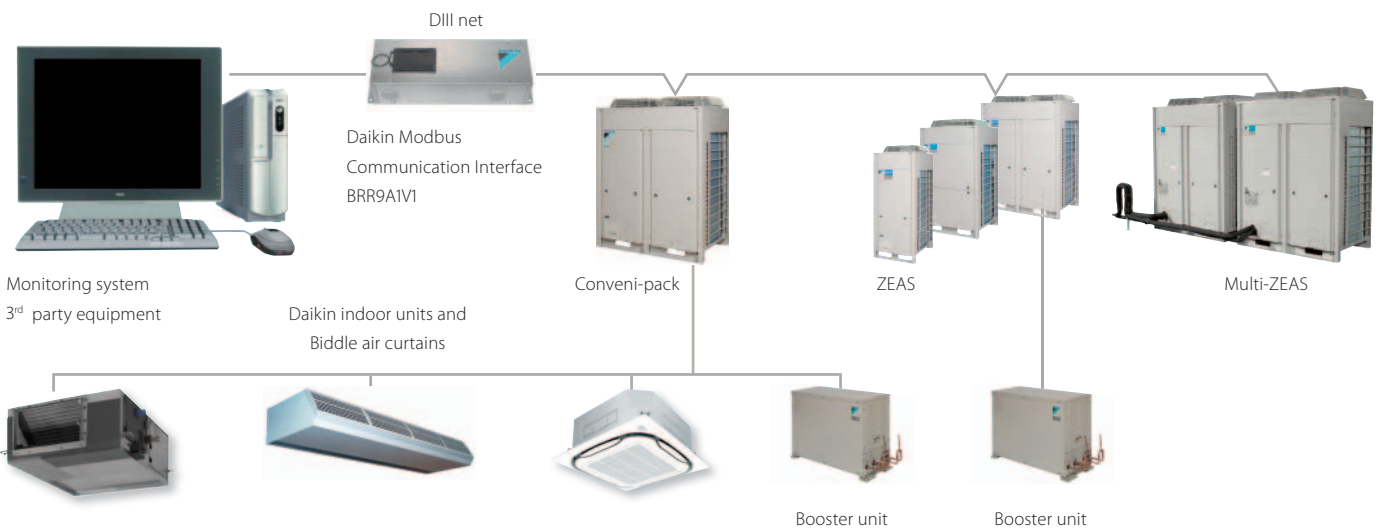

* For all connectable indoor units and Biddle air curtains please refer to the Conveni-pack pages in this catalogue

KNX interface

KLIC-DD
KLIC-DI

Integration of Split, Sky Air and VRV in HA/BMS systems

Connect split indoor units to KNX interface for Home Automation system



Connect Sky Air / VRV indoor units to KNX interface for BMS integration

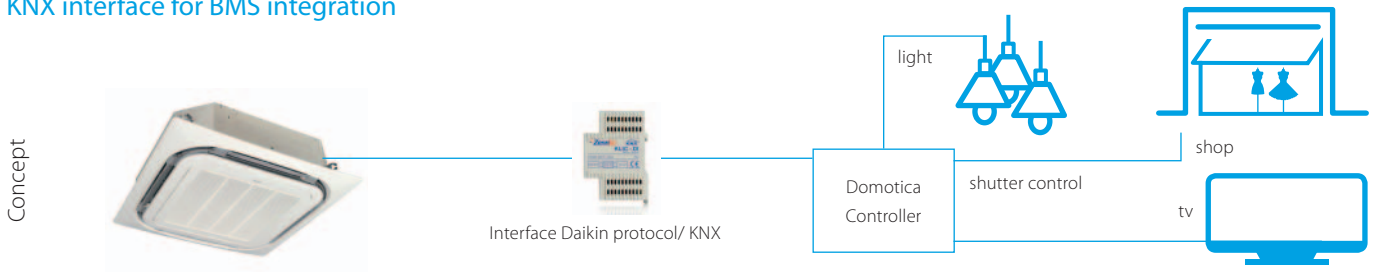



KNX interface line-up

The integration of Daikin indoor units through the KNX interface allows monitoring and control of several devices, such as lights and shutters, from one central controller. One particularly important feature is the ability to programme a 'scenario'

- such as "Home leave" - in which the end-user selects a range of commands to be executed simultaneously once the scenario is selected. For instance in "Home leave", the air conditioner is off, the lights are turned off, the shutters are closed and the alarm is on.

KNX interface for

	 KLIC-DD Size 45x45x15mm	 KLIC-DI Size 90x60x35mm	
	Split	Sky Air	VRV
Basic control			
On/Off	●	●	●
Mode	Auto, heat, dry, fan, cool	Auto, heat, dry, fan, cool	Auto, heat, dry, fan, cool
Temperature	●		●
Fan speed levels	3 or 5 + auto	2 or 3	2 or 3
Swing	Stop or movement	Stop or movement	Swing or fixed positions (5)
Advanced functionalities			
Error management	Communication errors, Daikin unit errors		
Scenes	●	●	●
Auto switch off	●	●	●
Temperature limitation	●	●	●
Initial configuration	●	●	●
Master and slave configuration		●	●

BACnet Interface

DMS502A51 / EKACBACMSTP / EKCBACIP / EKCBACMSTP

Integrated control system for seamless connection between VRV, applied systems, air handling units and BMS systems

- › Interface for BMS system
- › Communication via BACnet protocol (connection via Ethernet)
- › Unlimited sitesize
- › Easy and fast installation
- › PPD data is available on BMS system (only for VRV)

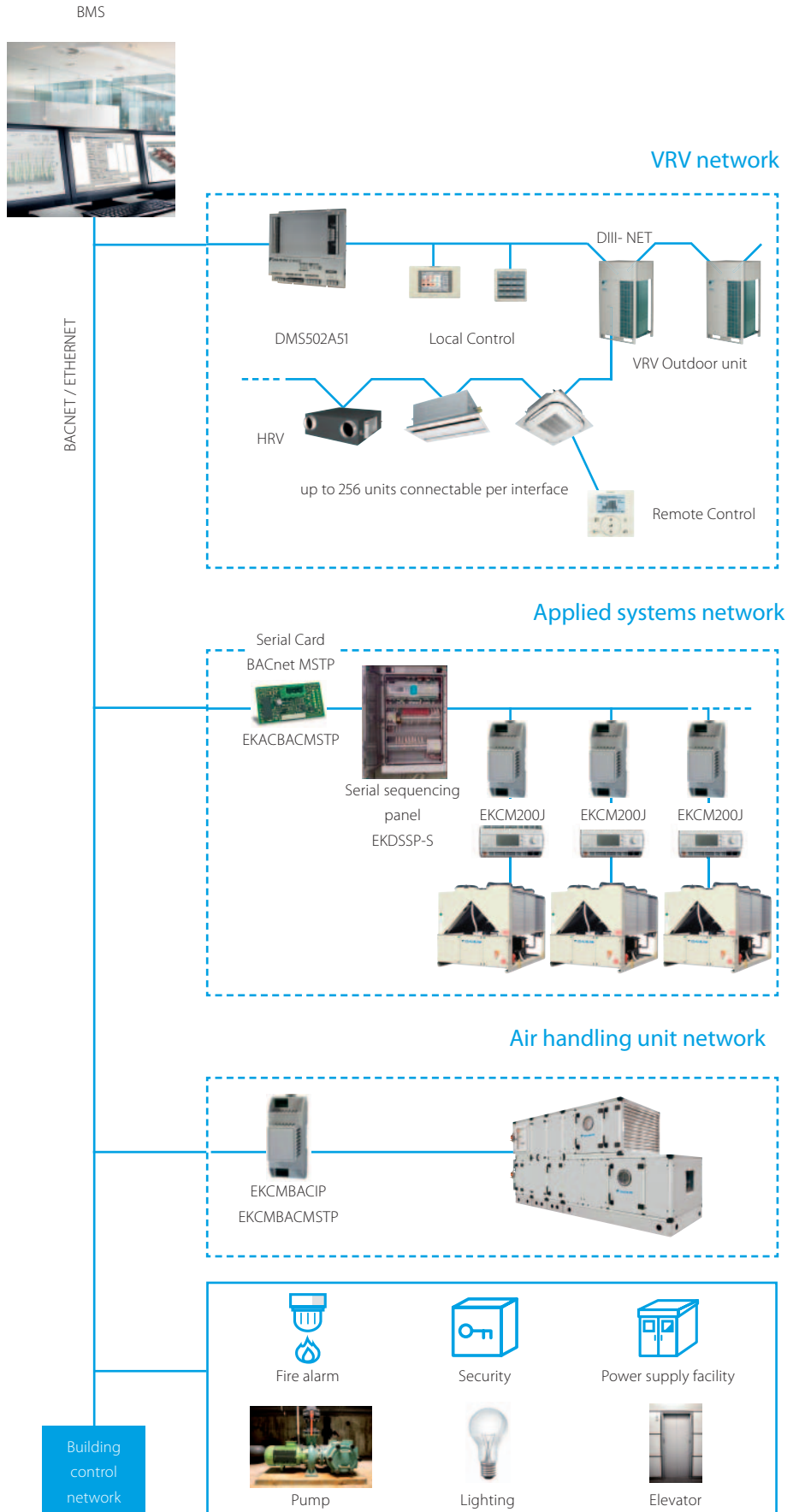

LonWorks Interface

DMS504B51 / EKACLONP

Open network integration of VRV and applied systems monitoring and control functions into LonWorks networks

- > Interface for Lon connection to LonWorks networks
- > Communication via Lon protocol (twisted pair wire)
- > Unlimited sitesize
- > Quick and easy installation

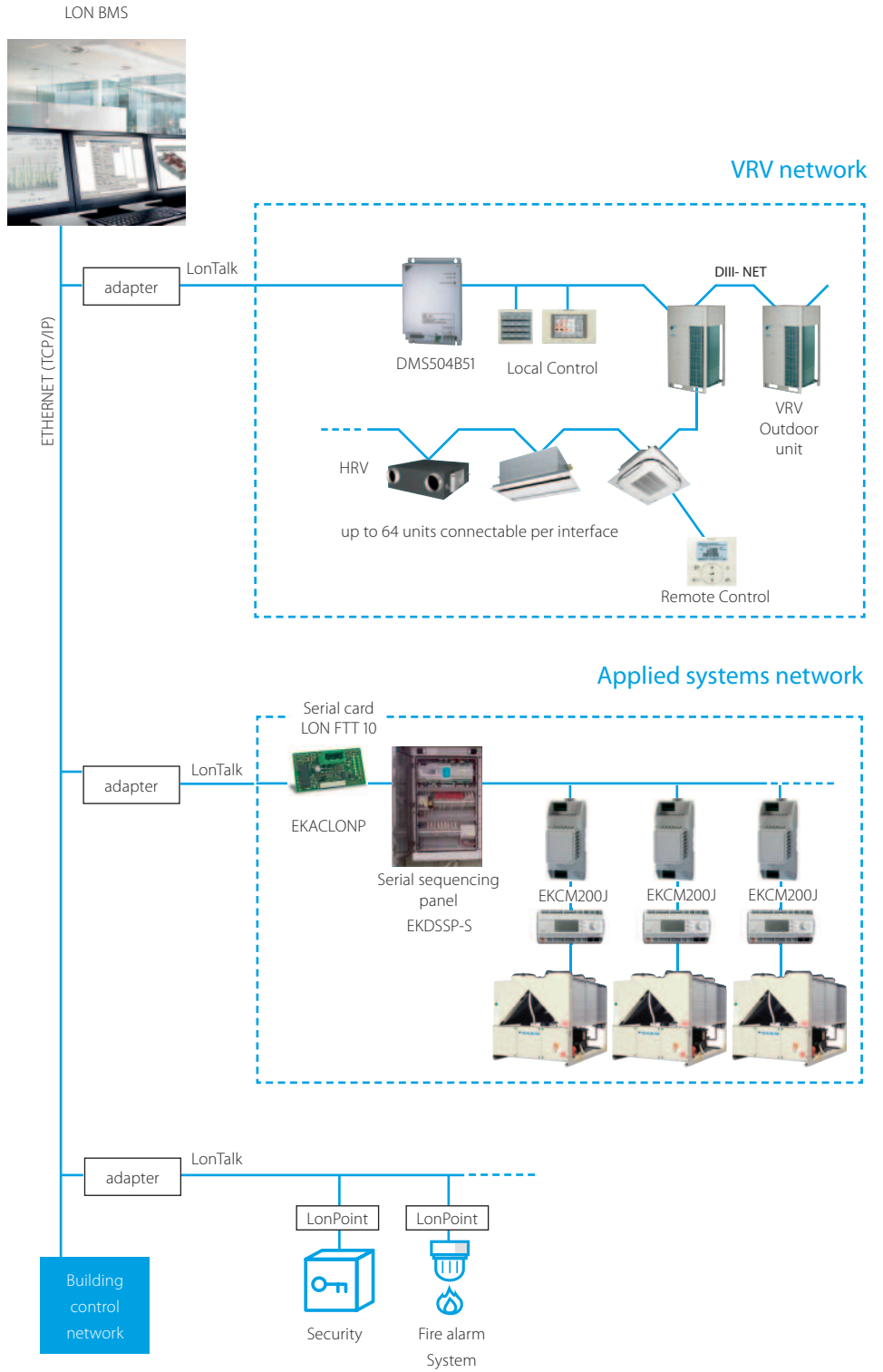

Daikin Configurator Software

EKPCCAB3

Simplified commissioning:
graphical interface to configure, commission
and upload system settings

Simplified commissioning

The Daikin configurator for Daikin Altherma and VRV is an advanced software solution that allows for easy system configuration and commissioning:

- › Less time is required on the roof configuring the outdoor unit
- › Multiple systems at different sites can be managed in exactly the same way, thus offering simplified commissioning for key accounts
- › Initial settings on the outdoor unit can be easily retrieved



Simplified
commissioning



Retrieve initial
system settings



What is I-Net?

A service based on our global remote monitoring technology, keeping your system trouble-free and working with top efficiency.

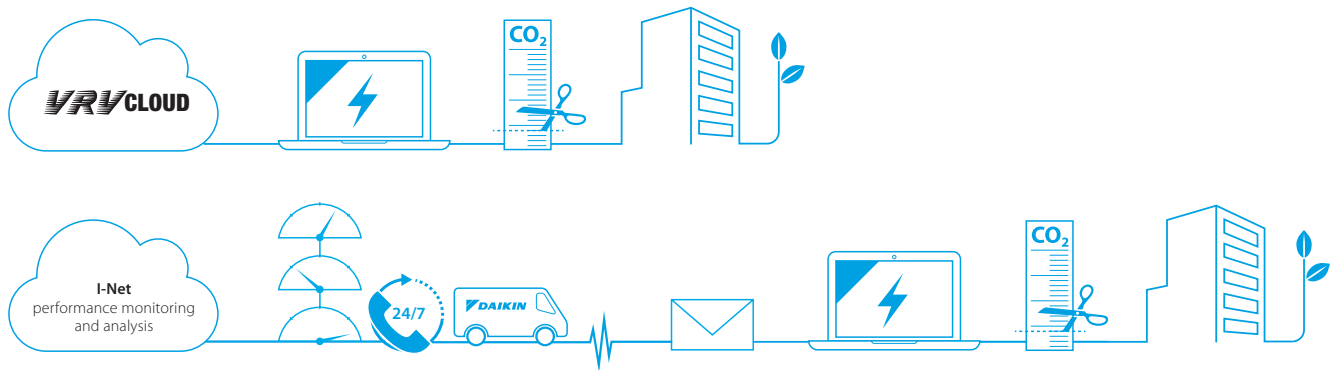

What does I-Net offer you

Safeguarding the lifelong optimum operation of your air conditioning system means getting geared up to operate the system in a energy efficient way and reduce unexpected breakdowns and costs to the absolute minimum. This is where I-Net helps to improve the effectiveness of your building management.

I-Net is about 'being connected' with Daikin, the Internet-based link between you, your air conditioning system and Daikin's Remote Monitoring Centre. This allows you to monitor your energy consumption and Daikin's expert service engineers to monitor your entire system's status non-stop, all year round. Through predicting malfunctions and offering technical advice from data analysis, you can maximise equipment uptime, as well as controlling energy costs with no sacrifice in comfort levels. By doing this, i-Net will prevent problems, prolong your system's service life while reducing the energy bill.

I-Net Services

i-Net consists of 2 main services: the VRV Cloud and I-Net performance monitoring and analysis.

VRV Cloud

The VRV Cloud puts you in the driving seat of your energy management. The easy-to-use energy data trending and analytic tools puts you in control and shows you CO₂ footprint reduction opportunities and energy savings of up to 15%.

Saving starts by measuring. Enhance your company's sustainability !

I-Net performance monitoring and analysis

Focus on your core business and hand the HVAC over to Daikin. Daikin I-Net connects your system continuously with Daikin. It notifies alarms and early warnings of system deviations to maximise system uptime and the comfort of the people in the building. Service providers have webbased access to operation data so that they are fully prepared when they arrive on-site. Specialists run trend analyses. All of which boosts your system's reliability by ensuring that it is running at optimum efficiency.

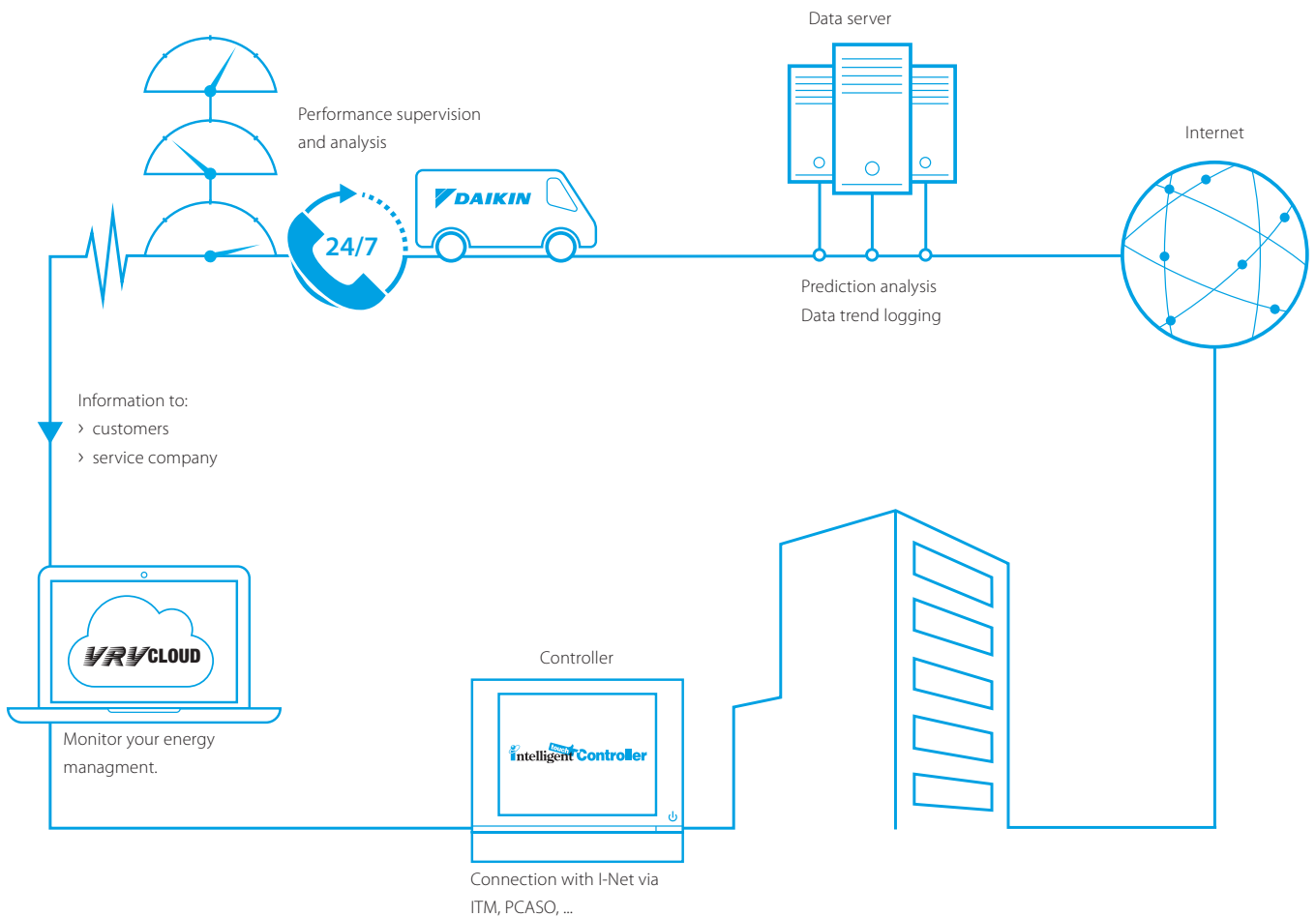

Daikin VRV Cloud

Helps you manage your energy through Daikin technology.

- > Intelligent energy visualization tool that helps you with your energy management
- > 24/7 online monitoring by the customer from any location.
- > User friendly visualization of VRV energy management (kWh)
- > Analysis support of waste operation
- > Multiple site monitoring

- > Performance Supervision by Daikin experts enhances a maintenance plan.
- > This service aims to enhance the service level, to respond fast and accurate, to save on unexpected repair costs and assure the peace of mind. Repetitive interventions and disturbance of building tenants and maintenance teams are kept to a minimum.

Long lifetime systems

- > I-Net will maximise the installation's lifetime, by assuring the equipment runs in optimal conditions and avoid unnecessary stress on components.

Performance monitoring

Daikin's unique I-Net Service aims to prevent the equipment coming to an unexpected stop or needing emergency repair.

Fast response, better prepared

- > If an alarm does occur, the service provider is immediately alerted and receives all crucial information.
- > Early fault indication (predictions) : operation data are 24/7 checked by I-Net prediction algorithms to act as early as possible, averting unscheduled breakdowns.

Analysis

Be connected with Daikin's experts, this gives you a clear overview of operability and use of the air conditioning system.

- > Daikin continuously monitors energy, operation and comfort data. Thanks to periodic analysis of the data, Daikin can suggest ways of improving performance.
- > if there is a problem, Daikin specialists will analyse the operation data history to provide remote support.

Wireless room temperature sensor

K.RSS



Flexible and easy installation

- › Accurate temperature measurement thanks to flexible placement of the sensor
- › No need for wiring
- › No need to drill holes
- › Ideal for refurbishment

Connection diagram Daikin indoor unit PCB (FXSQ example)



Specifications

		Wireless room temperature sensor kit (K.RSS)	
		Wireless room temperature receiver	Wireless room temperature sensor
Dimensions	mm	50 x 50	ø 75
Weight	g	40	60
Power supply		16VDC, max. 20 mA	N/A
Battery life		N/A	+/- 3 years
Battery type		N/A	3 Volt Lithium battery
Maximum range	m		10
Operation range	°C		0~50
Communication	Type		RF
	Frequency	MHz	868.3

- › Room temperature is sent to the indoor unit every 90 seconds or if the temperature difference is 0.2°C or larger.

Wired room temperature sensor

KRCS01-1B
KRCS01-4B



- › Accurate temperature measurement, thanks to flexible placement of the sensor

Specifications











Dimensions (HxW)	mm	60 x 50
Weight	g	300
Length of branch wiring	m	12

ADAPTER PCBs

Simple solutions for unique requirements



Concept and benefits

- › Low cost option to satisfy simple control requirements
- › Deployed on single or multiple units

			Connectable to:		
			Split	Sky Air	VRV
	(E)KRP1B* adapter for wiring	<ul style="list-style-type: none"> • Facilitates integration of auxiliary heating apparatus, humidifiers, fans, damper • Powered by and installed at the indoor unit 		•	•
	KRP2A*/KRP4A* Wiring adapter for electrical appendices	<ul style="list-style-type: none"> • Remotely start and stop up to 16 indoor units (1 group) (KRP2A* via P1 P2) • Remotely start and stop up to 128 indoor units (64 groups) (KRP4A* via F1 F2) • Alarm indication/ fire shut down • Remote temperature setpoint adjustment • Cannot be used in combination with a central controller 		•	•
	KRP58M3	<ul style="list-style-type: none"> • Low noise and demand control option for RZQ200/250C 		•	
	SB.KRP58M51	<ul style="list-style-type: none"> • Low noise and demand control option for RZQG and RZQSG single phase • Includes mounting plate EKMKA1 		•	
	KRP58M51	<ul style="list-style-type: none"> • Low noise and demand control option for RZQG1 and RZQSG 3 phase 		•	
	DTA104A* Outdoor Unit External Control Adapter	<ul style="list-style-type: none"> • Individual or simultaneous control of VRV system operating mode • Demand control of individual or multiple systems • Low noise option for individual or multiple systems 			•
	DCS302A52 Unification adapter for computerized control	<ul style="list-style-type: none"> • Enables unified display (operation/malfunction) and unified control (ON/OFF) from BMS system • Must be used together with Intelligent Touch Controller • Cannot be combined with KRP2/4* • Can be used for all VRV indoor models 			•
	KRP928* Interface adapter for DIII-net	<ul style="list-style-type: none"> • Allows integration of split units to Daikin central controls 	•		
	KRP413* Wiring adapter normal open contact / normal open pulse contact	<ul style="list-style-type: none"> • Switch off auto restart after power failure • Indication of operation mode / error • Remotely start /stop • Remotely change operation mode • Remotely change fan speed 	•		
	KRP980* Adapter for split units without an S21 port	<ul style="list-style-type: none"> • Connect a wired remote control • Connect to Daikin central controls • Allow external contact 	•		

Some adapters require an installation box, refer to the option lists for more information

Accessories

EKRORO		<ul style="list-style-type: none"> • External ON/OFF or forced off • Example: door or window contact
EKRORO 3		<ul style="list-style-type: none"> • External ON/OFF or forced off • F1/F2 contact • Example: door or window contact
KRC19-26A		<ul style="list-style-type: none"> • Mechanical cool/heat selector • Allows switching over an entire system between cooling/heating/fan only • Connects to the A/B/C terminals of the unit
BRP2A81		<ul style="list-style-type: none"> • Cool/heat selector PCB • Required to connect KRC19-26A to a VRV IV outdoor unit

Daikin touch control with cloud connection

		Daikin touch control with cloud connection		
		Options for local control	Cloud options	Software
Zenpad 8" Tablet for local control	Z380C	●	-	-
Asus 4G-N12 router	4G-N12	●	-	-
Online control - for remote monitoring and control	DCC001A51	-	●	-
Multi site – for remote monitoring, control and comparison of multiple sites (needed for each site)	DCC002A51	-	●	-
Energy saving – activates automatic energy saving function	DCC003A51	-	●	-
Full – contains packs DCC001/002/003A51	DCC004A51	-	●	-
App for tablet – Application to run on Z380C tablet (download from Play store, Android only)		-	-	●
Commissioning tool		-	-	●
Software update tool		-	-	●

Intelligent Touch Manager

			
		Options & software	
iTM plus adapter – Allows connection of an additional 64 indoor units/groups. Up to 7 adapters can be connected	DCM601A52	●	
iTM ppd software – Allows distribution of used kWh by indoor units connected to the iTM	DCM002A51	●	
iTM energy navigator – Energy management option	DCM008A51	●	
iTM BACnet option – Enables connection of third party devices to the iTM via the BACnet protocol. (This is not a gateway and cannot replace DMS502B51)	DCM009A51	●	

Standard protocol interfaces

		DMS504B51	DMS502A51
		LonWorks Interface	BACnet Interface
Interface adapter for connection to RA units	KRP928A25	●	●
Interface adapter for connection to R-407C/R-22 Sky Air units	DTA102A52	●	●
Interface adapter for connection to R-410A Sky Air units	DTA112B51	●	●
DIII board	DAM411B51	-	●
Digital input/output	DAM412B51	-	●

Power supply

T1	=	3~, 220V, 50Hz
V1	=	1~, 220-240V, 50Hz
VE	=	1~, 220-240V/220V, 50Hz/60Hz*
V3	=	1~, 230V, 50Hz
VM	=	1~, 220~240V/220~230V, 50Hz/60Hz
W1	=	3N~, 400V, 50Hz
Y1	=	3~, 400V, 50Hz

* For VE power supply only 1~, 220-240V, 50Hz data is displayed in this catalogue.

Conversion table refrigerant piping

inch	mm
1/4"	6.4 mm
3/8"	9.5 mm
1/2"	12.7 mm
5/8"	15.9 mm
3/4"	19.1 mm
7/8"	22.2 mm
1 1/8"	28.5 mm
1 3/8"	34.9 mm
1 5/8"	41.3 mm
1 3/4"	44.5 mm
2"	50.8 mm
2 1/8"	54 mm
2 5/8"	66.7 mm

F-gas regulation

For fully/partially charged equipment: contains fluorinated greenhouse gases. Actual refrigerant charge depends on the final unit construction, details can be found on the unit labels.

For non pre-charged equipment (Chillers: split chiller (SEHVX/SERHQ), condensing units and condenserless chillers + refrigeration (LCBKQ-AV1, JEHCCU/JEHSCU and ICU): Its functioning relies on fluorinated greenhouse gases.

Measuring conditions

Air conditioning

1) Nominal cooling capacities are based on:	
Indoor temperature	27°CDB/19°CWB
Outdoor temperature	35°CDB
Refrigerant piping length	7.5m - 8/5m VRV
Level difference	0m
2) Nominal heating capacities are based on:	
Indoor temperature	20°CDB
Outdoor temperature	7°CDB/6°CWB
Refrigerant piping length	7.5m - 8/5m VRV
Level difference	0m

Applied systems

Air cooled	Cooling only	Evaporator: 12°C/7°C	Ambient: 35°CDB
	Heat pump	Evaporator: 12°C/7°C Condenser: 40°C/45°C	Ambient: 35°C Ambient: 7°CDB/6°CWB
Water cooled	Cooling only	Evaporator: 12°C/7°C Condenser: 30°C/35°C	
	Heating only	Evaporator: 12°C/7°C Condenser: 40°C/45°C	
Condenserless chiller		Evaporator: 12°C/7°C Condensing temperature: 45°C / liquid temperature: 40°C	
Fan coil units	Cooling	Room temperature: 27°CDB /19°CWB Water inlet/outlet temperature: 7°C/12°C	
	Heating	Room temperature: 20°C 2 pipe: Water inlet temperature: 50°C (same water flow as in cooling mode) 4 pipe: Water inlet/outlet temperature: 70°C/60°C	

The sound pressure level is measured via a microphone at a certain distance from the unit. It is a relative value, depending on the distance and acoustic environment (for measuring conditions: please refer to the technical databooks).

The sound power level is an absolute value indicating the "power" which a sound source generates.

For more detailed information please consult our technical databooks.

Benefits

We care icons



Seasonal efficiency, smart use of energy

Seasonal efficiency gives a more realistic indication on how efficient air conditioners operate over an entire heating or cooling season.



Auto-cleaning filter

The filter automatically cleans itself once per day. Simplicity of upkeep means optimum energy efficiency and maximum comfort without the need for expensive or time-consuming maintenance.



Inverter technology

In combination with inverter controlled outdoor units



2 area intelligent eye

Air flow is sent to a zone other than where the person is located at that moment. Detection is done in 2 directions: left and right. If no people are detected, the unit will automatically switch over to the energy-efficient setting.



3 area intelligent eye

Air flow is sent to a zone other than where the person is located at that moment. Detection is done in 3 directions: left, front and right. If no people are detected, the unit will automatically switch over to the energy-efficient setting and eventually switch off.



Energy saving during operation standby

Current consumption is reduced by about 80 % when operating on standby.



Night set mode

Saves energy, by preventing overcooling or overheating during night time.



Econo mode

This function decreases the power consumption so that other appliances that need large power consumption can be used. This function is also energy saving.



Movement sensor

The sensor detects whether someone is in the room. When the room is empty, the unit switches to economy mode after 20 minutes and restarts when a person enters the room.



Home leave operation

During absence, the indoor temperature can be maintained at a certain level.



Fan only

The air conditioner can be used as fan, blowing air without cooling or heating.



Free cooling

By exploiting the low external air temperatures to cool the water, free cooling reduces the load on the compressors and decreases considerably the annual operating costs during the cold season.



Floor & presence sensor

The presence sensor directs the air away from any person detected in the room, when the air flow control is on. The floor sensor detects the average floor temperature and ensures an even temperature distribution between ceiling and floor.

Comfort



Comfort mode

The unit automatically changes the angle of the air discharge louvre depending on the mode. In cooling operation the air will be directed rather upwards to avoid cold draught, while in heating operation the air will be directed rather downwards to avoid cold feet.



Powerful mode

If the temperature in the room is too high/low, it can be cooled down/heated quickly by selecting the 'powerful mode'. After the powerful mode is turned off, the unit returns to the preset mode.



Whisper quiet

Daikin units are whisper quiet. (with sound levels as low as 19dB(A))



Outdoor unit silent operation

To ensure a quiet environment for the neighbourhood the user can lower the operation sound of the outdoor unit by 3 dB(A) via remote control.



Comfortable sleeping mode

Increased comfort function that follows a specific temperature fluctuation rhythm.



Integrated cooling

Remove in a reliable, efficient and flexible way the heat constantly generated by the IT and server equipment to ensure maximum uptime while offering the best return on investment.



Draught prevention

When starting to warm up or when the thermostat is off, the air discharge direction is set horizontally and the fan to low speed, to prevent draught. After warming up, air discharge and fan speed are set as desired.



Auto cooling-heating changeover

Automatically selects cooling or heating mode to achieve the set temperature (heat pump types only).



Indoor unit silent operation

To ensure a quiet environment for studying or sleeping the user can lower the operation sound of the indoor unit by 3 dB(A) via remote control.



Night quiet mode (cooling only)

Lowers the operation sound of the outdoor unit automatically at night. Installer has to make special setting on outdoor unit or wired remote controller, depending on model.



Radiant heat

The front panel of the indoor unit radiates additional heat to add to your comfort on cold days

Air flow



Ceiling soiling prevention

A special function prevents air blowing out too long in horizontal position, to prevent ceiling stains.



Vertical auto swing

Possibility to select automatic vertical moving of the air discharge louvre, for uniform air flow and temperature distribution.



Auto fan speed

Automatically selects the necessary fan speed to reach or maintain the set temperature.



3-D Air flow

This function combines Vertical and Horizontal auto-swing to circulate a stream of cool/warm air right to the corners of even large spaces.



Horizontal auto swing

Possibility to select automatic horizontal moving of the air discharge louvre, for uniform air flow and temperature distribution.



Fan speed steps

Allows to select up to the given number of fan speed.



Individual flap control

Flexible installation thanks to the possibility of easily closing one flap via the wired remote controller, to suit any new room configuration. Optional closure kits are available as well.

Benefits

Humidity control



Ururu - humidification

Moisture is absorbed from the outdoor air and evenly distributed throughout the indoor areas.



Dry programme

Allows humidity levels to be reduced without variations in room temperature.



Sarara - dehumidification

Reduces indoor humidity, without affecting the room temperature, by mixing cool, dry air with warm air.

Air treatment



Flash streamer

The Flash Streamer generates high-speed electrons that powerfully break down odours and formaldehyde.



Photocatalytic deodorising filter

Removes airborne dust particles, decomposes odours and restrains the reproduction of bacteria, viruses and microbes, this to ensure a steady supply of clean air.



Titanium photocatalytic air purification filter

Removes airborne dust particles, and decomposes the odours of for example tobacco and pets. It also decomposes harmful organic chemical substances such as bacteria, viruses and allergens.



Air filter

Removes airborne dust particles to ensure a steady supply of clean air.

Remote control & timer



Weekly timer

Timer can be set to start operation anytime on a daily or weekly basis.



Timer

Allows to preset the air conditioner to start/stop at a specified time.



Wired remote control

Wired remote control to start, stop and regulate the air conditioner from a distance.



24 Hour timer

Timer can be set to start cooling/heating anytime during a 24-hour period.



Infrared remote control

Infrared remote control with LCD to start, stop and regulate your indoor unit from a distance.



Centralised control

Centralised control to start, stop and regulate several indoor units from one central point.



Online controller via app

Control your indoor unit from any location via app. (optional WLAN adapter)

Other functions



Auto-restart

The unit restarts automatically at the original settings after power failure.



Twin/triple/double twin application

2, 3 or 4 indoor units can be connected to only 1 outdoor unit even if they have different capacities. All indoor units operate within the same mode (cooling or heating) from one remote control.



VRV for residential application

Up to 9 indoor units (even different capacities and up to 71 class) can be connected to a single outdoor unit. All indoor units can individually be operated within the same mode.



Multi tenant

The indoor unit's main power supply can be turned off when leaving the hotel or office building.



Scroll compressor

Scroll compressors consist of two scrolls, one is fixed while the other orbits eccentrically without rotating. Designed for small and medium capacities, they provide constant reliability and high efficiency throughout its service life.



Centrifugal compressor

Centrifugal compressors use an impeller and volute section to convert the velocity energy into pressure energy. Centrifugal compressors are designed with either optional variable speed drives (VFD) for superior part-load performance for single or dual compressor units, or with magnetic bearings and totally oil-free operation.



Guaranteed operation down to -20°C

Daikin heat pumps are suitable for all climates, even withstanding severe winter conditions with an operation range down to -20°C



Self-diagnosis

Simplifies maintenance by indicating system faults or operating anomalies.



Multi model application

Up to 5 indoor units (even different capacities) can be connected to a single outdoor unit. All indoor units can individually be operated within the same mode.



Drain pump kit

Facilitates condensation draining from the indoor unit.



Swing compressor

Swing type compressors have a unified vane and roller with fewer moving parts producing low vibration and friction, achieve higher reliability and efficiency compared to conventionally rotary compressors.



Screw compressor

Single screw compressors consist of a main single screw and two gate rotors. Optimal performance through step less capacity control, they are designed for high capacities and optimal performances.



Reciprocating compressor

The reciprocating type compressor consists of a cylinder, pistons and valves. The compression is accomplished by reciprocating movements of the piston in the cylinder.



Guaranteed operation down to -25°C

Daikin heat pumps are suitable for all climates, even withstanding severe winter conditions with an operation range down to -25°C

New business portal



Easy search / Personalised / Mobile

Easy to do business with

We are setting new standards in customer support. With the introduction of our cutting-edge business portal, our solutions are just a click away.

Our new business portal is built around your needs, enabling you to find information quickly and easily. Our aim is that you find the information you need in seconds.

To make life even easier for you, our portal is accessible no matter where you are, via desktop, tablet and smartphone.

Discover and enjoy using our business portal at my.daikin.eu

my.daikin.eu

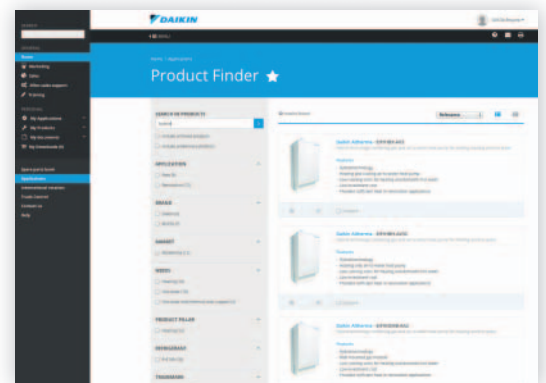

Daikin Europe N.V. Naamloze Vennootschap Zandvoordestraat 300 · 8400 Oostende · Belgium · www.daikin.eu · BE 0412 120 336 · RPR Oostende (Responsible Editor)

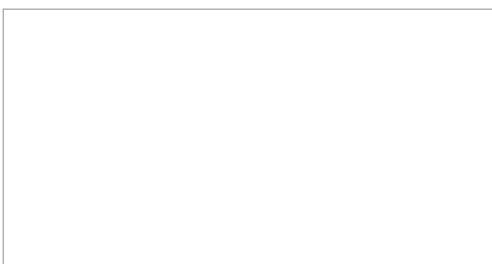

ECPEN16-500

CD · 10/16



Daikin Europe N.V. participates in the Eurovent Certification programme for Liquid Chilling Packages (LCP), Air handling units (AHU), Fan coil units (FCU) and variable refrigerant flow systems (VRF) Check ongoing validity of certificate online: www.eurovent-certification.com or using: www.certiflash.com

The present publication is drawn up by way of information only and does not constitute an offer binding upon Daikin Europe N.V. Daikin Europe N.V. has compiled the content of this publication to the best of its knowledge. No express or implied warranty is given for the completeness, accuracy, reliability or fitness for particular purpose of its content and the products and services presented therein. Specifications are subject to change without prior notice. Daikin Europe N.V. explicitly rejects any liability for any direct or indirect damage, in the broadest sense, arising from or related to the use and/or interpretation of this publication. All content is copyrighted by Daikin Europe N.V.

The present publication supersedes ECPEN15-500_P. Printed on non-chlorinated paper.